

5. Appendixes

Appendix A Investigation and Hearing

Investigation

The National Transportation Safety Board was initially notified of this accident about 2050 eastern daylight time on July 17, 1996. A full go-team was assembled in Washington, D.C., and arrived on scene early the next morning; investigators from the Safety Board's regional office in Parsippany, New Jersey, went immediately to the scene of the accident. The go-team was accompanied by the Safety Board Vice Chairman and representatives from the Safety Board's Office of Government and Public Affairs.

The following investigative groups were formed during the course of this investigation: Systems, Structures, Maintenance Records, Airplane Interior Documentation, Witness, Metallurgy Structures/Sequencing, Medical Forensic, Fire and Explosion, Powerplants, Air Traffic Control, Operations, Aircraft Performance, Airport Security, Reconstruction, Hazardous Materials—Security, and Flight Test. Specialists were also assigned to stand by in the Safety Board laboratories for the cockpit voice recorder and flight data recorder.

Parties to the investigation were the Federal Aviation Administration (FAA); the Boeing Commercial Airplane Group; Trans World Airlines, Inc. (TWA); the International Association of Mechanists, Aerospace Workers, and Flight Attendants (IAM); the Air Line Pilots Association (ALPA); the National Air Traffic Controllers Association; Pratt & Whitney; Honeywell; and the Crane Company, Hydro-Aire, Inc. (For information about agencies and companies that assisted during the search and recovery operation, see appendix C.)

Additionally, representatives from France's Bureau Enquetes Accidents, the United Kingdom's Air Accidents Investigation Branch, and Australia's Bureau of Air Safety Investigations participated in the investigation as observers, in accordance with the provisions of Annex 13 to the Convention on International Civil Aviation. In addition, representatives from Canada's Transportation Safety Board and International Civil Aviation Organization, Singapore's Civil Aviation Authority, and Russia's Interstate Aviation Committee observed portions of the investigation.

Public Hearing

A public hearing was conducted for this accident from December 8 through 12, 1997, in Baltimore, Maryland. Chairman Jim Hall presided over the hearing. Parties to the public hearing were the FAA; Boeing; TWA; IAM; ALPA; Honeywell; and the Crane Company, Hydro-Aire.

Appendix B

Cockpit Voice Recorder Transcript

The following is a transcript of the Fairchild A-100 cockpit voice recorder (CVR) installed on the accident airplane. Only radio transmissions to and from the accident airplane were transcribed. The CVR transcript reflects the 31 minutes and 30 seconds before power was lost to the CVR. All times are eastern daylight time, based on a 24-hour clock.

Transcript of a Fairchild Model A-100 Cockpit Voice Recorder S/N UNK which was removed from a Trans World Airlines, Inc., Boeing Commercial Aircraft Co. B747-100 N93119, which was involved in an inflight accident on July 17, 1996 approximately 10 miles south of East Moriches, New York.

LEGEND

RDO	Radio transmission from accident aircraft
CAM	Cockpit Area Microphone sound or source
INT	Aircraft flight/ground intercom sound or source
-1	Voice identified as Captain (left seat)
-2	Voice identified as First Officer (right seat)
-3	Voice identified as Second Officer
-4	Voice identified as Instructor Flight Engineer
-5	Voice identified as gate agent personnel
-6	Voice identified as male aircraft ground personnel
-?	Voice unidentified
TWR	JFK Local Controller (tower)
GND	JFK Ground Controller
DEP	New York Radar Departure Controller
FIC	TWA Flight Information Controller
GH	Kennedy Gate Hold Controller
CTR	Boston ARTCC Controller (center)
LOAD	TWA passenger/freight load Controller
ATIS	Kennedy automated terminal information service
UNK	Unknown source
*	Unintelligible word
@	Nonpertinent word
#	Expletive deleted

%	Break in continuity
()	Questionable text
(())	Editorial insertion
-	Pause

Note: All times are expressed in Eastern Daylight Savings time. Only radio transmissions to and from the accident aircraft were transcribed.

CVR Quality Rating Scale

The levels of recording quality are characterized by the following traits of the cockpit voice recorder information:

Excellent Quality	Virtually all of the crew conversations could be accurately and easily understood. The transcript that was developed may indicate only one or two words that were not intelligible. Any loss in the transcript is usually attributed to simultaneous cockpit/radio transmissions that obscure each other.
Good Quality	Most of the crew conversations could be accurately and easily understood. The transcript that was developed may indicate several words or phrases that were not intelligible. Any loss in the transcript can be attributed to minor technical deficiencies or momentary dropouts in the recording system or to a large number of simultaneous cockpit/radio transmissions that obscure each other.
Fair Quality	The majority of the crew conversations were intelligible. The transcript that was developed may indicate passages where conversations were unintelligible or fragmented. This type of recording is usually caused by cockpit noise that obscures portions of the voice signals or by a minor electrical or mechanical failure of the CVR system that distorts or obscures the audio information.
Poor Quality	Extraordinary means had to be used to make some of the crew conversations intelligible. The transcript that was developed may indicate fragmented phrases and conversations and may indicate extensive passages where conversations were missing or unintelligible. This type of recording is usually caused by a combination of a high cockpit noise level with a low voice signal (poor signal-to-noise ratio) or by a mechanical or electrical failure of the CVR system that severely distorts or obscures the audio information.
Unusable	Crew conversations may be discerned, but neither ordinary nor extraordinary means made it possible to develop a meaningful transcript of the conversations. This type of recording is usually caused by an almost total mechanical or electrical failure of the CVR system.

<u>INTRA- COCKPIT COMMUNICATION</u>	
<u>TIME and SOURCE</u>	<u>CONTENT</u>
1959: 40	Start of recording.
1959: 41 CAM-?	got it.
1959: 42 CAM-?	an agent comin'.
1959: 43 CAM-?	yeah right.
1959: 44 CAM- 5	passenger's bag pulled, the passenger was on board the whole time.
1959: 49 CAM- 5	all right.
1959: 50 CAM-1	is the bags back on?
1959: 52 CAM- 5	huh?
1959: 53 CAM-?	yes.

AIR- GROUND COMMUNICATION

<u>TIME and SOURCE</u>	<u>CONTENT</u>
------------------------	----------------

INTRA- COCKPIT COMMUNICATION

AIR- GROUND COMMUNICATION

<u>TIME and SOURCE</u>	<u>CONTENT</u>
1959: 53 CAM- 1	yeah he was on the whole time.
1959: 54 CAM- 1	okay.
1959: 56 CAM- 4	are we reconciled?
1959: 56 CAM-?	let's go.
1959: 58 CAM-?	push.
1959: 59 CAM	((sound similar to cockpit door closing)).
2000: 01 CAM- 1	we won't bother telling them that.
2000: 03 CAM-?	nope.
2000: 04 CAM- 1	you don't mind, huh?
2000: 11 CAM- 3	we'd have a mutiny back there.

<u>INTRA- COCKPIT COMMUNICATION</u>	
<u>TIME and SOURCE</u>	<u>CONTENT</u>
2000: 14 CAM- 4	now the lavatories are full.
2000: 15 CAM- 1	okay, well she said she'd call me as soon as they ah --.
2000: 16 CAM- 3	probably have to get the ATIS now, huh?
2000: 18 CAM- 2	don't don't ah let them do their job Ralph they'll tell you when they're seated.
2000: 22 ATIS	-- visibility greater than one zero ceiling better than five thousand temperature two eight due point two one altimeter three zero zero seven approach in use VOR DME runway two two left departure runway runway two two right and southwest departures runway three one left from intersection of kilo kilo all pilot are require to read back all runway hold short instructions in interest of noise abatement please use the assigned runway advise you have tango Kennedy airport information tango two three five one Zulu weather wind two two zero eight visibility --.
2000: 36 CAM- 3	all door lights are out.
2000: 37 CAM- 1	thank you.

AIR- GROUND COMMUNICATION

<u>TIME and SOURCE</u>	<u>CONTENT</u>
------------------------	----------------

<u>INTRA- COCKPIT COMMUNICATION</u>		<u>AIR- GROUND COMMUNICATION</u>	
<u>TIME and SOURCE</u>	<u>CONTENT</u>	<u>TIME and SOURCE</u>	<u>CONTENT</u>
2000: 53 CAM- 2	tango.		
		2001: 02 INT- 6	cockpit ground.
		2001: 05 INT- 1	hello ground
		2001: 06 INT- 6	all right every thing is shut down here you should have all doo lights out and when you have clearance you can release the brakes.
		2001: 13 INT- 1	yeah we'll get the clearance we're waitin' on all the people to sit down I'll be back with ya in just a second.
2001: 18 CAM	((sound of cabin chime)).		
		2000: 40 INT- 6	okay we're standing by.
2001: 23 CAM- 3	hello darling.		
2001: 24 CAM- 3	everybody seated thanks.		

<u>INTRA- COCKPIT COMMUNICATION</u>	
TIME and SOURCE	CONTENT
2001: 25 CAM- 1	amazing.
2001: 26 CAM- 3	everybody's seated.
2001: 27 CAM- 1	do we have push back clearance to move?
2001: 28 CAM- 3	we're we're we cleared to push from FIC or -.
2001: 30 CAM- 1	no not yet.
2001: 31 CAM- 2	you have to call them.

<u>AIR- GROUND COMMUNICATION</u>	
TIME and SOURCE	CONTENT
2001: 32 RDO- 3	FIC TWA eight hundred gate twenty seven.
2001: 37 FIC	TWA eight hundred?
2001: 38 RDO- 3	yeah we're ready to push.

INTRA- COCKPIT COMMUNICATION

<u>TIME and SOURCE</u>	<u>CONTENT</u>
2001: 39 CAM	((sound of electric seat adjustment)).
2001: 46 CAM- 2	cleared to push.
2001: 47 CAM- 1	cleared to push.
2001: 53 CAM- 1	did they say everybody was seated yeah they did.
2001: 54 CAM- 3	yes.

AIR- GROUND COMMUNICATION

<u>TIME and SOURCE</u>	<u>CONTENT</u>
2001: 42 FIC	TWA eight hundred you're cleared to push gate twenty seven.
2001: 48 RDO- 3	cleared to to push eight hundred.
2001: 50 INT- 1	okay ground we are cleared to push yeah well wait a minute hang on a minute.
2001: 58 INT- 1	okay, we're cleared to push sorry.

<u>INTRA- COCKPIT COMMUNICATION</u>	
<u>TIME and SOURCE</u>	<u>CONTENT</u>
2001: 58 CAM	((sound similar to parking brake being released)).
2002: 02 CAM- 2	you got something else to do Ralph.
2002: 05 CAM- 1	number one ADP-.
2002: 06 CAM- 2	there you go.
2002: 07 CAM- 1	and the electric.
2002: 08 CAM- 2	it's a command.
2002: 09 CAM- 1	electric's on.

<u>AIR- GROUND COMMUNICATION</u>	
<u>TIME and SOURCE</u>	<u>CONTENT</u>
2001: 57 INT- 6	brakes released please.
2001: 59 INT- 1	beacon on brakes released.
2002: 00 INT- 6	thank you.

<u>INTRA- COCKPIT COMMUNICATION</u>	
<u>TIME and SOURCE</u>	<u>CONTENT</u>
2002: 10 CAM- 2	right.
2002: 10 CAM- 2	that's a command.
2002: 11 CAM- 1	command.
2049: 27 CAM- 1	number one ADP on and the electric.
2002: 16 CAM- 2	before you release the brakes.
2002: 22 CAM-?	*.
2002: 27 CAM- 2	block's at oh two I assume.
2002: 29 CAM- 3	I'm showin' oh two out. is that what you want?
2002: 32 CAM- 2	that's fine.

<u>AIR- GROUND COMMUNICATION</u>	
<u>TIME and SOURCE</u>	<u>CONTENT</u>

INTRA- COCKPIT COMMUNICATION

AIR- GROUND COMMUNICATION

<u>TIME and SOURCE</u>	<u>CONTENT</u>
2002: 33 CAM- 1	yeah.
2002: 34 CAM- 2	that's fine.
2002: 35 CAM- 1	okay.
2002: 38 CAM- 2	that's a minute over kill.
2002: 40 CAM- 1	yeah well that was because they weren't seated they probably had people standing up and they were *.
2002: 46 CAM- 2	* down.
2002: 48 CAM- 2	exactly.
2002: 50 CAM- 1	you can bet on it.
2002: 54 CAM- 1	I still think I'm sittin' too high in this thing.

<u>INTRA- COCKPIT COMMUNICATION</u>		<u>AIR- GROUND COMMUNICATION</u>	
<u>TIME and SOURCE</u>	<u>CONTENT</u>	<u>TIME and SOURCE</u>	<u>CONTENT</u>
2003: 11 CAM- 1	somebody calling us .	2003: 10 FIC	eight hundred.
		2003: 12 RDO- 3	go ahead.
		2003: 13 FIC	tell your mechanic to pull you back push you back far enough so we can get an arrival into your gate.
		2003: 18 RDO- 3	okay.
		2003: 21 INT- 1	and ah ground FIC wants you to push us back far enough so they can bring somebody in our gate.
		2003: 27 INT- 6	okay we'll do that.
		2003: 30 INT- 1	thank you.
2003: 32 CAM-?	* where's this thing.		

<u>INTRA- COCKPIT COMMUNICATION</u>	
<u>TIME and SOURCE</u>	<u>CONTENT</u>
2004: 07 CAM- 1	ah there's that ah new airplane.
2004: 10 CAM- 2	one twenty nine yes sir.
2004: 48 CAM	((sound of parking brake being set)).

<u>AIR- GROUND COMMUNICATION</u>	
<u>TIME and SOURCE</u>	<u>CONTENT</u>
2004: 43 INT- 6	okay this looks far enough.
2004: 45 INT- 1	okay if you say so.
2004: 47 INT- 6	brakes parked please.
2004: 50 INT- 1	brakes parked.
2004: 51 INT- 6	thank you cleared to turn your engines.
2004: 54 INT- 1	okay we'll turn one two and four today.
2004: 56 INT- 6	((sound of two mike clicks)).

INTRA- COCKPIT COMMUNICATION

AIR- GROUND COMMUNICATION

<u>TIME and SOURCE</u>	<u>CONTENT</u>
2004: 59 CAM- 1	turn one please.
2005: 12 CAM- 2	((sound of cough)).
2005: 19 CAM- 1	contact.
2005: 22 CAM- 2	you got N- 1?
2005: 26 CAM- 1	I do now.
2005: 27 CAM- 2	you do now.
2005: 29 CAM- 3	four fifty.
2005: 30 CAM- 1	it bobbled but not much.
2005: 42 CAM- 1	and turn two please.

<u>TIME and SOURCE</u>	<u>CONTENT</u>
-------------------------------	-----------------------

INTRA- COCKPIT COMMUNICATION

AIR- GROUND COMMUNICATION

<u>TIME and SOURCE</u>	<u>CONTENT</u>
2005: 44 CAM- 4	***.
2006: 00 CAM- 1	N- one.
2006: 01 CAM- 3	turning.
2006: 04 CAM- 1	two.
2006: 07 CAM- 3	four hundred.
2006: 24 CAM- 1	turn four.
2006: 25 INT- 1	turning four.
2006: 27 INT- 6	* four.
2006: 45 CAM- 1	contact.
2006: 51 CAM- 3	four hundred.

<u>TIME and SOURCE</u>	<u>CONTENT</u>
-------------------------------	-----------------------

<u>INTRA- COCKPIT COMMUNICATION</u>	
<u>TIME and SOURCE</u>	<u>CONTENT</u>
2007: 13 CAM- 1	okay and after start checklist when you have a moment.
2007: 14 CAM	((sound of momentary power interruption to the CVR)).
2007: 15 CAM	((sound of altitude alert tone)).
2007: 20 CAM- 3	stand by.
2007: 29 CAM- 1	after start.
2007: 30 CAM- 3	after start checklist. flight recorder?
2007: 33 CAM- 1	on.

<u>AIR- GROUND COMMUNICATION</u>	
<u>TIME and SOURCE</u>	<u>CONTENT</u>
2006: 56 INT- 1	disconnect ground equipment stand by for hand signals thank you.
2006: 58 INT- 6	okay.

INTRA- COCKPIT COMMUNICATION

<u>TIME and SOURCE</u>	<u>CONTENT</u>
2007: 34 CAM- 3	start switches?
2007: 35 CAM- 1	off.
2007: 36 CAM- 3	beacon lights?
2007: 37 CAM- 1	are on.
2007: 38 CAM- 3	brake pressure?
2007: 41 CAM- 1	checked.
2007: 42 CAM- 3	start levers?
2007: 44 CAM- 1	idle detent.
2007: 45 CAM- 3	engine anti- ice?
2007: 46 CAM- 1	off.

AIR- GROUND COMMUNICATION

<u>TIME and SOURCE</u>	<u>CONTENT</u>
-------------------------------	-----------------------

INTRA- COCKPIT COMMUNICATION

<u>TIME and SOURCE</u>	<u>CONTENT</u>
2007: 50 CAM- 1	you need to get taxi clearance.

2008: 04 CAM- 3	after start checklist complete.
--------------------	---------------------------------

AIR- GROUND COMMUNICATION

<u>TIME and SOURCE</u>	<u>CONTENT</u>
2007: 52 RDO- 2	Kennedy gate hold TWA's eight hundred heavy we're life guard ah we're ready to taxi out delta alpha with tango.
2008: 01 GH	TWA eight hundred all right contact ground one two one point niner for the taxi inform them that you are lifeguard.
2008: 07 RDO- 2	roger.
2008: 13 RDO- 2	Kennedy ground TWA's eight hundred heavy lifeguard comin' out delta alpha with tango.
2008: 19 GND	ah TWA eight hundred heavy ah you're a life guard today?
2008: 24 RDO- 2	yes sir.

<u>INTRA- COCKPIT COMMUNICATION</u>		<u>AIR- GROUND COMMUNICATION</u>	
<u>TIME and SOURCE</u>	<u>CONTENT</u>	<u>TIME and SOURCE</u>	<u>CONTENT</u>
		2008: 25 GND	you know every day you come out and we don't know that you're a lifeguard and then you tell us you are and ah if you could tell company to ah you know ah put that in their flight plan ah it would help us out alot.
		2008: 38 RDO- 2	TWA's eight hundred understand I don't think they knew it either until the last minute.
		2008: 41 GND	all right TWA eight hundred taxi right on alpha and hold short of echo.
		2008: 47 RDO- 2	TWA's eight hundred right alpha hold short of echo.
		2008: 49 RDO- 3	and a load TWA eight hundred.
2008: 52 CAM- 1	right on alpha and hold short of echo.		
2008: 53 CAM- 1	clear right?		
2008: 54 CAM- 2	clear right.		

INTRA- COCKPIT COMMUNICATION

AIR- GROUND COMMUNICATION

<u>TIME and SOURCE</u>	<u>CONTENT</u>
2008: 55 CAM	((sound of parking break being released)).
2008: 57 CAM- 2	clear left.
2009: 19 CAM- 2	watch number one it's too high.
2009: 26 CAM- 1	forty five percent.
2009: 28 CAM- 1	you got a guy over there.
2009: 30 CAM- 2	yup.
2009: 34 CAM- 1	right on alpha huh?

<u>TIME and SOURCE</u>	<u>CONTENT</u>
2009: 05 RDO- 3	and load TWA eight hundred.
2009: 07 LOAD	eight hundred stand by.
2009: 36 LOAD	eight hundred ready to copy?

INTRA- COCKPIT COMMUNICATION

<u>TIME and SOURCE</u>	<u>CONTENT</u>
2009: 41 CAM- 1	clear.
2009: 42 CAM- 2	yeah.
2009: 43 CAM- 2	keep it comin'.
2009: 51 CAM- 1	does he look clear?
2009: 52 CAM- 2	yup it's no problem.

CONTENT

AIR- GROUND COMMUNICATION

<u>TIME and SOURCE</u>	<u>CONTENT</u>
2009: 37 RDO- 3	ready to copy.
2009: 38 LOAD	on board twenty nine up front one eight three in the rear takeoff fuel is one seven six decimal six your gross takeoff weight is five nine zero seven seven one trim six decimal one and no reported GSI's. copy?
2009: 56 RDO- 3	okay twenty nine in the front one eighty three in the back one seven six decimal six on the fuel five nine zero decimal seven seven one on the takeoff weight six point one on the trim and no GSIs TWA eight hundred out.

INTRA- COCKPIT COMMUNICATION

AIR- GROUND COMMUNICATION

<u>TIME and SOURCE</u>	<u>CONTENT</u>
2010: 01 CAM- 1	one two three --.
2010: 09 CAM- 1	ya think he's gunna try and get us out being a lifeguard?
2010: 15 CAM- 2	I think he just *.
2010: 19 CAM- 2	that's your undershoot problem huh.
2010: 21 CAM- 1	* it is ?

<u>TIME and SOURCE</u>	<u>CONTENT</u>
2010: 10 LOAD	okay read back. * both times?
2010: 12 RDO- 3	yeah we're out at ah zero zero zero two and ah expecting off here probably about ah thirty five.
2010: 24 LOAD	copy zero two and three five have a good flight eight hundred.
2010: 25 RDO- 3	see ya.

<u>INTRA- COCKPIT COMMUNICATION</u>	
<u>TIME and SOURCE</u>	<u>CONTENT</u>
2010: 26 CAM- 1	how's that look?
2010: 27 CAM- 2	better.
2010: 50 CAM- 3	six point one on the trim.
2010: 53 CAM- 2	okay set up here.
2011: 58 CAM- 1	well we lost a little bit of weight huh? payload.
2012: 24 CAM- 1	left on echo behind carnival hold short of three one right.
2012: 35 CAM- 2	((sound of cough)).

<u>AIR- GROUND COMMUNICATION</u>	
<u>TIME and SOURCE</u>	<u>CONTENT</u>
2012: 04 GND	TWA eight hundred make a left turn on um taxi way echo behind Carnival and hold short of runway three one right and you can monitor tower now on one two three point niner.
2012: 17 RDO- 2	TWA's eight hundred heavy left echo hold short of three one right over to the tower, bye.

<u>INTRA- COCKPIT COMMUNICATION</u>	
<u>TIME and SOURCE</u>	<u>CONTENT</u>
2012: 38 CAM	((sound of parking brake release)).
2012: 41 CAM- 2	can I have the weight slip if you are done with it, Ollie?
2013: 22 CAM- 2	notice that's going to be an undershoot too.
2013: 24 CAM- 1	what's that?
2013: 25 CAM- 2	good.
2013: 27 CAM- 1	well then someone's given me the wrong poop cause I was tryin' to turn like on the L ten eleven they said I was over- turning.
2013: 33 CAM- 2	ah.
2013: 38 CAM- 1	how much past center then?
2013: 40 CAM- 2	nose wheel is back by the emergency exit door. right?

AIR- GROUND COMMUNICATION

TIME and SOURCE

CONTENT

<u>INTRA- COCKPIT COMMUNICATION</u>		<u>AIR- GROUND COMMUNICATION</u>	
<u>TIME and SOURCE</u>	<u>CONTENT</u>	<u>TIME and SOURCE</u>	<u>CONTENT</u>
		2013: 41 TWR	and lifeguard TWA eight hundred heavy Kennedy tower good evening you with me?
2013: 42 CAM- 1	right, right.		
2013: 45 CAM-?	(sound of cough).		
2013: 46 CAM- 2	so you really can't start the turn until the nose wheel is past there the center taxi line and whatever it takes as far as -.		
2013: 54 CAM- 1	the angle but *.		
2013: 56 CAM- 2	as far as comin' out with the main gear you just want to play with it a little bit a few times to find out.		
2014: 04 CAM- 1	okay.		
2014: 07 CAM- 2	but that first turn would have been a very dirty *.		
2014: 10 CAM- 1	*.		

<u>INTRA- COCKPIT COMMUNICATION</u>		<u>AIR- GROUND COMMUNICATION</u>	
<u>TIME and SOURCE</u>	<u>CONTENT</u>	<u>TIME and SOURCE</u>	<u>CONTENT</u>
2014: 11 CAM- 2	there's no way you could - .		
		2014: 12 TWR	TWA eight hundred heavy lifeguard Kennedy tower.
		2014: 13 RDO- 2	TWA's eight hundred heavy lifeguard go ahead.
		2014: 16 TWR	I'm gunna put you behind British Airways so the company heavy seven six knows to follow you so make a right on the runway a left at Zulu alpha and follow British.
		2014: 23 RDO- 2	TWA eight hundred heavy okay right on ah thirty one ah correction thirteen left and follow British.
2014: 29 CAM- 1	start the number three motor.		
2014: 31 CAM- 2	let's.		
2014: 33 CAM- 2	start taxi.		

INTRA- COCKPIT COMMUNICATION

AIR- GROUND COMMUNICATION

<u>TIME and SOURCE</u>	<u>CONTENT</u>
2014: 36 CAM- 1	okay.
2014: 37 CAM- 2	are you ready?
2014: 37 CAM- 3	okay.
2014: 43 CAM- 2	just let me have one engine.
2014: 39 CAM- 3	there you go.
2014: 40 CAM-?	if you need it.
2014: 41 CAM- 3	all right we got enough pressure.
2014: 42 CAM- 2	okay here we go I'll get the engine for ya.
2014: 53 CAM- 2	watch your feet just steer it.
2014: 56 CAM- 2	just leave 'em alone for a little bit.

INTRA- COCKPIT COMMUNICATION

AIR- GROUND COMMUNICATION

<u>TIME and SOURCE</u>	<u>CONTENT</u>
2014: 58 CAM- 1	you want number three back?
2014: 59 CAM- 2	yup.
2015: 01 CAM- 2	don't touch the engines.
2015: 02 CAM- 1	okay.
2015: 04 CAM- 2	start lever.
2015: 08 CAM- 3	four hundred.
2015: 23 CAM- 2	okay you can have 'em now.
2015: 29 CAM- 2	here you got no problems.
2015: 33 CAM- 1	delayed engine -.

INTRA- COCKPIT COMMUNICATION

<u>TIME and SOURCE</u>	<u>CONTENT</u>
2015: 34 CAM- 2	wide runway you don't need to worry about it.
2015: 36 CAM- 1	yeah delayed engine start.
2015: 39 CAM- 3	delayed engine start checklist. start switches?
2015: 42 CAM- 1	off.
2015: 43 CAM- 3	start levers?
2015: 45 CAM- 1	idle detent.
2015: 47 CAM- 3	engine anti- ice?
2015: 47 CAM- 1	off.
2015: 51 CAM- 3	delayed engine start checklist is complete.
2015: 53 CAM- 1	taxi checklist.

AIR- GROUND COMMUNICATION

<u>TIME and SOURCE</u>	<u>CONTENT</u>
-------------------------------	-----------------------

INTRA- COCKPIT COMMUNICATION

AIR- GROUND COMMUNICATION

<u>TIME and SOURCE</u>	<u>CONTENT</u>	<u>TIME and SOURCE</u>	<u>CONTENT</u>
2015: 55 CAM- 3	taxi checklist. Flaps and runway?		
2015: 58 CAM- 1	flaps are ten and green for runway two two right Kennedy.		
2016: 04 CAM- 3	ten eight green two two right Kennedy. take off data EPR and airspeed bugs?		
2016: 08 CAM- 1	five hundred and ninety thousand seven seventy one takeoff EPR's set at point three three bugs set and cross checked at one fifty three.		
2016: 16 CAM- 2	set and cross checked.		
2016: 17 CAM- 3	stabilizer trim?		
2016: 18 CAM- 1	is set at six point one.		
2016: 21 CAM- 3	probe heat?		

INTRA- COCKPIT COMMUNICATION

<u>TIME and SOURCE</u>	<u>CONTENT</u>
2016: 22 CAM- 1	on.
2016: 23 CAM- 3	flight controls
2016: 25 CAM- 1	checked.
2016: 26 CAM- 3	auto- brakes?
2016: 28 CAM- 1	armed.
2016: 29 CAM- 2	now you can start it.
2016: 31 CAM- 3	yaw dampers?
2016: 32 CAM- 1	on.
2016: 34 CAM- 2	wrong answer checked.
2016: 35 CAM- 1	checked.

AIR- GROUND COMMUNICATION

<u>TIME and SOURCE</u>	<u>CONTENT</u>
-------------------------------	-----------------------

<u>INTRA- COCKPIT COMMUNICATION</u>	
<u>TIME and SOURCE</u>	<u>CONTENT</u>
2016: 37 CAM- 2	right here don't roll out start rollin' out you're beside the line.01
2016: 43 CAM- 3	seat belt shoulder harnesses?
2016: 44 CAM- 1	checked.
2016: 51 CAM- 1	okay gentlemen standard TWA crew coordination you call out eighty Vee one Vee R please.
2016: 58 CAM- 2	that's the first officers -.
2017: 00 CAM- 1	we're going to fly headings, huh.
2017: 02 CAM- 2	I say that's standard first officer duties.
2017: 06 CAM- 1	well.
2017: 07 CAM- 3	taxi checklist is complete.

<u>AIR- GROUND COMMUNICATION</u>	
<u>TIME and SOURCE</u>	<u>CONTENT</u>

<u>INTRA- COCKPIT COMMUNICATION</u>	
<u>TIME and SOURCE</u>	<u>CONTENT</u>
2017: 08 CAM- 1	two hundred five degree on the heading five thousand.
2017: 10 CAM- 2	that's it.
2017: 18	
2017: 28 CAM- 1	position and hold two two right.
2017: 31 CAM- 1	will you alert the cabin please.
2017: 40 CAM- 3	flight attendants please be seated for takeoff.
2017: 55 CAM- 4	****.
2018: 03 CAM- 2	now that's better.

<u>AIR- GROUND COMMUNICATION</u>	
<u>TIME and SOURCE</u>	<u>CONTENT</u>
TWR	TWA eight hundred heavy caution wake turbulence from a seven fifty seven runway two two right taxi into position and hold.
2017: 24 RDO- 2	TWA's eight hundred heavy lifeguard position and hold two two right.

INTRA- COCKPIT COMMUNICATIONAIR- GROUND COMMUNICATION

<u>TIME and SOURCE</u>	<u>CONTENT</u>	<u>TIME and SOURCE</u>	<u>CONTENT</u>
2018: 04 CAM- 3	now it's coming on *.		
2018: 06 CAM- 1	I'll just extend it out to that line.		
2018: 07 CAM- 3	* sure *.		
2018: 09 CAM- 2	yeah that's one of the ways you test yourself too is whether when you get rolled out is the whole airplane longitudinally lined up.		
2018: 15 CAM- 1	yeah.		
		2018: 21 TWR	TWA eight hundred heavy lifeguard wind's two four zero at eigh runway two two right cleared for takeoff.
		2018: 27 RDO- 2	TWA's eight hundred heavy lifeguard cleared for takeoff two two right.
2018: 31 CAM- 1	before takeoff checklist.		
2018: 33 CAM- 3	before takeoff checklist. icing considerations?		

INTRA- COCKPIT COMMUNICATION

<u>TIME and SOURCE</u>	<u>CONTENT</u>
2018: 34 CAM- 1	checked.
2018: 35 CAM- 3	cabin alert?
2018: 36 CAM- 1	checked.
2018: 36 CAM- 3	transponder?
2018: 37 CAM- 1	that's checked.
2018: 39 CAM- 3	ignition?
2018: 40 CAM	((sound of click)).
2018: 41 CAM- 1	flight start.
2018: 42 CAM- 3	body gear steering?

AIR- GROUND COMMUNICATION

<u>TIME and SOURCE</u>	<u>CONTENT</u>
-------------------------------	-----------------------

<u>INTRA- COCKPIT COMMUNICATION</u>	
<u>TIME and SOURCE</u>	<u>CONTENT</u>
2018: 43 CAM- 1	disarmed.
2018: 44 CAM- 2	clocks.
2018: 46 CAM- 3	before takeoff checklist is complete.
2018: 48 CAM- 1	thank you.
2018: 49 CAM- 4	get right up in there.
2018: 51 CAM	((sound of increasing engine noise)).
2018: 59 CAM- 1	trim throttles.
2019: 14 CAM- 2	eighty knots.
2019: 23 CAM- 2	Vee one.
2019: 35 CAM- 2	Vee R.

<u>AIR- GROUND COMMUNICATION</u>	
<u>TIME and SOURCE</u>	<u>CONTENT</u>

<u>INTRA- COCKPIT COMMUNICATION</u>		<u>AIR- GROUND COMMUNICATION</u>	
<u>TIME and SOURCE</u>	<u>CONTENT</u>	<u>TIME and SOURCE</u>	<u>CONTENT</u>
2019: 41 CAM	((sound of two clicks)).		
2019: 43 CAM- 1	gear up.		
2019: 44 CAM- 2	gear up.		
		2020: 00 TWR	TWA eight hundred heavy contact New York departure one three five point niner good evening.
		2020: 05 RDO- 2	TWA's eight hundred heavy good night.
		2020: 14 RDO- 2	Kennedy departure TWA's eight hundred heavy lifeguard leaving nine hundred climbing five thousand.
		2020: 19 DEP	lifeguard TWA eight hundred heavy New York departure radar contact climb and maintain one one thousand.
		2020: 24 RDO- 2	TWA's eight hundred heavy climb and maintain one one thousand.

INTRA- COCKPIT COMMUNICATION

<u>TIME and SOURCE</u>	<u>CONTENT</u>
2020: 29 CAM- 1	climb to one one thousand and maintain.
2020: 47 CAM- 1	left to one five zero.
2020: 51 CAM- 1	flaps five.
2020: 53 CAM- 2	flaps five.
2021: 11 CAM- 1	flaps one.
2021: 12 CAM- 2	flaps one.
2021: 26 CAM- 1	flaps up.
2021: 29 CAM- 2	say what?

AIR- GROUND COMMUNICATION

<u>TIME and SOURCE</u>	<u>CONTENT</u>
2020: 44 DEP	TWA eight hundred heavy turn left heading one five zero.
2020: 48 RDO- 2	TWA's eight hundred heavy turn left heading one five zero.

INTRA- COCKPIT COMMUNICATION

<u>TIME and SOURCE</u>	<u>CONTENT</u>
2021: 29 CAM- 1	flaps up.
2021: 30 CAM- 2	flaps up.
2021: 48 CAM- 1	climb thrust.

2022: 11 CAM- 1	left zero seven zero.
--------------------	-----------------------

AIR- GROUND COMMUNICATION

<u>TIME and SOURCE</u>	<u>CONTENT</u>
2022: 01 DEP	TWA lifeguard TWA eight hundred heavy turn left heading zero seven zero.
2022: 07 RDO- 2	TWA's lifeguard eight hundred heavy turn left heading zero seven zero.
2022: 29 DEP	TWA eight hundred heavy or lifeguard TWA eight hundred heavy turn left heading zero five zero vector climbin' around traffic.
2022: 35 RDO- 2	TWA's eight hundred heavy turn left heading zero five zero.

<u>INTRA- COCKPIT COMMUNICATION</u>	
<u>TIME and SOURCE</u>	<u>CONTENT</u>
2022: 41 CAM- 1	left zero five zero climb vector.
2022: 58 CAM- 1	he's at three o'clock?
2023: 00 CAM- 2	yeah.
2023: 02 CAM- 2	that's the problem.
2023: 26 CAM- 1	direct Betty and our own nav.

<u>AIR- GROUND COMMUNICATION</u>	
<u>TIME and SOURCE</u>	<u>CONTENT</u>
2022: 44 DEP	TWA eight hundred heavy the traffic in the turn will be three o'clock and five miles northeast bound four thousand nor- is a company seven two five five in trail will be a Saab-Fairchild when you're out of five I'll have on course.
2022: 54 RDO- 2	TWA's eight hundred heavy understand.
2023: 19 DEP	TWA eight hundred heavy direct Betty resume own navigation.
2023: 22 RDO- 2	TWA's eight hundred heavy direct Betty own navigation.

<u>INTRA- COCKPIT COMMUNICATION</u>		<u>AIR- GROUND COMMUNICATION</u>	
<u>TIME and SOURCE</u>	<u>CONTENT</u>	<u>TIME and SOURCE</u>	<u>CONTENT</u>
2019: 52 CAM- 1	that's alive.		
		2023: 37 DEP	TWA lifeguard TWA eight hundred heavy contact Boston one three two point three.
2023: 38 CAM- 2	huh.		
2023: 39 CAM- 1	direct Betty. correct?		
		2023: 42 RDO- 2	TWA's eight hundred heavy ah say again the frequency.
		2023: 44 DEP	one three two point three.
		2023: 46 RDO- 2	TWA's eight hundred heavy good day.
2024: 00 CAM- 1	*		
2024: 01 CAM	((sound of noise of recording tape)).		

INTRA- COCKPIT COMMUNICATION

<u>TIME and SOURCE</u>	<u>CONTENT</u>
2024: 30 CAM- 1	seems like a home sick angel here (*/ awesome).
2024: 36 CAM- 2	it's bleeding off airspeed that's why.
2024: 38 CAM- 1	yeah *.

AIR- GROUND COMMUNICATION

<u>TIME and SOURCE</u>	<u>CONTENT</u>
2024: 41.7 RDO- 2	New York center TWA's lifeguard eight hundred heavy eight thousand two hundred climbing one one thousand.
2024: 48 CTR	TWA eight hundred Boston center roger climb and maintain one three thousand.
2024: 53.4 RDO- 2	TWA's eight hundred heavy climb and maintain one three thousand.
2024: 57 CAM- 1	climb and maintain one three thousand.
2025: 31 CTR	TWA eight hundred what's your rate of climb?
2025: 34.5 RDO- 2	TWA's eight hundred heavy ah about two thousand feet a minute here until accelerating out of ten thousand.

<u>INTRA- COCKPIT COMMUNICATION</u>		<u>AIR- GROUND COMMUNICATION</u>	
<u>TIME and SOURCE</u>	<u>CONTENT</u>	<u>TIME and SOURCE</u>	<u>CONTENT</u>
		2025: 41 CTR	roger sir climb and maintain flight level one niner zero and expedite through fifteen.
		2025: 47.1 RDO- 2	TWA's eight hundred heavy climb and maintain one niner zero and expedite through one five thousand.
2025: 53 CAM- 1	climb to one nine zero expedite through one five thousand.		
2025: 57 CAM- 3	pressurization checks.		
2025: 59 CAM- 3	(takeoff) thrust go on cross feed?		
2026: 02 CAM-?	ah.		
2026: 04 CAM- 1	yeah.		
2026: 07 CAM- 3	I'll leave that on for just a little bit.		
2026: 12 CAM- 3	is that right?		

<u>INTRA- COCKPIT COMMUNICATION</u>		<u>AIR- GROUND COMMUNICATION</u>	
<u>TIME and SOURCE</u>	<u>CONTENT</u>	<u>TIME and SOURCE</u>	<u>CONTENT</u>
2026: 13 CAM- 4	yes.		
		2026: 24 CTR	TWA eight hundred amend the altitude maintain ah one three thousand thirteen thousand only for now.
2026: 29 CAM- 1	thirteen thousand.		
		2026: 30.3 RDO- 2	TWA's eight hundred heavy okay stop climb at one three thousand.
2026: 35 CAM- 1	stop climb at one three thousand.		
2026: 51 CAM- 1	*.		
2026: 59 CAM- 2	twelve for thirteen.		
2027: 35 CAM	((sound of click)).		
2027: 47 CAM	((sound of altitude alert tone)).		

INTRA- COCKPIT COMMUNICATIONAIR- GROUND COMMUNICATIONTIME and
SOURCECONTENTTIME and
SOURCECONTENT

2028: 13
CTR

TWA eight hundred you have traffic at one o'clock and
ah seven miles south bound a thousand foot above you he's
ah Beech nineteen hundred.

2028: 20.6
RDO- 2

TWA's ah eight hundred heavy ah no contact.

2028: 22.5
RDO- 3

FIC TWA eight hundred.

2028: 25
FIC

TWA eight hundred.

2028: 25.7
RDO- 3

Eight hundred with an off report ah plane number one seven
one one nine we're out at zero zero zero two, and we're off at
zero zero one nine, fuel one seven nine decimal zero,
estimating Charles De' Gaul at zero six two eight.

2028: 42
FIC

TWA eight eight hundred got it all.

2028: 44.8
RDO- 3

Thank you.

2029: 15

CAM- 1 look at that crazy fuel flow indicator there on number four.

<u>INTRA- COCKPIT COMMUNICATION</u>		<u>AIR- GROUND COMMUNICATION</u>	
<u>TIME and SOURCE</u>	<u>CONTENT</u>	<u>TIME and SOURCE</u>	<u>CONTENT</u>
2029: 23 CAM- 1	see that.		
2029: 35 CAM- 1	some where in here I better trim this thing (in/up).		
2029: 39 CAM- 2	huh?		
2029: 39 CAM- 1	some place in here I better find out where this thing's trimmed.		
		2030: 15 CTR	TWA eight hundred climb and maintain one five thousand.
2030: 18 CAM- 1	climb thrust.		
		2030: 19.2 RDO- 2	TWA's eight hundred heavy climb and maintain one five thousand leaving one three thousand.
2030: 24 CAM- 1	Ollie.		
2030: 24 CAM- 3	huh.		

INTRA- COCKPIT COMMUNICATION

AIR- GROUND COMMUNICATION

<u>TIME and SOURCE</u>	<u>CONTENT</u>
2030: 25 CAM- 1	climb thrust.
2030: 28 CAM- 1	climb to one five thousand.
2030: 35 CAM- 3	power's set.
2030: 42 CAM	((sound similar to a mechanical movement in cockpit))
2031: 03 CAM	*.
2031: 05 CAM	((sounds similar to recording tape damage noise)).
2031: 12	end of recording.

Appendix C

Search and Recovery Information

Search and Recovery

Agencies and companies with personnel and equipment that responded promptly to the accident and reported to the crash site and/or staging areas and/or provided long-term assistance during the search and recovery operation included most of the parties to the investigation and the following: Federal Bureau of Investigation (FBI);⁶⁶² Bureau of Alcohol, Tobacco, and Firearms; U.S. Coast Guard (USCG) (including its Underwater Search and Survey Divisions); U.S. Navy (and its contractor, Oceaneering Advanced Technologies, Inc., and subcontractor, Science Applications International Corporation); New York Air National Guard; New York State Army National Guard, 106th Air Rescue Wing; National Oceanic and Atmospheric Administration (NOAA); New York State Emergency Management Office; New York State Division of State Police; New York City Police and Fire Departments; Suffolk County Police and Sheriff's Departments, Medical Examiner, and Fire, Rescue, and Emergency Services; Nassau County Police Department; Southampton Police Department; East Moriches Fire Department; and American Underwater Search and Survey Ltd.

During the first several hours after the accident, many private citizens and military and police personnel went to the crash site in boats to search for possible survivors.⁶⁶³ The first responders reported that many pieces of wreckage (some quite large, including the right wing tip) were found floating in or near areas of fuel-fed fires, making recovery difficult. Although many first responders reported that they observed numerous pieces of wreckage sink beneath the water's surface, several pieces of wreckage were recovered from the water's surface during the 24-hour period after the accident.⁶⁶⁴

Because the Moriches Inlet was the closest inlet to the accident site (about 8 miles), throughout the night of July 17, boats traveled from the accident site to the USCG station at East Moriches, New York, with human remains and airplane debris. This station became the hub for staging and coordinating the search and recovery efforts almost immediately after the accident occurred. On July 18, 1996, the Safety Board, with other involved agencies, established a biohazard containment procedure for the search and recovery operation. The Suffolk County Medical Examiner established a temporary

⁶⁶² Because of the possibility that the TWA flight 800 accident was the result of a terrorist or criminal act, the FBI was involved in the investigation from July 17, 1996, until November 18, 1997, at which time, it determined that a terrorist or criminal act most likely did not cause the accident and withdrew from active involvement in the investigation.

⁶⁶³ For additional information regarding the survival aspects of this accident, see section 1.15.

⁶⁶⁴ The first responders' attempts to recover wreckage were limited by the presence of fuel-fed fires, the equipment available, and the size of some pieces of wreckage. For example, the crew of the USCG vessel *Juniper*, a 225-foot cutter/buoy tender, tried to recover the right wing tip, but the crane on board the boat was too short.

morgue at the East Moriches location.⁶⁶⁵ A staging area for the ship-shore-hangar transfer of recovered airplane wreckage and debris was established at the USCG station at Shinnecock Inlet, New York (about 18 miles northeast of the debris fields).⁶⁶⁶ Figures 21 and 22 in section 1.12 show the accident airplane's approximate flightpath, the Moriches and Shinnecock Inlets, and the three major identified debris fields.

On July 18, 1996, the Safety Board requested the U.S. Navy's assistance in the underwater search and recovery of the victims, the flight data recorder (FDR) and cockpit voice recorder (CVR), and the airplane wreckage.⁶⁶⁷ Also on July 18, teams of scuba divers from state and local police departments began operations to recover victims and debris. SUPSALV coordinated with the NOAA vessel *Rude* (which arrived on scene on the night of the accident)⁶⁶⁸ to use its side-scan sonar (SSS) to locate victims and wreckage on the ocean floor and to help target scuba divers' efforts until additional U.S. Navy personnel and equipment arrived. SUPSALV also contracted for the services of the commercial vessel *Pirouette*, which arrived on scene on the evening of July 19, 1996. On July 20, 1996, the *Pirouette* (supplied with U.S. Navy-owned equipment, including an SSS system, a towed-pinger locator, and a mini-remote operated vehicle [ROV]) joined the *Rude* in its efforts to locate victims and the FDR and CVR (which, as previously indicated, were recovered on July 24) and to map the underwater debris fields.

On July 21, the U.S. Navy's Explosive Ordnance Disposal and mobile diving units of the Atlantic Fleet arrived, providing additional scuba divers, surface support personnel, and the equipment and logistical support necessary for establishing a fully operational shore-based command, communication, and control center and dive station at the East Moriches location. The shore-based scuba diving operation used small watercraft to transport scuba divers from the U.S. Navy and local police departments between the shore-based dive station and the dive locations. Because this process was recognized as cumbersome and time-consuming (in part because of the distances involved), ocean-based diving stations were established when the necessary support equipment arrived at the site about a week after the accident.

⁶⁶⁵ A more permanent morgue operation was subsequently established at the Suffolk County Medical Examiner's Office in Hauppauge, New York.

⁶⁶⁶ The Shinnecock Inlet location was chosen for transfer of recovered airplane wreckage and debris instead of the Moriches Inlet because the Shinnecock Inlet is wider and, thus, has significantly calmer water, facilitating the passage of boats loaded with wreckage.

⁶⁶⁷ The Safety Board has had a memorandum of understanding with the U.S. Navy regarding wreckage recovery for many years and has requested the U.S. Navy's assistance during several investigations, including the United Airlines flight 811 accident on February 24, 1989, involving the in-flight separation of a cargo door on a Boeing 747-122 near Honolulu, Hawaii. Additionally, the U.S. Navy was involved in the search and recovery efforts for the Air India Airlines 747 that crashed in the Atlantic Ocean off the coast of Ireland in June 1985; the space shuttle Challenger in 1986; the South African Airways flight 295 747-200B airplane that crashed 130 miles northeast of Mauritius in November 1987; and the Birgenair 757 that crashed off the coast of the Dominican Republic in February 1996. U.S. Navy Supervisor of Salvage and Diving's (SUPSALV) testimony during the Board's December 1997 TWA flight 800 public hearing indicated that, on average, the U.S. Navy recovers about one military airplane from the ocean every 3 weeks.

⁶⁶⁸ The *Rude* is an oceangoing research vessel that responded from Newport, Rhode Island, on the night of the accident to assist in the search for possible survivors and the early recovery efforts. The *Rude* continued to assist in search and recovery efforts until it departed the area on August 1, 1996.

By the end of July, two U.S. Navy salvage ships (the U.S.S. *Grasp* and U.S.S. *Grapple*) had reported to the accident site and were providing ocean-based stations for surface-supplied scuba diving and ROV operations. The U.S.S. *Grasp* was moored over the major area of airplane debris in the green zone, and the U.S.S. *Grapple* was moored over the major area of airplane debris in the yellow zone.⁶⁶⁹ These ships were equipped with high-capacity cranes for lifting large pieces of debris from the water. Two U.S. Navy support vessels, the U.S.S. *Oak Hill* and U.S.S. *Trenton*, provided logistical support (berthing, dining, and medical) for scuba divers operating from the U.S.S. *Grapple* and U.S.S. *Grasp*, as well as a landing/docking area for the helicopters and amphibious watercraft engaged in the transportation of debris, personnel, and supplies. (Figure 47 shows a time line of salvage operation events, excerpted from the U.S. Navy's report.)⁶⁷⁰

Throughout most of the search and recovery operation, ROV, SSS, and laser line-scanning (LLS) equipment were used to search existing debris fields. This equipment was also used to explore areas outside existing debris fields that might contain victims and wreckage and to videotape the wreckage and ocean floor. Scuba divers and ROVs were used to systematically recover victims and wreckage.

Recovery Procedures

Small pieces of wreckage and debris were placed in bags and carried to the ocean surface by divers or placed in salvage baskets and lifted to the ocean surface by an amphibious tugboat or a salvage ship. (The ROVs performed some limited recovery tasks. The larger ROV could grip larger objects and perform some rigging tasks with its two sophisticated manipulator arms; however, the mini-ROVs could only retrieve small objects with their simple manipulators.) Larger items were rigged with lifting straps by divers and lifted by the tugboat (or, in the case of two very large pieces, the ship). Although some particularly small and/or potentially important pieces of wreckage were transported to shore by helicopter, most of the wreckage was transported to shore on the amphibious tugboats. Some very large pieces (including an 80-foot-long section of the right wing) had to be cut into smaller sections before they could fit on the amphibious tugs for the move to shore and in the trucks for the move to a storage/reconstruction facility. (The Safety Board leased a hangar at the former Grumman Aircraft facility in Calverton, New York, to be used for wreckage storage, examination, and reconstruction; this facility became the command center and headquarters for the investigation.)

⁶⁶⁹ All other scuba diving (red zone and other areas of debris) was accomplished by mobile scuba diving teams operating from small boats.

⁶⁷⁰ U.S. Navy. 1998. *U.S. Navy Salvage Report TWA Flight 800*. Report S0300-BZ-RPT-010, 0910-LP-015-6130.

FLIGHT 800 SALVAGE OPERATIONS TIME LINE OF EVENTS

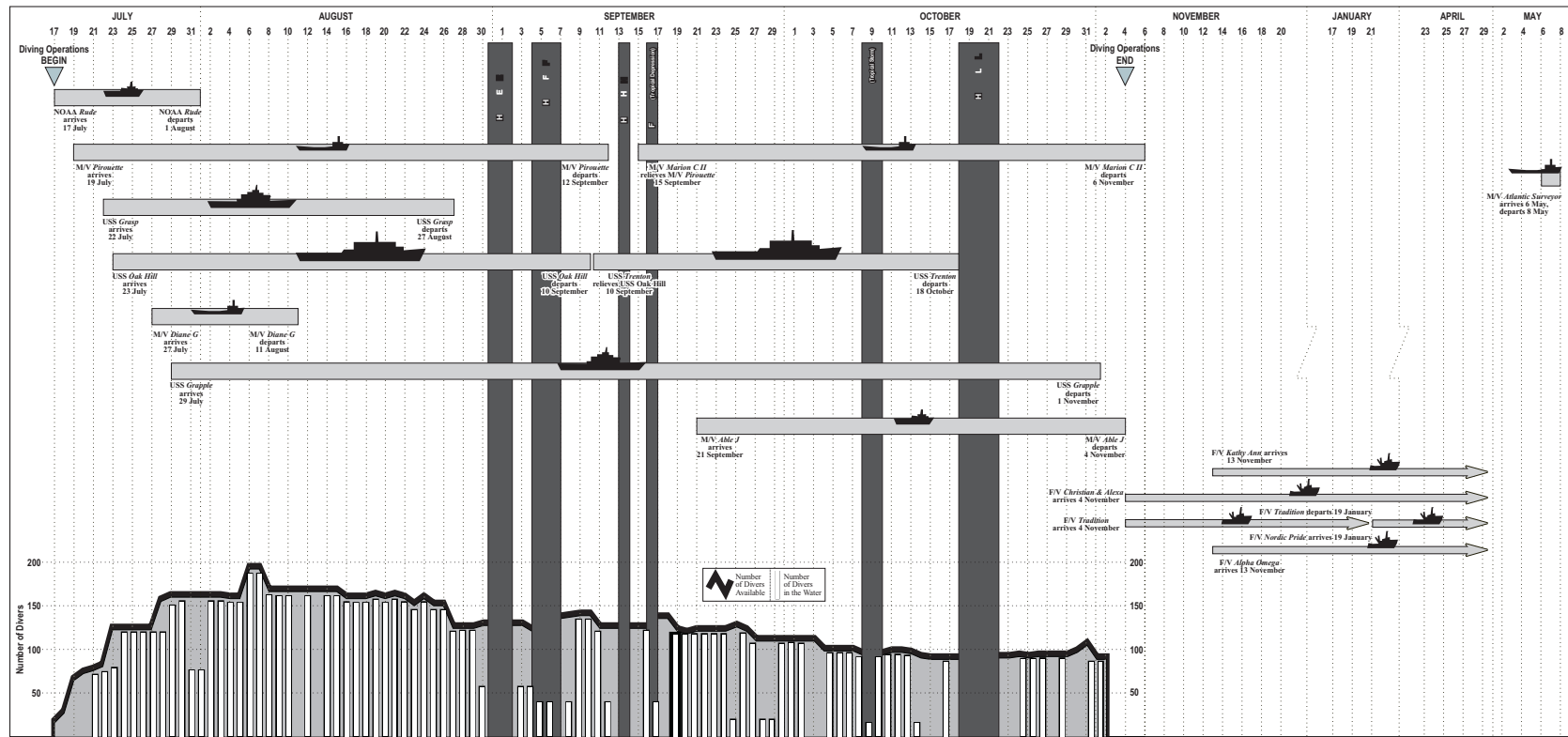

Figure 47. A time line of salvage operation events.

When the amphibious tugboats arrived at Shinnecock Inlet with wreckage, New York State Army National Guard and/or local police personnel used a mobile crane to transfer wreckage from the tugboats to 18-wheeled open bed trucks, which then transported the wreckage to the hangar at Calverton.⁶⁷¹ Safety Board and FBI personnel were present to observe all wreckage transfers to preserve the evidentiary value of the wreckage. Also, to ensure that wreckage recovery locations were accurately tracked, the amphibious tugboats and trucks/trailers were searched for any dropped debris after each trip.

U.S. Navy Salvage Report Information

The U.S. Navy's report, which documented the TWA flight 800 search and recovery efforts, indicated that the search and recovery operation occurred in the following three phases: (1) a period of intense activity, from July 17 to the end of August 1996; (2) a period of sustained effort, from September 1 to November 2, 1996; and (3) trawling operations, from November 4, 1996, to April 28, 1997.

According to the U.S. Navy report, the period of intense activity primarily involved recovering victims and those pieces of the airplane seen as critical to the investigation. These efforts included a thorough mapping of the debris on the ocean floor and required the almost continual use of ROVs, SSS, LLS equipment, and scuba divers. During the month of August, an average of 153 divers were available; on 26 days in August, all available divers were used. By the end of August, 211 victims had been recovered and identified. According to the U.S. Navy report, "two events marked the end of the period of intense activity and the beginning of the period of sustained effort. The first was the [August 27] departure...of the *Grasp* and the 25 divers that she carried. The second was the occurrence of heavy weather, much of it the result of Atlantic hurricanes, that made diving operations impossible on more than half of the days in September."⁶⁷²

The period of sustained effort involved the continued use of ROVs, SSS, LLS equipment, and scuba divers to recover the remaining victims and as much of the airplane as possible. In part because of inclement weather, the pace of the recovery operations moderated during this period. High swells and currents from Hurricane Edouard and other storms that affected the area during these months caused significant shifting of the wreckage and sand, requiring debris fields to be remapped. According to the U.S. Navy report, the period of sustained effort was "characterized by the steady and thorough exploitation of the debris fields. [SSS] was used to expand existing debris fields, make more detailed searches of existing debris fields, and explore areas that might contain debris. Divers and ROVs were used to systematically remove all of the debris from one

⁶⁷¹ The New York State Army National Guard provided 12 tractors and 10 trailers to transport wreckage to the hangar at Calverton.

⁶⁷² With the onset of autumn, severe weather became an increasingly significant operational factor in the search and recovery efforts. Five major storm systems affected the search and recovery operations in varying degrees: Hurricane Edouard (August 19 to September 3), Hurricane Fran (August 23 to September 8), Hurricane Hortense (September 3 to 16), Hurricane Josephine (October 4 to 8), and Hurricane Lili (October 14 to 27).

debris field before moving on to the next.” The last search and recovery-related SSS and scuba diving operations occurred on October 13 and November 2, respectively. By November 2, about 95 percent of the airplane wreckage had been recovered.

At the Safety Board’s request, the U.S. Navy proposed many options for the third phase of the recovery operation.⁶⁷³ After reviewing the options, the Board chose trawling for the third phase because it provided an optimal combination of expected effectiveness, cost, environmental impact, and suitability for winter operations. Trawling operations involved the use of five commercial trawlers, under contract to the U.S. Navy, to scrape up layers of silt to recover pieces of wreckage that had become embedded in the ocean floor. Trawl lines several miles long were carefully laid out to cover the entire area being trawled, criss-crossing the debris fields, and the Board monitored and prioritized the trawling areas carefully. The scallop trawlers then moved along the trawl lines at 2 to 3 knots, towing 15-foot-wide nets on each side of the ship. After the trawler completed each pass along a trawl line, the nets were brought aboard and emptied; all natural materials were discarded; and all man-made objects were retained, documented, and transported to shore on small boats. Successive trawler sweeps were made to cover the gap between the two nets, and each area was reswept until no new material was recovered (some lines in the red zone were swept more than 10 times). When material recovered by the trawlers reached shore, it was examined by Safety Board personnel, who separated the airplane debris from other objects.

The trawling operation was complicated by the presence of a submerged trans-Atlantic telephone cable inside the northern boundary of the trawling area. To avoid snagging or otherwise damaging the telephone cable, the commercial scallop trawlers did not trawl within 200 yards of the cable; however, the area within 200 yards of the cable was thoroughly inspected and documented by an AT&T ROV and was declared clear of airplane debris.

Trawling operations ended on April 28, 1997, because successive trawling sweeps turned up no additional debris. Between April 30 and May 18, 1997, a U.S. Navy ROV was used to make a final inspection of the wreckage recovery area. The ROV made 85 dives after the trawling operations ceased, locating only one small piece of additional wreckage; therefore (with the concurrence of the Safety Board and the FBI), trawling and other search and recovery efforts were formally terminated on May 18, 1997. The trawling operation recovered pieces of the airplane that amounted to about 1 to 2 percent of its structure.

⁶⁷³ Proposed options for the third phase of the recovery operation included trawling, the development of a rake attachment for ROVs, the use of a suction dredge, lift excavation, and the continued employment of scuba divers.

Appendix D

Document Management Tags Database Information

Pieces of wreckage were tagged with color-coded and numbered tags that corresponded to the debris field from which they were recovered. The color-coded tags were usually attached to items promptly upon recovery and before items were transported to the hangar; however, in some cases, items were not tagged until they arrived at the hangar.⁶⁷⁴ A data management team consisting of Safety Board investigators, party representatives, and representatives from the Navy and its contractor Oceaneering Advanced Technology, Inc.,⁶⁷⁵ compiled a database from wreckage logs completed when recovered items were tagged. Subsequently, the team cross-checked the information in this database against all available sources of recovery information, including diver logs, ship records, photographs, videotapes, target assignments, FBI evidence records, and identification of parts made by investigative team members, to ensure that the most valid information was contained in the tags database system.

Of the 3,168 recovered items that received color-coded identification tags on the ships, 645 items were recovered from the red zone, 462 items were recovered from the yellow zone, and 1,885 items were recovered from the green zone. In addition, 176 items were recovered from other locations (orange), were found floating (blue), or were recovered from unknown locations (white).⁶⁷⁶ Additionally, 1,444 recovered items arrived (or were discovered) at the hangar without tags. Of the 1,444 hangar tags, 1,210 were assigned to items recovered during the dive operation, and 234 were assigned to items recovered during the trawling operation.⁶⁷⁷ Untagged pieces were tagged, if necessary.

When each piece of wreckage arrived at the hangar in Calverton, it was examined by members of the Structures Group, who, when possible, identified the portion of the airplane from which the wreckage piece had originated. A log number was generated for

⁶⁷⁴ Although most pieces of wreckage were ship-tagged, during salvage and reconstruction efforts it occasionally became necessary to cut or separate objects (previously tagged as a whole) into more than one piece, leaving some untagged portions. Additionally, some objects were extracted from an entangled group of debris (recovered and tagged as a unit); in some cases, pieces were received in a bag, net, or box full of other items with one tag assigned to the container. Finally, some parts simply broke during handling/transport, leaving some parts untagged. In all of these situations, the recovery position information on the ship tag from the original object or group of objects was transferred to the hangar tag(s) assigned to the separated object(s). All large and small pieces of wreckage that were identifiable and considered significant were tagged.

⁶⁷⁵ Representatives from the Federal Bureau of Investigation (FBI) and the Structures and Airplane Interior Documentation Groups also participated in this effort at various times, as needed.

⁶⁷⁶ Some floating and/or washed ashore items received blue tags, and others received white tags.

⁶⁷⁷ Tags that were color coded to reflect the debris zones (red, yellow, or green) were assigned to trawled items based on the zone in which the item was recovered. Color-coded tags were also assigned to the remaining 1,210 items tagged in the hangar. Of these, 145 corresponded to the known recovery zone, and the remaining 1,065 were assigned color-coded tags based on the probable recovery zone, which was identified by cross-referencing the FBI lot number of the previously untagged item with the ship-tagged items in the same lot.

the pieces that could be structurally identified, and pieces were further examined, sketched, and photographed, as appropriate. Log numbers were written on the piece of wreckage and on a separate tag that was attached to the piece. Log number classifications subdivided the wreckage into 12 subgroups and used the following nomenclature (XX denotes the number assigned to an individual piece):

LF-XX	Left fuselage
RF-XX	Right fuselage
LW-XX	Left wing
RW-XX	Right wing
H-XX	Horizontal stabilizer (both sides)
LE-XX	Left elevator
RE-XX	Right elevator
V-XX	Vertical stabilizer
R-XX	Rudder
CW-1XX	Wing center section (WCS)—upper skin
CW-2XX	WCS—lower skin
CW-3XX	WCS—right side-of-body rib
CW-4XX	WCS—left side-of-body rib
CW-5XX	WCS—front spar
CW-6XX	WCS—spanwise beam (SWB) 3
CW-7XX	WCS—SWB2
CW-8XX	WCS—mid spar
CW-9XX	WCS—SWB1
CW-10XX	WCS—rear spar
CW-11XX	WCS—butt line zero rib
FBM-XX	Floor beam
LG-XX	Landing gear

This wreckage documentation was maintained in a massive database that was cross-referenced by investigative groups during the investigation. This database contained details related to each piece, such as recovery location, extent and type of damage, photographs, sketches, and Boeing's engineering drawings depicting the part's location on the airplane.

Migration of TWA Flight 800 Debris

During the first few days of recovery efforts, investigators used ocean current data to predict where pieces of wreckage would have come to rest on the ocean floor. After confirming wreckage locations through the use of side-scan sonar (SSS) equipment,

investigators and recovery crews were able to focus their recovery efforts productively. Pieces of wreckage important to the investigation (sequencing and trajectory efforts) were located and recovered during the first month after the accident in the positions initially identified by SSS equipment. However, as recovery efforts continued, it was necessary to expand the area searched by the SSS equipment, in part, because ocean currents resulted in the continual shifting of the sediment on the ocean floor and migration (and/or concealment) of pieces of wreckage.⁶⁷⁸

⁶⁷⁸ Although the positions of heavier pieces of wreckage would be less affected by ocean currents than those of lighter pieces, such items would be subject to concealment by shifting sediment on the ocean floor.

Appendix E

Accident Airplane Maintenance Records

The National Transportation Safety Board's review of the accident airplane's maintenance records revealed numerous fuel system-related maintenance writeups during the 2 years before the accident. The accident airplane's maintenance records described the following discrepancies, which occurred during refueling, and the resultant maintenance actions:

- Nonroutine Maintenance Record—December 16, 1995. The airplane would not accept fuel. The volumetric control was replaced, and the system operation checked normal.
- Nonroutine Maintenance Record—April 21, 1996. The airplane would not accept fuel. The four main fuel tanks were pressure-fueled. A followup check indicated that the system operated normally during ground fueling.
- Aircraft Maintenance Log—April 28, 1996. The airplane's wing refueling valves closed continuously for no apparent reason. The fueler was able to fuel by moving the fuel switch back and forth between the normal and battery positions. The connector at the fueling panel was cleaned, and the anomaly was listed on the Open Item Work Sheet to correct, as required.
- Aircraft Maintenance Log—April 30, 1996. The airplane's fueling system shut down, and the airplane would not accept fuel. The item was deferred until May 1, 1996, when the fueling panel magnet was replaced, and the system operation checked normal.
- Aircraft Maintenance Log—May 2, 1996. (This writeup references the April 30, 1996, logbook entry above.) The airplane's No. 4 main fuel gauge volumetric switch shut off at "22.4," and the volumetric switch in the main electrical service bay shut off all the fueling valves at the under-wing fueling station. The item was deferred until May 5, 1996, when the R118 ground handling No. 2 relay was replaced because there was "no power at B2 terminal, and only 19 vdc [volts direct current] on the external power output." The system operation checked normal.
- Nonroutine Maintenance Record—May 15, 1996. The fuse and fuse holder were missing from the volumetric controller. Both fuses were replaced.
- Nonroutine Maintenance Record—May 23, 1996. The airplane would not accept fuel. The fueling panel magnet was replaced, the panel was secured, and the system operation checked normal.
- Nonroutine Maintenance Record—June 4, 1996. The airplane's fueling system shut down while fueling. The volumetric switch and valves were cycled several times, and the system subsequently checked normal. When the

auto-fuel shut off about 80,000 to 85,000 pounds, the overflow circuit breaker was pulled to continue fueling. Maintenance personnel suspected that the No. 1 reserve or main refuel valve was not shutting completely.

- Aircraft Maintenance Log—July 7, 1996. All fuel valves shut off during fueling and did not open electrically. The surge tank was sumped; all of the valves then operated normally.

The accident airplane's three logbook entries regarding fuel leaks indicated the following:

- Aircraft Maintenance Log—September 23, 1995. During the preflight walk-around inspection, the flight engineer observed fuel dripping from the left wing dump chute while fueling was in progress. The drip stopped when fueling was terminated. The aircraft maintenance log entry contained the following engineering note: "this is an abnormal condition, possible dump valve problem. Pressure fuel system." No further leaks were noted.
- Nonroutine Maintenance Record—June 18, 1996. The No. 3 engine was removed because of an overtemperature, and a replacement engine was installed. The maintenance record indicated that maintenance personnel checked the operation of the cross-feed valve as part of the replacement engine installation in accordance with the maintenance manual instructions. During this procedure, an eight drop-per-minute leak was noted at the fuel shut-off valve. The logbook entry indicated that this leakage was within the limits specified in the maintenance manual, which states that leakage cannot exceed 20 drops per minute.
- Aircraft Maintenance Log—July 10, 1996. A small amount of fuel was found dripping from the flap assembly on the left wing behind the No. 2 engine. Maintenance personnel tightened the No. 1 main control fueling valve core mounting screws; no further leaks were noted.

The following text describes the 25 logbook entries regarding fuel flow; fuel gauge indications, inaccuracies, and fluctuations; and inoperable fuel system equipment and the corrective actions taken:

- Aircraft Maintenance Log—July 9, 1994. The "total fuel indication drums hang up and rotate along with the gross weight drums when gross weight is adjusted with set knob." The item was deferred until July 12, 1994, when the fuel totalizer indicator was replaced and the system was calibrated in accordance with the maintenance manual; the system subsequently passed a functional test.

- Aircraft Maintenance Log—July 30, 1994. The flight engineer's No. 2 engine fuel flow read higher than the other engines. A cross-feed check with the fuel used indicator and a quantity decrease confirmed a high fuel flow. All other engine parameters were normal. The fuel flow power supply was replaced, and the system passed a functional test.
- Aircraft Maintenance Log—August 1, 1994. Repeat of July 30, 1994, writeup. The item was deferred until August 3, 1995, when the No. 1 engine fuel flow transmitter was removed and replaced. The engine was run and fuel flow transmitter operation appeared normal; no leaks were noted.
- Aircraft Maintenance Log—August 4, 1994. The No. 1 reserve fuel tank lost fuel during flight. Maintenance personnel checked under the wing and the fuel transfer valve for leaks; none were found. The fuel quantity gauge reading matched the drip stick quantity indication. The fuel tank sumps were drained.
- Aircraft Maintenance Log—August 10, 1994. The No. 1 reserve fuel tank lost fuel during flight. The fuel tank sumps were drained, and the fuel quantity gauge reading matched the drip stick quantity indication. The item was deferred until August 18, 1994, when the No. 1 reserve fuel tank successfully completed an operational check.
- Aircraft Maintenance Log—November 21, 1994. The No. 1 reserve fuel quantity indicator was inoperative. The indicator connector was cleaned and resealed, and the indicator operation checked normal.
- Aircraft Maintenance Log—February 3, 1995. The fuel totalizer indication was inaccurate. The ramp indicator indicated 241,200 pounds of fuel on board, and the fuel totalizer indicated 246,700 pounds. Maintenance personnel indicated that fuel totals were within maintenance manual limits.
- Aircraft Maintenance Log—February 3, 1995 (after another flight). The fuel totalizer indication was inaccurate. The ramp indicator indicated 187,500 pounds of fuel on board, and the fuel totalizer indicated 191,400 pounds. During flight, the totalizer indication was consistent with the total of the individual gauge quantity indications. The item was deferred until February 5, 1995, when the totalizer was recalibrated in accordance with the maintenance manual procedures, and its operation checked normal.
- Aircraft Maintenance Log—February 11, 1995. The captain's No. 2 fuel flow indication was inaccurate (high). The fuel used indication was high from engine start until takeoff. Maintenance personnel tested the fuel flow module, and its operation checked normal.
- Aircraft Maintenance Log—April 28, 1995. The fuel temperature indication was lower than the actual temperature in all positions (15° low on Nos. 1, 3, and 4 engines; 20° low on No. 2 engine). The item was deferred until April 29, 1995, when the fuel temperature indicator was removed and replaced.

- Aircraft Maintenance Log—May 5, 1995. The fuel temperature indication for engine No. 2 was higher than the actual temperature. The item was deferred until May 6, 1995, when the fuel temperature bulb was removed and replaced.
- Aircraft Maintenance Log—May 18, 1995. The gross weight/total fuel weight indication was inaccurate. This gauge indicated 1,500 pounds less than the sum of the individual tank gauges. The item was deferred until May 21, 1995, when the indicator checked within maintenance manual limits.
- Aircraft Maintenance Log—July 20, 1995. The No. 1 main fuel tank quantity indicator was inaccurate. The item was deferred until August 5, 1995, when the No. 1 main fuel tank quantity indicator was removed and replaced. Full and empty capacitance was checked, and the indicator and totalizer were calibrated per maintenance manual references. All of the systems checked normal.
- Aircraft Maintenance Log—August 3, 1995. An engineering note stated that the No. 1 fuel gauge should be placarded inoperative because of an “existing fuel problem. Suspect possibility of fuel siphoning from the number 1 tank (when boost pumps are off) into fuel manifold.” No external fuel leaks were noted, and no transfer of fuel occurred when the fuel manifolds were pressurized. Engine fuel burn appeared normal. The item was closed out on August 21, 1995.
- Aircraft Maintenance Log—August 4, 1995. An engineering note stated that the center wing fuel tank (CWT) fuel quantity indicator showed 1,300 pounds when the analog fuel quantity needle indicated that the tank was empty. The item was deferred until August 5, 1995, when the CWT fuel quantity indicator was removed and replaced. Full and empty capacitance was checked, and the indicator and totalizer were calibrated per maintenance manual references. All of the systems checked normal.
- Aircraft Maintenance Log—August 15, 1995. The flight engineer’s fuel flow indicator was inoperative. Examination revealed no problems with the fuel or the forward panel fuel flow indicator. The No. 4 fuel flow indicator was removed and replaced, and the system checked normal.
- Aircraft Maintenance Log—August 23, 1995. The flight engineer’s No. 4 fuel flow indicator stuck at 7,900 pounds. The pilot’s fuel flow gauges were normal. The item was deferred until August 24, 1995, when the fuel flow indicator was removed and replaced.
- Aircraft Maintenance Log—October 9, 1995. An engineering note indicated that the wing quantity gauges and the flight engineer’s fuel quantity gauges were to be checked against the actual fuel quantity before the airplane was fueled because of fuel quantity discrepancies. According to the note, all operations checked normal.
- Nonroutine Maintenance Record—December 1, 1995. The No. 1 engine fuel flow indicator was inoperative. Maintenance personnel checked the fuel flow, and all operations checked normal.

- Aircraft Maintenance Log—December 4, 1995. The flight engineer's No. 1 engine fuel flow indicator was inoperative. The fuel flow indicator was replaced, the No. 1 fuel flow transmitter connector was cleaned, and the indicator appeared to operate normally.
- Aircraft Maintenance Log—December 17, 1995. The No. 4 reserve fuel tank quantity indicator was inoperative. The item was deferred until December 17, 1995, when the wing and cockpit indicators were replaced. The cockpit and wing indicators' full and empty indications were calibrated, and volumetric operations checked normal.
- Aircraft Maintenance Log—December 17, 1995. The CWT fuel quantity gauge indication was erratic and fluctuated between 0 and 2,000 pounds when the CWT was empty. The indicator calibration full/empty volumetric totalizer was replaced, and the gauge appeared to operate normally.
- Aircraft Maintenance Log—December 28, 1995. The No. 1 engine fuel flow indication fluctuated. The item was deferred until January 1, 1996, when a byte check was performed on the fuel flow amperage.
- Aircraft Maintenance Log—April 27, 1996. The No. 1 engine fuel flow numerals indicated 10,000 pounds per hour above the pointer value. The fuel used and pilot's gauges appeared to indicate normally. The No. 1 engine fuel flow indicator was replaced and appeared to operate normally.
- Aircraft Maintenance Log—May 13, 1996. Both of the No. 4 engine fuel flow indicators were pegged high and inoperative. The item was deferred until May 15, 1996, when maintenance personnel performed a byte check on the electronic unit. All tests were passed, and maintenance personnel suspected wiring. On May 16, 1996, maintenance personnel cleaned and secured the fuel flow transmitter connector with no improvement noted. On May 18, 1996, maintenance personnel replaced the No. 4 transmitter, and the engine fuel flow operation checked normal.

Appendix F

Sooting and Fracture Diagrams

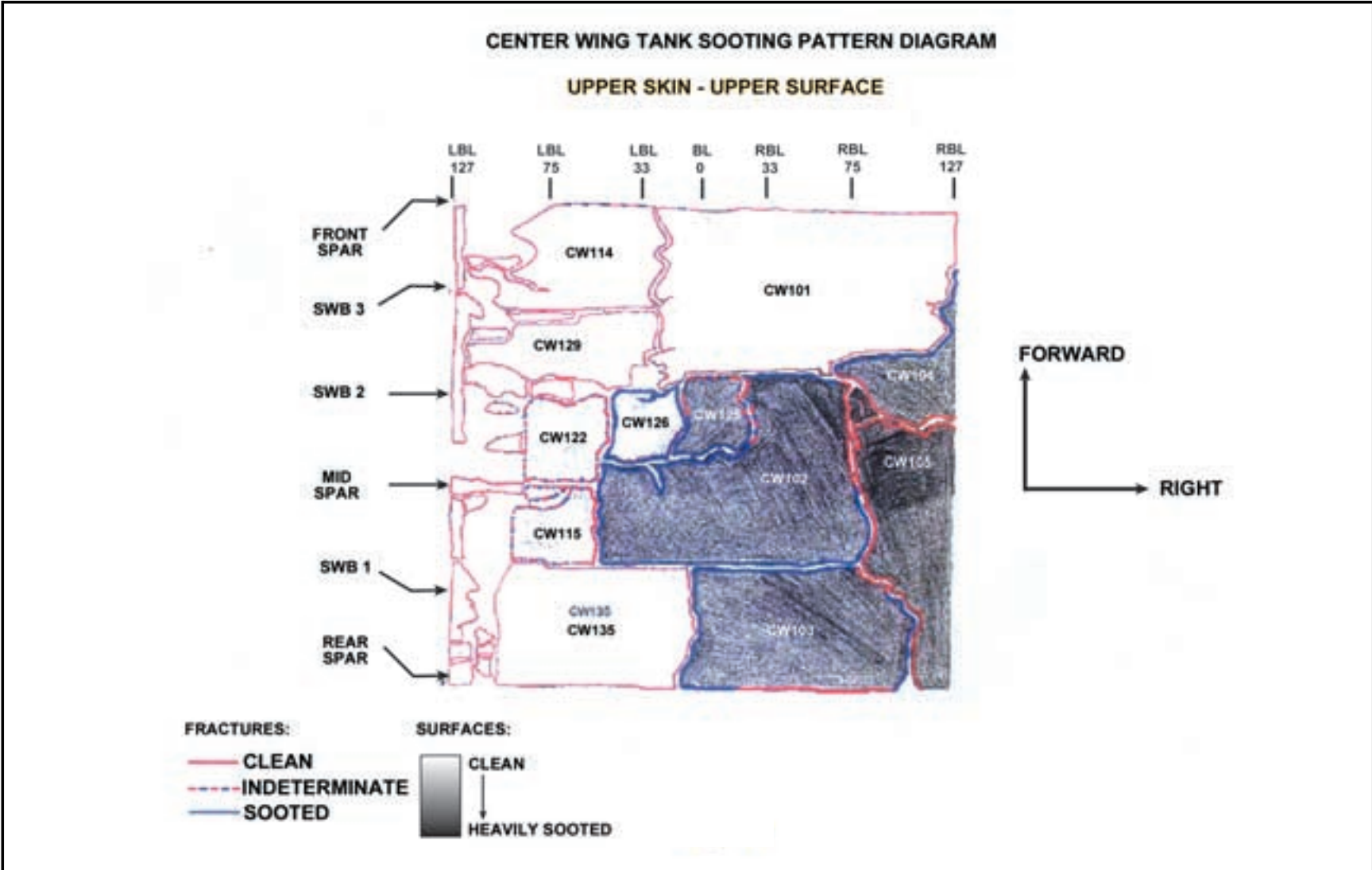

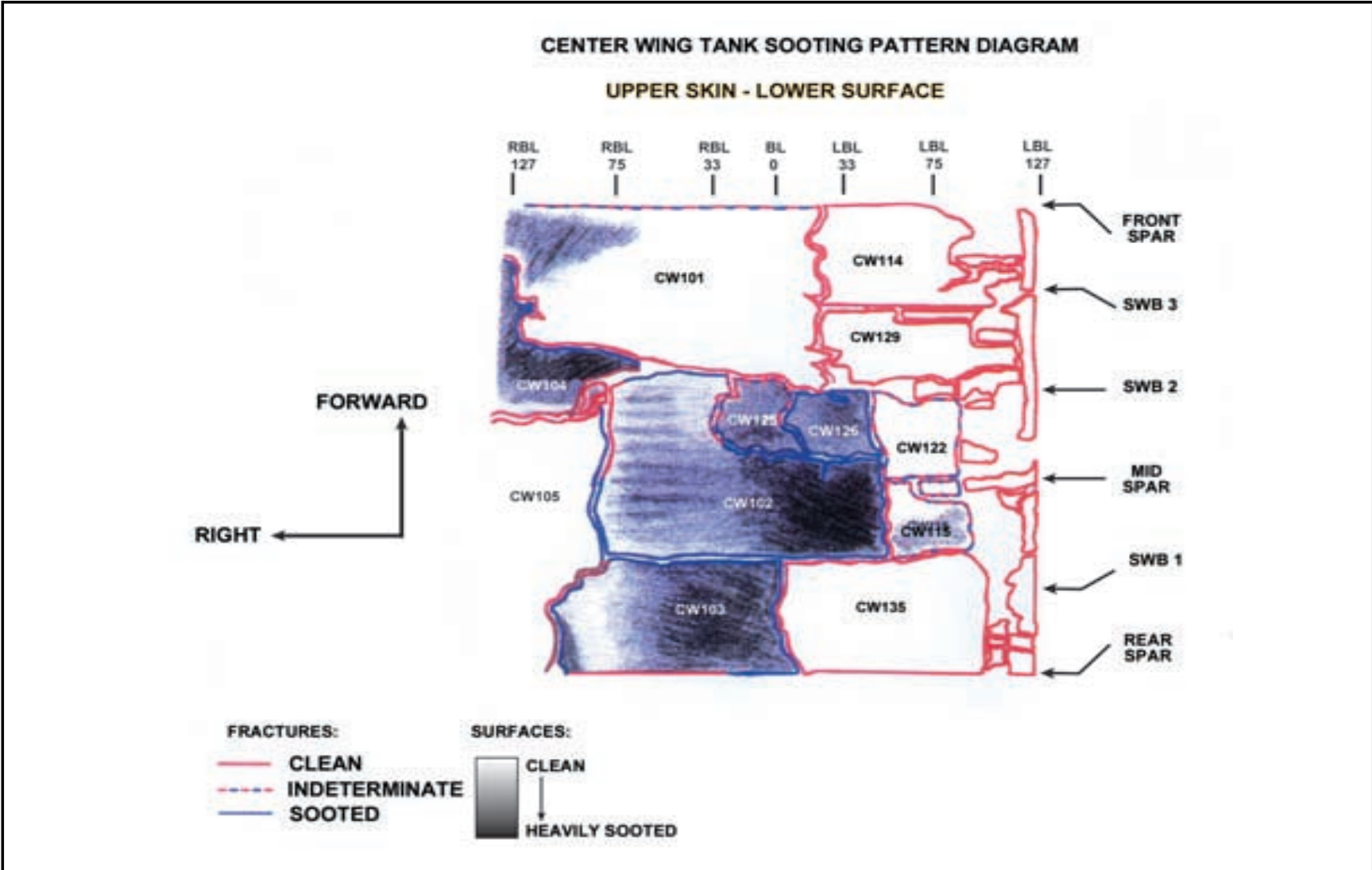

**CENTER WING TANK SOOTING PATTERN DIAGRAM
LOWER SKIN - UPPER SURFACE**

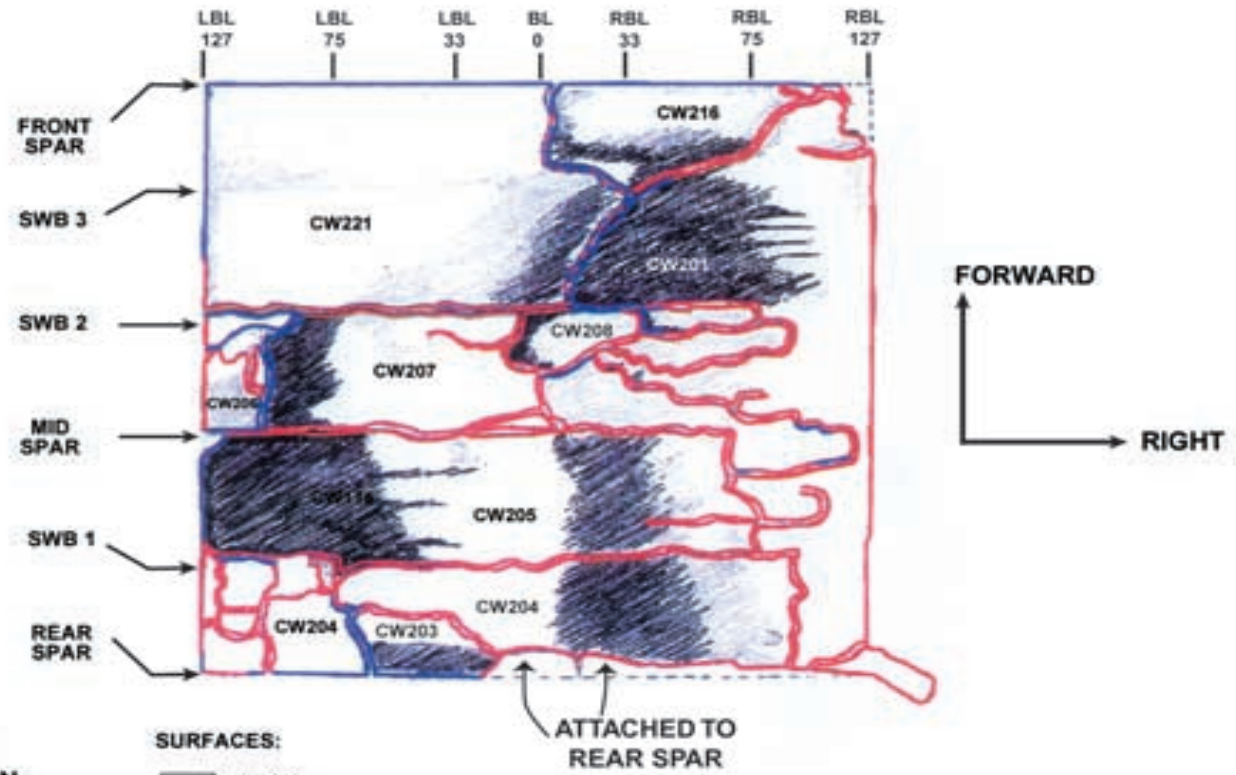

FRACTURES:
 — CLEAN
 - - - INDETERMINATE
 — SOOTED

SURFACES:
 [Light Gray Box] CLEAN
 ↓
 [Dark Gray Box] HEAVILY SOOTED

CENTER WING TANK SOOTING PATTERN DIAGRAM

LOWER SKIN - LOWER SURFACE

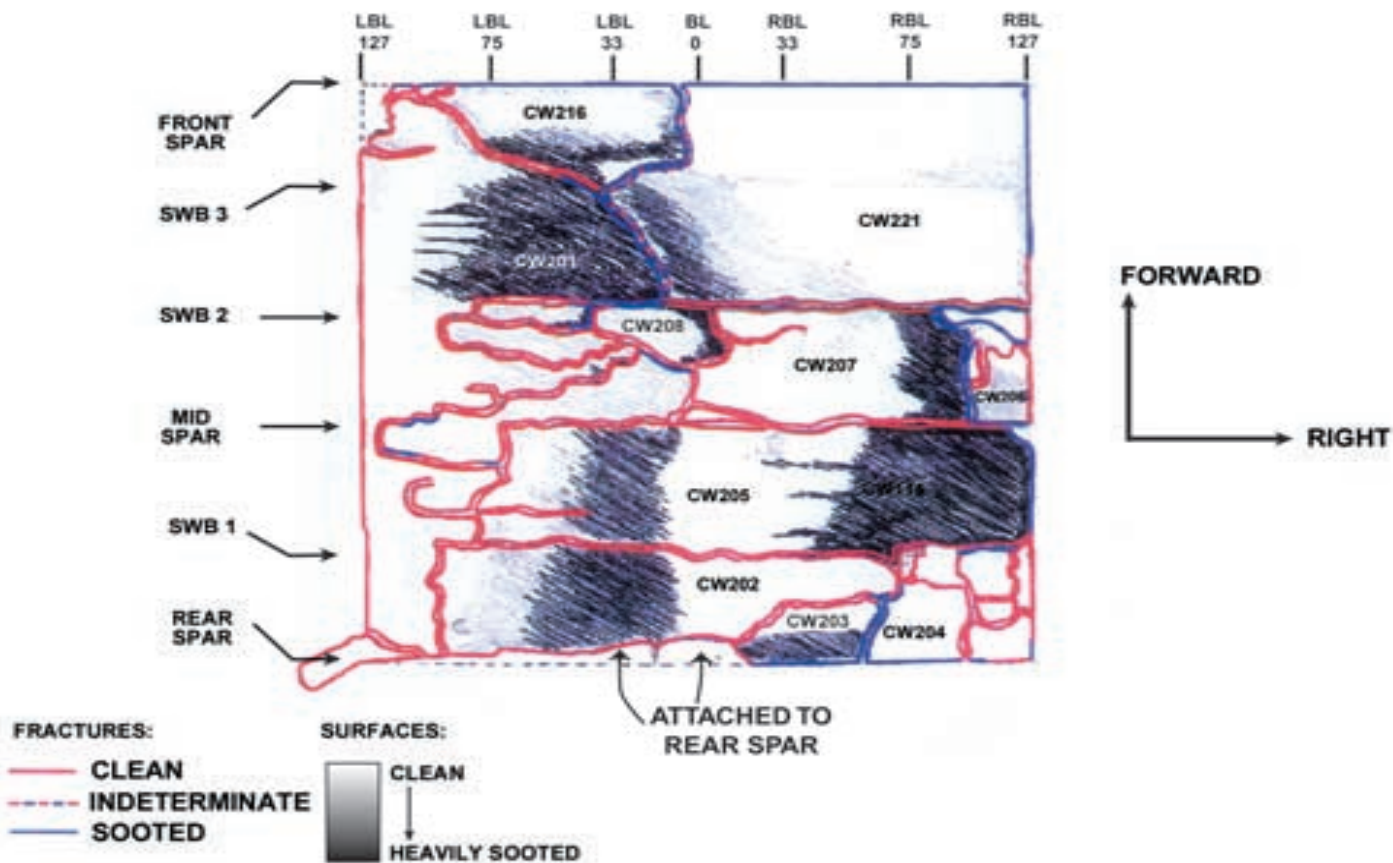

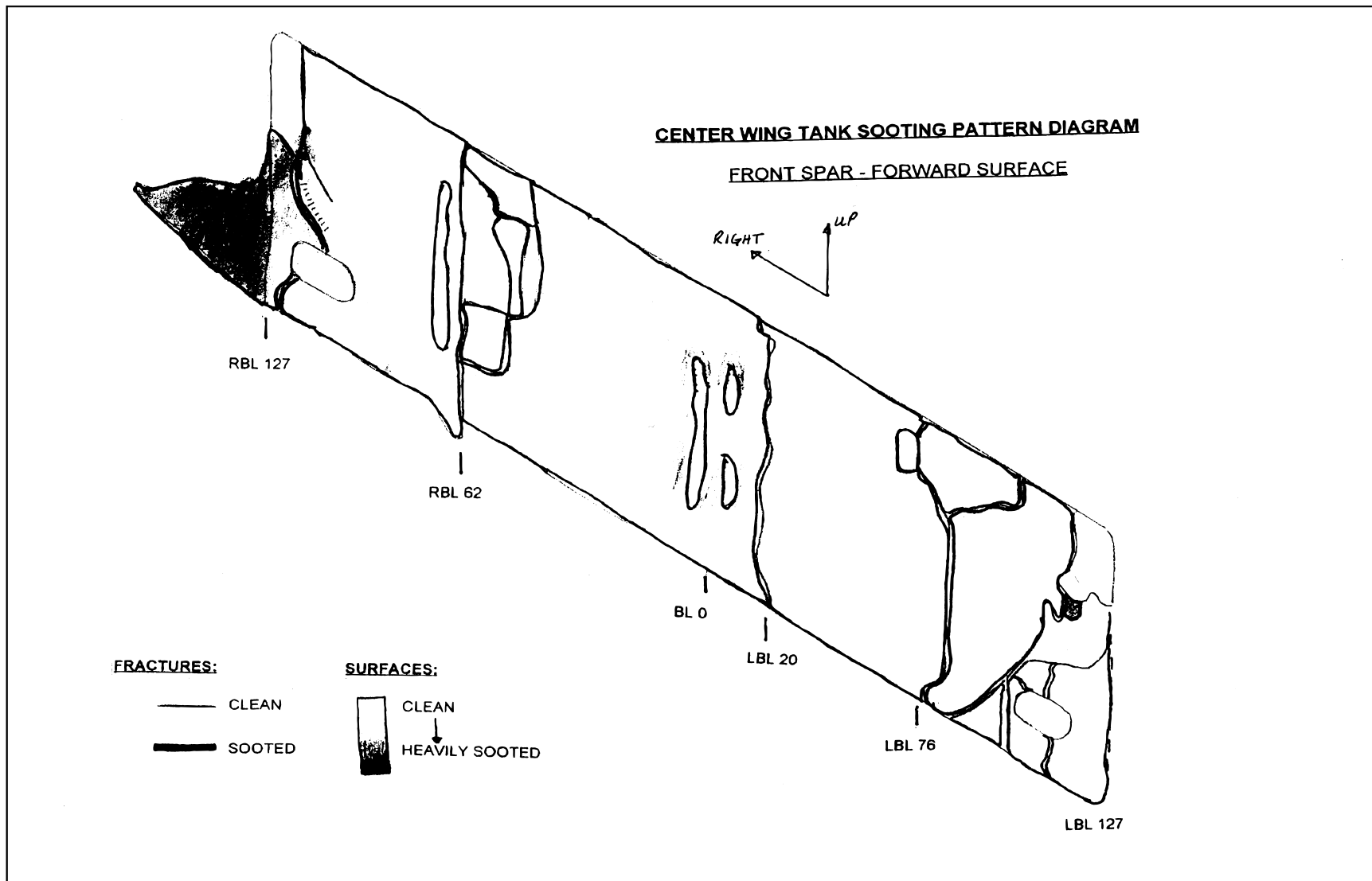

CENTER WING TANK SOOTING PATTERN DIAGRAM

FRONT SPAR - AFT SURFACE

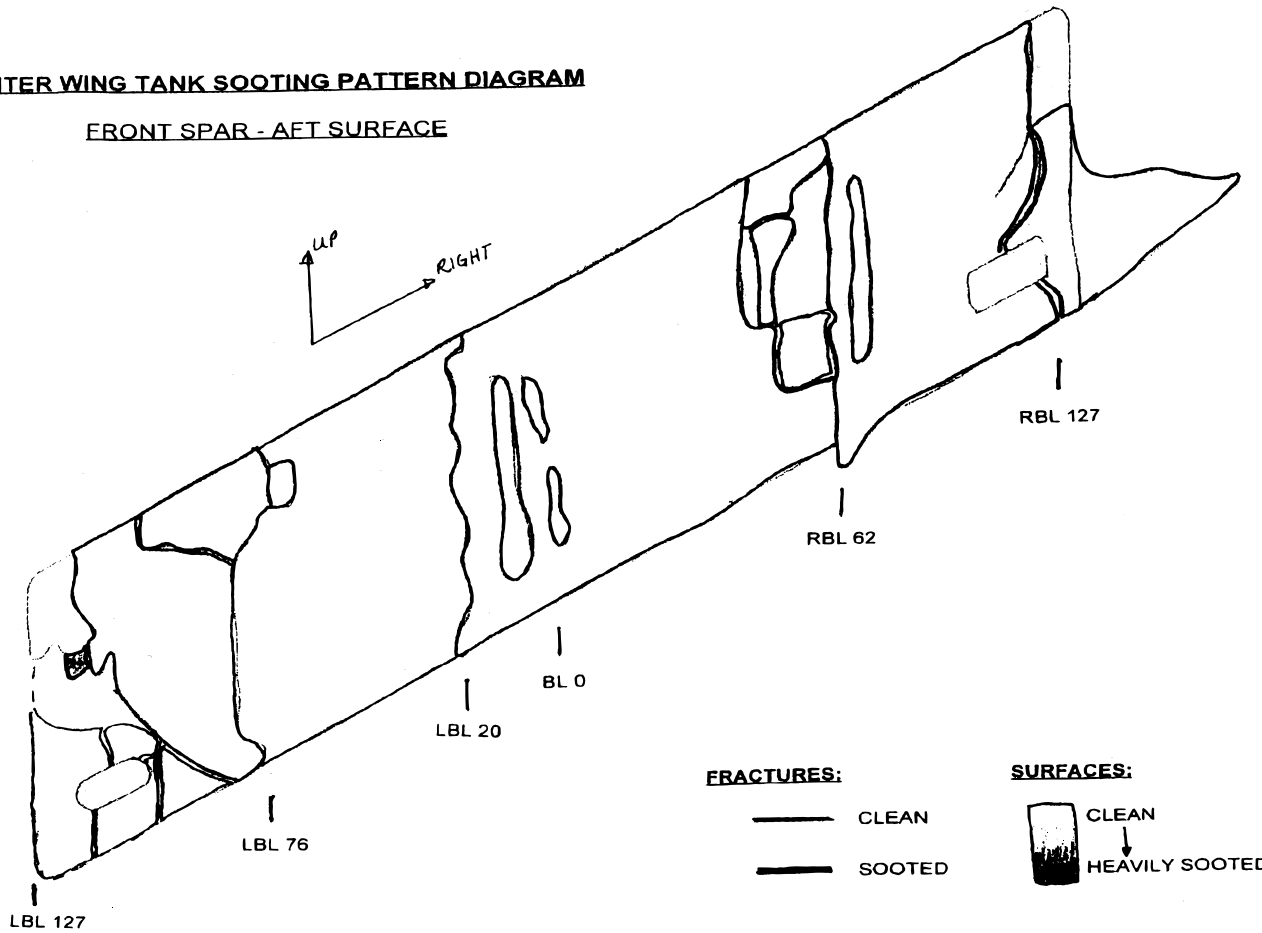

CENTER WING TANK SOOTING PATTERN DIAGRAM

SPANWISE BEAM #3 - FORWARD SURFACE

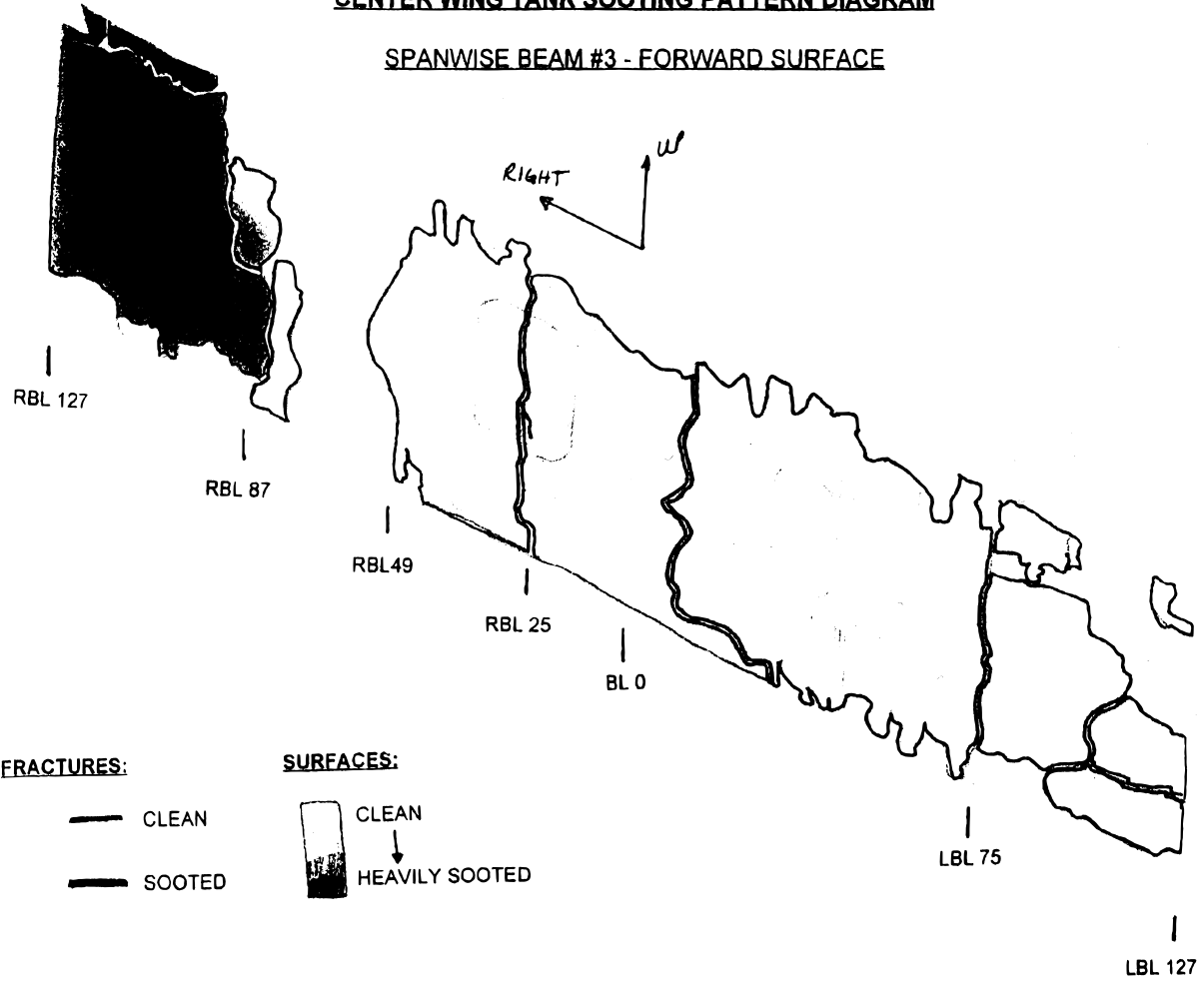

CENTER WING TANK SOOTING PATTERN DIAGRAM

SPANWISE BEAM #3 - AFT SURFACE

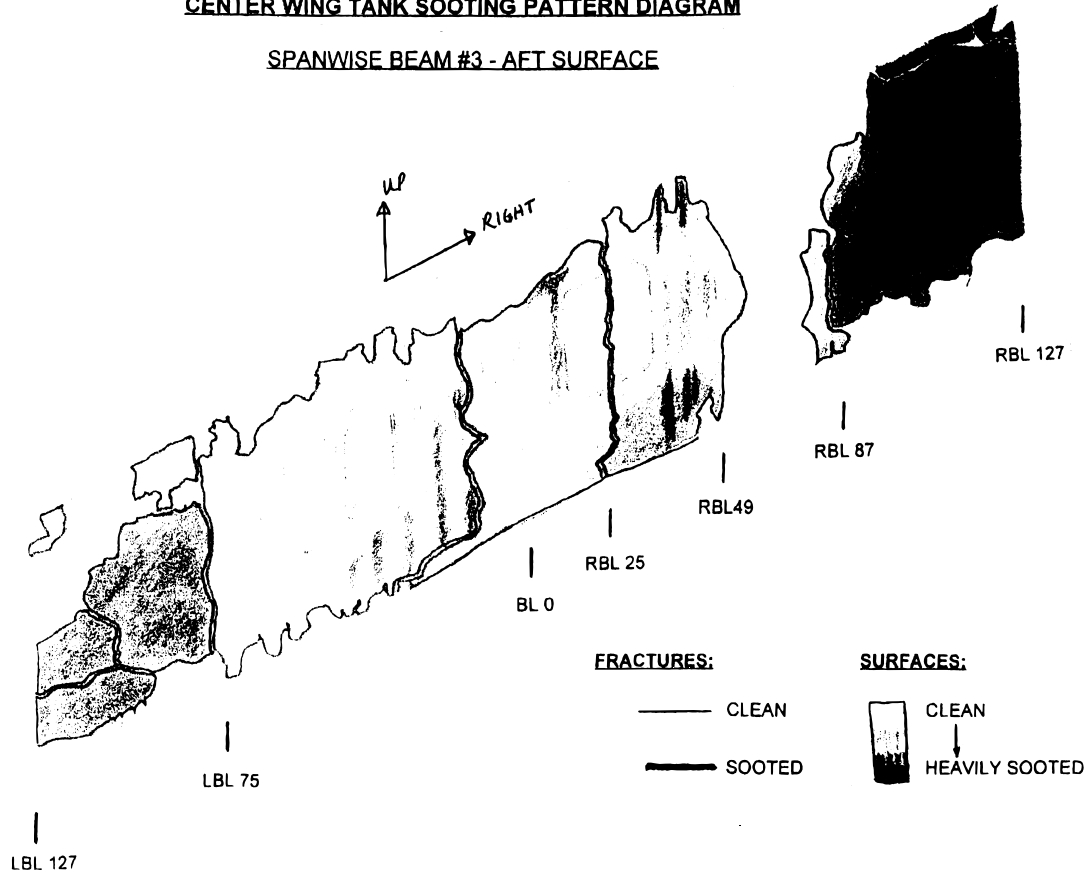

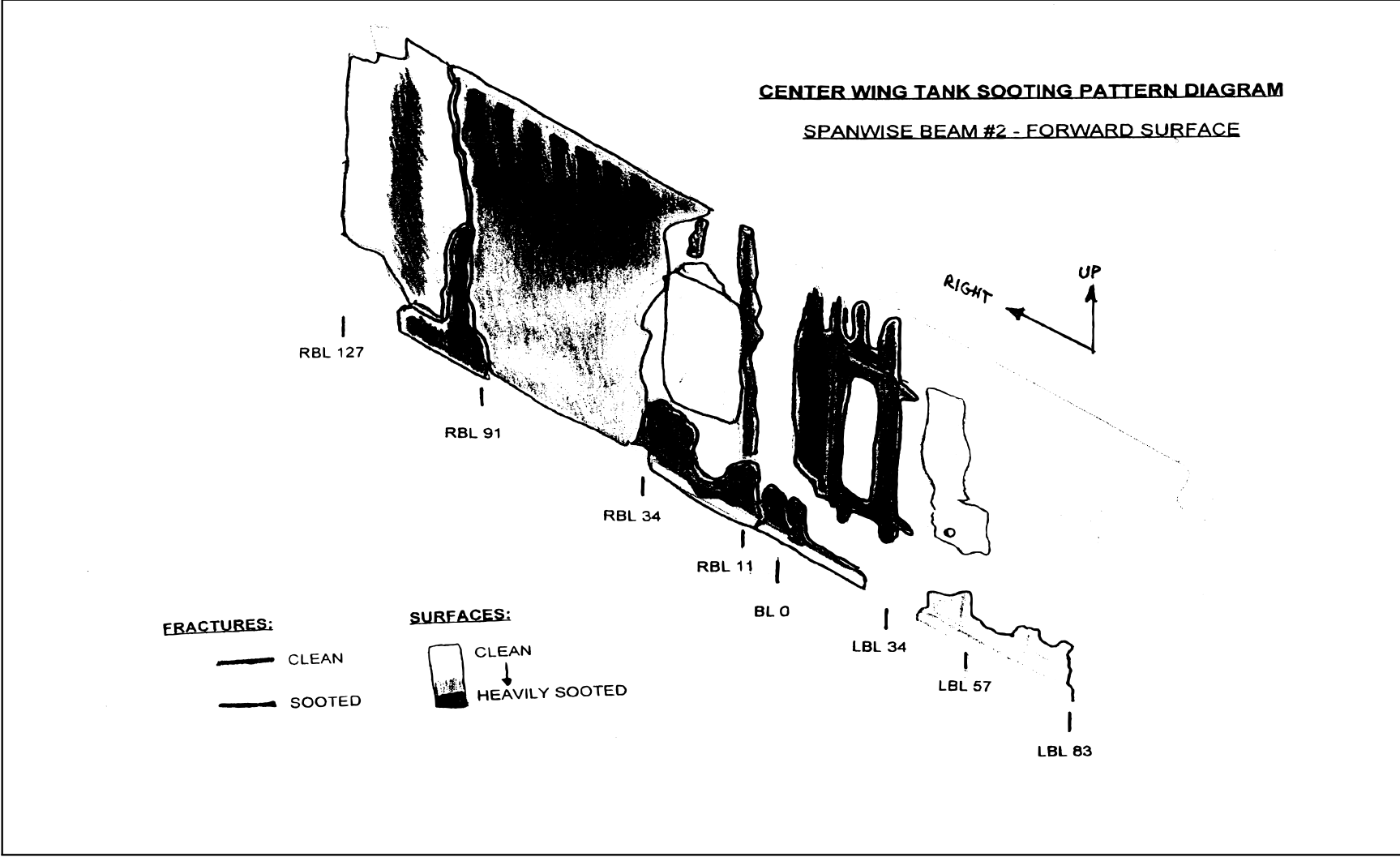

CENTER WING TANK SOOTING PATTERN DIAGRAM

SPANWISE BEAM #2 - AFT SURFACE

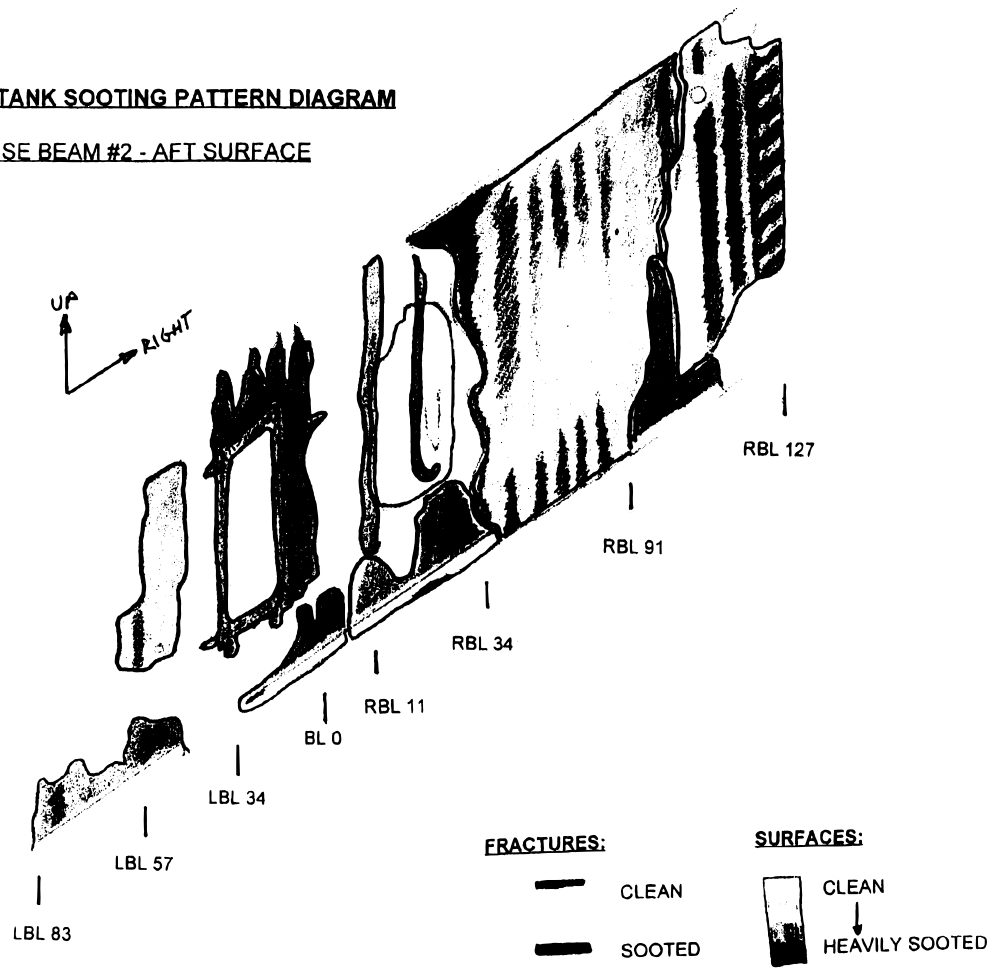

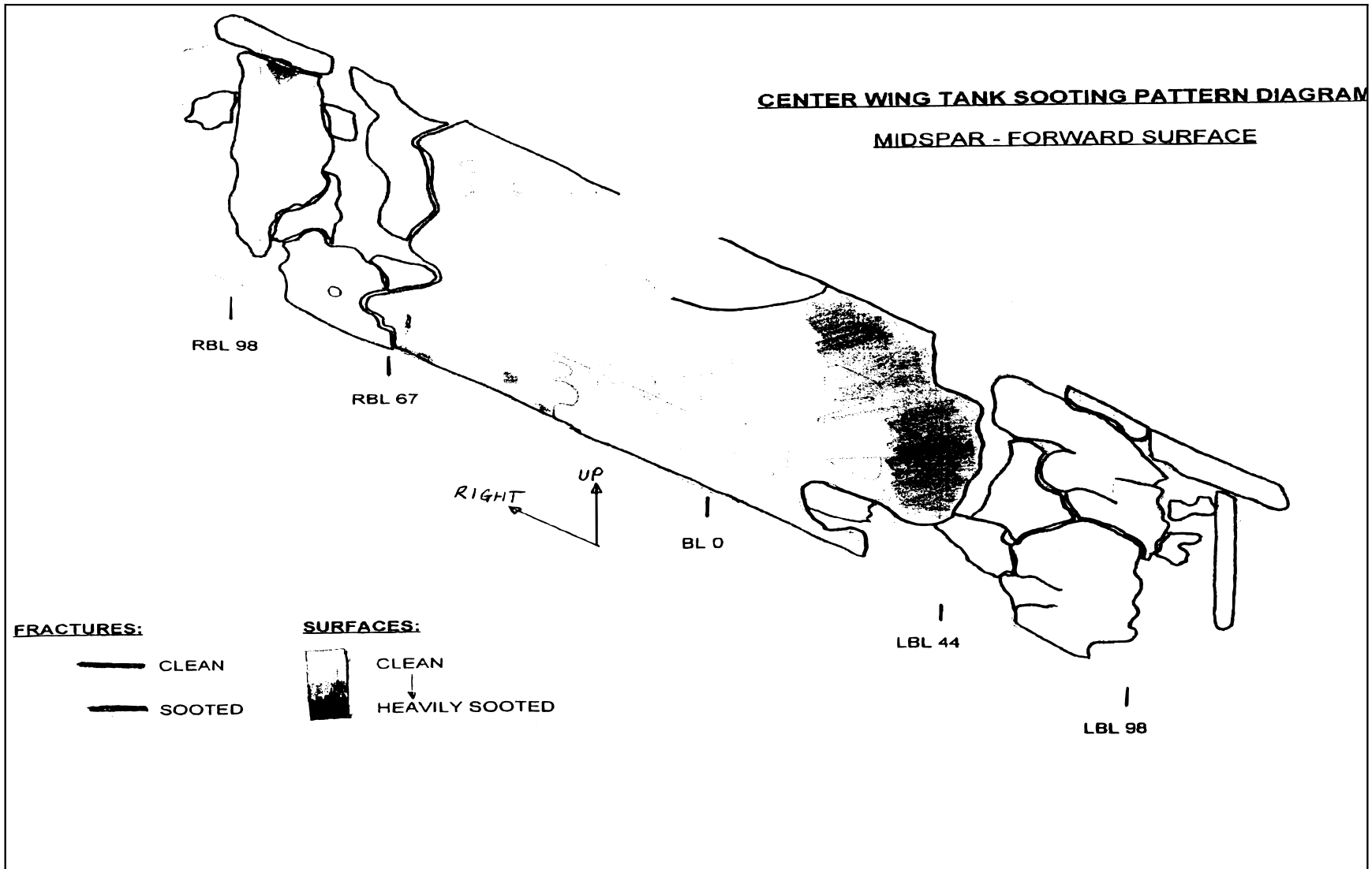

CENTER WING TANK SOOTING PATTERN DIAGRAM

MIDSPAR - AFT SURFACE

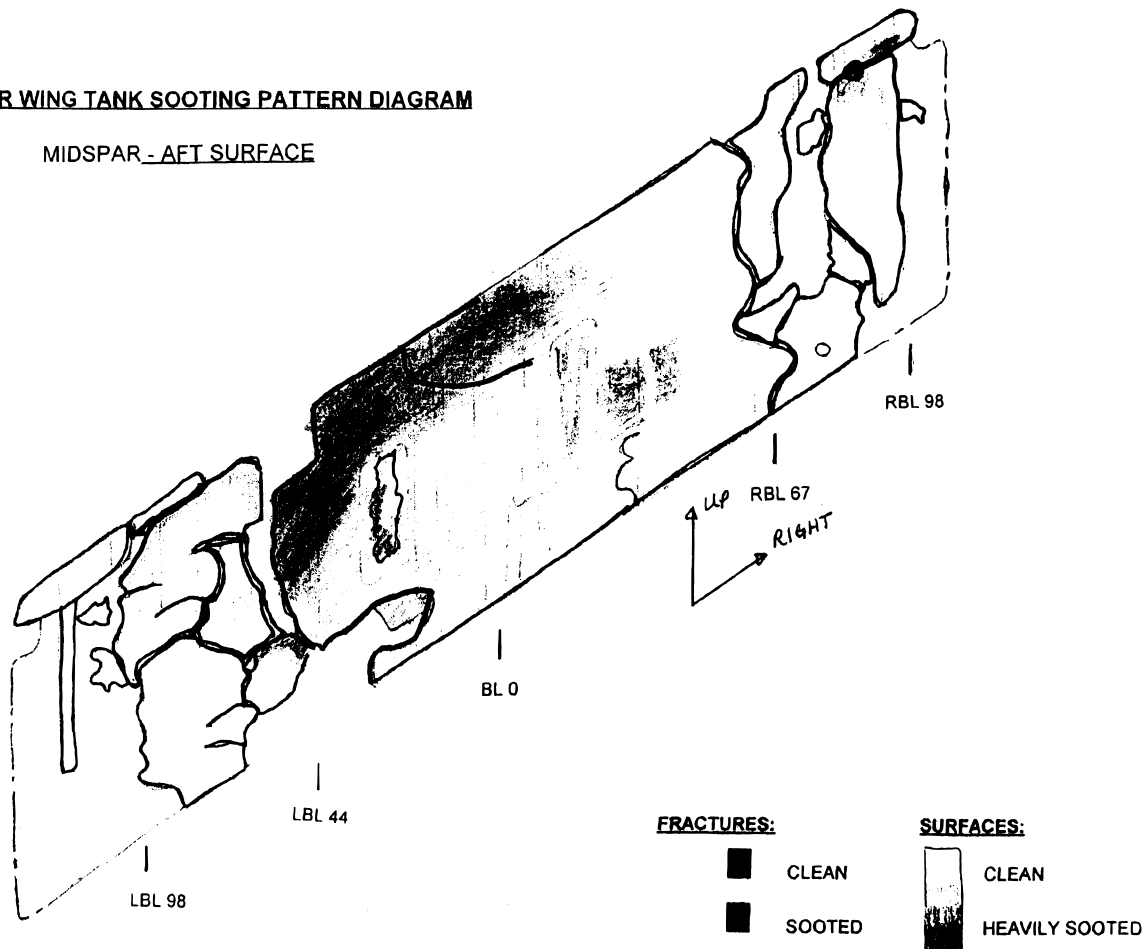

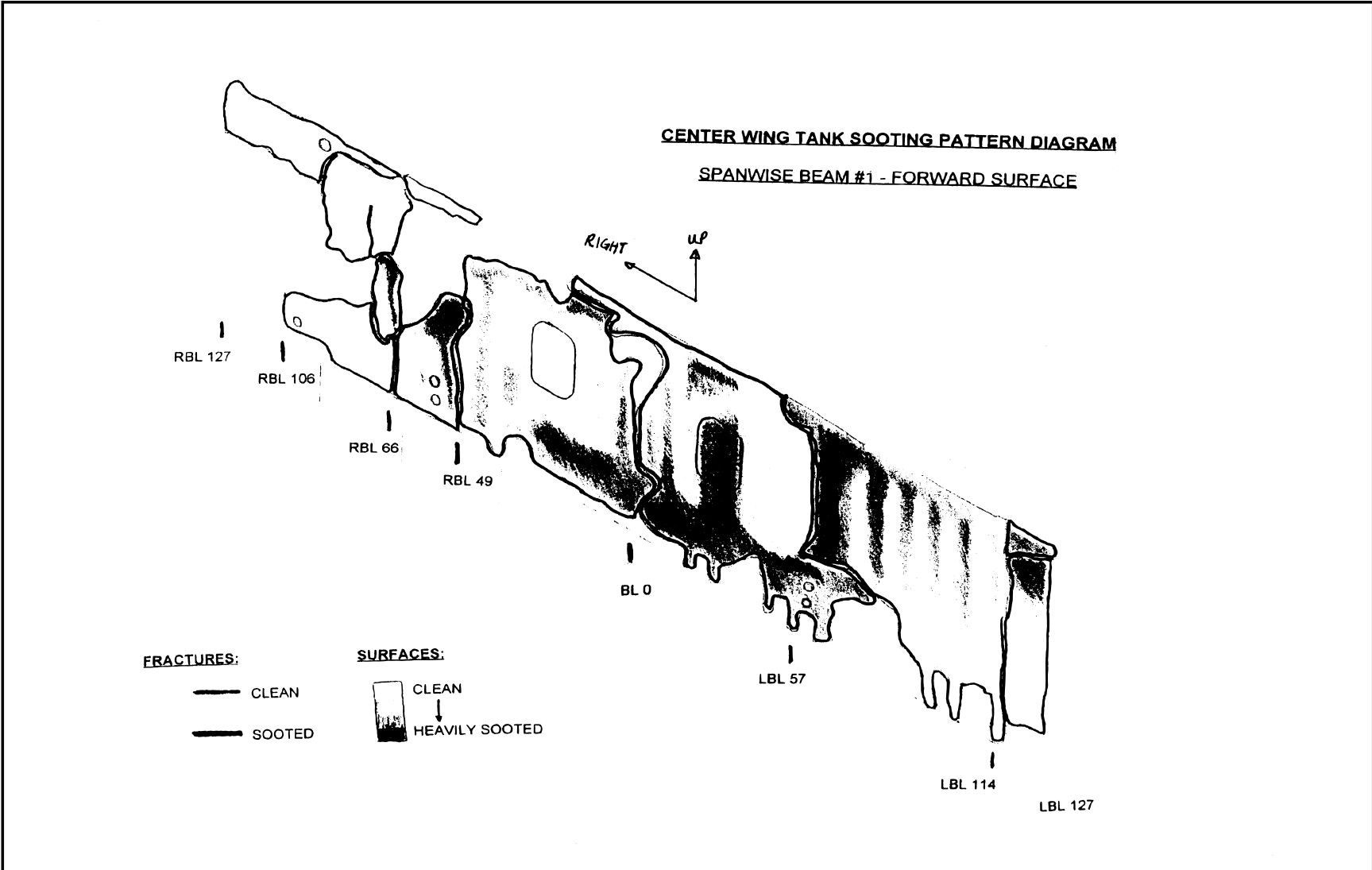

CENTER WING TANK SOOTING PATTERN DIAGRAM

SPANWISE BEAM #1 - AFT SURFACE

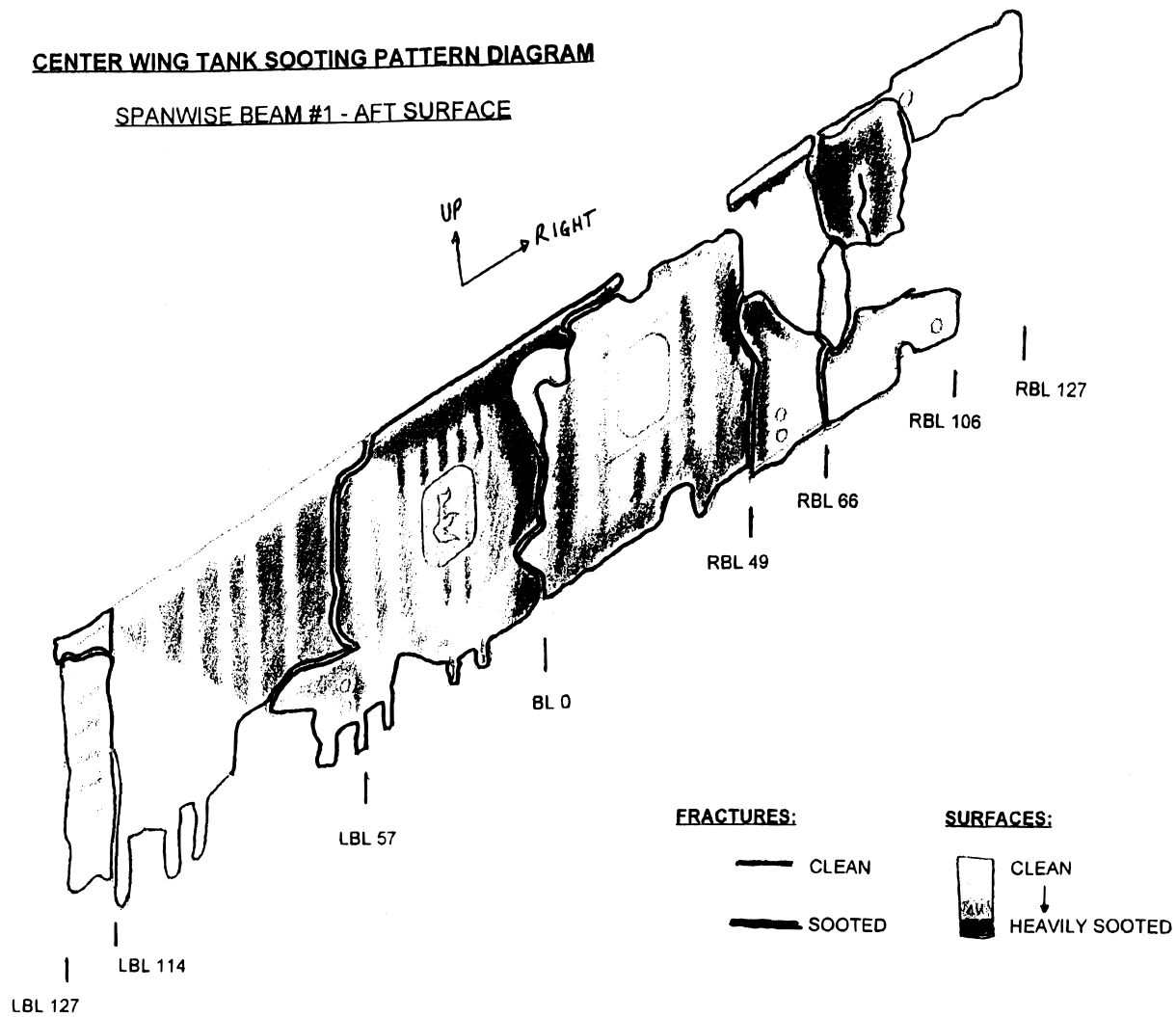

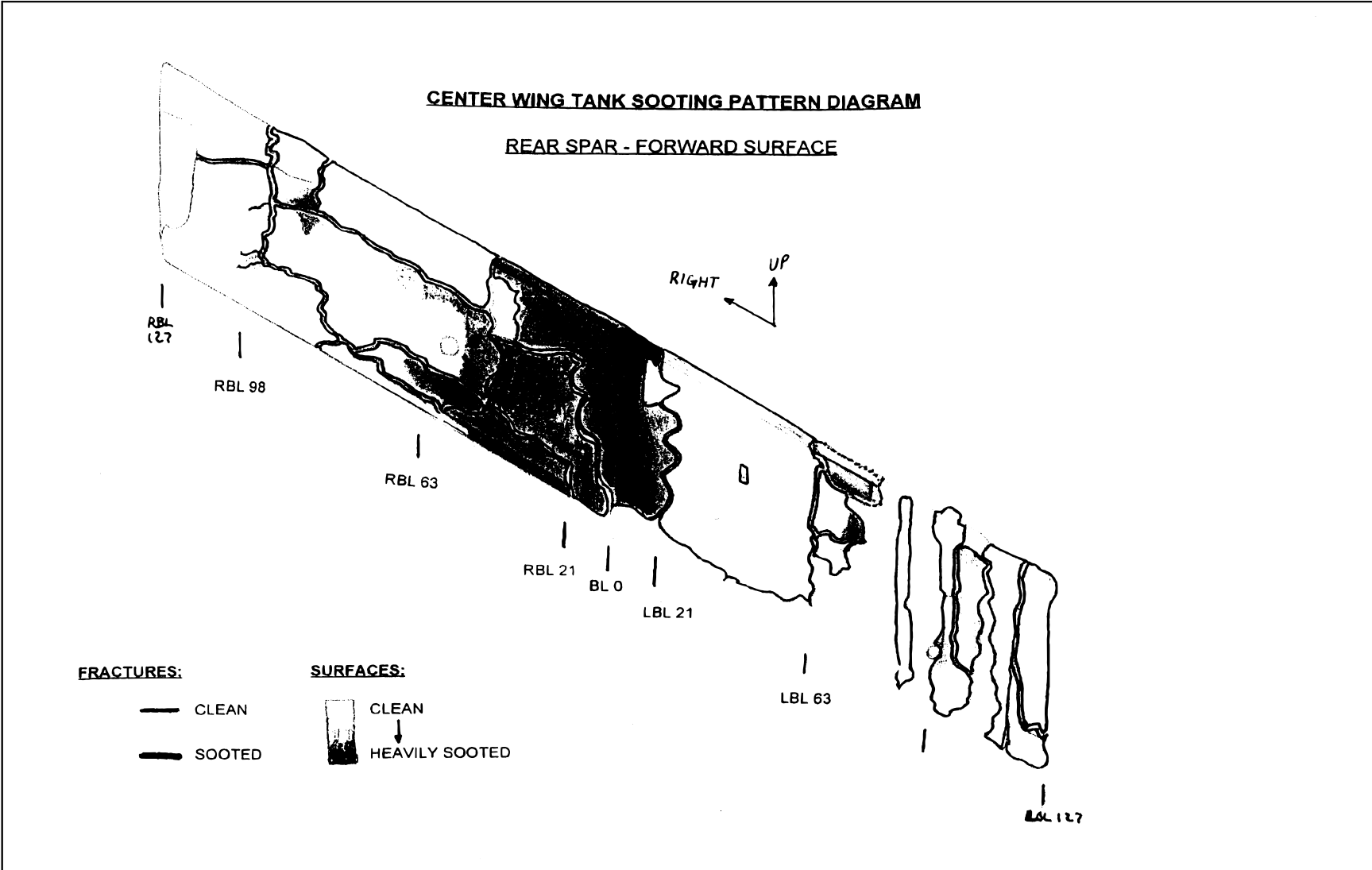

CENTER WING TANK SOOTING PATTERN DIAGRAM

REAR SPAR - AFT SURFACE

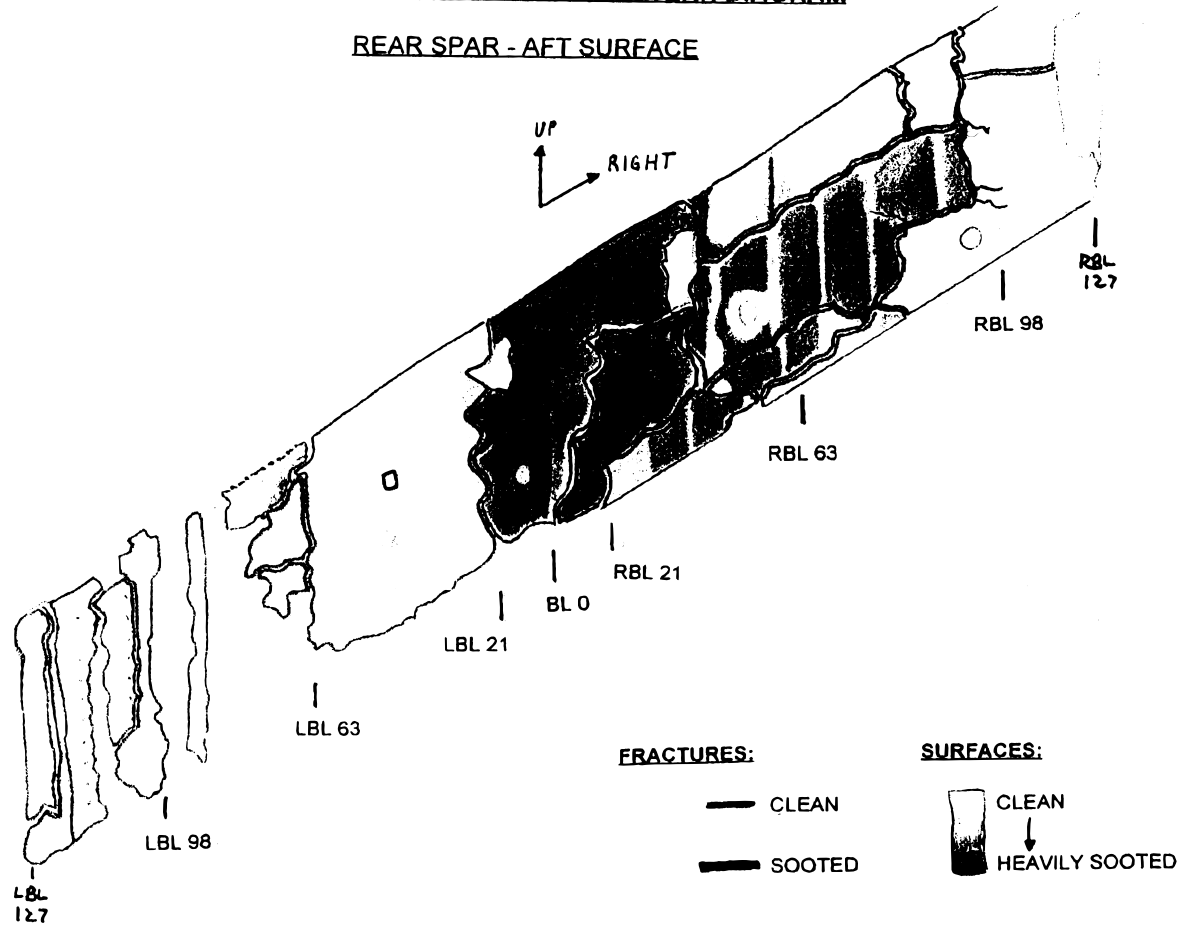

CENTER WING TANK SOOTING PATTERN DIAGRAM

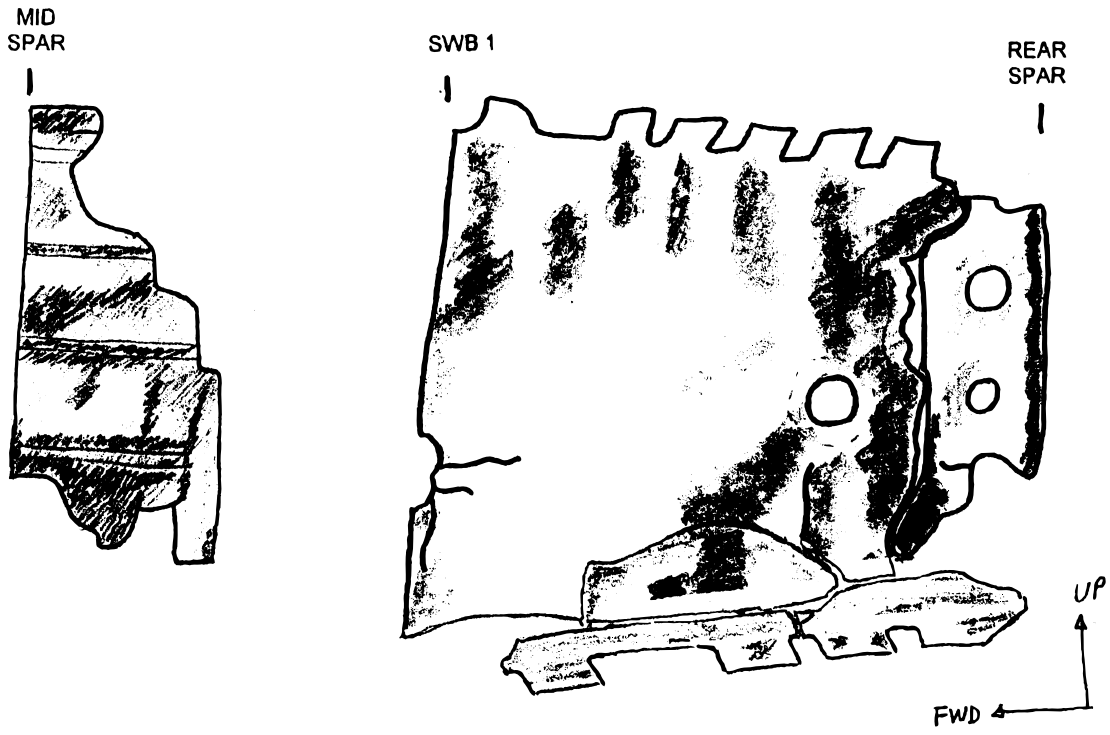

BL 0 RIB - LEFT SURFACE



FRACTURES:

-  CLEAN
-  SOOTED

SURFACES:

-  CLEAN
- 
-  HEAVILY SOOTED

CENTER WING TANK SOOTING PATTERN DIAGRAM

BL 0 RIB - RIGHT SURFACE

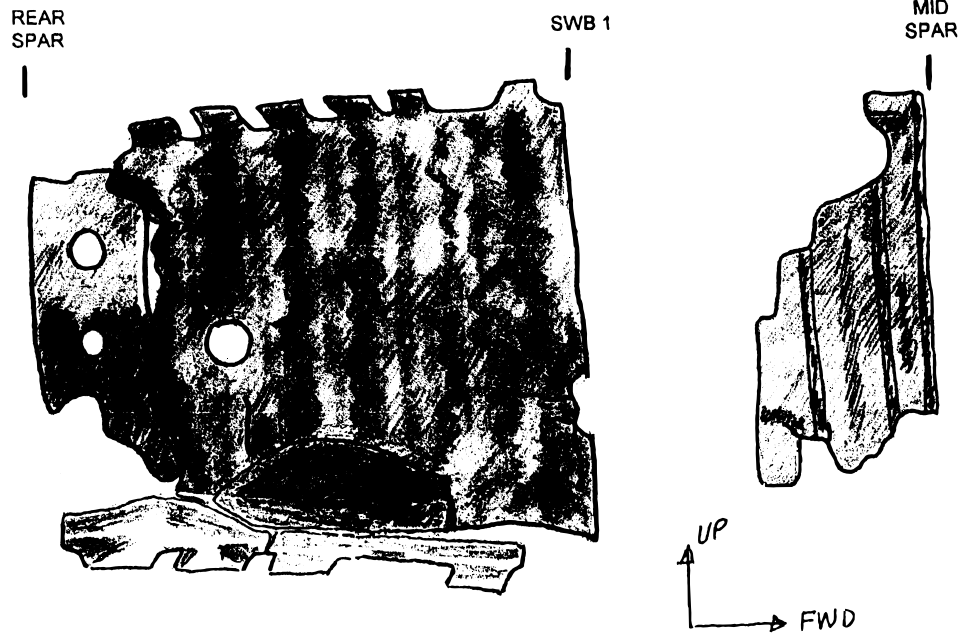

FRACTURES:

- CLEAN
- SOOTED

SURFACES:



- CLEAN
- ↓
- HEAVILY SOOTED

CENTER WING TANK SOOTING PATTERN DIAGRAM

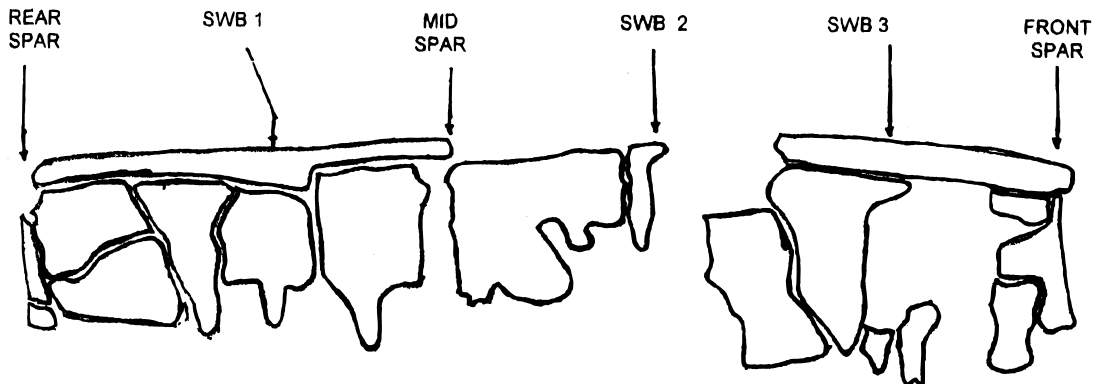

RIGHTHAND SIDE OF BODY RIB - OUTBOARD SURFACE



FRACTURES:

-  CLEAN
-  SOOTED

SURFACES:

-  CLEAN
-  HEAVILY SOOTED



CENTER WING TANK SOOTING PATTERN DIAGRAM
RIGHTHAND SIDE OF BODY RIB - INBOARD SURFACE

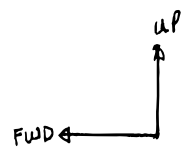
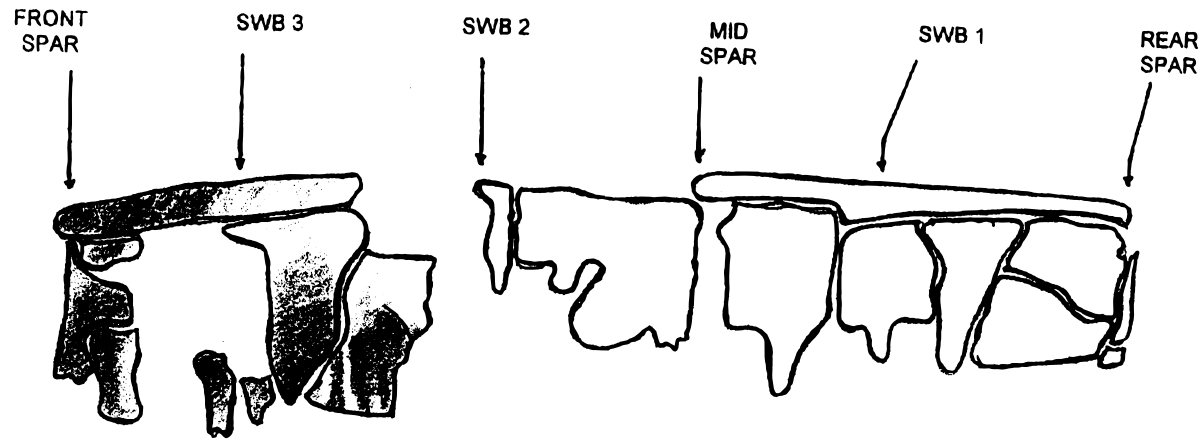

FRACTURES:

- CLEAN
- SOOTED

SURFACES:

- CLEAN
- HEAVILY SOOTED

CENTER WING TANK SOOTING PATTERN DIAGRAM
LEFTHAND SIDE OF BODY RIB - OUTBOARD SURFACE

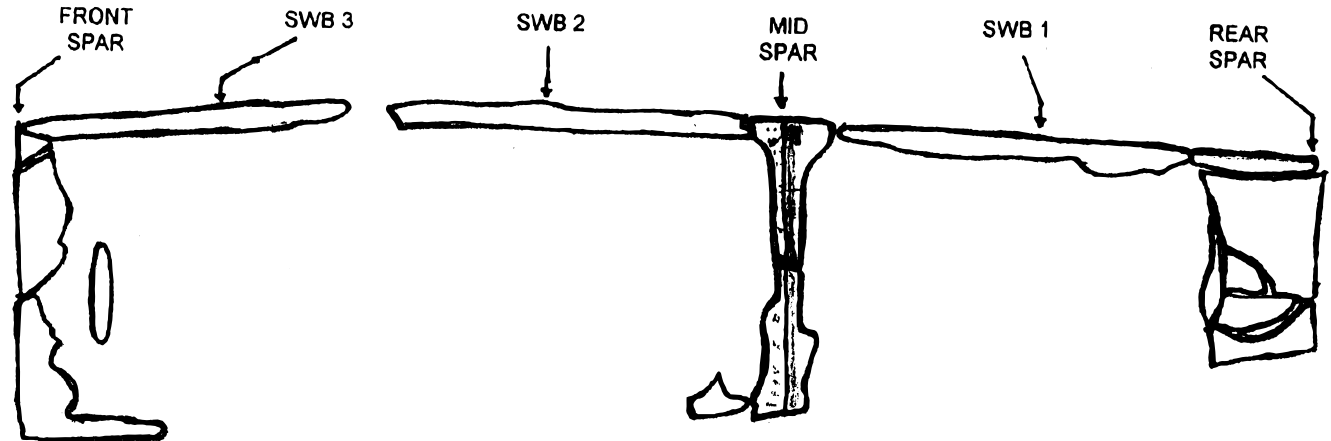

FRACTURES:

- CLEAN
- SOOTED



SURFACES:

- CLEAN
- HEAVILY SOOTED

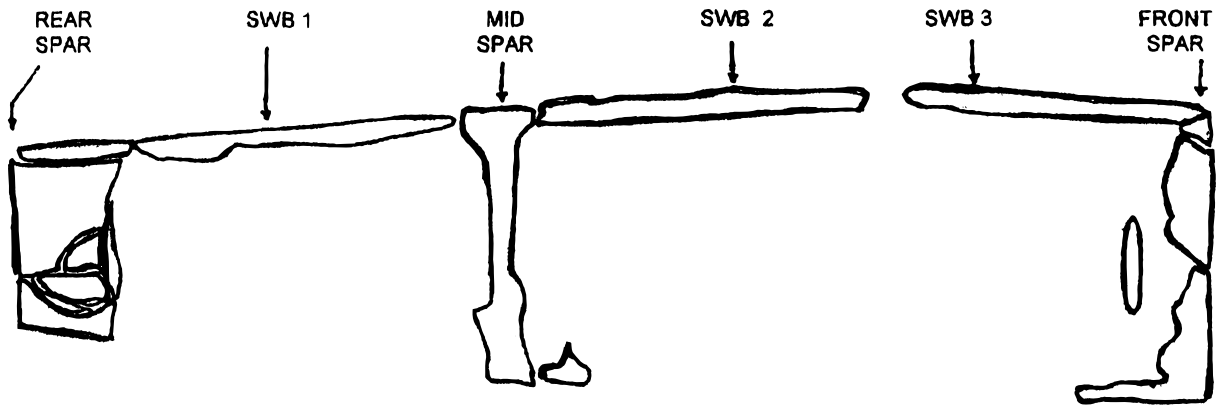

CENTER WING TANK SOOTING PATTERN DIAGRAM
LEFTHAND SIDE OF BODY RIB - INBOARD SURFACE



FRACTURES:

-  CLEAN
-  SOOTED

SURFACES:

-  CLEAN
-  HEAVILY SOOTED

RIGHT WING SOOTING PATTERN DIAGRAM

UPPER SKIN - EXTERNAL SURFACE

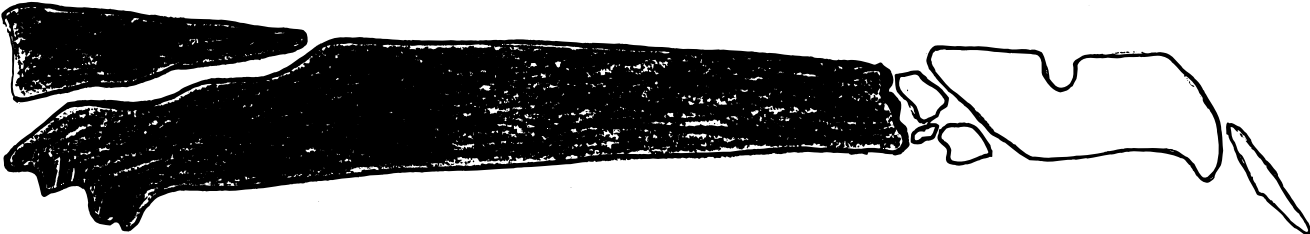

LOWER SKIN - EXTERNAL SURFACE

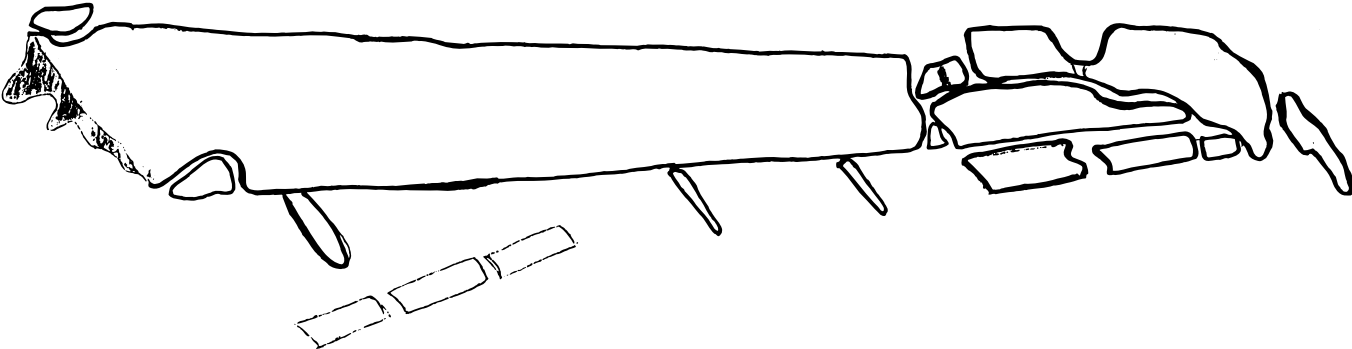

FRACTURES:

- CLEAN
- SOOTED

SURFACES:

- CLEAN
- ▬ HEAVILY SOOTED

RIGHT WING SOOTING PATTERN DIAGRAM

UPPER SKIN - INTERNAL SURFACE

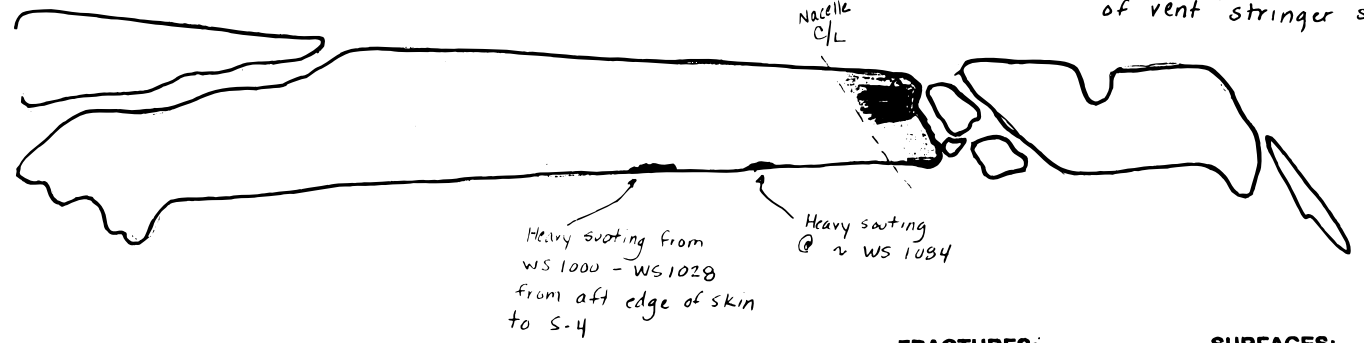

NOTE: See Vent stringer soot diagram for details of vent stringer sooting.

LOWER SKIN - INTERNAL SURFACE

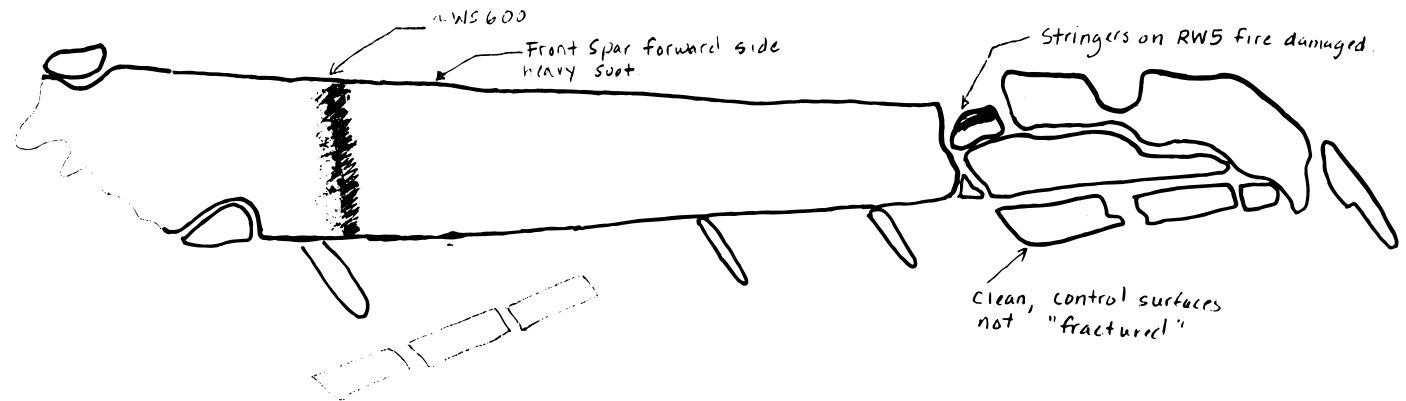

FRACTURES:



SURFACES:

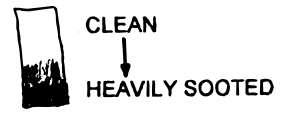

LEFT WING SOOTING PATTERN DIAGRAM

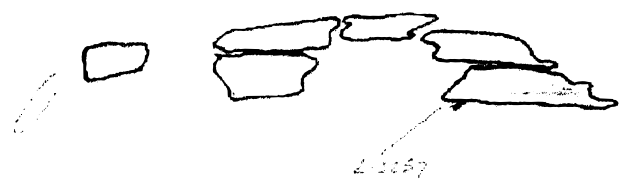

NOTE: Many small pieces of the upper skin are not shown on the diagram.

UPPER SKIN - EXTERNAL SURFACE





NOTE: With the exception of the piece noted, the external surface of the upper skin is clean. The control surfaces do show sooting and Arc damage to the composite parts.

FRACTURES:

-  CLEAN
-  SOOTED

SURFACES:

-  CLEAN
-  HEAVILY SOOTED

LOWER SKIN - EXTERNAL SURFACE

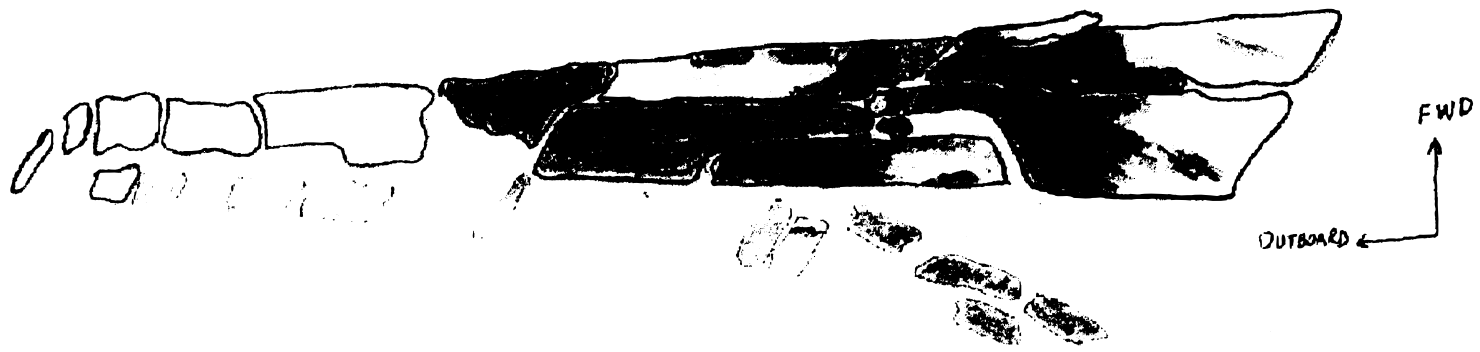

LEFT WING SOOTING PATTERN DIAGRAM

UPPER SKIN - INTERNAL SURFACE

NOTE: Many small pieces of the upper skin are not shown on the diagram.



NOTE: With the exception of the piece noted, the internal surface of the upper skin is clean. The control surfaces do show sooting and fire damage to the composite parts.

NOTE: SEE vent stringer soot diagram for details of vent stringer sooting.

FRACTURES:

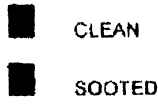

SURFACES:

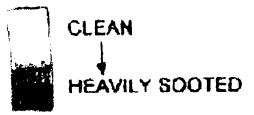

LOWER SKIN - INTERNAL SURFACE

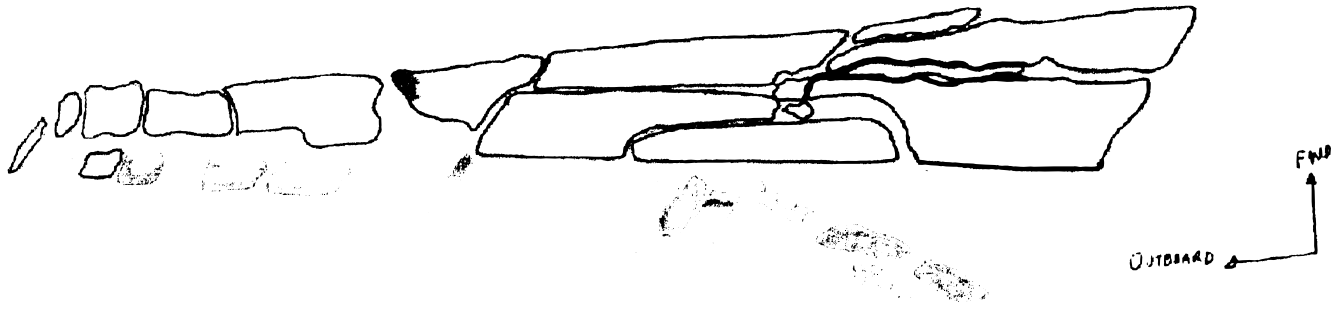

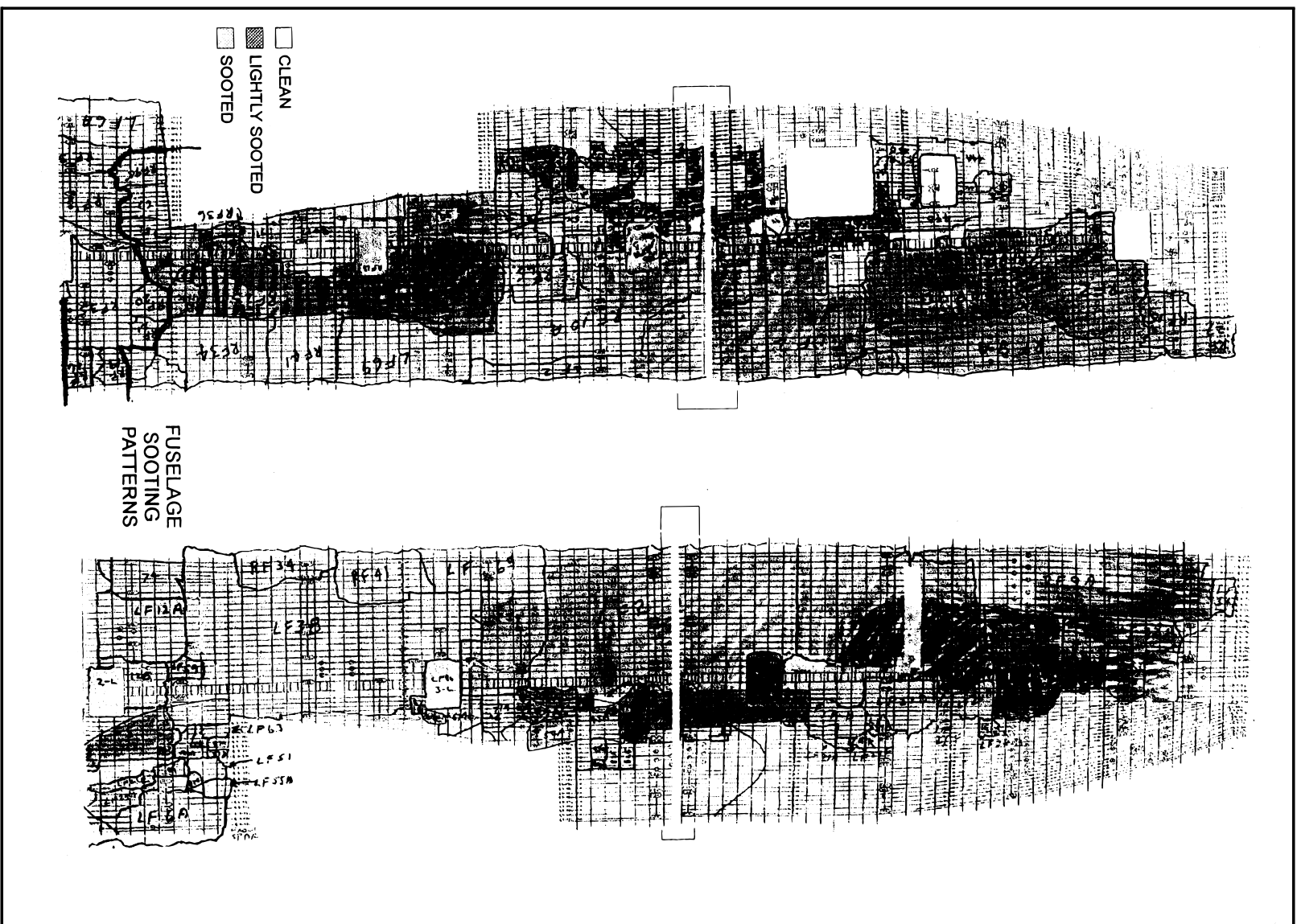

Fuselage sooting diagrams

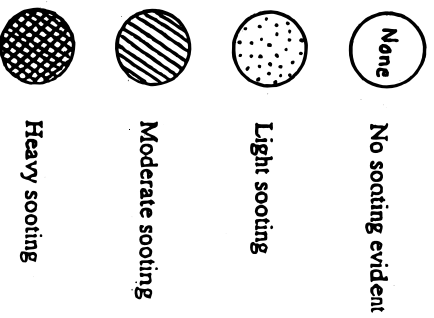

Surveyed panels are all recovered from the Green debris field and are located from approximately STA 910 to STA 1600. Aft of STA 1600, no sooting is evident internally. On the exterior, there is light to moderate sooting extending aft along the entire length of the fuselage from approximately the main deck window belt on the RHS to approximately S-8 on the LHS

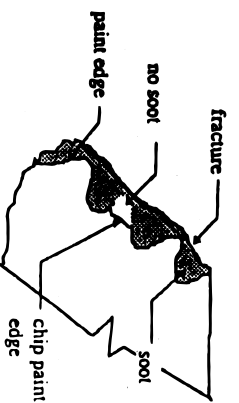
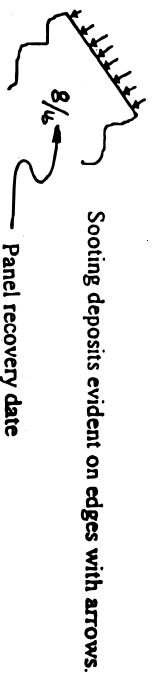

Determination primarily made by examining external paint failures near the fracture edge. Soot deposits remain on underlying paint when the top layer peels near fracture.

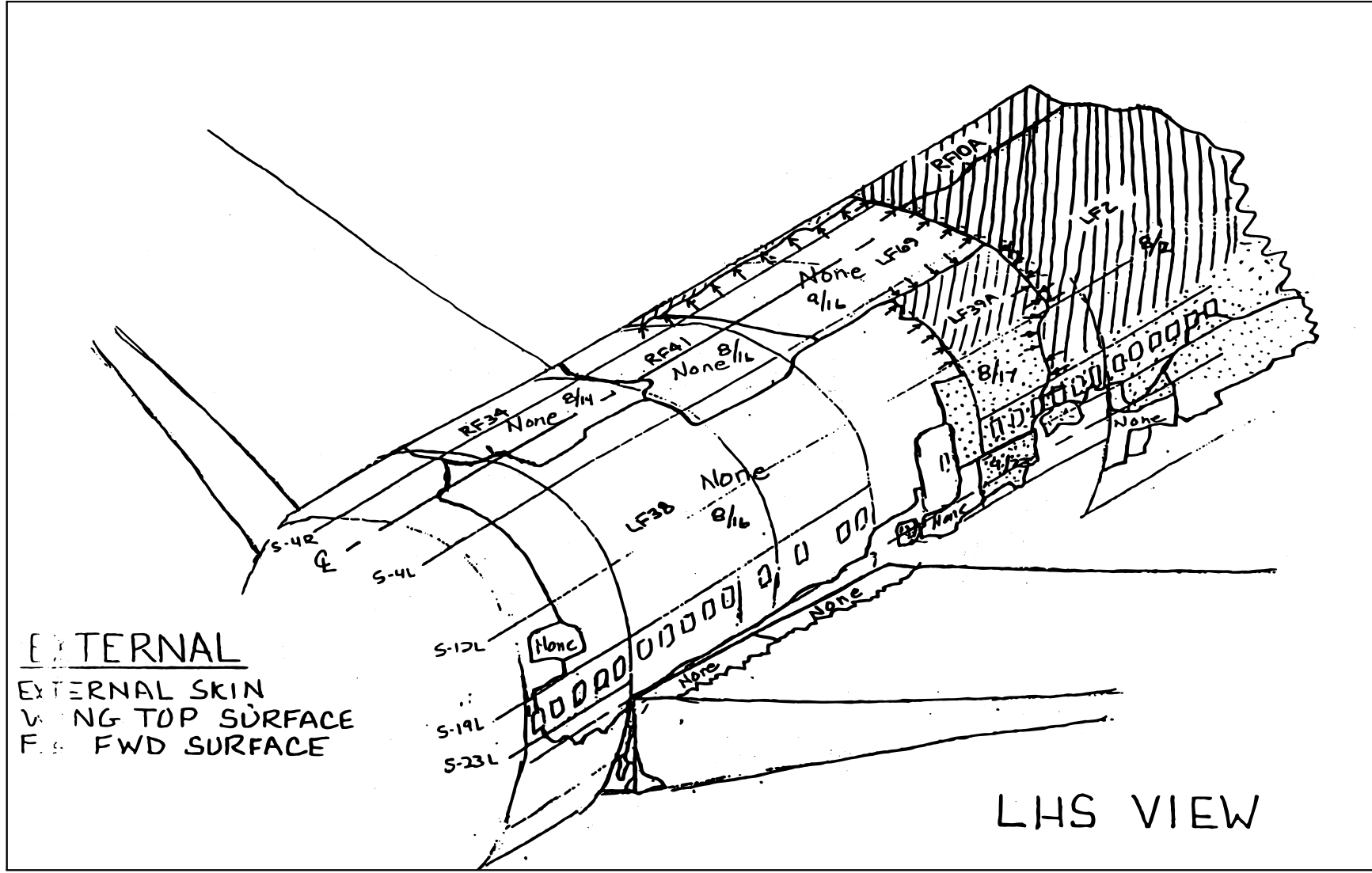

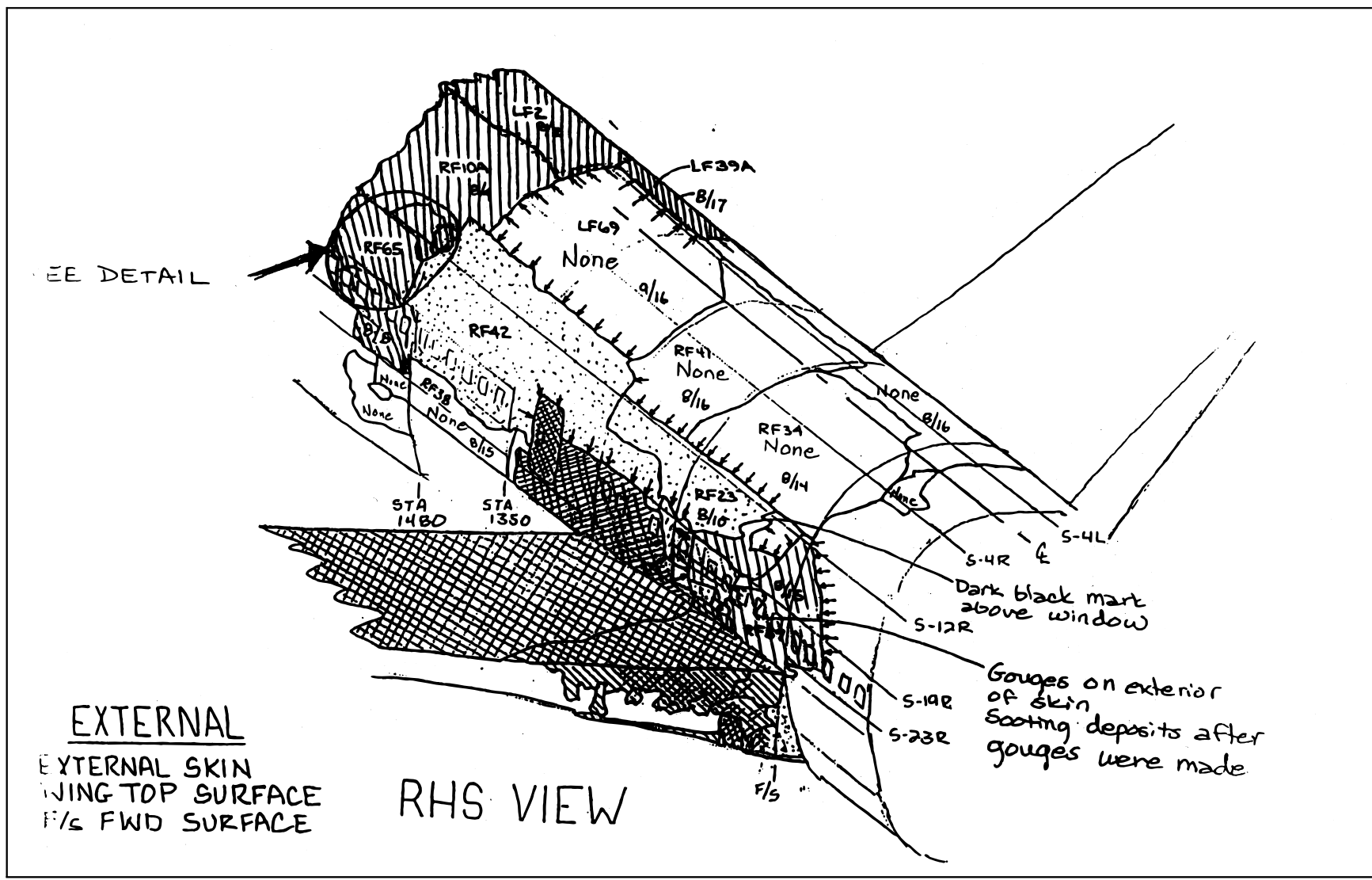

SEE DETAIL

EXTERNAL
EXTERNAL SKIN
WING TOP SURFACE
1/2 FWD SURFACE

RHS VIEW

Dark black mark
above window

Gauges on exterior
of skin
sooting deposits after
gauges were made

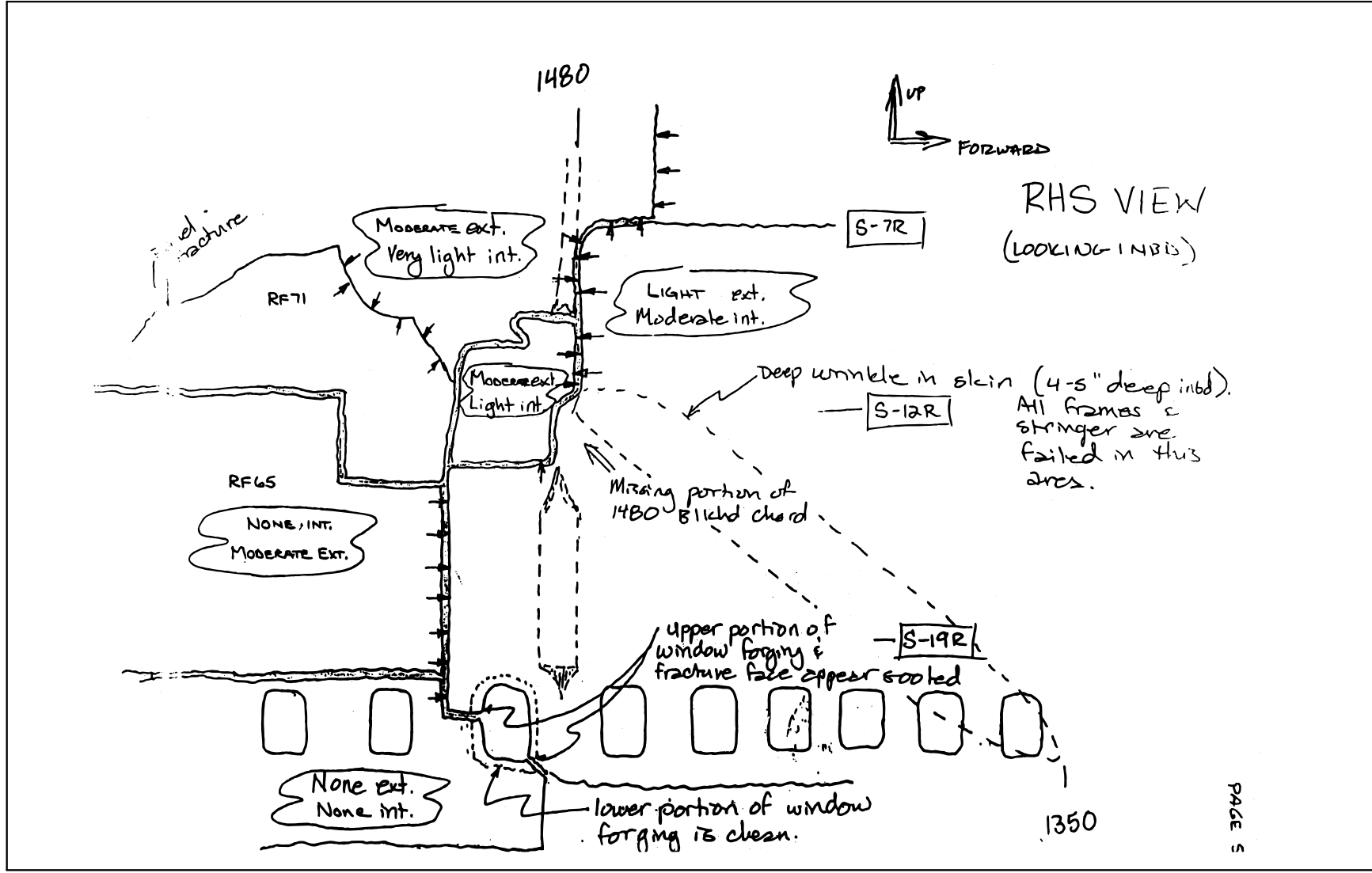

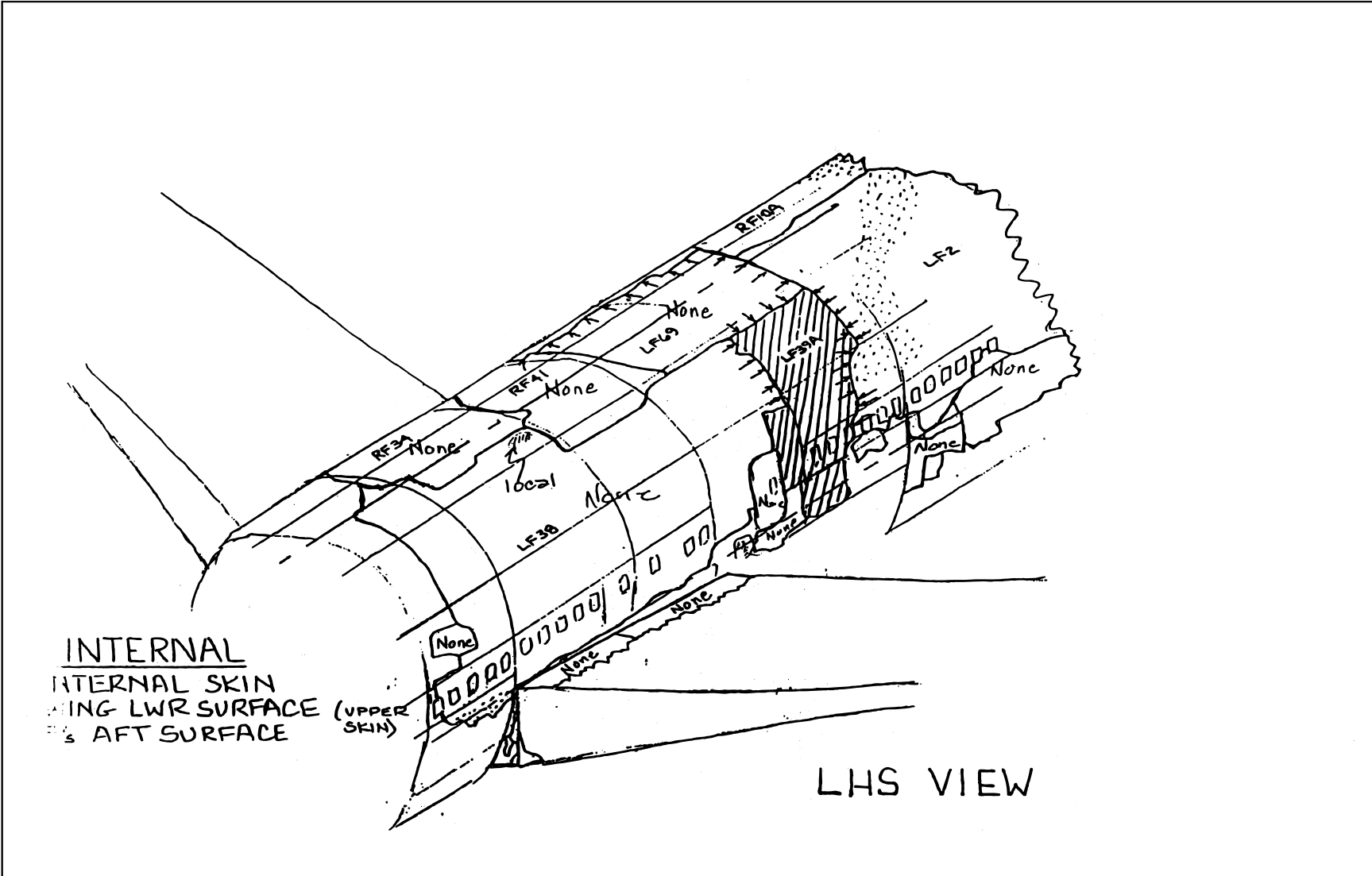

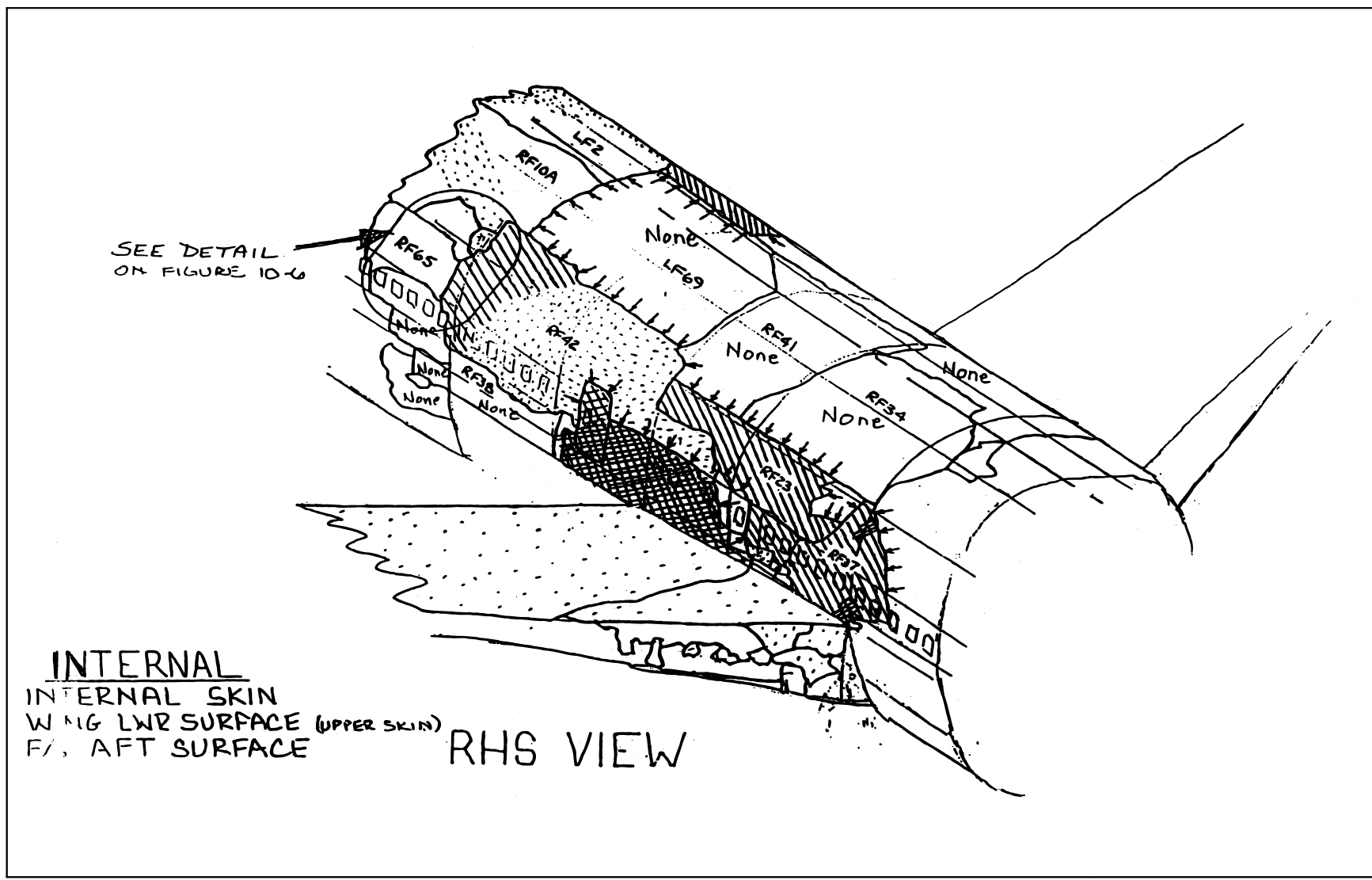

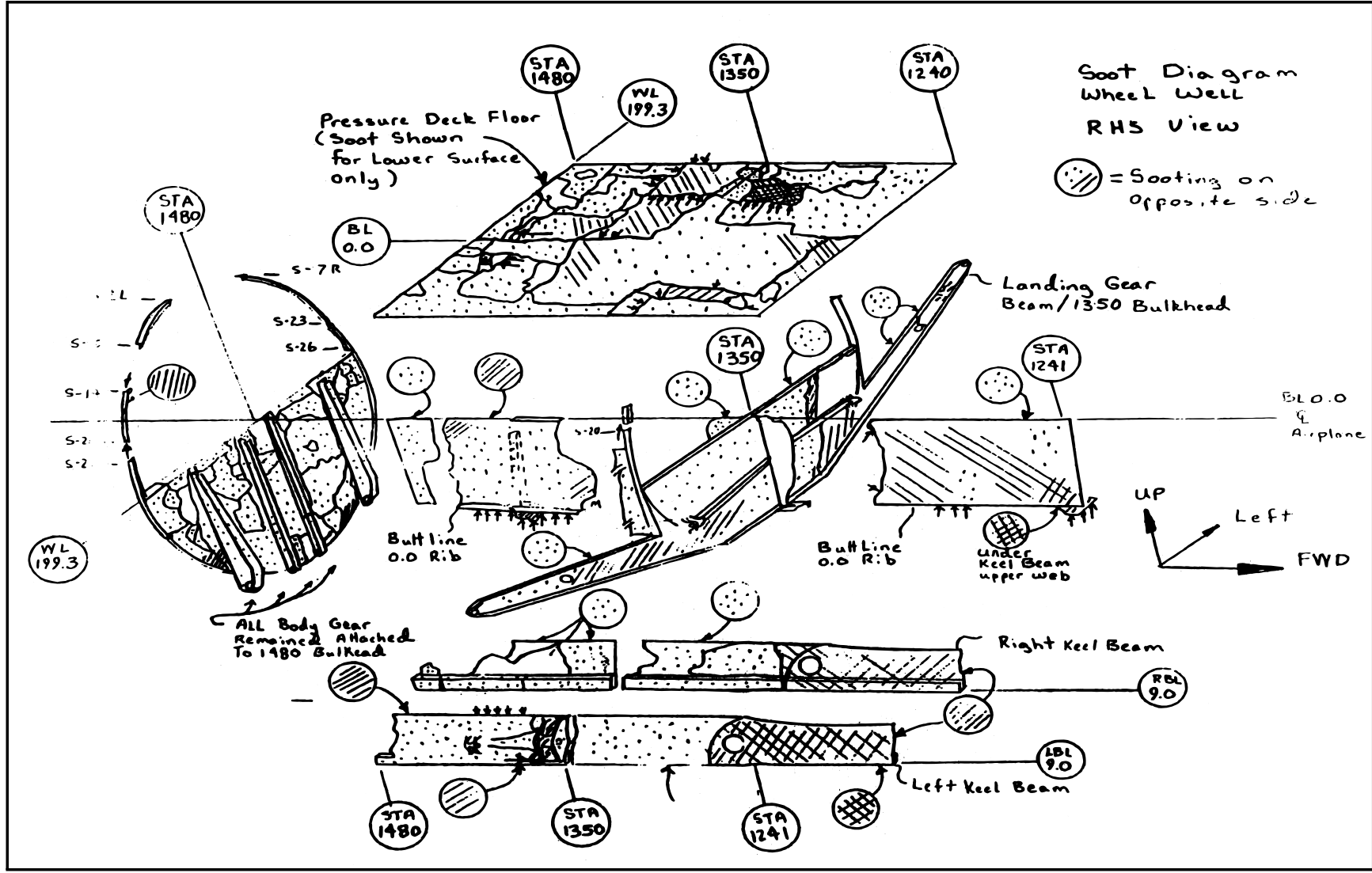

Appendix G

Fuel Tank Explosions/Fires—Civilian and Military Aircraft

**FUEL TANK EXPLOSIONS/FIRES --
CIVILIAN AIRCRAFT**

Model	Operator/ Location	Year	Fatal	Hull loss	Fuel type	Benefit	Phase of operation	Description/Cause
B707	OSO	1959	4	Yes	UNK	Yes	Flight	
B707	Elkton	1963	81	Yes	JP-4	Yes	Flight	Lightning, In flight explosion.
B707	San Francisco	1965	0	Yes	Jet A	Possible	Flight	#4 Engine fire heated wing upper surface above 900°F-- Partially full fuel tank exploded resulting in loss of 21 ft of wing. Landed safely.
B727	Southern Air Tr.	1964	1	No	Jet A	No	Ground maintenance	While purging center tank for entry, static discharge from CO2 Firex Nozzle to center tank access door caused wing tank explosion.
B727	Minneapolis	1968	0	No	Jet A	Yes	Ground refueling	Electrostatic Charge--Ground refueling system found as source of charging-- minor damage to wing structure group. Equipment and airplane refueling system design standards have eliminated recurrence.
B727	Minneapolis	1971	0	No	Jet A	Yes	Ground refueling	See Above.
DC-8	Toronto Canada	1970	106	Yes	JP-4	Yes	Flight	Spoiler deployed. Possible fuel tank explosion during go-around following ground impact during attempted landing.
DC-8	Travis AFB	1974	1	Yes	JP-4	No	Ground	World Airways DC-8 inboard main tank, exploded and burned at Travis AFB during maintenance. Open fuel cell, mechanic forced circuit breaker in.
DC-9	Air Canada	1982	0	Yes	Jet A-1	Possible	Ground maintenance	During maintenance center wing fuel tank exploded. Dry running of pumps suspected cause.

Be 400	Jackson, MS	1989	0	No	JP-4/Jet A	Yes	Ground Refueling	During refueling of auxiliary tank ignition occurred. Tank remained intact but fuel leakage occurred. Electrostatic charge discharge from polyurethane foam source of ignition.
B727	Avionca	1989	107	Yes	Jet A	Possible	Climb	Bomb located over center wing fuel tank. Inerting benefit unknown.
B737	Philippine Airlines	1990	8	Yes	Jet A	Yes	Taxi	Not determined -- empty center wing fuel tank explosion.
B747	TWA 800	1996	230	Yes	Jet A	Yes	Climb	Unknown -- empty center wing fuel tank explosion.

**FUEL TANK EXPLOSIONS/FIRES --
MILITARY AIRCRAFT (NON-COMBAT)**

Model	Operator/ location	Year	Fatal	loss	Hull type	Fuel Benefit	Phase of operation	Cause
B-52	Loring AFB Maine	1970 July	0	Yes	JP-4	Yes	Maintenance	Most likely ignition source traced to arcing or overheat of fuel pump shaft or fuel quantity probe.
B707	Spain	1971 June	Yes	Yes	JP-4	Yes	Descent, 17K	In-flight explosion of #1 main tank. USAF determined chafing of boost pump wires located in conduits as possible ignition source
B-52H	Minot AFB, ND	1975 Nov	0	Yes	JP-4	Yes	Maintenance	Prior to body tank refueling, exploded after midnight while on ramp. No specific evidence but suspected fuel pump locket rotor ignition source
B747	Iranian Fuel Tanker	1976	7	Yes	JP-4	Yes	Descent 8K	Lightning--wing tank.
KC-135Q	Plattsburg AFB, NY	1980 Feb		Yes	JP-4	Yes	Refueling	Aft body tank, faulty fuel probe found as problem.
B-52G	Robins AFB, GA	1980 Aug	Yes	Yes	JP-4	Yes	Maintenance	While transferring fuel from body tanks to wing tanks the empty mid body tank exploded. Investigation showed electrical arcing occurred in the mid body boost pump due to mis-positioned phase lead wire inside the pump.
KC-135A	Near Chicago	1982 March	Yes	Yes	JP-4	Yes	Descent, 12K	Forward body tank exploded, initial cause listed as VHF antenna.
B-52G	Grand Forks AFB ND	1983 Jan		Yes	JP-4	Yes	Maintenance	While troubleshooting a fuel transfer malfunction, center wing tank exploded due to an electrical fault associated with the EMI filter on a valve.
KC-135A	Altus AFB, OK	1987 Feb	Yes	Yes	JP-4	Yes	Landing roll out	During landing roll out an explosion and fire occurred following copilot transmission on UHF radio. The

									UHF wire run near the right aft wing root in the fuselage was melted due to an electrical fault. Fuel vapors in the area of the aft body tank were ignited
B-52H	Swayer AFB, MI	1988 Dec	Yes	Yes	JP-4	Yes	Touch and go	At 20 feet AGL while landing, the empty aft body tank exploded. Pump operating in the aft body tank was cause. Evidence of arcing a overheat was found.	
KC-135A	Loring AFB Maine	1989 Sept	Yes	Yes	JP-4	Yes	Parked	During system flight shut down, explosion in the aft fuselage tank occurred. Source of ignition was believed to be a hydraulically driven fuel pump mounted inside the aft body fuel tank.	
KC-135A	Loring AFB Maine	1989 Oct	Yes	Yes	JP-4	Yes	In flight	Explosion in the pattern aft body fuel tank caused hull loss. Aft body hydraulically driven fuel pump implicated as source of ignition.	
KC-135R	Mitchell Field	1993 Dec	Yes	Yes	JP-4	Yes	Maintenance	During maintenance center wing tank exploded. Center wing fuel tank fuel pump implicated as source of ignition.	

Mitchell Field, Milwaukee, WI