

NTSB-AAR 90/03

PB90-910403  
NTSB/AAR-90/03

# NATIONAL TRANSPORTATION SAFETY BOARD



## AIRCRAFT ACCIDENT REPORT

USAIR, INC., BOEING 737-400  
LAGUARDIA AIRPORT  
FLUSHING, NEW YORK  
SEPTEMBER 20, 1989

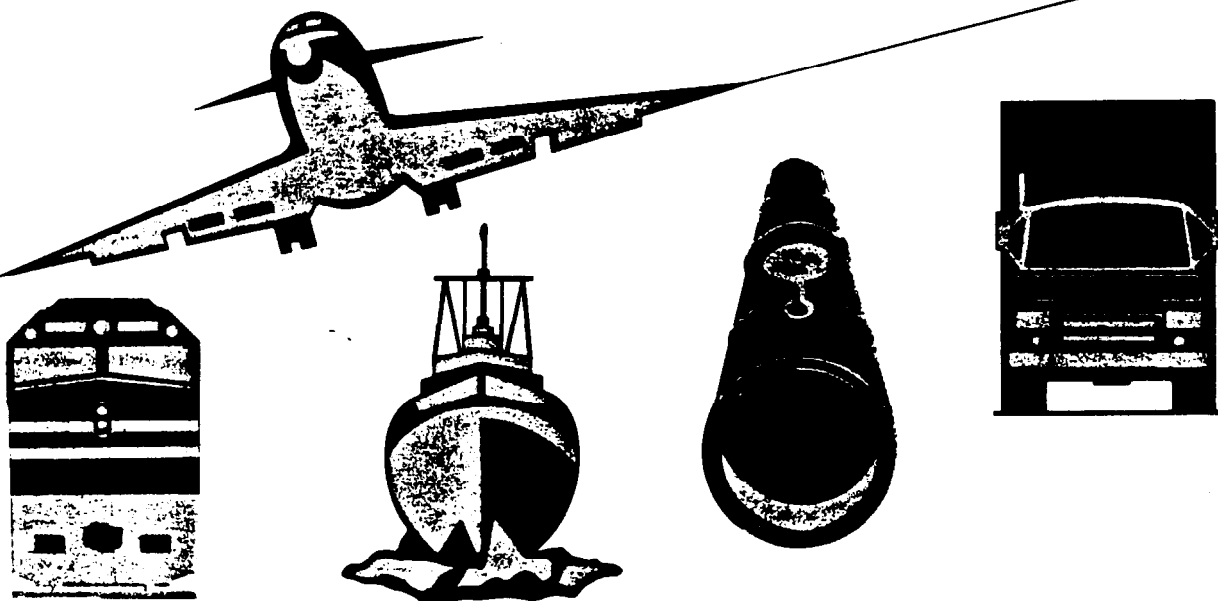

Doc  
NTSB  
AAR  
90/03

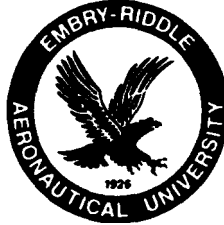

**JACK R. HUNT MEMORIAL LIBRARY**  
DAYTONA BEACH, FLORIDA 32114 . 904-239-6595

---

The National Transportation Safety Board is an independent Federal agency dedicated to promoting aviation, railroad, highway, marine, pipeline, and hazardous materials safety. Established in 1967, the agency is mandated by the Independent Safety Board Act of 1974 to investigate transportation accidents, determine the probable cause of accidents, issue safety recommendations, study transportation safety issues, and evaluate the safety effectiveness of government agencies involved in transportation.

The Safety Board makes public its actions and decisions through accident reports, safety studies, special investigation reports, safety recommendations, and statistical reviews. Copies of these documents may be purchased from the National Technical Information Service, 5285 Port Royal Road, Springfield, Virginia 22161. Details on available publications may be obtained by contacting:

**National Transportation Safety Board**  
Public Inquiries Section, RE-52  
800 Independence Avenue, S.W.  
Washington, D.C. 20594  
**(202)382-6735**



**TECHNICAL REPORT DOCUMENTATION PAGE**

1. Report No. NTSB/AAR-90/03		2. Government Accession No. PB90-910403		3. Recipient's Catalog No.	
4. Title and Subtitle Aircraft Accident Report-- USAir, Inc., Boeing 737-400, LaGuardia Airport, Flushing, New York, September 20, 1989				5. Report Date July 3, 1990	
				6. Performing Organization Code	
7. Author(s)				8. Performing Organization Report No.	
9. Performing Organization Name and Address  National Transportation Safety Board Office of Aviation Safety Washington, D.C. 20594				10. Work Unit No. 5204A	
				11. Contract or Grant No.	
12. Sponsoring Agency Name and Address  NATIONAL TRANSPORTATION SAFETY BOARD Washington, D.C. 20594				13. Type of Report and Period Covered Aircraft Accident Report September 20, 1989	
				14. Sponsoring Agency Code	
15. Supplementary Notes					
16. Abstract This report explains the crash of USAir flight 5050 on September 20, 1989 at New York City's LaGuardia Airport. The safety issues discussed in the report are the design and location of the rudder trim control on the Boeing 737-400, air crew coordination and communication during takeoffs, crew pairing, and crash survivability. Safety Recommendations addressing these issues were made to the Federal Aviation Administration and the Port Authority of New York and New Jersey					
17. Key Words  <i>Rudder control . Crew coordination Pilot decision making Pre flight planning/inspection</i>				18. Distribution Statement This document is available to the public through the National Technical Information Service, Springfield, Virginia 22161	
19. Security Classification (of this report) UNCLASSIFIED		20. Security Classification (of this page) UNCLASSIFIED		21. No. of Pages 98	22. Price



## CONTENTS

	EXECUTIVE SUMMARY .....	v
1.	FACTUAL INFORMATION	
1.1	History of the Flight .....	1
1.2	Injuries to Persons .....	4
1.3	Damage to the Airplane .....	4
1.4	Other Damage .....	4
1.5	Personnel Information .....	4
1.5.1	General .....	4
1.5.2	The Captain .....	4
1.5.3	The First Officer .....	5
1.6	Airplane Information .....	6
1.7	Meteorological Information .....	6
1.7.1	Surface Observations .....	6
1.7.2	Rainfall .....	7
1.8	Aids to Navigation .....	7
1.9	Communications .....	7
1.10	Aerodrome Information .....	7
1.11	Flight Recorders .....	10
1.11.1	The Cockpit Voice Recorder .....	10
1.11.2	The Flight Data Recorder .....	10
1.12	Wreckage and Impact Information .....	13
1.12.1	Main Wreckage .....	13
1.12.2	Marks on the Runway .....	13
1.13	Medical and Pathological Information .....	16
1.14	Fire .....	16
1.15	Survival Aspects .....	17
1.15.1	Seat Damage .....	17
1.15.2	Emergency Exit Damage .....	17
1.15.3	Evacuation .....	17
1.15.4	Emergency Response .....	19
1.16	Tests and Research .....	20
1.16.1	Powerplant Examination .....	20
1.16.2	Rudder Trim Examination .....	20
1.16.3	Brake and Anti-skid Examination .....	21
1.16.4	Simulation Studies .....	22
1.17	Other Information .....	23
1.17.1	Aircraft Systems Descriptions .....	23
1.17.1.1	The Nosewheel Steering System .....	23
1.17.1.2	The Rudder Trim System .....	23
1.17.1.3	The Autothrottle System .....	25
1.17.1.4	The Autobrake System .....	25
1.17.2	<b>USAir B-737-300/400 Pilots Handbook Excerpts</b> .....	25
1.17.3	FAA Oversight of <b>USAir</b> .....	26
1.17.4	Airplane Performance .....	27
1.17.5	Inadvertent Rudder Trim Anomalies .....	28
1.17.6	Corrective Actions .....	29
1.17.7	FAA Drug and Alcohol Post-accident Testing Requirements .....	30
1.17.8	Public Hearing Testimony on Accident-Related Subjects .....	31

1. 17. 9	Pilot Experience and Pairing .....	31
1. 17. 10	Rejected Takeoff Special Investigation .....	<b>32</b>
1. 17. 11	Runway Safety Areas .....	<b>33</b>
1. 17. 12	Overwater Emergency Equipment .....	35
<b>2.</b>	<b>ANALYSIS</b>	
<b>2.1</b>	General .....	38
<b>2.2</b>	Activation of the Rudder Trim .....	<b>38</b>
<b>2.3</b>	Crew Failure to Detect the Mistrimmed Rudder .....	<b>39</b>
<b>2.4</b>	Rudder Trim Control Design .....	<b>41</b>
2. 5	Directional Control Difficulty .....	<b>41</b>
<b>2.6</b>	The RTO Decision .....	43
<b>2.7</b>	Braking Performance .....	<b>44</b>
<b>2.8</b>	Engine Performance .....	<b>46</b>
<b>2.9</b>	The "Bang" and Rumble on the CVR .....	<b>47</b>
<b>2.10</b>	Crew Coordination During the Takeoff Run .....	<b>47</b>
2. 10. 1	Cockpit Resource Management Training .....	47
2. 10. 2	Pre-takeoff Emergency Procedures Briefings .....	<b>49</b>
2. 10. 3	Crew Coordination During the Takeoff Run .....	<b>49</b>
2. 10. 4	Pilot Experience and Pairing .....	50
2. 11	Making Runway Overruns Safer .....	51
2. 12	Survival Factors .....	52
2. 13	Postaccident Toxicological Testing .....	<b>54</b>
2. 14	Postaccident Aircrew Availability .....	<b>54</b>
<b>3.</b>	<b>CONCLUSIONS</b>	
<b>3.1</b>	Findings .....	55
<b>3.2</b>	Probable Cause .....	57
4.	RECOMMENDATIONS .....	58
5.	APPENDICES	
	Appendix A-- Investigation and Hearing .....	<b>61</b>
	Appendix B-- Personnel Information .....	<b>62</b>
	Appendix C-- Airplane Information .....	63
	Appendix D-- Cockpit Voice Recorder Transcript .....	64
	Appendix E-- Synopsis of Fire and Rescue Critiques and Post- Accident Improvements .....	94

## EXECUTIVE SUMMARY

On September 20, 1989, USAir, Inc. flight 5050 was departing New York City's LaGuardia Airport, Flushing, New York, for Charlotte Douglas International Airport, Charlotte, North Carolina. As the first officer began the takeoff on runway 31, he felt the airplane drift left. The captain noticed the left drift also and used the nosewheel tiller to help steer. As the takeoff run progressed, the aircrew heard a "bang" and a continual rumbling noise. The captain then took over and rejected the takeoff but did not stop the airplane before running off the end of the runway into Bowery Bay. Instrument flight conditions prevailed at the time and the runway was wet.

The National Transportation Safety Board determines that the probable cause of this accident was the captain's failure to exercise his command authority in a timely manner to reject the takeoff or take sufficient control to continue the takeoff, which was initiated with a mistrimmed rudder. Also causal was the captain's failure to detect the mistrimmed rudder before the takeoff was attempted.

The safety issues discussed in this report were the design and location of the rudder trim control on the Boeing 737-400, air crew coordination and communication during takeoffs, crew pairing, and crash survivability.



NATIONAL TRANSPORTATION SAFETY BOARD  
WASHINGTON, D. C. 20594

AIRCRAFT ACCIDENT REPORT

**USAIR, INC.**  
BOEING 737-400  
LAGUARDIA AIRPORT  
FLUSHING, NEW YORK  
SEPTEMBER 20, 1989

1. FACTUAL INFORMATION

1.1 History of the Flight

On September 20, 1989, **USAir** flight 5050 was an "extra section" passenger flight to replace the regularly scheduled but cancelled flight 1846 from New York City's **LaGuardia** Airport (LGA), Flushing, New York, to Charlotte Douglas International Airport (CLT), Charlotte, North Carolina. As the first officer began the takeoff on runway 31 the airplane drifted to the left, and the captain used the nosewheel steering tiller to correct the drift. Later in the takeoff run, the flightcrew heard a "bang" and a rumbling noise. The captain then took over control from the first officer and rejected the takeoff. The airplane did not stop before running off the end of the runway into Bowery Bay. Instrument conditions prevailed, and the runway was wet. The flight was operating under Title 14, Code of Federal Regulations Part 121.

About 1400 hours eastern daylight time on September 20, the captain and first officer reported to **USAir** operations at Baltimore-Washington International Airport (BWI) to fly the Boeing 737-400 (B-737) **N416US** to LGA as **USAir** flight 1846. Scheduled departure from BWI was 1510, but air traffic inbound to LGA delayed the takeoff until 1935. Holding on the **taxiway** at BWI for 1.5 hours required the flight to return to the terminal area for fuel. Flight 1846 left BWI uneventfully and arrived at **LGA's** Gate 15 at 2040.

Weather and air traffic in the LGA terminal area had caused cancellations and delayed most flights for several hours. According to all airline personnel interviewed, delays that long are unusual and occur only a few times a year at LaGuardia. While on the ground at LGA, the captain went to **USAir** operations and then returned to the aircraft expecting to fly to Norfolk, Virginia. However, the **USAir** dispatcher decided to cancel the Norfolk leg, unload the passengers, and send the flight to CLT without passengers. Several minutes later, the dispatcher told ~~the~~ captain that his airplane would not be flown empty but would carry passengers to Charlotte as **USAir** flight 5050. This seemed to upset the captain, according to the passenger service representative, who said that the captain expressed concern for the passengers because more delays would cause him and the first officer to exceed crew duty time limitations before the end of the trip. While passengers were boarding, the captain visited **USAir's** ground movement control tower to ask about how decisions were made about flights and passengers.

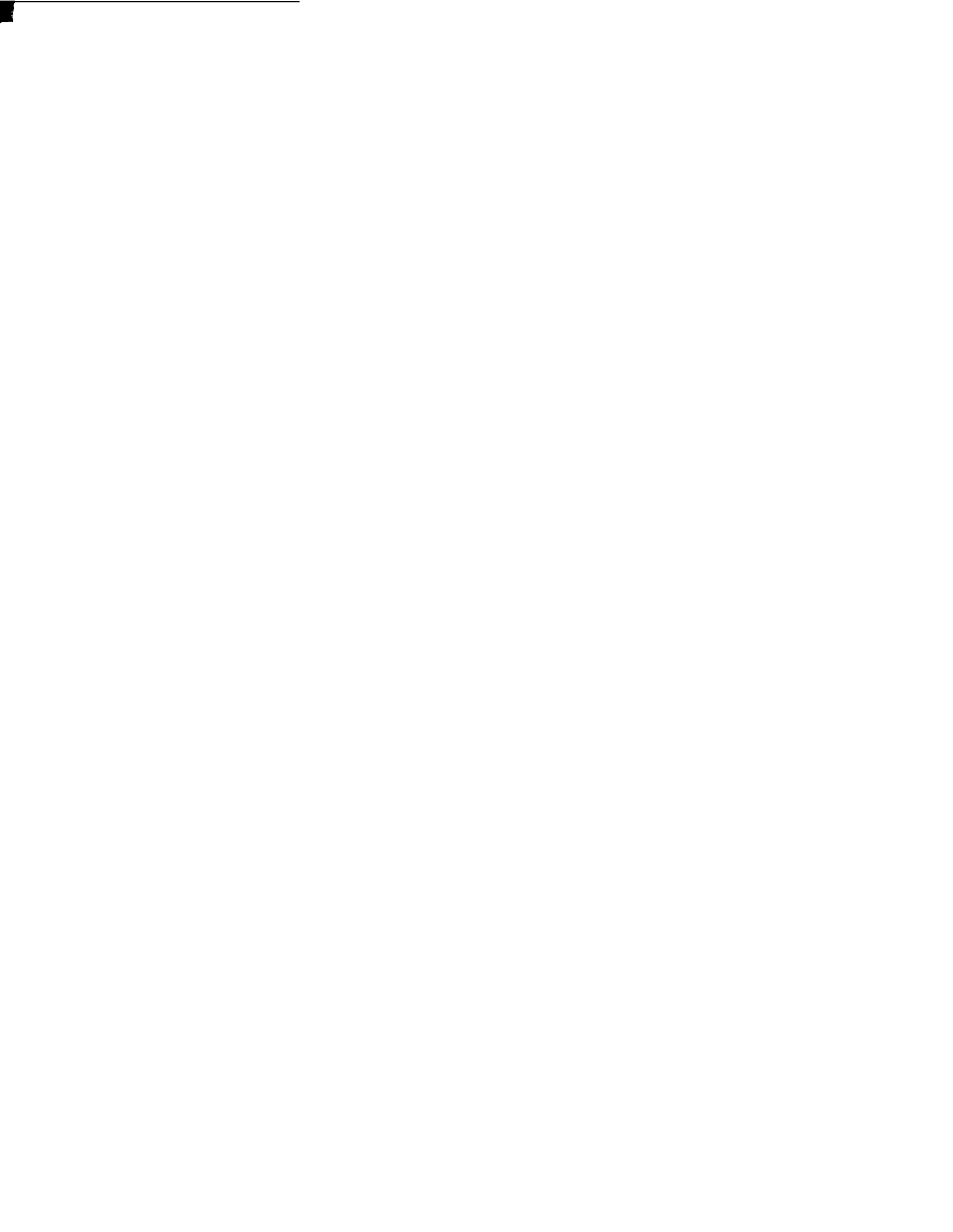

During the captain's absence, the first officer stayed in the cockpit. He said later that, while he was in his cockpit seat, he placed new pages for an **enroute** chart/approach plate holder on the center pedestal then put the pages into the holder on his lap. Meanwhile, a captain from Pan American World Airways, who was flying as a non-revenue passenger, entered the cockpit and sat down facing crosswise on the auxiliary jump seat behind the captain's seat. This captain said another person from **USAir** entered the cockpit and gave the crew a single-sheet weather chart that was eventually placed on the center pedestal. Several other persons were also in the cockpit at various times before departure.

The captain returned to the cockpit as the last of the passengers were boarding, and the entry door was closed. After the **jetway** was retracted, the passenger service representative told the captain through the open cockpit window that he wanted to open the door again to board more passengers. The captain refused, and flight 5050 left Gate 15 at 2252.

During the initial interview with the Safety Board, the flight crew described starting the engines and taxiing out to runway 31 as uneventful. They said six to eight airplanes were ahead of them on the **taxiway** awaiting takeoff clearance. Two minutes after push-back, the ground controller told the crew to hold short of **taxiway GOLF GOLF**. However, the captain failed to hold short of that **taxiway** and received modified taxi instructions from the ground controller at 2256. The captain then briefed takeoff speeds as  $V_1$ : 125 knots,  $VR$ : 128 knots, and  $V$ : 139 knots. The captain had flown the BWI-LGA segment, and the first officer was to be the flying pilot on the LGA-CLT segment. No company or Federal regulations govern flying pilot choices. As the flying pilot, the first officer's departure briefing consisted of his reciting to the captain his turn and altitude clearance and the **LaGuardia 3** departure clearance.

About 2 minutes later, the first officer announced "stabilizer and trim" as part of the before-takeoff checklist. The captain responded with "set" and then corrected himself by saying: "Stabilizer trim, I forgot the answer. Set for takeoff." According to **USAir's B-737-300/400** normal procedures checklist, "set for takeoff" was the correct response, although the captain's words "stabilizer trim" failed to restate the correct challenge. The captain said during the public hearing that he had no specific recollection of checking trim settings on the accident flight but that his normal procedure would be to do so. The first officer said during the hearing that he did not check the trim settings himself while he was running the checklist during taxi-out. **USAir** procedures did not require him to do so.

The last item on the before-takeoff checklist was **AUTO-BRAKE**. When challenged on this item, the captain responded "is off," and the first officer called the checklist complete.

Flight 5050 was cleared into position to hold at the end of the runway at **2318:26** and received takeoff clearance at **2320:05**. The cockpit voice recorder (CVR) disclosed the sound of increasing engine noise, and shortly thereafter the first officer pressed the autothrottle disengage

button instead of the takeoff/go-around (TO/GA) button. He later said that he then pressed the TO/GA button, but noted no throttle movement. He then advanced the throttles manually to a "rough" takeoff-power setting. The captain then said: "Okay, that's the wrong button pushed" and 9 seconds later said: "All right, I'll set your power." The captain later said he thought he had rearmed and reengaged the autothrottles and had advanced the throttles to the N1 target setting of 95 percent while depressing the TO/GA button. The first officer later explained that "I'll set your power" meant to him that the captain was "fine-tuning" the setting to takeoff power. Both crewmembers agreed that the airplane then began tracking to the left during the takeoff roll. About 18 seconds after beginning the roll, the CVR recorded a "bang" followed shortly by a loud rumble. The captain later said that during this time the airplane continued tracking to the left and that he was becoming concerned about the unidentified bang and rumble. The first officer later said he believed he had stopped the leftward tracking and the airplane "began to parallel the runway centerline."

At **2320:53**, the CVR recorded the captain saying "got the steering." The captain later testified that he had said, "You've got the steering." The first officer testified that he thought the captain had said: "I've got the steering." When the first officer heard the captain, he said "Watch it then" and began releasing force on the right rudder pedal but kept his hands on the yoke in anticipation of the VI and rotation callouts.

At **2320:58.1**, the captain said: "Let's take it back then" which he later testified meant that he was aborting the takeoff. According to the captain, he rejected the takeoff because of the continuing left drift and the rumbling noise; he said that he used differential braking and nose wheel steering to return toward the centerline and stop. The sound of throttle levers hitting their idle stops was recorded at **2320:58.4**. According to data from the digital flight data recorder (DFDR), indicated airspeed at that time was 130 knots. The sound of engine noise decreasing was recorded at **2321:00.9**. The first officer then told the tower about the rejected takeoff. In later testimony, the first officer said that he was unaware of the reason for the captain's decision to abort.

Increasing engine sound indicating employment of reverse thrust was heard on the CVR almost 9 seconds after the abort maneuver began. The airplane did not stop on the runway but crossed the end of the runway at 34 knots ground speed. It came to rest in the water supported by the pier that holds runway 13's approach lights. The sound of impact was recorded at **2321:21.9**.

Both pilots agreed that the farthest the airplane tracked to the left during the rejected takeoff (RTO) was about halfway between the centerline and the left side of the runway; both said that during the RTO they thought the airplane could be stopped on the remaining runway. Neither pilot could recall noting the airspeed at initiation of the RTO, and the CVR recorded no standard airspeed callouts.

The accident occurred in darkness at 40°56'36" north, 73°52'24" west. Both pilots and the four cabin crewmembers had minor injuries. Two of the 57 passengers were killed and 15 were injured. Passengers included a 5-year-old child and an 8-month-old baby held by its mother. Neither the infant nor the child was injured.

## 1.2 Injuries to Persons

<u>Injuries</u>	<u>Crew</u>	<u>Passengers</u>	<u>Others</u>	<u>Total</u>
Fatal	0	2	0	2
Serious	0	3	0	3
Minor	6	12	0	18
None	0	37	0	37
Unknown*	0	3	0	3
Total	6	57	0	63

\*Hospital records were not available for three passengers.

## 1.3 Damage to the Aircraft

The airplane was destroyed. The insurance agent handling the claim said that the hull loss of a Boeing 737-400 in this configuration was **\$35,000,000**.

## 1.4 Other Damage

The cost of replacing the pier and approach lighting destroyed during the accident was \$150,000, according to the Port Authority of New York and New Jersey.

## 1.5 Personnel Information

### 1.5.1 General

Piedmont Airlines originally hired both pilots, but **USAir** trained them using a "mirror image" transition training concept in anticipation of a corporate merger, which occurred on August 5, 1989. This concept was to make Piedmont flight training and flight operations identical to that of **USAir** by the time of the merger.

### 1.5.2 The Captain

The captain, 36, held Airline Transport Pilot certificate 24378065 with endorsements for the **deHavilland** DH-4 and the B-737. He also had multiengine commercial and single engine land ratings, along with a turbojet flight engineer certificate. The Federal Aviation Administration (FAA) issued him a first class medical certificate with no limitations on May 17, 1989.

The captain received his initial flight training in the United States Air Force (USAF) in 1979. His first military line flying assignment was in USAF Reserve Lockheed C-130 transport airplanes. In 1987, he upgraded to aircraft commander in the C-130 and held the rank of Major at the time of the USAir accident. He failed his first C-130 aircraft commander check ride in part because of poor checklist usage.

Piedmont Airlines hired the captain on July 9, 1984, and he satisfactorily completed B-727 flight engineer ground school on July 13, 1984, and served as a B-727 flight engineer until August 1985. He completed B-737-200 ground school on August 9, 1985, and B-737-200 flight training on August 27, 1985, with 34 simulator hours and 1.7 hours in the aircraft. He completed B-737-300 differences flight training as a first officer on September 19, 1986, and B-737-400 differences ground training on May 19, 1989. He said that he believed he had "between 5 and 10" RTO's in the B-737 simulator, all after simulated engine anomalies. He had experienced one low-speed RTO in the B-737 after a takeoff warning system alarm had sounded.

The captain began his B-737-300/400 training as a captain candidate in June 1989 and completed initial qualification ground school on June 28, 1989. He completed flight training in the B-737-300 with 22 flight hours plus 4 hours of line oriented flight training (LOFT) in a simulator on July 9, 1989. His initial operating experience in the B-737-300/400 consisted of 14 hours with 11 takeoffs and landings followed by a 9.2-hour FAA-observed line check with 6 takeoffs and landings completed on July 20, 1989. His captain's training was interrupted twice, once by a USAF Reserve deployment and once by minor illness.

Supervisory USAir pilots generally described the captain's performance during upgrade training as "average." The pilot who supervised the captain's initial operating experience said the captain had no problems making decisions. The captain had no formal training in cockpit resource management.

The captain had total estimated flying time of 5525 hours, 1500 hours of which were in the USAF and USAF Reserve. Ninety-seven of the military hours were in command of the C-130. He accumulated about 2625 hours in all models of the Boeing 737. His 30, 60 and 90 day flying hour totals at USAir were 23, 72 and 121.5 hours, respectively, all in B-737-300/400 aircraft as captain. His total flying time as a B-737-400 captain was about 140 hours. His last B-737 flight prior to September 20th was on September 3rd, the last leg of a three-day trip. He flew the C-130 on September 8th for 0.3 hours and again on September 18th for 2.0 hours. During the 24 hours preceding the accident, he flew 0.9 hours on the BWI-LGA leg.

### 1.5.3 The First Officer

The first officer, 29, held Airline Transport Pilot certificate 572317704 with commercial multiengine land and single engine land and sea ratings. Piedmont Airlines hired him in May of 1989. He completed B-737 ground school on July 14, 1989, and B-737 first officer flight training on

August 8, 1989, with 24 hours in the simulator and 1.1 flight hours. His initial operating experience consisted of 14.2 flight hours and the observation of 12 landings from the jump seat. He also performed 2 takeoffs and two landings. His line check on August 12, 1989, consisted of 3.1 flight hours and three takeoffs and landings, which was the last time he flew prior to the BWI-LGA flight of September 20, 1989. He had 3,287 flying hours, 8.2 of which were in the B-737-300/400. He had flown 8.3 hours in the previous 90 days and 0.9 hours in the previous 24 hours. The first officer had no formal instruction in cockpit resource management. His prior experience had been attained in small and commuter turboprop-type airplanes.

#### 1.6 Aircraft Information

On December 23, 1988, The Boeing Company delivered to Piedmont Aviation the B-737-400, U. S. registration **N416US**. At the time of the accident, **USAir** owned and operated the aircraft, which was powered by two CFM International CFM-56-32B engines. Registration and airworthiness certificates were valid.

By the accident date, the airplane had 2,235 hours and 1,730 cycles. Its "C" maintenance check was in four phases conducted in intervals of 1,050 operating hours. The last major check was a "C2" on August 3, 1989, at Greensboro, North Carolina, that showed no noteworthy maintenance **discrepancies**.

Maintenance logbooks showed replacement of main landing gear tires at regular intervals because of normal tread wear, which also prompted replacement of the two nose wheels and tires on August 28, 1989. No nose wheel, main landing gear, or main landing gear brake malfunctions were reported within 3 months prior to the accident. Also, the logbooks contained no open write-ups on the date of the accident. The takeoff weight of the airplane was 107,900 pounds, and maximum allowable gross weight was 129,600 pounds. The center of gravity was 18 percent mean **aerodynamic** chord and within limits.

According to the **cockpit** voice recorder, the crew based takeoff speeds on a gross weight of 105,000 pounds. Correct  $V_1$ ,  $V_R$ , and  $V_2$  speeds for this weight were 125 knots, 128 knots, and 139 knots respectively.

#### 1.7 Meteorological Information

##### 1.7.1 Surface Observations

The Weather Service Contract Meteorological Observatory at **LaGuardia** issued the following observation:

Time--2334; type--local; ceiling--estimated 500 feet overcast; visibility--5 miles; weather--light rain and fog; **temperature--73° F.**; dew **point--73° F.**; wind--210 degrees at 4 knots; altimeter--30.20 inches; remarks--aircraft mishap.

The Low-Level Windshear Alert System (LLWAS) located near the departure end of runway 31, showed average wind at the time of the accident from **207°** at 5.4 knots.

#### 1.7.2 Rainfall

On September **20th**, 1.72 inches of rain fell, 0.01 inches between 2100 and 2200, 0.01 inches between 2200 and 2300, and 0.08 between 2300 and 0000.

Interpretation of the recording from a weighing rain gage at LaGuardia showed accumulation of 0.03 inches from 2300 to 2315 and 0.01 inches between 2315 and 2330. Around 2330, 0.02 inches accumulated rapidly, and from 2330 to 2345 a trace of less than 0.01 inch fell.

The cockpit crewmembers said that they did not use the windshield wipers during the rejected takeoff.

#### 1.8 Aids to Navigation

Navigational aids were not a factor.

#### 1.9 Communications

No communications problems were reported between the crew and any air traffic control facility before or during the accident sequence.

#### 1.10 Aerodrome Information

The Port Authority of New York and New Jersey operates LaGuardia Airport under lease from the City of New York.

Runway 31 is 7,000 feet long by 150 feet wide with a **100-foot** overrun at the departure end (figure 1). The surface is asphalt with saw-cut transverse grooves **1 1/2** inches apart and **1/4** inch wide and deep. About the last 900 feet is concrete with similar, but not uniform, transverse grooves averaging **1/8** inch deep. The concrete portion, including a **100-foot** ungrooved and heavily painted overrun before the threshold, is on an elevated deck above Bowery Bay. Runway 31's slope increases from 7 feet msl at the threshold to 13 feet msl at the runway 13 threshold. The surface between **taxiways X and L** received a rubber-removal treatment on September 3, 1989. Runway **4/22** also is 150 feet wide and crosses runway 31 about 1,300 feet from the departure end. Runway 31 has a three-bar visual approach slope indicator (VASI), centerline and edge lighting, and runway end identifier lights.

The National Aeronautics and Space Administration (NASA) tested runway 31's drainage and friction using a self-wetting Saab Friction Tester owned by the Port Authority of New York and New Jersey. Figure 2 is an evaluation of the rejected takeoff in terms of speed, lateral displacement from runway centerline, and the friction coefficient. The report NASA furnished the Safety Board said:



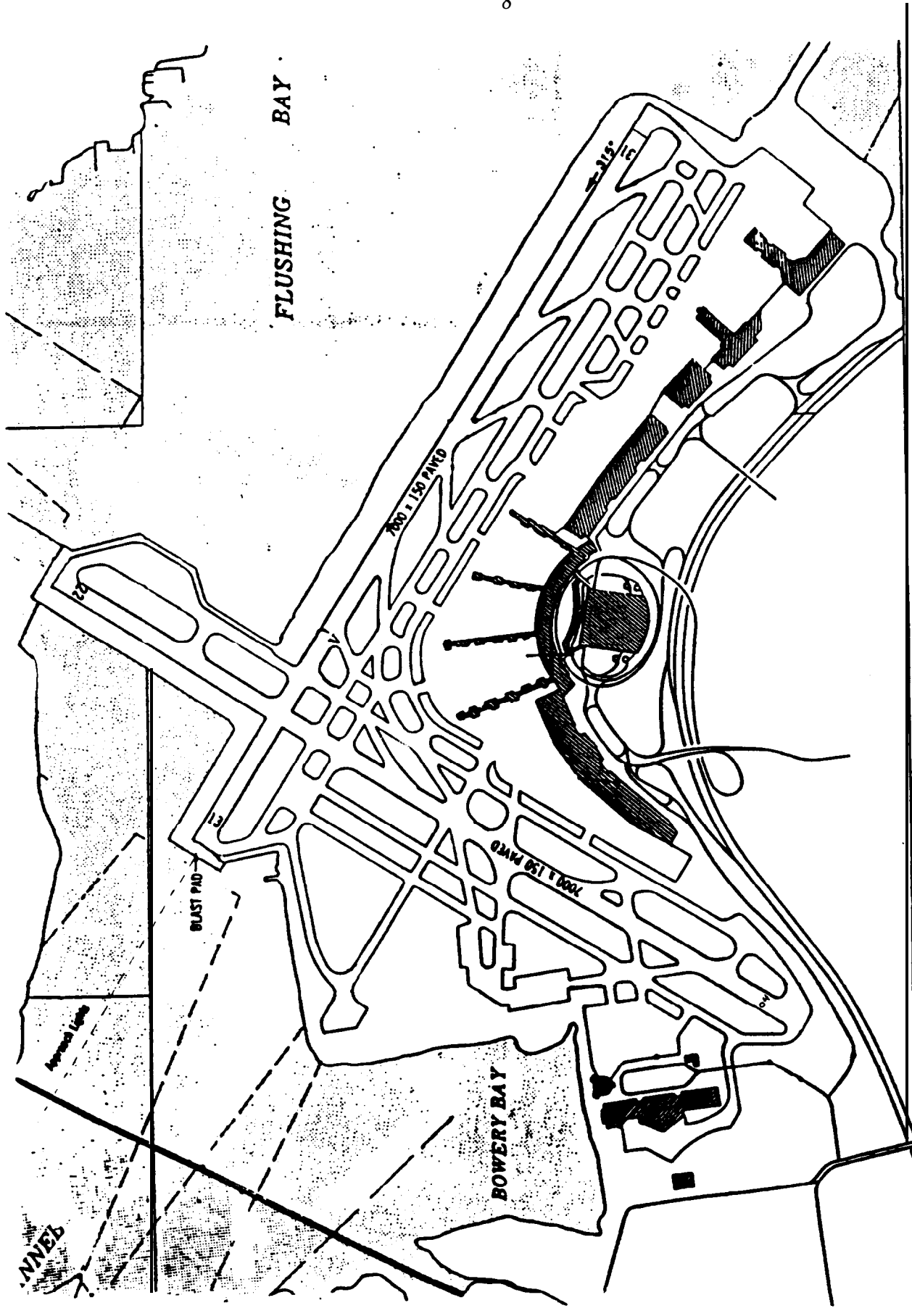

Figure 1.--Airport diagram.

## Rejected Takeoff Braking Levels

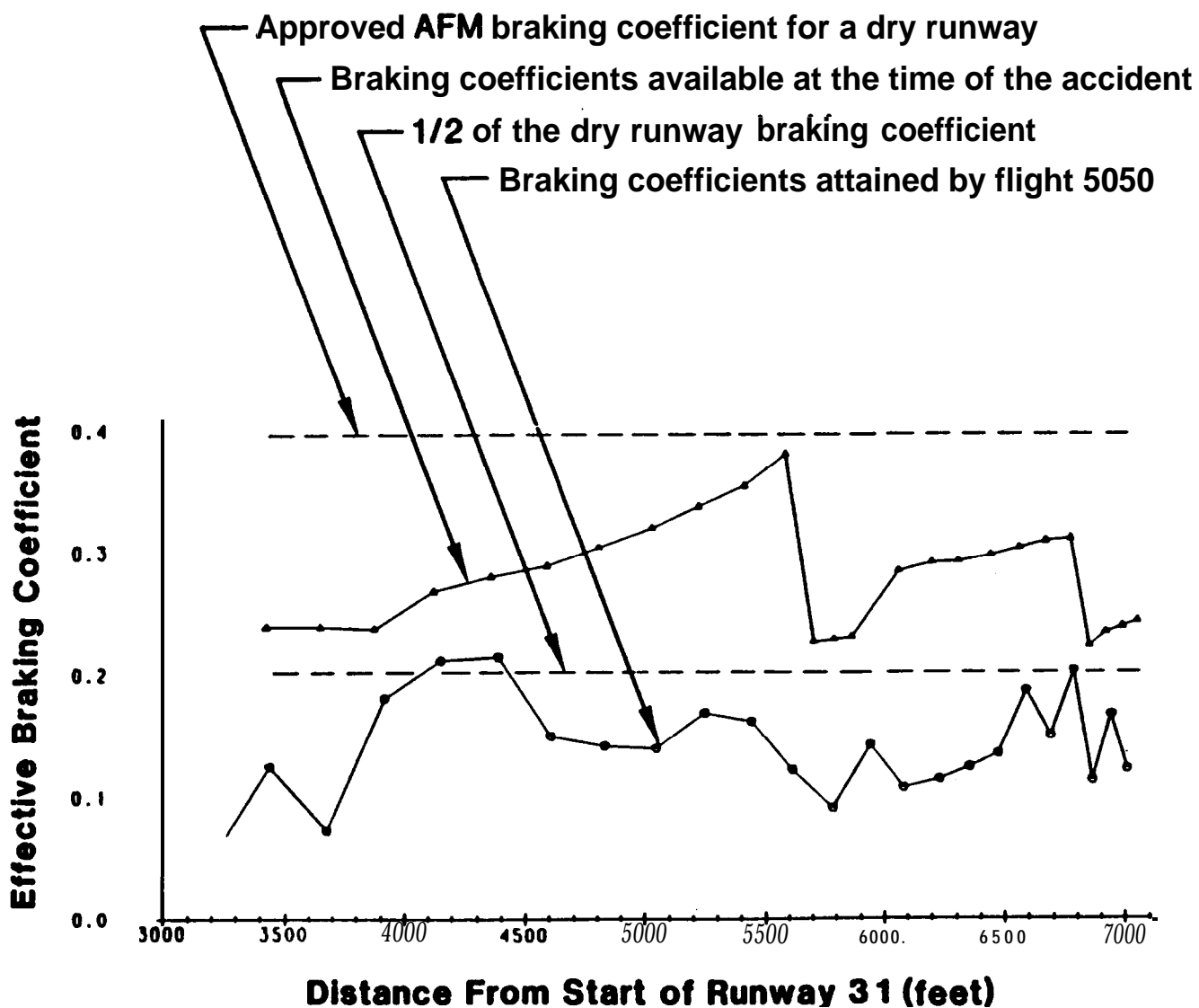

Figure 2. -- NASA Evaluation of B-737-400 aircraft rejected takeoff on runway 31 at LaGuardia Airport on September 20, 1989.

Based on runway surface characteristics, crown, and texture depth values, the drainage analysis indicates that runway 31 had excellent water drainage capability (excluding the painted nongrooved blast pad [overrun] area) particularly for the rainfall rate occurring at the time of the accident (.008 in./hr.). With the transverse grooving, and the good tread condition of the main gear tires, hydroplaning was not a significant factor. Except for approximately 1,200 feet near runway 4/22 intersection, the accident aircraft RT0 track was established by the white tire erasure marks found on both the asphalt and concrete deck surfaces of the runway. In terms of tire friction performance, the Saab friction tester results indicate that the lateral displacement of the aircraft left of centerline actually provided better friction performance compared to that measured closer to runway centerline.

## 1.11 Flight Recorders

### 1.11.1 The Cockpit Voice Recorder

The Fairchild Model A-100 Cockpit Voice Recorder (CVR) survived intact with a recording of excellent quality. The CVR recording started at 2249:30 just as the airplane was pushed back from the terminal at LaGuardia and continued for 31 minutes and 41 seconds until 2321:22.

### 1.11.2 The Flight Data Recorder

The digital flight data recorder (DFDR), a Fairchild Model F800, was also undamaged, and the quality of the data was generally good. Printouts of selected DFDR parameters are in Figure 3. As the engines were shut down at the gate after the flight from BWI to LGA, an oil pressure sensor in the left engine tripped power to the DFDR; the rudder position was recorded at 0° deflection.

After engine start at the gate, the DFDR began recording the accident flight. The airplane's heading was 357.2°, and the rudder was 15.9° left, essentially the position equating to full left rudder trim. Subsequent excursions in rudder position, elevator position, and aileron position were those normally associated with a flight control check. Rudder position returned to 15.9° left following the excursions.

The first indication of the takeoff start was the increasing N1 values for both engines. During the early part of the takeoff, the airplane's heading deviated nearly 2° left of the runway heading, rudder position varied from 0.44° right to 6.9° left, ground speed increased to 91 knots, and N1 values for the left and right engines increased to 91.5 and 94.5 percent, respectively. The airplane's heading was nearly 5° to the left of the runway

# USAir Flight #5050 - Accident

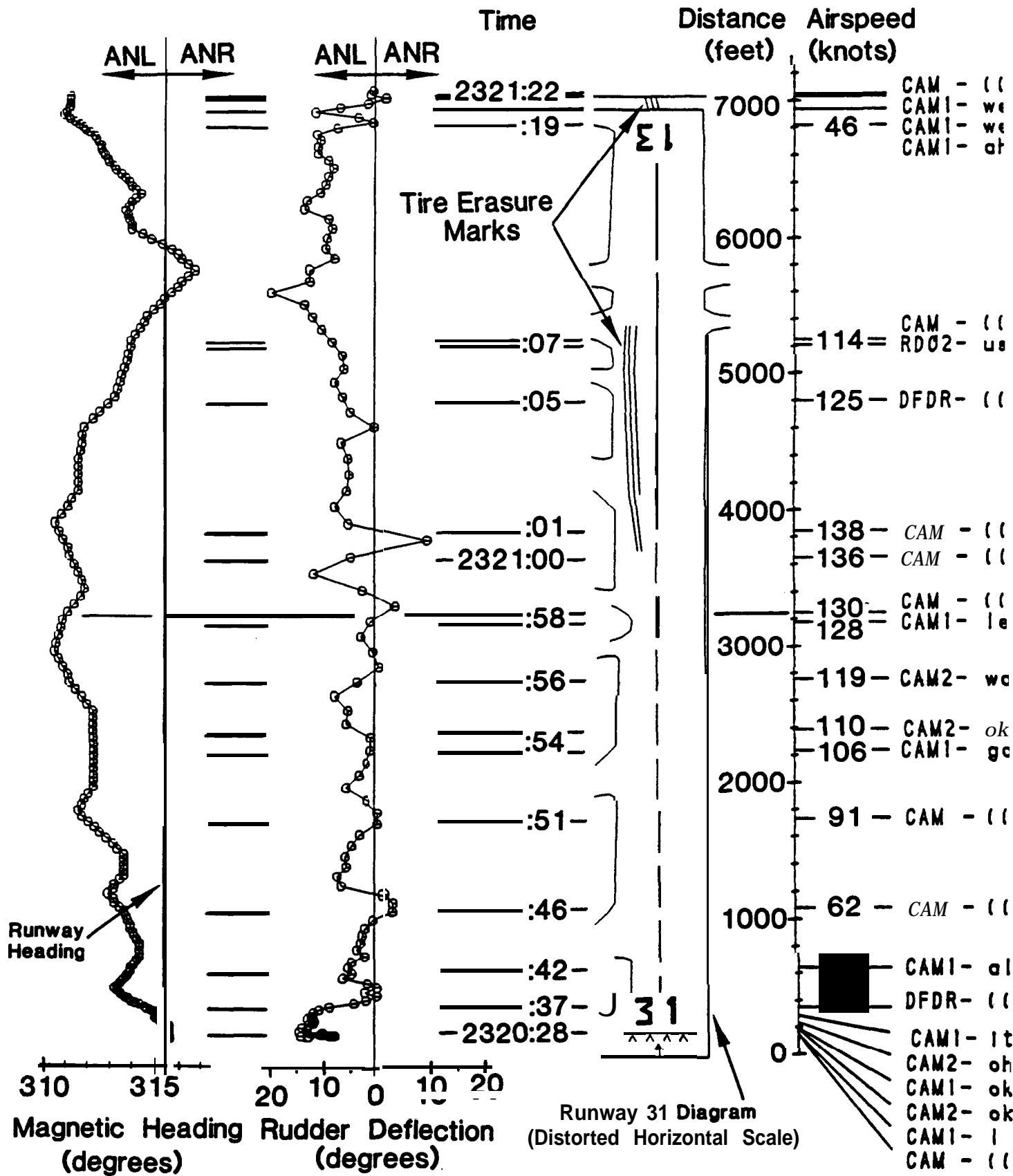

ANL,R - Aircraft Nose Left or Right

Figure 3. --DF



# Accident at LaGuardia Airport, Flushing NY

## Event

- ((sound of crash)) \_\_\_\_\_
- 1- we're going off \_\_\_\_\_
- 1- we're going off \_\_\_\_\_
- 1- ah we're going off \_\_\_\_\_
  
- ((sound of increasing engine noise)) \_\_\_\_\_
- 2- we're fifty fifty's aborting \_\_\_\_\_
  
- 3- ((thrust reversers deployed)) \_\_\_\_\_
  
- ((sound of engine noise decreasing)) \_\_\_\_\_
- ((rumble sound increases in amplitude)) \_\_\_\_\_
- ((sound similar to throttles hitting idle)) \_\_\_\_\_
- let's take it back \_\_\_\_\_
  
- 2- watch it then \_\_\_\_\_
  
- 2- okay \_\_\_\_\_
- got the steering \_\_\_\_\_
  
- ((sound of loud rumble starts)) \_\_\_\_\_
  
- ((sound of bang)) \_\_\_\_\_
  
- all right I'll set your power \_\_\_\_\_
- ((TOGA button pushed)) \_\_\_\_\_
- It's that one underneath them \_\_\_\_\_
- oh yeah I knew that or \_\_\_\_\_
- okay that's the wrong button pushed \_\_\_\_\_
- okay \_\_\_\_\_
- I got the steering till you an \_\_\_\_\_
- ((sound of increasing engine noise)) \_\_\_\_\_

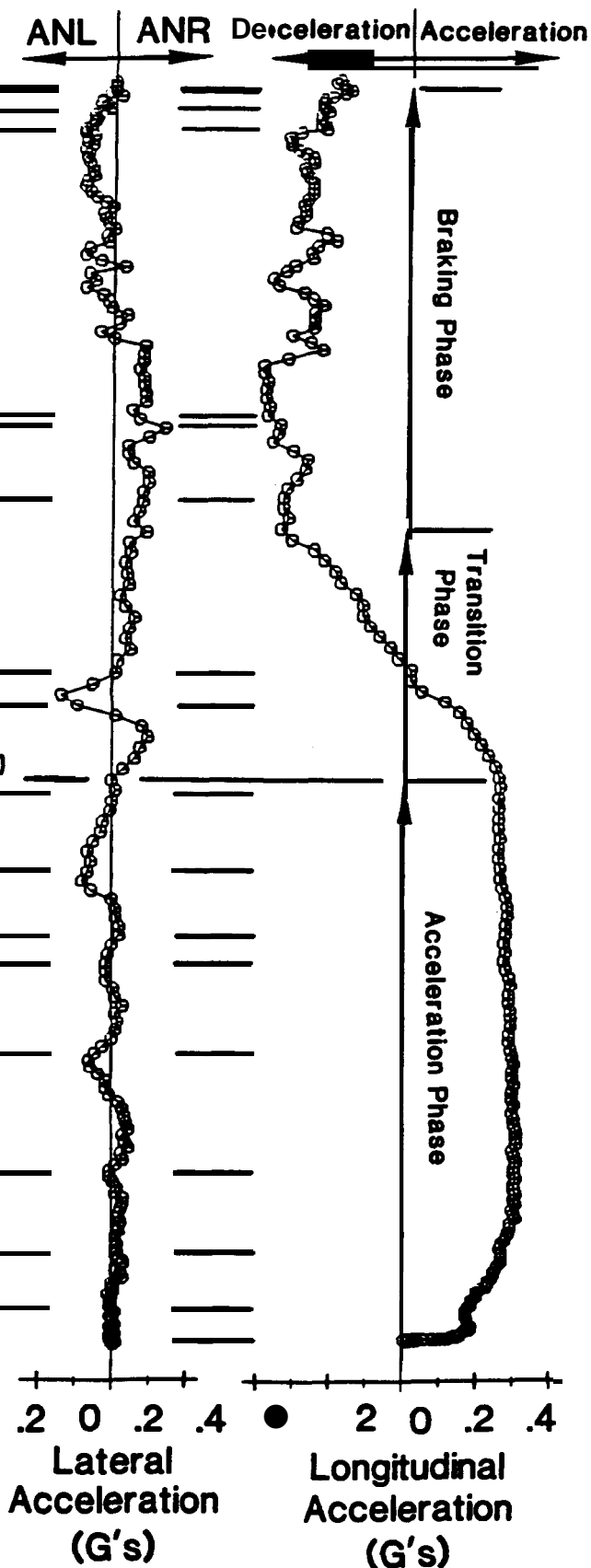

--DFDR/CVR information.



heading when an engine power reduction to idle power was recorded. The rudder was nearly centered and the airspeed was about 130 knots.

In the next five seconds, before thrust-reverser deployment, the heading began swinging to the right  $3^{\circ}$ , ground speed peaked at 143 knots and then decreased to 124 knots, and the rudder averaged  $9^{\circ}$  left; N1 decreased to its lowest values of 42.12 percent for the left engine and 43.5 percent for the right engine. The longitudinal acceleration transitioned from positive to negative during this time. Brake hydraulic pressure was not a recorded parameter.

In the final 17 seconds of recording, ground speed decreased steadily to 34 knots, heading swung right to  $316.87^{\circ}$  (right of runway heading) for one second and then swung back to the left ending at  $311.13^{\circ}$ . Thrust reversers remained deployed and N1 held steady between 88 and 89 percent. Rudder position varied from  $13^{\circ}$  left to  $2^{\circ}$  right and longitudinal deceleration peaked at  $-.41g$  8 seconds after the first power-reduction indication, then decreased to  $-.2g$ .

## 1.12 Wreckage and Impact Information

### 1.12.1 Main Wreckage

The airplane collided with a wooden approach lighting stanchion or pier as it went off the end of the overrun. The fuselage separated into three sections with the forward section resting on part of the elevated light stanchion and the aft section partially submerged (see figures 4 and 5). All fuselage fractures were due to overstress.

The bottom of the nose aft of the nosewheel well had heavy impact damage. Fragments of the pier penetrated the cockpit floor near the captain's rudder pedals. The nose gear was extended, and both nosewheel tires were attached to their wheel rims but were deflated and worn away to expose carcass plies near the center of the tread. More wear was on the left sides of both nose tires.

The left and right wings and engines were intact. Leading edge flaps one and two on the left wing had some impact damage. The trailing edge flaps were  $5^{\circ}$  down. The tires on both main landing gears were inflated and showed normal wear.

The vertical stabilizer, its control surfaces, the horizontal stabilizer and its control surfaces were undamaged. The rudder and elevator moved freely when manually operated.

### 1.12.2 Marks on the Runway

The surface of runway 31 had scrub marks from both main landing gear tires and the nose wheel tires. Pneumatic tire braking or cornering on wet pavements leave such marks as the tires remove residue from the runway leaving a clean surface. These marks started left of the centerline 3,735 feet from the runway threshold and extended to 5,400 feet from the



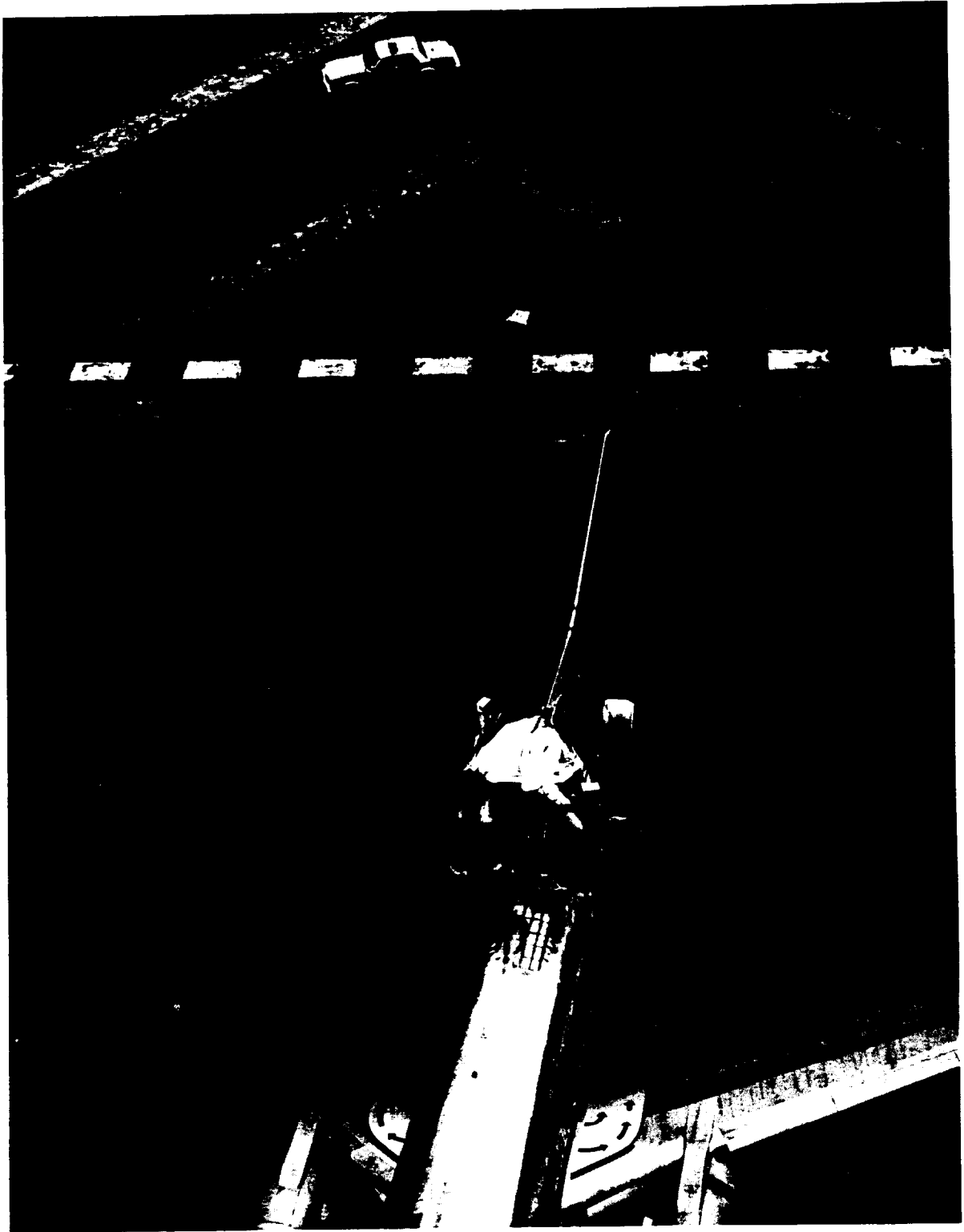

*Figure 4.--N416US at low tide.*



*Figure 5.--N416US on lighting stanchi on.*

runway threshold. About 5,000 feet from the threshold, the two nose gear scrub marks merged into one wider mark for a short distance before they disappeared. The scrub marks on the overrun reappeared at the end of the runway near the centerline and extended onto the overrun. The location of the tire marks is depicted in figure 2.

### 1.13 Medical and Pathological Information

The captain's medical insurance claims for the 12 months prior to the accident showed nothing relevant to flight status. The captain described his health as "good" and recalled no major changes just before the accident. He said he drank alcohol occasionally and his last drink was about four days prior to the accident. He said he was not on prescription medication and had no drug exposure in the 72 hours prior to the accident. He awoke about 0900 on the day of the accident after 12 hours of sleep and ate a light breakfast. The captain stated that his eating on the day of the accident consisted of two light meals before beginning duty and fruit from a crew meal later in the day.

The afternoon following the accident, medical personnel asked him for toxicological samples, but he refused upon the advice of an Air Line Pilot's Association (ALPA) representative who accompanied him. He gave a urine sample to investigators on September 22 between 1855 and 1950, 44 hours after the accident, but upon the advice of an ALPA attorney refused to give a blood sample.

Two police officers trained in detecting alcohol abuse spoke to the captain during the rescue operation and saw no signs of intoxication.

Toxicological testing of the captain's urine detected orphenadrine, a muscle relaxant in the commercial product Norgesic. Norgesic is a drug obtainable only through a physician's prescription, however, the captain stated that a fellow pilot gave him the drug after the accident to treat his injuries. All other substances tested, including alcohol, were negative.

The first officer awoke about 0930 on the day of the accident after eight hours of sleep. He ate a light breakfast that morning and a crew meal later in the day. He described his health as "average" and recalled no major changes just before the accident. The first officer said he did not drink alcohol, did not take prescription medicine, and had no drug exposure the previous 72 hours. The first officer also provided a urine sample 44 hours after the accident, and all substances tested were negative. His ALPA counsel advised the Safety Board that only a urine sample would be forthcoming.

Two passengers in seats 21A and 21B died of mechanical asphyxiation (suffocation from being crushed and unable to breathe). Seat damage and floor disruption delayed the evacuation of passengers seated in 21F and 22A.

### 1.14 Fire

No fire occurred during or after the accident.

## 1. 15 Survival Aspects

### 1. 15. 1 Seat Damage

Timber from runway lighting stanchions penetrated the left side of the cockpit. A length of wood penetrated the forward cockpit bulkhead, damaged the captain's right rudder pedal, split around the pedal, passed on both sides of the captain's right leg, and caused minor injury to him. The first officer's side of the cockpit showed no damage, and the one forward and two aft flight attendant seats had no damage.

The wreckage was not secure on the wooden pilings and in the water, so tidal movements made on-site examination of the wreckage unsafe. Salvage and transport to a secure aircraft hangar damaged the wreckage. Therefore, determining the presalvage condition of the passenger seats was impossible. Deceleration was not high enough to dislodge or overstress any seats or to separate any seat belts or shoulder harnesses. Separation and subsequent crushing of the fuselage caused the most severe seat damage in rows 21 and 22. Massive crushing of one seat and the floor occurred in row 21 on the left side of the airplane.

### 1. 15. 2 Emergency Exit Damage

The airplane exit configuration consisted of the L-1 main boarding door, the R-1 forward galley door, four Type III **overwing** exits, the L-2 aft entry door, and the R-2 aft galley door. All the exits, except the L-1 door and L-2 door were used for evacuation.

The lead flight attendant could not open the L-1 door after the airplane came to a stop. The flight attendant seated nearest the R-1 door opened that door with the help of the lead flight attendant. The evacuation slide at R-1 deployed; the R-2 slide was disarmed before the door was opened because the flight attendant believed that the slide would float upward and block the exit because of the closeness of the water. The L-2 door was opened and then closed when water entered the cabin. Both right **overwing** exits operated normally and the left **overwing** exits were not available for inspection; however, several passengers stated that they used the left **overwing** exits to evacuate successfully.

### 1. 15. 3 Evacuation

Immediately following the impact the captain performed the Passenger Evacuation checklist. He verbalized the steps of this checklist as he was sitting in his seat. The captain, the first officer, the off duty Pan American captain, flight attendants, and an airport police officer, who jumped into the water from the runway deck, assisted then passengers during the evacuation. Depending upon where the passengers were seated, their evacuations were impeded by darkness, cabin separations at seat rows 4 and 21, and the unavailable floor level exits on the left side.

About 20 passengers stood on the left wing, which was out of the water. Someone unstowed the fabric ditching line from above a left **overwing** exit and tied it to its wing fitting. These 20 passengers, including the woman with the 5 year old child and the 8-month old infant, held onto the line as they awaited rescue. The ditching line was unstowed from its right **overwing** exit opening but evacuees did not know it needed to be tied to the right wing fitting. The forward portion of the right wing was out of the water and passengers held onto the ditching line so they could stay out of the water.

Passengers who **egressed** at the two floor-level exits entered the water and because of the 1 knot current some persons drifted away from the airplane and under the runway deck. Crewmembers threw floatation seat cushions and crew life preservers, which were held by passengers and crewmembers, some of whom could not swim. Several persons complained that they could not hold onto the cushions or that the cushions did not keep them afloat. Some clung to pilings under the deck and floating debris. Some passengers also swallowed fuel that was on the water surface. Several complained that waves from boats and **downwash** from a rescue helicopter hampered staying afloat with their heads out of the water. One passenger said that she sustained a fractured right ankle and a lacerated hand when a rescue boat backed over her.

The captain and the lead flight attendant were the last crewmembers to leave the cabin after assisting rescue workers, who were attempting to extricate the passengers trapped in seats 21F and 22A. These passengers estimated that their extrication was completed 90 minutes after the accident. According to U.S. Coast Guard records, all persons had been removed from the airplane by 0102.

Problems were experienced with one hand-held, battery powered cabin megaphone--the other megaphone was not used. The lead flight attendant stated that he attempted to use it to give evacuation commands, but subsequently his commands were "squelching," [feedback] and it became more effective to simply yell the commands. Also, this megaphone ceased operating completely after it became wet later during the evacuation.

During the investigation, it was discovered that the megaphone used at the **USAir** training center had a volume knob that turned to the left to increase the volume. The lead flight attendant could not specify which way he operated the volume knob, or whether he operated it at all during the rescue sequence. The megaphone he used was not recovered following the accident.

Although crewmembers had life preservers, FAA regulations do not require life preservers for passengers aboard this flight. Flight attendants had not received ditching training in the water. It was not required by the FAA.

#### 1. 15. 4 **Emergency Response**

Air Traffic Control tower personnel stated that they observed the airplane apparently travelling too fast to stop and they used the crash phone and activated the crash alarm before the airplane departed the runway. The New York City Fire Department (NYCFD) and the U. S. Coast Guard were also notified by the controllers. The 12 Port Authority aircraft rescue and firefighting (ARFF) personnel responded with 5 ARFF trucks, 3 of which were positioned at the end of the runway deck within 90 seconds. Shortly thereafter, a Port Authority police officer jumped into the water with a large inflatable life ring from one of the ARFF trucks. At this time, some of the airplane occupants had begun to drift under the deck and vehicles were positioned to shine their headlights and spot lights on persons in the water; additional life rings were thrown to those in the water. Also, about this time an attempt was made to launch the Port Authority's 19 foot boat but the pickup truck that towed the boat-trailer could not develop traction over a dike next to the launching ramp and the boat was not launched.

The first boat to arrive (about 10 minutes after the accident) was from the New York City Police Department (NYCPD) Harbor Unit; it was joined shortly by U. S. Coast Guard boats, boats from other agencies, and the first of two Coast Guard helicopters. Passengers and crewmembers were taken to one of the three triage/assembly areas at the airport or directly to area hospitals. Rescue personnel and persons who were in the water informally estimated that the last person was taken onshore well over 30 minutes after the first boat arrived. The search and rescue activities were hampered by darkness and floating debris. Further, rescue personnel did not know how many persons were **onboard** the airplane, how many were in the water, and how many had been taken from the scene.

About 12 minutes after the accident, a NYCFD tower ladder truck arrived and, using a combination of the tower ladder and other ladders, rescue personnel climbed down to the airplane. These personnel assisted persons who were standing on the wings, treated the passengers who were trapped in the cabin, and began extrication.

The Port Authority Operations Supervisor and the Tour Commander served as the Port Authority command post from their automobiles, which were positioned away from the edge of the deck so that ARFF vehicles and off airport vehicles could be close to the edge. However, Port Authority officials found that the command post was not totally effective because the command post automobiles could not be seen among the much larger firefighting and rescue vehicles.

The U. S. Coast Guard Vessel "HAWSER" arrived on scene at 0039 and was designated as the On-Scene Coordinator vessel. Although the Coast Guard reported that all persons were out of the airplane at 0102, the search continued for possible missing persons because they did not have the flight manifest. At 0252, the Coast Guard was notified of the number of persons **onboard**, but not the number of persons who had been rescued. At 0709, the next day, the Coast Guard was informed by the Port Authority that all persons had been accounted for and the search was concluded.

Agencies involved in the rescue operation included the Port Authority of New York and New Jersey, the New York Police Department, the New York City Fire Department, including the Harbor Unit, the United States Coast Guard, the New York City Harbor Patrol, and the Rikers Island Emergency Response Unit of the New York City Department of Corrections. The New York Police Department Aviation Unit was notified of the accident but was unable to launch any of its helicopters because of poor weather conditions.

Critiques were held on September 23 and 27, 1989, to examine the emergency response by airport ARFF and off-airport agencies. Appendix E contains a synopsis of the rescue agencies' critiques and actions taken by LaGuardia Airport since the accident.

## 1. 16 Tests and Research

### 1. 16. 1 Powerplant Examination

Both CFM International CFM-56-32B engines were immersed in sea water for about 80 hours. After being removed to an aircraft hangar at LaGuardia, they were examined externally and internally but were not torn down completely. Certain components were tested or disassembled, or both.

The number 1 engine's thrust reverser cowls were 2 inches from full deployment, and the number 2 engine's cowls were fully deployed. Low pressure rotors on both engines could be rotated by hand. Thirty four of 38 fan blades on the number 1 engine had hard object damage, such as nicks, **gouges**, and tip curls. This engine had ingested its total air temperature probe during impact. All the number 2 engine's fan blades were intact, but water impact had deformed some of them to varying degrees. Low pressure turbines on both engines were not visibly damaged, and no metallic particles were in either engine's tailpipe.

Since the DFDR showed that the number 1 engine did not reach full takeoff thrust during the takeoff attempt, mechanical and electric components of its control system were tested or disassembled. These tests and disassemblies showed that all the mechanical components were capable of normal operation during the accident. The testing of electrical components showed anomalies, such as several shorts to ground and below minimum insulation resistances and signal voltages. Sea water and salt deposits were inside power management controls and transformers. The first electrical test of the main engine control turned up voltage anomalies in the rotary variable differential transformer (RVDT) that could have hampered engine power management, but the RVDT operated normally after appropriate components were baked in an oven to remove all traces of moisture.

### 1. 16. 2 Rudder Trim Examination

On-scene examination of the rudder trim system showed that the rudder trim control knob rotated freely in both directions with no evidence of binding or sticking. This control is located on the aft end of the center pedestal. The trim indicator, which is also on the center pedestal, showed an "off" flag, and there was no evidence of sticking. Extension of the

rudder trim actuator rod was 10.5 inches, corresponding to a trim position of 16° left deflection of the rudder.

Examination of the following components of the rudder trim system occurred at the Boeing facility in Seattle, Washington:

1. The rudder trim module from the center pedestal containing the rudder trim control and the trim indicator;
2. The rudder trim actuator including the rudder position transmitter;
3. The rudder centering unit;
4. The rudder pedal actuator;
5. The rudder power control;
6. The auxiliary rudder power control package;
7. The rudder trim indicator and control circuit breakers.

All components worked normally when initially tested. The rudder trim actuator failed, however, after one and one-half cycles. Disassembly revealed an electrical short circuit at a solder terminal inside the power supply module. The terminal was corroded.

Rudder-trim components that could be functionally tested against a specification control drawing were within acceptable limits, except the rudder trim indicator circuit breaker. This device needed more current than specified before it would trip.

### 1. 16. 3 Brake and Anti-skid Examination

On-scene examination of the anti-skid system revealed no major anomalies. The front metal pulltab on the anti-skid control was bent slightly, but all electrical connections appeared normal. Also, the inboard and outboard anti-skid valves in the left and right wheelwells were in good condition. Investigators loosened-the "B" nuts from all four valves and saw hydraulic fluid run out from the lines. All anti-skid hydraulic lines, fittings, fuses, and plugs were intact, as were the safety seals.

Left and right main-landing-gear brakes had no apparent damage, fluid leakage, or overheating. The left gear's outboard brake wear pins measured 1.5 inches and the inboard pins 1.2 inches unpressurized. The right gear's outboard brake wear pins measured 1.4 inches and the inboard pins 0.375 inch. Linings of the inboard brake had worn to approximately 0.0625 inch without evidence of delining. All four brakes were functionally tested after they were rebuilt 4 months after the accident. All heat stacks, bolts and other steel hardware had heavy oxidation. All running clearances were within limits, and all adjusters operated satisfactorily.



between cycles. During functional tests, one brake cylinder on each of two brakes leaked hydraulic fluid. Wear pin measurements differed slightly from those taken shortly after the accident, with the pin extended 0.15 inch on the most worn right inboard assembly.

#### 1.16.4 Simulation Studies

Applying specific thrust and rudder data from flight 5050's DFDR, several situations were examined in a B-737 engineering simulator at Boeing in Renton, Washington. Programmed into the simulations were basic accident parameters, such as runway length, airplane weight, winds, and RTO initiation speed. The simulations used coefficients of friction equal to that expected on a dry runway surface and one-half that of a dry runway, referred to herein as a "1/2 dry" surface.

Pilots who flew the simulations included a Boeing production/engineering test pilot, the Pittsburgh Flight Standards District Office (FSDO) 19 Aircrew Program Manager, the USAir Senior Director of Quality Assurance and Flight Safety, a USAir line captain and a Safety Board air safety investigator. They simulated all takeoff runs and RTO's from the captain's seat, and their conclusions were:

1. A 4 1/4-inch differential displacement of the rudder pedals made full left rudder trim readily discernable.
2. The nose wheel steering tiller alone could offset the DFDR dynamic rudder values when taking off from a dry runway.
3. The nose wheel steering tiller alone could not offset full left rudder trim or the DFDR dynamic rudder values with 1/2 dry coefficient of friction programmed.
4. Rejected takeoffs were successful with about 2,500 feet remaining after the stop on a dry runway and 1,200-1,700 feet remaining after the stop on the "1/2 dry" runway.

A second series of simulations used the USAir B-737-400 simulator with the USAir line captain (not the accident pilot) serving as first officer and the other pilots acting as captain. During these test takeoffs, the first officer controlled the rudder until about 90 knots when the captain took over. The captain aborted between 120 and 130 knots sometimes using the RTO feature of the autobrake. All the pilots agreed upon the following for the circumstances of flight 5050.

1. The first officer could have taken off successfully with full left rudder trim.
2. Confusion in the cockpit between 80 and 110 knots adversely affected the captain's actions in the RTO and lengthened the distance required to stop.

3. *The transfer of command degraded control and used up runway theoretically available for braking.*
4. *The RTO autobrake feature aided stopping.*
5. *The RTO would have been successful if normal RTO procedures had been followed.*

## 1.17 Other Information

### 1.17.1 Aircraft Systems Descriptions

#### 1.17.1.1 The Nosewheel Steering System

The B-737 has a hydraulically actuated nosewheel steering system. Steering angles up to 78° left or right of center can be attained using a nosewheel steering tiller on the left sidewall of the cockpit. Additionally, either pilot can turn the nose wheel up to 7° left or right of the center position by using the rudder pedals. However, the nosewheel steering tiller overrides any steering command by the pedals. For example, if the first officer is attempting to turn left using the pedals, the captain can override the pedal command and turn right using the tiller. Neither the position of, nor the force required on, the rudder pedals for a given rudder position will change as a result of the tiller position.

#### 1.17.1.2 The Rudder Trim System

Figure 6 shows the B-737-400 rudder trim control knob at the rear of the cockpit center pedestal. The knob is spring-loaded to its center position and electrically activates the rudder trim actuator motor only when held away from center. The motor repositions the neutral point of a hydraulic servo actuator to position the rudder up to 16° either side of center. Regardless of the trim setting the pilots' force on the rudder pedals can still move the rudder to its full deflection of 26° either side of center. A horizontally scaled indicator forward of the control knob shows rudder trim settings to the crew.

Out-of-neutral rudder trim also changes the position of the rudder pedals and the steering angle of the nosewheel when on the ground. For example, full left rudder trim will move the nosewheel 4° left, producing an offset between the rudder pedals of 4 1/4 inches. That is, the left rudder pedal will be displaced about 2 inches forward and the right pedal 2 inches aft, which affects the position of the pilot's feet correspondingly. This trim condition will cause the airplane to turn to the left during taxi or takeoff, and right tiller or pedal force must be used to straighten the ground track.

Overhead View

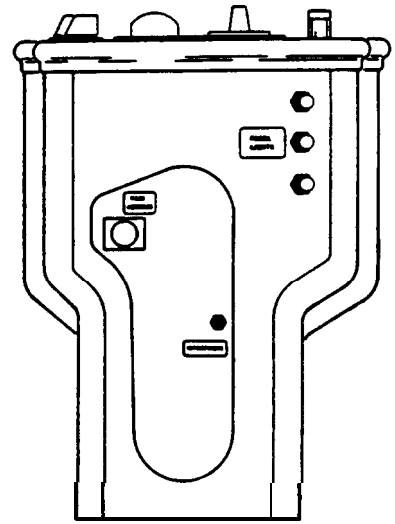
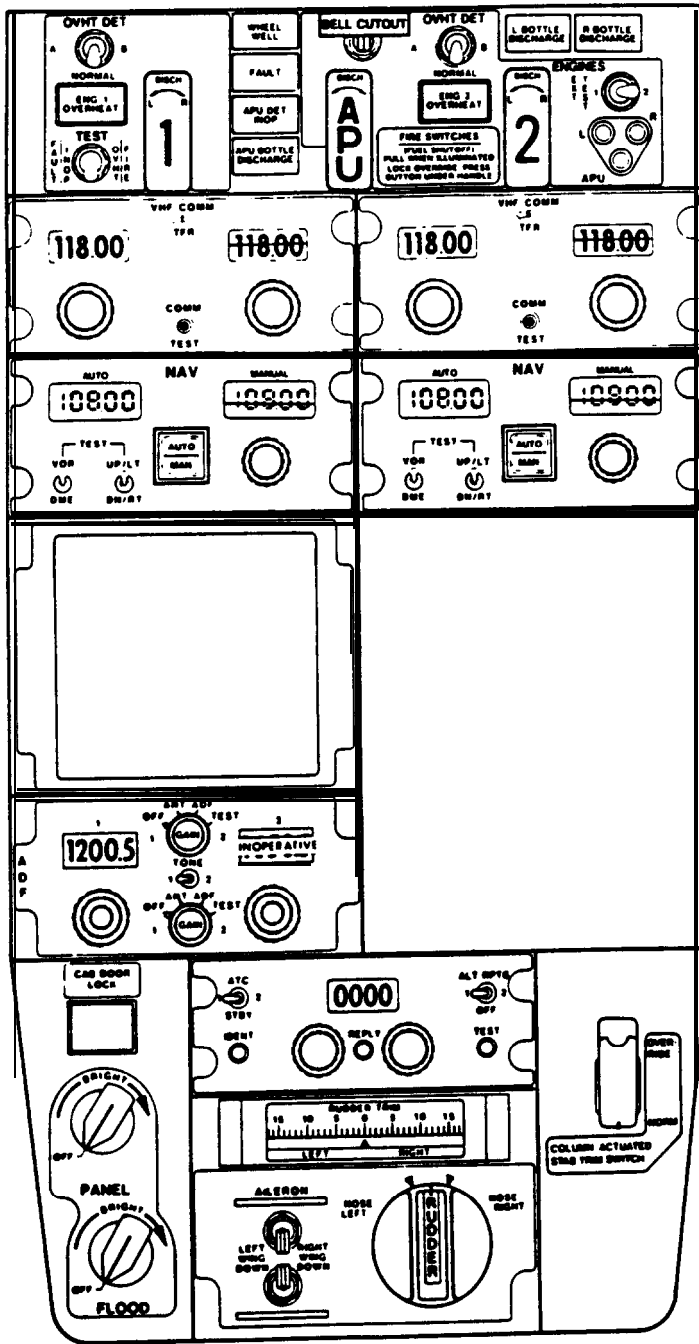

Rear View

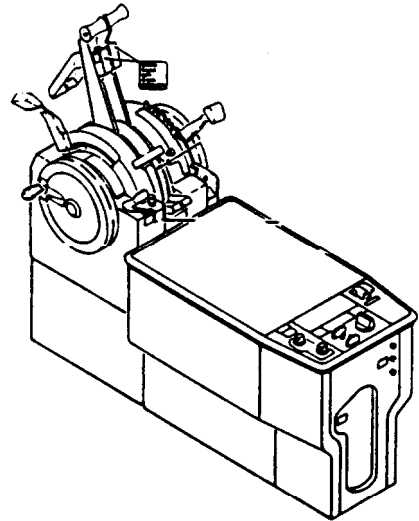

Oblique View

Figure 6. -- The B-737-400 cockpit aisle stand.

### 1. 17. 1. 3 The Autothrottle System

The Boeing 737-400 has an autothrottle system that automatically advances to takeoff power when armed and engaged at the start of a takeoff roll. The arm switch is on the autopilot flight-director-mode control panel and holds the arm position magnetically.

Once armed and then engaged by the TO/GA switch below the thrust levers, the auto throttle system will advance the thrust to  $N_1$  values preset into the limit annunciators. However, if indicated airspeed reaches 64 knots prior to completion of the thrust-setting cycle, the throttles will stop at an intermediate position and manual advancement is required to obtain takeoff thrust. Autothrottle disengage switches are on each thrust lever; once disengaged, the arm/TO/GA cycle must be repeated to reengage. If reengagement is completed before reaching 64 knots takeoff thrust will be attained automatically. An airplane can be dispatched with its autothrottle inoperative.

### 1. 17. 1. 4 The Autobrake System

When armed for takeoff, the autobrake system will provide maximum braking consistent with the antiskid function in the event of a rejected takeoff. Autobraking begins when thrust levers are pulled back to their idle stops if wheel speed exceeds 90 knots. Manual braking disengages the autobrakes, which will not reengage once deceleration begins if interrupted by manual braking. The accelerate-stop distances derived during certification are based on manual braking.

### 1. 17. 2 USAir B- 737- 300/400 Pilots Handbook Excerpts:

The following information is contained in the USAir B- 737- 300/400 Pilots Handbook:

#### Rejected Takeoff

A rejected takeoff is a maneuver performed during the takeoff roll to expeditiously stop the airplane on the runway.

As the airplane accelerates during the takeoff roll, energy increases rapidly. The energy increase is in proportion to the square of the increase in speed. This energy must be dissipated to stop the airplane. At low speeds, up to approximately 80 knots, energy developed is not sufficient to cause difficulty in stopping the airplane.

As airspeed approaches  $V_1$  for the balanced field condition, the effort required to stop the airplane on the runway for an RTO approaches maximum. After  $V_1$ , it may not be possible to stop the airplane on the runway. The decision to reject the takeoff must be made prior to  $V_1$  so that the maneuver can be initiated no later than  $V_1$  and must be accompanied by immediate accomplishment of the rejected takeoff maneuver.

Prior to  $V_1$ , a takeoff should be rejected in the event of an engine failure, engine fire, unsafe configuration, or any adverse condition significantly affecting the safety of flight.

The captain makes all rejected takeoff decisions. When alerted to the abnormal situation, the captain should call "reject" and simultaneously close the thrust levers (disengage the autothrottle, if required) and apply maximum brakes. If RTO autobrakes are selected, monitor system performance and apply manual wheel brakes if the AUTO BRAKE DISARM light illuminates or deceleration is not adequate. Rapidly raise the speed brakes and apply maximum reverse thrust consistent with conditions. Maintain reverse thrust and braking until runway length remaining permits transition to normal landing roll procedures.

**USAir** recommends arming the RTO feature on all takeoffs as it will ensure brake application early in the rejected takeoff.

#### Departure Briefing

The departure briefing shall include at least the initial heading and initial altitude restriction (i.e., Runway heading and maintain 5,000) as a standard briefing.

No two takeoffs are identical. The Captain is responsible that crews are aware of the many situations which could occur during this phase of flight that might present a non-routine situation. Normally, the Pilot flying will brief the Pilot not flying when any portion of the takeoff is anticipated to be other than routine. Items to be included in the briefing could include, but are not limited to, runway contamination, unique noise abatement procedures, presence of hazardous terrain adjacent to the flight path, or any items which may necessitate special flight or crew procedures or crew responsibilities.

#### 1.17.3 FM Oversight of **USAir**

From April 10-14, 1989, FAA Flight Standards District Office (FSDO) 19 inspected Piedmont Airlines to gauge progress of the merger between Piedmont and **USAir** and to determine if the airlines were adhering to their "mirror image" transition plan. According to the manager of FSDO 19, FAA aviation-safety inspectors made more than 75 **enroute** inspections, 25 station inspections, and numerous manual checks, checkrides, and training reviews. He stated, "The overall results of this inspection were excellent. Throughout the inspection, [Piedmont personnel] demonstrated an excellent knowledge of **USAir** policies and procedures and effectively utilized those procedures during all phases of line operations." Piedmont Airlines and **USAir** merged on August 5, 1989.

From September 18 to October 6, 1989, the FAA conducted "special surveillance" of USAir proficiency checks and training, cockpit enroute inspections, flight-crew and flight-attendant manuals, recurrent crew training, and flight dispatch procedures.

Two other incidents involving USAir flights prompted a series of FAA reviews beginning about September 8, 1989, and ending with publication of the report: USAir, Inc. Aircrew Designated Examiner/Flight Training Program Assessment in October. The findings were critical of USAir's cockpit resource training program, company policy on flight crew approach briefings, lack of crew coordination between pilots and flight attendants, stereotyped flight training and checking, monitoring of adverse training trends, deficient international dispatcher training, and several flight attendant training and equipment matters.

USAir officials disagreed with the report by saying that the programs and procedures under criticism were all approved by the FAA and in most cases exceeded basic FAA requirements. The author of the report testified at the Safety Board's public hearing that: "We recommended some technique changes. They are changes that could take place in a relatively short period of time **with[in]** the company. They have the quality people and equipment to accomplish a job. It is a matter of changing techniques in a few areas [and they are doing that] at a rapid pace at this moment."

#### 1. 17. 4 Airplane Performance

By modifying the acceleration and transition phases of longitudinal acceleration using DFDR data, investigators predicted how six different conditions would have altered the ground roll distance during flight 5050's rejected takeoff. Predictions of accelerate-stop distance in this study used acceleration and deceleration evident on the Flight 5050 DFDR rather than the more general values contained in the B-737 flight manual. The variables used to examine the six conditions were:

1. Speed when throttles are retarded to idle stops. Flight 5050's throttles were retarded at 130 KIAS, whereas the appropriate  $V_I$  speed was 125 KIAS.
2. Engine thrust during acceleration. Flight 5050 had attained thrust of only 93.1 percent  $N_1$  on the left engine and both engines took longer to reach peak thrust than normal. Calculation of full thrust assumes 94.9 percent  $N_1$  speed on both engines.
3. Time to brake. Flight 5050 reached maximum deceleration 5 1/2 seconds after the throttles were retarded to idle thrust. The calculations assumed 2 1/2 seconds as the basis for "fast braking."

The calculated ground roll distances for the examined conditions, the first of which approximates **USAir** Flight 5050, are as follows:

Case Conditions	Distance-Feet (from start of runway)
1. Slow/reduced takeoff thrust, 130 KIAS abort, slow braking	7,100 (to end of RWY 31) 7,286 (to airplane stop)
2. Full takeoff thrust, 130 KIAS abort, slow braking	6,963
3. Slow/reduced takeoff thrust, 130 KIAS abort, fast braking	6,500
4. Full takeoff thrust, 130 KIAS abort, fast braking	6,178
5. Slow/reduced thrust, 125 KIAS abort, slow braking	6,792
6. Full takeoff thrust, 125 KIAS abort, fast braking	5,810

#### 1.17.5 Inadvertent Rudder Trim Anomalies

The Safety Board collected about 90 reports of rudder trim anomalies for the Boeing **737-300/400** series airplane. The majority of these reports were received after the accident and were from pilots who had heard or read about the accident in various publications. Because many accounts omitted such identification as dates and places of occurrence, or were anonymous, duplication precluded an exact anomaly count. For instance, records failed to show whether a captain and a first officer on the same flight had turned in separate reports on the same incident.

The FAA and Boeing received most of these incident reports after the accident. Boeing knew of only six anomalies before September 20, 1989, and the FAA's maintenance **discrepancy** reports showed none. The National Aeronautics and Space Administration's (NASA) Aviation Safety Reporting System (ASRS) data base contained one from before the accident and one after.

Many reports described the inadvertent setting of rudder trim by the foot of a **jumpseat** occupant behind the captain's seat. The reports imply that casual visitors to the cockpit did not strap in, sat sideways and used

the end of the center pedestal as a footrest for their right foot. This allowed their shoe sole to push the trim knob counterclockwise and set left rudder trim. The Pan American captain who had visited the cockpit before departure of flight 5050 said that he did not rest his foot on the center pedestal at any time.

Other reports show that placing objects on the center pedestal can inadvertently turn the rudder trim knob. While the Pan American captain said that he believed the first officer placed his chart holder on the pedestal during prestart activities, the first officer did not recall having done so.

Many pilots reported rudder trim knobs sticking out of neutral after intentional activation. A knob with debris underneath or a mechanical anomaly found later on some airplanes can keep driving trim after release, in spite of it being spring-loaded to the neutral position.

Several reports show that even when trim operates properly, the trim indicator can either remain centered or show an erroneous indication.

The Air Line Pilots Association provided the Safety Board with one pilot report of a rudder trim system that on February 8, 1990, activated without operator input and "ran away" in flight.

Several of the reported inadvertent rudder trim settings were discovered by the flightcrew only after takeoff. The pilots in those incidents at first suspected engine failure as the cause of the yaw encountered and only later detected the mistrimmed rudder. They described the mistrimmed airplane as controllable in flight using the rudder.

#### 1.17.6 Corrective Actions

On October 3, 1989, USAir's Senior Director for Quality Assurance and Flight Safety issued USAir Safety Alert (89-2) asking pilots to watch for unusual rudder trim indications or unexpected settings. It continued: "The BEFORE TAKEOFF checklist item 'STABILIZER & TRIM... SET FOR TAKEOFF' is the appropriate item on the checklist to remind us to check all three trim indications (stabilizer, aileron and rudder) one last time before takeoff." Also, the airline modified its B-737-300/400 BEFORE TAKEOFF checklist to require use of the RT0 autobrake function on all takeoffs.

On December 11, 1989, a Boeing Operations Manual, Bulletin about inadvertent rudder trim on B-737-300/400/500 series aircraft recommended that the stabilizer trim item on the BEFORE TAKEOFF checklist read: RUDDER, AILERON & STABILIZER TRIM... ZERO, ZERO, UNITS. USAir so modified its checklist on February 7, 1990.

In May 1989, Boeing began to study design improvements to curtail inadvertent disturbance of rudder trim controls. On January 17, 1990, Boeing stated that it would replace the current blade-type trim knob with a round knob having finger grips around its circumference. This design change will apply to the B-737-300/400/500, the B-747-400, the B-757, and the B-767. Boeing also designed a raised shield to protect the aileron and rudder trim



controls on the B-737-300/400/500 cockpit center pedestal. Crew acceptance testing and design approval from the FAA are pending. Also, Boeing is designing an improved rudder trim indicator and has made preinstallation screening of current models more rigorous.

An FAA Notice of Proposed Rulemaking issued on January 31, 1990, proposed to require retrofit installation of the newly designed rudder trim knob and the pedestal protective shield. FAA has evaluated the rudder trim system and found no evidence of uncommanded rudder trim movement. While no further action is planned to modify the basic system, the FAA is still evaluating the need for action to prevent binding of the trim control knob or sticking of the trim indicator.

#### **1.17.7** FM Drug and Alcohol Post-accident Testing Requirements

Specific requests to **USAir** and **ALPA** to have the pilots of flight 5050 submit toxicological samples were made about 10 hours after the accident and again about 20 hours after the accident.

At the time of the accident, the FAA had yet to require post-accident toxicological testing of flight crews. On December 18, 1989, post-accident drug testing became mandatory for pilots involved in accidents. However, the rule requires urine samples only and permits a delay of up to 32 hours following the accident for samples to be taken. The manager of FAA's Drug Abatement Program testified during a public hearing that she did not know why the FAA selected 32 hours as the time limit for submission of samples. There are no federal regulations requiring pilots to be tested for alcohol following an accident, although some state authorities can request such tests.

On December 5, 1989, the Safety Board issued recommendations to the U. S. Department of Transportation regarding the development of uniform regulations to be adopted by the regulatory agencies of all transportation modes. The recommendations were as follows:

##### A-89-4 through A-89-7

Develop post-accident and post-incident testing regulations that are separate from the pre-employment, **random**, and reasonable suspicion testing regulations in **all** modal agencies. (Class II, Priority Action) (A-89-4)

Adopt uniform regulations for all drug and alcohol testing, other than post-accident and post-incident testing, in all transportation modes, including U. S. Department of Transportation employees who are in safety-sensitive positions.

Adopt uniform regulations on post-accident and post-incident testing of private sector employees for alcohol and drugs in all transportation modes. Use the Federal Railroad Administration's (FRA) current regulation as a model

regulation for all transportation modes except for the permissible blood alcohol level of less than 0.04 percent. Using the FRA regulation as a model for other transportation modes refers only to the collection of blood and urine and the screening and confirmation of positives in blood. As a minimum, the drugs identified in FRA screen should be used in the other modes. Reference to the FRA model does not refer to the administration or implementation of the regulation. The Safety Board recognizes that the implementation of the regulation may be different in the various transportation modes. The regulations for all modes should provide:

- o for the collection of blood and urine within 4 hours following a qualifying incident or accident. When collection within 4 hours is not accomplished, blood and urine specimens should be collected as soon as possible and an explanation for such delay shall be submitted in writing to the administrator.
- o testing requirements that include alcohol and drugs beyond the five drugs or classes specified in the Department of Health and Human Services (DHHS) guidelines and that are not limited to the cutoff thresholds specified in the DHHS guidelines. Provisions should be made to test for illicit and licit drugs as information becomes available during an accident investigation.

#### 1.17.8 Public Hearing Testimony on Accident-Related Subjects

Although the captain did not mention any abnormal rudder pedal condition during initial post-accident interviews, when asked about such a condition at the public hearing, he stated:

Yes. I had some degree of awareness that the rudder pedals were not even. This did not present any particular problem to me, I believe due to the military transport experience that I have where it would not be uncommon at all to taxi this airplane [the C-1301 and the rudder pedals be uneven during taxi. And I was also not having any problem during the taxi stage.

#### 1.17.9 Pilot Experience and Pairing

After the Continental Airlines Flight 1713 accident on November 15, 1987, at Denver, Colorado, the Safety Board issued Safety Recommendation A-88-137 asking the FAA to specify minimum experience for each pilot-in-command and second-in-command and to prohibit the pairing of pilots on the same flight who have less than the minimum experience at their respective positions.

The FAA responded with an Air Carrier Operations Bulletin on January 21, 1988, urging its principal operations inspectors to promote minimum experience criteria for pilot pairing. In the summer of 1988, an FAA survey showed that 41 percent of the 14 CFR Part 121 carriers had policies on crew pairing. Based upon this survey and the "expected degree of voluntary compliance with [crew pairing] scheduling practices" the FAA determined that rulemaking was unnecessary and planned no further action. The Safety Board called this response an "Open-Unacceptable Action."

Notwithstanding its earlier disagreement with this Safety Board recommendation, after the USAir accident, the FAA informally asked the Air Transport Association-hosted Joint Government/Industry Task Force on Flight Crew Performance to examine the crew pairing issue and to develop proposed industry guidelines for air carriers. A special Crew Pairing Committee was formed, composed of government and industry representatives, which has met several times since December 1989. The Committee has developed preliminary recommendations that call for more structured initial operating experience for newly trained pilots and more timely completion of it; impose operating restrictions under specified weather and other conditions; and prohibit the pairing on the same flight of pilots who have less than a specified minimum experience in their respective positions.

In addition to restrictions on crew pairing, the Committee's recommendations stressed the importance of a concerted, uninterrupted period of line operating time, including Initial Operating Experience (IOE) to foster the consolidation and stabilization of pilots' newly-acquired knowledge and skills. The Committee recommended that the consolidation period begin at the initiation of IOE, consist of 100 hours of line operating time, and be completed within 120 days. Failure to complete consolidation within this time would require observation of two satisfactory cycles by a line check airman before continuation of the program.

Additionally, with regard to crew pairing restrictions, the FAA initially suggested to the Committee that an initial pilot-in-command and an initial second-in-command pilot not be paired together if both have less than 150 hours, including IOE, in the position on the airplane in which they have most recently qualified. The Committee has recommended less than 150 hours.

The Committee is currently revising and refining its recommendations based on comments received from the FAA. The FAA has informally advised the Committee that it intends to initiate a proposed rulemaking project, based in part on these recommendations, to amend its air carrier flight crew operating experience regulations.

#### 1. 17. 10 Rejected Takeoff Special Investigation

On February 27, 1990, the Safety Board issued Special Investigation Report SIR-90-02: **Runway Overruns Following High Speed Rejected Takeoffs.** Although this Special Investigation had begun before the accident at LaGuardia, the report made recommendations on proper definition of VI speed, dissemination of VI aircraft certification data to 14 CFR 121 operators, crew coordination during rejected takeoffs, and fleet standardization of rejected

takeoff procedures among airplanes of the same type. FAA response is pending.

#### 1. 17. 11 Runway Safety Areas

The Safety Board expressed its concern about runway safety areas following a Texas International Airlines DC-9 accident at the Stapleton International airport, Denver, Colorado on November 16, 1976. The airplane overran the runway during a rejected takeoff. Subsequent to the accident, the Safety Board recommended that the FAA:

##### A-77-16

Amend 14 CFR 139.45 to require, after a reasonable date, that extended runway safety area criteria be applied retroactively to all certificated airports. At those airports which cannot meet the full criteria, the extended runway safety area should be as close to the full 1,000-foot length as possible.

The FAA's initial response, dated July 11, 1977, stated that this recommendation would place an economic burden on airport operators. They did propose, however, an amendment to 14 CFR Part 139 that would require extended safety areas concurrently with construction of new airports, runways, and major runway extensions at existing airports. On October 23, 1985, the FAA published Notice of Proposed Rulemaking (NPRM) No. 85-22, 'Revision of Airport Certification Rules,' published at 50 FR 43094. In its response to the NPRM, the Safety Board supported the proposed section 139.307, "Safety Area," which would require that safety areas conform to the criteria in effect at the time of an expansion of a runway, or at the time of certification. While the Safety Board continued to stress that criteria for runway safety areas should be made mandatory at all certificated airports regardless of the date of construction, it was sensitive to the practical and economic difficulties of implementing such a requirement.

On October 16, 1987, as the result of an accident at the Charlotte Douglas International Airport, Charlotte, North Carolina, in which a Piedmont Airline B-737 overran the end of runway 36R and struck a concrete culvert 318 feet beyond the departure end of the runway, the Safety board issued another recommendation to the FAA concerning runway safety areas:

*Required airport managers to repair areas and/or remove obstacles, such as concrete culverts, that are adjacent to airport operating areas. Such repairs should be performed at the earliest opportunity. (Class II, Priority action) (A-87-107)*

Also, on October 16, 1987, the Safety Board issued a recommendation to the American Association of Airport Executives (AAAE) and the Airport Operators Council International, (ACI) Inc. :

*Inform its members of the circumstances of the aircraft accident at Charlotte Douglas International Airport on October 25, 1986, and request its membership to repair areas and/or remove obstacles, such as concrete culverts, that are adjacent to airport operating areas. Such repairs should be performed at the earliest opportunity. (Class II, Priority Action) (A-87-112)*

On November 17, 1987, the FAA revised 14 CFR 139 in response to comments on its NPRM of October 23, 1985. With regard to Safety Recommendation A-77-16, on March 29, 1990, the Safety Board replied to the FAA:

*"In Safety Recommendation A-77-16, the Safety Board recommended that the FAA amend 14 CFR 139.45 to require, after a reasonable date, that the extended runway safety area criteria be applied retroactively to all certificated airports. At those airports that cannot meet the full criteria, the extended runway surface area should be as close to the full 1,000-foot length as possible. While we note that the revised regulations call for safety areas to meet current dimensional criteria, to the extent practicable, if construction, reconstruction, or significant expansion of runways/taxiways began on or after January 1, 1988, we are concerned that there is no retroactive requirement for upgrading existing safety areas to the new dimensional criteria. Based on the lack of a retroactive requirement, the Safety Board has classified Safety Recommendation A-77-16 as "Closed--Unacceptable Action."*

With regard to Safety Recommendation A-87-07, on January 28, 1988, the Safety Board placed it in a "Closed--Acceptable Action" status based on the FAA's November 18, 1987, amendment to 14 CFR 139 that extends the runway safety area and on the FAA's willingness to instruct its Airport Certification Inspectors to encourage Airport operators to remove, to the extent practical, all objects outside the designated runway safety area but within the dimensions of an extended runway safety area defined by the FAA's current design standards.

Also, on March 23, 1989, the Safety Board classified Safety Recommendation A-87-112 as "Closed--Acceptable Action based on **ACI's** and **AAAE's** actions to inform their members of the need to remove hazards adjacent to airport operating areas.

#### 1. 17. 12 Overwater Emergency Equipment

The Safety Board's Special Study entitled "Air Carrier Overwater Emergency Equipment and Procedures", (NTSB-SS-85-02) dated June 12, 1985, stated in part:

All air carrier aircraft which operate under 14 CFR 121, 125, or 135 operations should be required to carry certain basic water survival equipment: approved flotation seat cushions and, for each occupant on board (including infants), an approved life preserver. As discussed below, the Board considers this equipment to be essential when overwater operations are involved. The FAA staff study found that at least 179 fully certificated airports in the U.S. are located within 5 miles of a body of water of at least one-quarter square mile surface area (certificated airports in Alaska were not included, although a high percentage are near water). Virtually all aircraft used by Parts 121, 125, and 135 operators use one or more of these 179 airports (or may need to use one of them in an emergency). Thus, many passengers are exposed to risk of inadvertent water impact near an airport, whether or not their flight is classified as an "extended overwater" flight.

The Safety Board's Special Study made three safety **recomendations** to the Federal Aviation Administration:

##### A-85-35

Amend 14 CFR 121 to require that all passenger-carrying air carrier aircraft operating under this Part be equipped with approved life preservers meeting the requirements of the most current revision of TSO-C13 within a reasonable time after the adoption of the current revision of the TSO; ensure that 14 CFR 25 is consistent with the amendments to Part 121.

##### A-85-36

Amend 14 CFR 125 to require that all passenger-carrying air carrier aircraft operating under this Part be equipped with approved life preservers meeting the requirements of the most current revision of TSO-C13 within a reasonable time after the adoption of the current revision of the TSO; amend Part 125 to require approved flotation-type seat cushions (TSO-C72) on all such aircraft; ensure that 14 CFR 25 is consistent with the amendments of Part 125.

**A-85-37**

Amend 14 CFR 135 to require that all passenger-carrying air carrier aircraft operating under this Part be equipped with approved life preservers meeting the requirements of the most current revision of TSO-C13 within a reasonable time after the adoption of the current revision of the TSO; amend Part 135 to require approved flotation-type seat cushions (TSO-C72) on all such aircraft; ensure that 14 CFR SFAR No. 23 is consistent with the amendments to Part 135.

1988: The Federal Aviation Administration responded on December 23,

"On June 27, 1988, the FAA issued NPRM No. 88-11 (Docket No. 25642). The comment period ended November 28, 1988. This NPRM addresses the issues of these safety recommendations and proposes new requirements for water survival equipment carried aboard airplanes and rotorcraft. The requirements would apply, after specified dates to U.S. certificate holders that conduct common carriage operations with airplanes and rotorcraft."

On November 28, 1988, the Safety Board responded to NPRM-88-11:

"... The Safety Board is pleased that a requirement for flotation-type seat cushions would be required on Parts 121 and 135 aircraft as was called for in Safety Recommendation A-85-37. However, the Safety Board is concerned that the proposed rulemaking does not include passenger-carrying aircraft operating under 14 CFR 125 and strongly recommends that the FAA extend the same protection to passengers on board 125 operators as called for in Safety Recommendation A-85-36. Further, the Safety Board supports Safety Recommendation A-85-35 through -37 to amend 14 CFR 121, 135, and 23 to require air carriers to install life preservers that meet TSO-C13e within a reasonable time.

"The proposed rulemaking states: A passenger life preserver must be located at each passenger seat or in the immediate vicinity of the seat. Although the proposed rule does not prohibit the under seat storage of life preservers, the Safety Board urges the FAA to encourage unique and innovative ways to store the life preservers to avoid the problems as cited in our Special Study. The Safety Board remains concerned that under seat storage is not a desired location for life preservers based on its accident investigation experience.

"The Safety Board notes that the proposed Parts 121.571 and 135.117 are partially responsive to Safety Recommendation A-85-89 dealing with pre-departure passenger briefings and should be part of the final rule. However, we continue to

believe that Part 125 should also be amended as called for in this safety recommendation. Also, it is noted that the FAA has not addressed the differing requirements for and standardization of survival equipment/tools in this proposed rulemaking. The Safety Board believes that these requirements need to be included in the proposed rulemaking action and urge that the provisions of Safety Recommendation A-85-40 be included in the rulemaking. . . "

On February 21, 1989, the Safety Board responded to the FAA response to these recommendations "...We await the Federal Aviation Administration's regulatory action to make our further evaluation. These recommendations are classified as Open--Acceptable Action. "

On July 2, 1985, the Safety Board recommended that the FAA:

A-85-49

Amend relevant emergency training sections of 14 CFR 121, 125, and 135 to require the cockpit and cabin crewmembers on aircraft being operated under these Parts be given periodic training, including hands-on "wet" drills, in the skills relevant to inadvertent water impact which may increase the chances of post-crash survival.

On January 23, 1989, the FAA responded:

" . . . Because of the diversity of the comments received, the FAA has decided to incorporate some of the subject areas discussed in the AC into an Air Carrier Operations Bulletin (ACOB). One of the subject areas that will be addressed in the ACOB is "hands-on" drills. It is anticipated that the ACOB will be issued in the fall of 1989. Until the Safety Board has the opportunity to review this ACOB, the status of this recommendation is "Open-Acceptable Action. "



## 2. ANALYSIS

### 2.1 General

The investigation showed that the flight and cabin crew were qualified to perform their duties under Federal and company regulations. The pilots were well rested prior to their crew-duty day and recalled no personal matters that would have hindered their flying.

Maintenance and operation of **N416US** complied with Federal and company specifications, and no evidence suggested that pre-existing structural discrepancies or flight-control system or engine anomalies contributed to the accident. The evidence indicates that the takeoff attempt with full left rudder trim precipitated the accident. The investigation also showed that the airplane was controllable with full left rudder trim and could have been flown with the appropriate operation of available flight controls. Lastly, the investigation showed that the airplane could have been stopped on the runway after the takeoff was rejected.

The Safety Board analyzed:

- o The activation of the rudder trim to the full trim position.
- o The flight crew's failure to detect the mistrimmed rudder.
- o The rudder trim control design.
- o The flight crew's directional control difficulties.
- o The RT0 decision.
- o The B-737-400 braking performance and the use of autobrake system.
- o The flight crew's performance and coordination.
- o The post accident survival factors.

### 2.2 Activation of the Rudder Trim

Data from the DFDR showed that rudder trim on **N416US** was neutral after arrival at the **USAir** gate at LGA. The DFDR subsequently shut down. When repowered after engine start for flight 5050, the DFDR showed that the rudder had moved to the full left trim position. Electrical and hydraulic power from the Auxiliary Power Unit (APU) were available during the intervening period to change the rudder trim position, if commanded. The time to run trim from neutral to full left is about 30 seconds, so momentary knob rotation would not have produced full left trim.

The raised-blade design of the knob and its unguarded location at the edge of the center pedestal made it vulnerable to inadvertent actuation by a person in the jump seat who could have pushed the knob counterclockwise with his or her foot. Although the visiting captain said that he did not use the center pedestal as a footrest, either he or other individuals not identified during the investigation had the opportunity to rotate the knob inadvertently. Also, an object placed on the center pedestal could have wedged against and rotated the knob to drive the trim out of neutral. Although the visiting captain said that the first officer may have had a chart binder on the console, the first officer disagreed.

It is possible that the rudder trim knob was momentarily moved and jammed out of neutral either because of debris underneath or an internal malfunction. The Safety Board believes that either occurrence is unlikely since the knob operated satisfactorily after the accident.

Finally, a USAir B-737-300/400 pilot said that he had encountered an uncommanded electrical runaway of rudder trim about 4 1/2 months after the accident. However, investigators could not positively determine the findings of maintenance after the occurrence. The Safety Board does not believe that an uncommanded trim runaway occurred on Flight 5050 because circumstances that would lead to such an event have not been substantiated.

The Safety Board concludes that a person or object inadvertently moved the rudder trim knob while the airplane was between flights, and the crew failed to note the mistrimmed condition during preparations for flight 5050's departure.

### 2.3 Crew Failure to Detect the Mistrimmed Rudder

The captain could have noticed the misset rudder trim almost immediately after engine start, even before he began taxiing away from the gate, because the rudder pedals were offset from each other by 4 1/4 inches. He did not mention the offset to investigators 2 days after the accident. However, after the DFDR evidence indicated the trim anomaly, he said that he had noticed the offset pedals, adding that the offset did not bother him because he was used to taxiing with offset pedals in the C-130. The C-130 rudder control system is reversible because air loads acting on the rudder surface will cause rudder movement that will feed back through the control system to move the rudder pedals. Thus, it is normal when taxiing a C-130 for the rudder pedals to move as a crosswind or **jetblast** acts on the rudder. However, the B-737 control system is irreversible; air loads on the rudder will not cause rudder or rudder pedal movement. While the captain was relatively inexperienced in his position, the Safety Board believes that he should have been aware of these different airplane characteristics. Even in a C-130, it would be unusual for the pedal position to remain at a constant offset as the airplane changed direction during taxi.

Although the captain had more than 2,600 flight hours in the B-737, he had only about 140 hours in the left seat. Since taxiing is performed only from the left seat, his taxi experience was somewhat limited. However, the full rudder trim would also have turned the nose wheel about 4° left,

Yawing moments caused by rudder deflection will increase with increasing airspeed; but even with full trim, the rudder can be deflected to a position fully opposite to trim by the application of force on the rudder pedals. Upon reaching a speed at which the rudder is aerodynamically effective, the rudder pedals alone can be used to keep the airplane rolling straight. At lower speeds, the nosewheel steering must be used.

According to the B-737's Airplane Flight Manual (AFM), use of the nosewheel tiller after receipt of takeoff clearance is only for alignment of the airplane with the runway. After alignment, rudder pedal steering should be used to maintain directional control during takeoff. On the B-737, rudder pedals give the nose wheel up to 7° of steering to assist during the early part of the takeoff roll. But the captain testified that he tried to use the steering tiller to maintain runway alignment until he rejected the takeoff.

According to Boeing's Chief B-737 Test Pilot, the nosewheel steering is effective only until the rudder gains aerodynamic authority. Afterward, the nosewheel tires cannot produce sufficient cornering force to redirect the airplane in opposition to the aerodynamic force resulting from rudder deflection. Using Flight 5050's gross weight, an engineering simulator showed that, at more than 81 knots on a dry runway and 64 knots on a wet runway, nosewheel steering alone could not turn the airplane in opposition to 16° of rudder deflection.

Data from flight 5050's DFDR confirms that the first officer applied some force on the right rudder pedal while the airplane accelerated for takeoff; but this pedal force was insufficient as the rudder became more aerodynamically effective, and at 91 knots the nose veered left. At 106 knots, the CVR recorded the captain saying "got the steering." He later testified that he said "you got the steering," advising the first officer to correct with right rudder. However, the first officer testified that he thought that the captain said: "I got the steering" and that he expected the captain to take control of the rudder. The first officer then said "okay" and at 110 knots relaxed force on the right pedal gradually to prevent rapid veering to the left. The rudder deflection changed from about 1° left to 8° left, consistent with the first officer's statement that he relaxed force on the pedal.

The first officer testified that he never felt the captain overpower his rudder pedal force. At 119 knots and fewer than 3 seconds after the captain's comment "got the steering," the DFDR lateral accelerations show that the airplane swerved to the left. Apparently, neither pilot was fully in control of the airplane, as both of them seemed to expect the other to steer.

The captain testified that he tried to halt the leftward track of the airplane by using both rudder pedal and the nosewheel steering tiller prior to rejecting the takeoff. But the DFDR data refutes such an occurrence because it indicates a maximum rudder deflection of only 1 degree right during the 4 1/2 seconds from "got the steering" to the captain's signaling his rejection of the takeoff by saying "let's take it back." Although 10

nose-right rudder required about 58 lbs on the right pedal, neither pilot applied the 71 lbs. of force needed for full right rudder.

When the captain took control of the airplane to initiate the RTO, he faced an unknown and complicated directional control situation. The first officer had been reacting to the nose-left tendency by depressing the right pedal, but the captain does not remember the first officer's warning about this. Therefore, the need for a large amount of force on the right rudder pedal probably was a complete surprise to the captain at a critical time in the takeoff. His testimony, DFDR rudder data, the rumble sound on the CVR indicating extreme nosewheel deflection, and the physical evidence on runway 31 indicate that the captain was relying on the nosewheel steering tiller for directional control instead of the rudder pedals. The combination of the captain's use of the tiller, and his failure to detect the first officer's rudder commands apparently led the captain to falsely believe that the tiller was effectively maintaining directional control. Consequently, instead of applying force to the right rudder pedal, he continued to depend on the nose wheel steering tiller, and the airplane veered further to the left complicating the captain's subsequent actions to stop the airplane.

## 2.6 The RTO Decision

History has shown that most of the RTOs that have resulted in runway overrun accidents have been initiated for reasons other than engine failure and, in many cases, the RTO's were not necessary because the airplanes could have taken off safely. The awareness of these occurrences has prompted the airline industry to emphasize the philosophy that after reaching high speeds (generally accepted as 100 knots), flight crews should reject takeoff only when an engine fails before  $V_1$  or there are clear indications that a condition exists that will significantly affect the safety of flight. USAir provided such guidance in their training program and the USAir B-737-300/400 Pilot's Handbook.

The captain of flight 5050 had several indications of a problem during the takeoff roll before the airplane reached 100 knots. First, he must have been aware of the first officer's difficulty in maintaining runway heading as more and more nosewheel steering commands were applied by the tiller; second, the sound of the "bang" occurred at 62 knots and the subsequent rumble was heard at 91 knots. The Safety Board believes that the captain should have decided to reject the takeoff immediately. Having failed to do so, he must have been aware that the airplane was accelerating and rapidly approaching the  $V_1$  speed, even though he failed to make the 80 knots and  $V_1$  callouts. With such awareness, the captain should have given his total attention to control of the airplane with the rudder pedals and continued the takeoff.

Either pilot was physically capable of but did not use substantial right rudder to maintain directional control. The Safety Board concludes that because the pilots had full rudder authority, a safe takeoff was possible, and that the pilots could have corrected the mistrim condition after lifting off. Successful takeoffs have been accomplished four times

with full rudder trim and five times with partial rudder trim, according to reports from B-737-300/400 pilots located during this investigation.

The investigation showed that the captain had not experienced a tire failure or non critical event at high speed during takeoff in either simulator training or line flying operations. The Safety Board's Special Investigation of Runway Overruns Following High Speed Rejected Takeoffs found that USAir RTO training was not unique in his regard, that most airlines present only engine failure situations during simulator training. Moreover, the critical safety margin of the RTO may not be readily apparent to the trainee as he succeeds without difficulty in stopping the simulator with runway remaining because the RTO scenario or the simulator characteristics were not representative of the most critical line operations.

The Safety Board addressed these issues in its Special Investigation Report and in safety recommendations contained in Section 4.0.

## 2.7 Braking Performance

The B-737-300/400 AFM shows that flight 5050 could have departed from a runway of 4,460 feet. The  $V_1$  reject speed for this balanced field (accelerate to  $V_1$  and stop) takeoff is 125 knots, the same as specified for flight 5050. AFM distances assume a dry runway, stopping without the use of reverse thrust, thrust slightly less than the average production engine, and an additional distance equivalent to 2 seconds at  $V_1$  to account for in-service variation of pilot response. The  $V_B$  speed is  $A_1$  speed when full braking is achieved, which happens to equal  $V_1$  for flight 5050.

The Safety Board has had a longstanding concern that the AFM stopping performance is based upon dry runway tests without allowance for the reduced friction coefficient on wet surfaces. To compare the stopping performance of flight 5050 with that achievable on the wet runway, investigators measured runway friction under conditions similar to those existing on September 20, 1989, and applied an appropriate correction to airplane stopping performance calculations. A coefficient of friction equal to  $1/2$  of the dry runway coefficient of friction was considered conservative based upon the results of the NASA tests.

The Boeing calculations showed that a B-737-400 should have stopped after an RTO initiated at a 125 knot  $V_1$  speed using 4,050 feet on a dry runway and 5,670 feet on the " $1/2$  dry" runway, both without consideration for reverse thrust. That flight 5050 failed to stop on a 7,000 foot runway is of concern to the Safety Board. In fact, an extrapolation of DFDR acceleration data when the airplane left the runway shows that flight 5050 would have used about 7,280 feet to come to a full stop, assuming that the deceleration rate was maintained.

In addition to variations in the runway friction, several other factors affect the airplane's braking performance and extend the distance required to stop the airplane beyond that demonstrated or theoretically derived from certification tests. Among these factors are the distance used to accelerate the airplane, the RTO initiation speed, and the distance used

because of variations in pilot response times to apply maximum braking and reconfigure the airplane. The Safety Board considered each of these factors to determine why flight 5050 did not stop on the available runway surface.

The first factor considered was the distance used for acceleration. Although flight 5050 accelerated rapidly, the evidence showed that full takeoff thrust was not achieved and the thrust used was attained with some delay. Safety Board studies indicate that flight 5050 would have reached the speed at which the RTO was initiated using 320 feet less runway had the thrust advanced normally with use of the autothrottle. More significantly, the captain delayed his action to reject the takeoff until the airplane had accelerated to, or beyond, the prescribed VI speed. The DFDR data showed that the throttles were retarded to idle thrust at 130 knots, 5 knots above the speed for which AFM stopping distance was based. The Safety Board's study showed that, other factors notwithstanding, the 5 knots of additional speed increased the required stopping distance by 494 feet.

The order of actions in a rejected takeoff are full braking, throttle reduction, extending the spoilers, and applying reverse thrust when available. Such actions are considered the full braking configuration. Wheel braking develops most of the decelerating force, and full wheel braking at high speed depends on rapid spoiler deployment. The spoilers serve two purposes: to increase drag for deceleration and to place weight on the tires for braking by reducing wing lift. If the pilot does not extend the spoilers, automatic deployment comes with reverse thrust. Flight 5050's DFDR data shows that the thrust reversers unlocked 5 1/2 seconds after the rejected takeoff started and about 4,800 feet from the beginning of the runway. The captain testified that he could not remember extending the spoilers or if the selection of reverse thrust automatically extended them. Spoiler position was not recorded on the DFDR. Thus, the Safety Board could not determine whether late deployment of the spoilers delayed the attainment of full braking force.

When the captain took control to reject the takeoff, he needed to correct the **leftward** tracking and apply maximum braking without delay. The evidence shows that maximum braking was not achieved immediately. The DFDR thrust and rudder position data indicate that the captain relied only on the differential braking and nosewheel steering to correct the airplane's heading. The captain's testimony confirmed that he attempted first to correct the **leftward** track. As a result, the DFDR data showed that the maximum deceleration was not achieved until 5 1/2 seconds after the initial RTO action was taken, whereas the AFM data assumed an increment of only 1 second from brake application to achieve maximum deceleration. In analyzing the captain's performance, the Board assumed a reaction time of 2 1/2 seconds from brake application to achievement of maximum deceleration as being reasonable. The Safety Board's study indicated that the additional 3 seconds of delay added 786 feet to the theoretical stopping distance required.

Based upon these calculations, the Safety Board concludes that flight 5050 could have been stopped on the 7,000 foot runway had the captain taken more timely actions to achieve maximum braking after his decision to

reject the takeoff. Further, the Safety Board observed that maximum braking would have been achieved sooner, irrespective of the captain's actions or his directional control problems, if he had used autobrakes.

The captain chose not to use the RTO feature of the autobrake system during the accident takeoff run, despite recommendations from both Boeing and USAir.

The first officer's observation that he never took off without selecting the RTO autobrake function during his recent training suggests USAir actively encourages using autobrakes on takeoff. Boeing personnel said that during aircraft certification testing under near-perfect conditions, a pilot expecting a rejected takeoff might manually brake as fast as the autobrake. However, such an occurrence is unlikely during line operations.

The Safety Board believes the captain should have used autobrakes and his failure to do so suggests that its use may not have been appropriately emphasized during line operations. The lack of autobraking was a factor in this accident. The captain said that he believed steering the airplane back to the centerline was necessary prior to applying full brakes. Manually applying full brakes and full rudder is possible during a high-speed abort but borders on being an unnatural action because the pilot's feet are in slightly different positions for braking and for rudder. Use of the autobrake would have freed the pilot to concentrate on maintaining directional control with the rudder while still achieving maximum braking.

The Board has heard the argument that autobrakes may throw passengers against seatbacks during low-speed aborts. This logic is spurious since the B-737-400's autobrakes are not active until ground speed reaches 90 knots. Moreover, serious injuries and deaths during unsuccessful high-speed aborts far outweigh the few, if any, minor injuries that might occur during low-speed rejected takeoffs.

## 2.8 Engine Performance

While rudder mistrim was the precipitating factor in this accident, other disparities appeared in some DFDR engine parameters.

Fan speed (N1) increased slowly and differently on each engine during acceleration for takeoff. The number one fan never reached targeted N1 speed, but engine performance appeared normal and balanced during reverse thrust. Examination at the scene and during teardowns showed no pre-existing engine damage. Also, the DFDR's N1 values as a function of fuel flow closely matched those for an average engine.

The loud "bang" on the CVR could have been a compressor surge, but engine parameters had no sharp discontinuities. Also, parameters recorded during the accident airplane's 10 previous takeoffs showed both engines accelerating together with standard autothrottle characteristics.

The Safety Board believes that the captain either did not rearm the autothrottle after the inadvertent disengagement or he did not rearm and press TO/GA before 64 knots was reached. In either case, the autothrottles did not engage. The first officer did a "rough manual power set," but the captain did not make final adjustments to the left throttle. The left engine never reached its targeted N1, explaining substandard engine performance compared to a typical autothrottle thrust application.

## 2.9 The "Bang" and Rumble on the CVR

The tire marks on the runway suggest that the captain's continued attempt to steer using the nosewheel caused the "bang" and rumble noises that prompted the RT0. Rumbling began when Flight 5050 reached 95 knots ground speed 1,736 feet from the start of runway 31. The "bang" was most likely caused by the left nosewheel tire suddenly coming off the rim allowing the air to escape violently.

The CVR shows that 23 seconds elapsed after the takeoff started before the rumble started. During this period, the rudder was deflected to the left much of the time. The Safety Board believes that Flight 5050 stayed on the runway, instead of running off the left side of the runway, because the captain was overpowering the rudder by commanding the nosewheel to steer right with the tiller. Erasure marks on the runway and damage to the nose tires confirm this.

## 2.10 Crew Coordination

### 2.10.1 Cockpit Resource Management Training

The Safety Board views the absence of a comprehensive departure briefing, the absence of airspeed callouts, the failure of the first officer to clearly communicate his directional control problem, and the non-assertive manner in which the captain communicated his intent to reject the takeoff as indications of poor cockpit coordination. That the pilots of flight 5050 were ineffective as a team is probably the result, in part, of their lack of any formal training on cockpit resource management (CRM). Both of the flight crewmembers were hired and trained by Piedmont Airlines before the merger with USAir had been completed. Piedmont Airlines did not provide formal CRM management training to either pilot involved in this accident.

FAA Advisory Circular 120-51 issued on December 1, 1989, states that CRM training should consist of (1) definition and discussion, (2) practice and feedback especially by line-oriented flight training (LOFT) and (3) continuous reinforcement as part of the airline's culture. At the time of the accident, USAir had 1 1/2 days of CRM training spent mostly on awareness. Out of 6,000 pilots about 1,800 had been exposed to this training, and neither the captain nor the first officer of Flight 5050 were among them.



The following are crew coordination problems evident in the accident sequence:

- 1) the captain's failure to provide an extended briefing, or an emergency briefing, before the takeoffs at BWI and LGA or at any time during the 9 hours the crewmembers spent together before the accident;
- 2) the decision of the captain to execute the takeoff at LGA with autobrakes disengaged, contrary to company and manufacturer recommendations;
- 3) the failure of the crew to detect the improper rudder trim setting in response to the checklists;
- 4) the failure of the crew to detect the improper rudder trim setting by means of rudder pedal displacement information during taxiing and holding for takeoff;
- 5) the failure of the aircraft to hold at **taxiway GOLF GOLF** during taxiing as directed by ATC (this error, an obvious violation, had no effect on the accident sequence);
- 6) the failure of the first officer to push the correct button to engage the autothrottles at the beginning of the takeoff roll;
- 7) the failure of the captain, during the takeoff roll, to take control of the aircraft and transfer control back to the first officer in a smooth and professional manner, with the result of confusion as to who was in control;
- 8) the failure of the captain to make speed call outs and to consult airspeed before initiating an abort;
- 9) the failure of the captain to announce the abort decision in standard terminology, with the result of confusion by the first officer as to what action was being taken;
- 10) The failure of the captain to execute the abort procedure in a rapid and aggressive manner.

The Safety Board believes that giving CRM training of the sort described by the FAA Advisory Circular to all pilots can prevent the type of cockpit coordination and communication difficulties evident on flight 5050. Although the circular was only advisory and was issued after the accident, the Safety Board believes that agreement on the value of CRM was widespread enough that **USAir** should have had better CRM training in place.

According to the author of the FAA's report of its latest inspection of **USAir**, **USAir** was making changes recommended by the FAA to improve the communication, coordination, and the adherence to required procedures by its flightcrews.

#### 2. 10. 2 Pre-takeoff Emergency Procedures Briefings

The Safety Board concludes that the captain's briefing on departure and emergency procedures was not adequate for the circumstances of this takeoff. Before boarding the airplane at BWI, he learned that the first officer was on his first trip after obtaining initial operating experience in the B-737. Having never flown with the first officer before, the captain could not have been fully aware of his capabilities. Thus, the captain should have given more than the minimal briefing that he provided prior to departure from BWI.

At **LaGuardia**, the captain should have been even more aware that the first officer needed a discussion of emergency procedures, such as rejected takeoffs. LGA was to be the first officer's first non-supervised takeoff in line operational status. Conditions included darkness, low ceiling, and a wet runway that was also relatively short with no appreciable overrun, having water at its end. The Safety Board believes that these factors categorized the takeoff as nonroutine and should have prompted the captain to review rejected takeoff procedures with the first officer. **USAir** does not require a discussion of emergency procedures during departure briefings. In this case, however, good airmanship dictated such a discussion. The captain might even have accomplished the takeoff himself since the first officer lacked experience in the B-737 under such conditions.

#### 2. 10. 3 Crew Coordination During the Takeoff Run

Critical lack of crew coordination was obvious when the aircraft began to veer left as it accelerated for takeoff. The CVR recorded the captain talking about steering twice during the takeoff. According to the captain, his first statement meant that he was taking charge of directional control using the nosewheel tiller, and the second meant that he was giving responsibility for directional control back to the first officer. According to the first officer, the first statement meant that the captain was taking over steering and the second was to confirm this and to remind the first officer to leave the rudder pedals alone. The expression "got the steering" was probably ambiguous to the first officer because the captain might have been taking charge of the entire takeoff or just the steering. In any case, data from the DFDR make clear that both pilots were attempting to maintain directional control at one time and neither was steering at another. Also, no one was making required speed callouts; consequently, the captain may not have realized that he had reached VI speed when he decided to reject the takeoff. The aircraft was accelerating so rapidly that although the decision to reject the takeoff may have been at or below  $V_1$ , slowing of the aircraft did not begin until five knots over the maximum safe RTO speed.

The Safety Board believes that the captain should have used his command authority to take full control as soon as the first officer's control difficulty became apparent. Then he could have made an informed decision to either reject or continue the takeoff. Being aware of the first officer's inexperience and his own inexperience as a captain, he should have been mentally prepared to assume full control early, rather than to merely assist the first officer.

When the captain finally rejected the takeoff, he used the phrase "let's take it back," a non-standard expression not recognized by the first officer as announcement of a rejected takeoff. The first officer expected to continue the takeoff up until the captain retarded the throttles. **USAir** calls for the captain to announce an abort with the word "reject." The ambiguous "let's take it back" could mean many things. High-speed rejected takeoffs are statistically one of the most dangerous maneuvers ever faced by captains and demand clear, concise communications.

#### 2.10.4 Pilot Experience and Pairing

The facts, conditions, and circumstances of this accident further reinforce the Safety Board's belief that the pairing of pilots with limited experience in their respective positions can, when combined with other factors, such as an aircraft anomaly, be unsafe and is not acceptable. The Safety Board believes that although the pilots of flight 5050 had previously demonstrated competence in their duties, compromises in the captain's decision-making processes and management of the flight, and the first officer's improper operation of aircraft controls occurred as a result of inexperience in their respective positions. The Safety Board also continues to believe that an operational safeguard to reduce the effect of these circumstances would be to establish a requirement prohibiting the scheduling or pairing on the same flight of crewmembers with limited experience in their respective positions.

Although the FAA originally disagreed with an earlier Safety Board recommendation (A-88-137) calling for such crew pairing requirements, the Safety Board is encouraged by the FAA's efforts to solicit industry recommendations on the subject. However, it remains concerned that repeated accidents over several years have shown current Federal regulations on air carrier crew operating experience to be inadequate. Given the normal time required to amend these regulations, it is likely to be several more years before suitable requirements are in effect.

Therefore, the Safety Board continues to believe that the FAA should initiate rulemaking, on an expedited basis, to establish experience levels for each pilot-in-command and second-in-command pilot, and to prohibit the pairing on the same flight of pilots who have less than the specified minimum experience in their respective positions. Based on FAA's recent actions and apparent commitment to work toward rulemaking on this issue, the Safety Board has classified Safety Recommendation A-88-137 "Open-Acceptable fiction."

The Safety Board supports the intent of the Crew Pairing Committee recommendations concerning the consolidation of pilots' recently-acquired training. However, it is concerned that completion of the specified of line operating time over a **120-day** period may not provide a regular and concentrated exposure to achieve the desired effect. Moreover, newly-trained air carrier pilots normally are initially scheduled on "reserve" or on an "on-call" basis and, as a result, may not fly at regular and frequent intervals. This irregularity of exposure also could detract from the intended consolidation of learning. Accordingly, the Safety Board believes that the FAA should urge air carriers to schedule newly-trained captains and first officers on regular trip sequences immediately following the training session, until they accrue a prescribed amount of line operating time in their respective positions, in order to consolidate their recently-acquired training.

In view of the circumstances of this accident, the Safety Board believes that the crew pairing minimum flight hour limitation, including IOE, should not be less than 150 hours. Furthermore, the Safety Board believes operators should be required to pair not only a captain who has a relatively high level of experience with a first officer of relatively low level of experience, but also should require that a captain with relatively low level of experience be scheduled with a first officer with relatively high level of experience. In this manner, flight crewmembers' relative experience levels would complement and compensate one another rather than counteract one another, as illustrated by this accident. Therefore, the Safety Board believes the FAA should amend the air carrier regulations to specify a combined experience level for initial pilot-in-command and initial **second-in-command** pilots which would preclude the pairing of two pilots, each of whom has relatively low experience in his or her respective position.

## 2.11 Making Runway Overruns Safer

While strongly advocating runway safety areas and paved overruns where practical, the Safety Board does not cite the lack of a sufficient overrun or safety area as a factor in this accident because flight 5050 could have legally taken off from a runway less than 5000 feet long. Runway 31 is 7,000 feet long. So the effective overrun, then, was more than 2,000 feet. Nonetheless, other airplanes routinely depart LGA under conditions that require the entire 7,000 feet of runway surface for acceleration and stop in event of a takeoff rejected near **V<sub>1</sub>** speed.

Although the overrun safety area for runway 31 at **LaGuardia** was only 100 feet long and extended over **Bowery** Bay on a pier, it met FAA certification standards because the rules in effect when runway 31 was extended in 1965 and 1966 did not require runway overrun safety areas. Further, rule changes made **since the** extension of runway 31 have exempted existing runways at FAA-certificated airports from requirements for overrun safety areas unless significant extension of a runway is planned and construction of the safety area is economically feasible and practical.

Furthermore, the Safety Board is concerned that with recent emphasis on improving and de-lethalizing areas beyond the runway, including

the replacement of rigid supports for approach light systems with frangible supports, more attention was not given to runway 31 at LaGuardia. For N416US, conditions included a precipitous drop of about 15 feet into the water of Bowery Bay followed by collisions with the massive wood and concrete stanchions that supported the approach lights for runway 13.

Although the provision of a longer overrun safety area northwest of the departure end of runway 31 may not be economically feasible or practical under the existing circumstances, the Safety Board believes that it might be possible to eliminate some of the existing hazards. For example, it might be feasible to provide a gradually sloping ramp from the end of the overrun to the water and to replace the existing approach light stanchions with less massive or frangible stanchions. The impact from the existing elevated platform and the massive stanchions ruptured the fuselage of N416US, killing the occupants of seats 21A and 21B and trapping two other passengers nearby. Moreover, had the airplane contained the number of passengers it was capable of accommodating, it is likely that many more serious injuries and deaths would have occurred. Therefore, the Safety Board believes that the Port Authority of New Jersey and New York should consider improvements in the area beyond the departure end of runway 31, and the areas beyond the departure ends of the other runways at LGA containing similar hazards, to reduce the risk to passengers of airplanes that leave the end of the runways at low to moderate speeds.

## 2.12 Survival Factors

The impact of the airplane with the pier and water generated minor overall forces because of the low speed when the airplane departed the runway. However, at seat rows 4 and 21, the fuselage received localized severe vertical forces where the approach light pier structure penetrated and separated the lower fuselage. The floor crushed upward at seat rows 21 and 22 and trapped four passengers. The passengers in 21A and 21B were trapped in seats that were crushed against the ceiling; they died of asphyxia from compression of their chests. Only immediate extraction and life support would have saved them. The other two passengers, in seats 22F and 21A, sustained serious multiple injuries.

Megaphones -- Megaphones are required safety equipment aboard aircraft and should be capable of operating after a survivable accident, including those in the water. In this case, although the megaphone was not recovered, it may have been a model on which the volume knob rotated opposite to conventional volume knobs. This could explain the feedback experience by the lead flight attendant. In addition, it failed after it got wet. The FAA has no Technical Standards Order (TSO) or other standard for the design, construction, and operation of megaphones, and the Safety Board believes that the FAA should develop such a TSO.

Flotation Equipment -- Flight 5050 was not equipped for extended overwater operations defined by 14 CFR 1.1 because it was never to be more than 50 nautical miles from the nearest shoreline. Passengers had to make use of flotation seat cushions, even though the flight and cockpit crewmembers had life preservers. Although no water-related fatalities

resulted from this accident, flotation **cushions** are inadequate substitutes for life preservers, especially for infants, handicapped persons, and other injured persons.

On June 12, 1985, the Safety Board recommended that the FAA require life preservers on flights that operate under 14 CFR 121, 125, and 135. The FAA answered with a Notice of Proposed Rulemaking, and on November 28, 1988, the Safety Board determined that the proposed rule would satisfy its intent. The Safety Board now urges the FAA to expedite final rulemaking.

Flight Attendant Training. -- Water survival training for the flight attendants did not include, and the FAA did not require, hands-on "wet" drills. In response to Safety Board recommendation A-85-49 on July 2, 1985, the FAA issued an Air Carrier Operations Bulletin promoting but not requiring "wet" drills. The Safety Board believes that an **ACOB** falls far short of what will correct this shortcoming in flight attendant training. Unless required to do so, airlines are highly unlikely to develop and use water training facilities, given the initial expense, maintenance costs, and additional training time. Because regulation is needed, the Safety Board reiterates recommendation A-85-49.

Flight Attendant Activities. -- The four flight attendants performed in an outstanding manner following the impact and during and after the evacuation. They assessed the outside conditions, threw seat cushions to passengers, and gave commands that resulted in a timely evacuation. Assessing outside conditions proved to be quite difficult because of darkness.

The flight attendants immediately reacted when they realized that the take-off was deteriorating. As the airplane departed the runway's deck, they told the passengers to brace. As soon as the airplane came to rest, they independently assessed their assigned exit and initiated, as appropriate for their exit, an evacuation. The B and D flight attendants assessed 2L and 2R and saw that water was at those exits but less water was at 2R. The 8 flight attendant knew that an inflated slide would float, rise into the door opening, and block the exit. Her quick thinking and ability to take the initiative under very trying circumstances resulted in her decision to disarm the slide at 2R prior to opening the door. She prevented the exit from becoming unusable and thereby expedited the evacuation.

During the time that passengers were in the water, flight attendants remained in control of the situation by instructing everyone to stay in groups and to help each other. In spite of the strong water current that made it difficult for survivors to stay afloat, flight attendants B and C linked arms to support two passengers who could not swim.

Emergency Response and Water Rescuations. -- The rescue and firefighting response was timely and effective overall; however, several deficiencies were noted; most of which have been corrected. Appendix E contains a synopsis of actions taken by the LGA airport since the accident.

The Safety Board believes that after an accident the airline involved should be responsible for providing rescue officials a timely and accurate list of the numbers of all persons on board. Further, the airline should provide assistance in determining the disposition of persons rescued, killed, or injured.

#### 2.13 Postaccident Toxicological Testing

Because the FAA's rules requiring post-accident toxicological testing of flightcrews was not in effect at the time of the accident, the flightcrew was not required to provide any specimens for testing for drugs. Even if the rules had been in effect, they do not require testing for alcohol. Further, because current FAA rules require the collection of urine specimens only, and allow up to 32 hours for the collection, rules for post-accident testing are inadequate to determine if a flightcrew was impaired and if drugs were causal to an accident. The Safety Board has made recommendations to the Secretary of the U. S. Department of Transportation to set consistent rules for all modes of transportation. Such rules would provide for the postaccident/postincident collection of blood specimens within 4 hours and for tests for a wider group of drugs, including alcohol. Moreover, they would facilitate a determination of the role (or non-role) of drugs and alcohol in accidents and incidents. The Safety Board will continue to seek cooperation from the Department of Transportation in achieving this important goal.

#### 2.14 Postaccident Aircrew Availability

The Safety Board is extremely concerned that no federal investigators were allowed to speak to the pilots of flight 5050 until almost 40 hours after the accident. Specific requests to USAir and ALPA to interview the pilots and to have them provide toxicological samples were made about ten hours and again about 20 hours after the accident. USAir representatives stated they did not know where the pilots were sequestered. The Air Line Pilots Association representatives initially stated that they also did not know where the pilots were, then later stated that their location was being withheld so they could not be found by the media. This complicated the investigative process to a great degree. The sequestering of the pilots for such an extended period of time in many respects borders on interference with a federal investigation and is inexcusable.

More importantly however, is the fact that the pilots may have had safety-related information concerning the Boeing 737-400 that needed to be disseminated to all operators and the Boeing company immediately. This was not the case in this particular accident, but until the pilots were interviewed 40 hours later, only the pilots and their union representatives knew this to be a fact. The Safety Board believes that all parties to an accident investigation have a duty to assure that the safety of the travelling public is given top priority in the earliest phases of the investigation and that they cooperate fully in making those individuals who might possess essential information available as soon as possible. No single party is able to determine whether the information possessed by crew members,

air traffic controllers, witnesses, or others associated with an accident can contribute to the identification of urgently needed corrective actions.

### 3. CONCLUSIONS

#### 3.1 Findings

1. The flight and cabin crews were properly certificated and qualified for the flight.
2. The airplane was certificated, equipped, and maintained in accordance with Federal regulations and approved procedures.
3. Rudder trim moved full left while the airplane was parked with engines off at LGA.
4. The captain could have detected the **mistrim** rudder condition during taxi, during the flight control freedom-of-movement check and during the response to a checklist challenge. He failed to do so.
5. The captain did not use the autobrake system during the takeoff roll, as recommended by Boeing and **USAir** management. His failure to do so delayed the onset of maximum braking and extended the airplane's stopping distance.
6. Both pilots were relatively inexperienced in their respective positions. The captain had about 140 hours as a B-737 captain, and the first officer was conducting his first **non-supervised** line takeoff in a B-737, and also his first takeoff after a 39-days non-flying period.
7. Early in the takeoff attempt, the first officer inadvertently disarmed the autothrottle. He then manually advanced the throttles; the resultant delay and the slightly low thrust set on the left engine lengthened the airplane's ground roll and added to the directional control problem.
8. The captain's use of the nosewheel steering tiller during the takeoff roll was not proper and may have masked the initial directional control problem created by the **mistrimmed** rudder.
9. Because of poor communication between the pilots, both attempted to 'maintain' directional control initially and neither was fully in control later in the takeoff, compounding directional control difficulties.
10. Neither pilot was monitoring indicated airspeed and no standard airspeed **callouts** occurred.



11. *The captain should have been aware of the directional control problem and should have initiated an RT0 before accelerating to high speed.*
12. *Unusual noise and vibration from the cocked nosewheel, and the **leftward** veer, led the captain to reject the takeoff.*
13. *Computed **V<sub>1</sub>** speed was 125 knots and action by the captain to reject the takeoff began at 130 knots.*
14. *After initiating the RT0, the captain used differential braking to steer the airplane. This delayed the attainment of effective braking until 5 1/2 seconds after the takeoff was rejected.*
15. *Braking during the RT0 was less than the maximum braking achievable on the wet runway; the airplane could have been stopped on the runway.*
16. *The airplane departed the end of the runway at about 34 knots.*
17. *The pilots did not submit urine samples for toxicological testing until 44 hours after the accident. They refused to submit blood samples upon the advice of their attorney, in spite of requests to do so by the NTSB.*
18. *FAA requirements for post-accident toxicological testing were not in effect at the time of the accident and the flightcrew was not required to provide specimens for such testing. However, the FAA rules later adopted are inadequate to determine impairment from drugs and alcohol because they permit up to 32 hours for specimen collection and do not include requirements for alcohol tests.*
19. *The low-impact velocity resulted in very low longitudinal acceleration, although high localized vertical forces were experienced at seat rows 4 and 21 where the fuselage crushed when it came to rest on top of the approach light piers.*
20. *The accident was not survivable for the occupants of seats 21A and 21B because of the massive upward crush of the cabin floor.*
21. *The B flight attendant quickly assessed the situation and disarmed the R-2 slide because she anticipated that the inflated slide would have floated on the water and blocked the exit.*

22. *Because the airplane was not required to be equipped with passenger life preservers, crewmembers threw life preservers and flotation seat cushions to persons in the water. However, the flotation cushions were difficult to hold and did not provide adequate flotation.*
23. *The portable cabin megaphone was not waterproof, and it may have had a volume control knob that operated contrary to established ergonomic principles; the FAA has no Technical Standards Order regarding the design, construction and operation of portable cabin megaphones.*
24. *The FAA did not require the flight attendants to receive "hands-on" water ditching training, which would have better prepared them for an unplanned water landing.*
25. *The airport's boat could not be launched, and the first boats did not arrive until about 10 minutes after the accident at which time passengers had drifted under the dark runway deck, further hampering their rescue.*
26. *The flight attendants performed admirably in warning passengers of the impending impact, maintaining control during the evacuation, throwing flotation devices to passengers in the water, and holding passengers who could not swim and who had difficulty staying afloat.*

### 3.2 Probable Cause

*The National Transportation Safety Board determines that the probable cause of this accident was the captain's failure to exercise his command authority in a timely manner to reject the takeoff or take sufficient control to continue the takeoff, which was initiated with a mistrimmed rudder. Also causal was the captain's failure to detect the mistrimmed rudder before the takeoff was attempted.*

#### 4. RECOMMENDATIONS

As a result of this investigation, the National Transportation Safety Board made the following recommendations:

--to the Federal Aviation Administration:

*Develop standards for the design, construction, operation, and performance of megaphones. (Class II, Priority Action) (A-90-104)*

*Require airlines to provide airport crash/fire rescue personnel accurate and timely numbers of all persons aboard an accident/incident aircraft, and to provide assistance in determining the disposition of persons who have been recovered from the scene of an accident. (Class II, Priority Action) (A-90-105)*

*Require air carriers to adopt procedures that would result in the completion of a modified or full acceptance checklist whenever the flightcrew has vacated the cockpit. (Class II, Priority Action) (A-90-106)*

*Issue an Air Carrier Operations Bulletin directing all Principal Operations Inspectors to urge air carriers to schedule newly-trained captains and first officers on regular trip schedules immediately following completion of training, until they accrue a prescribed amount of line operating time in their respective positions in order to consolidate their recently-acquired training. (Class II, Priority Action) (A-90-107)*

*Amend 14 CFR 121.385 to specify a combined experience level for initial pilot-in-command and initial **second-in-command** pilots which would preclude the pairing of two pilots, each of whom has relatively low experience in his or her respective position. (Class II, Priority Action) (A-90-108)*

--to the Port Authority of New York and New Jersey:

*Survey the 1,000 foot by 500 foot surface area contiguous to the departure ends of the runways at the **LaGuardia** Airport in order to minimize hazards to airplanes that do not stop on the runways. (Class II, Priority Action) (A-90-111)*

The Safety Board reiterated the following recommendation to the Federal Aviation Administration:

Amend 14 CFR 121, 125, and 135 to require that cockpit and cabin crewmembers on aircraft being operated under these Parts be given periodic training, including hands-on "wet" drills, in the skills relevant to inadvertent water impact that may increase the chances of post-crash survival. (Class II, Priority Action) (A-85-49)

As a result of the Safety Board's Special Investigation Report SIR-90-02: Runway Overruns Following a High Speed Rejected Takeoffs, the Safety Board issued the following recommendations pertinent to this accident:

Redefine VI in 14 CFR 1.2 and 14 CFR 25.107 (2) to clearly convey that it is the takeoff commitment speed and the maximum speed at which rejected takeoff action can be initiated to stop the airplane within the accelerate-stop distance. (Class II, Priority Action) (A-90-40)

Require Principal Operations Inspectors to review the accuracy of information on VI and rejected takeoffs that 14 CFR 121 operators provide the flightcrews to assure that they provide correct information about pilot actions required to maximize the stopping performance of an airplane during a high speed rejected takeoff. (Class II, Priority Action) (A-90-41)

Require 14 CFR 121 operators to present to flightcrews the conditions upon which flight manual stopping performance is predicated and include information about those factors which adversely affect stopping performance. (Class II, Priority Action) (A-90-42)

Require that simulator training for flightcrews of 14 CFR 121 operators present, to the extent possible, the cues and cockpit warnings of occurrences other than engine failures that have frequently resulted in high speed rejected takeoffs. (Class II, Priority Action) (A-90-43)

Require that simulator training of 14 CFR 121 operators present accurately the stopping distance margin available for a rejected takeoff initiated near or at  $V_1$  on runways where the distance equals or just exceeds balanced field conditions. (Class II, Priority Action) (A-90-44)

Require that simulator training for flightcrews of 14 CFR 121 operators emphasize crew coordination during rejected takeoffs, particularly those rejected takeoffs that require transfer of control from the first officer to the captain. (Class II, Priority Action) (A-90-45)

Require 14 CFR 121 operators to review their policies which permit first officers to perform takeoffs on contaminated runways and runways that provide minimal rejected takeoff stopping distance margins, and encourage the operators to revise those policies as necessary. (Class II, Priority Action) (A-90-46)

Require that the takeoff procedures of 14 CFR 121 operators are standardized among their airplane types of the extent possible, and that the procedures include appropriate **callouts** to alert flightcrew members clearly and unambiguously when the airplane is entering the high speed takeoff regime and when a rejected takeoff is being initiated. (Class II, Priority Action) (A-90-47)

Require 14 CFR 121 operators to require pilots to adopt a policy to use the maximum brake capability of autobrake systems, when installed on the airplane, for all takeoffs in which runway conditions warrant and where minimum stopping distances are available following a rejected takeoff. (Class II, Priority Action) (A-90-48)

BY THE NATIONAL TRANSPORTATION SAFETY BOARD

*/s/* James L. Kolstad  
Chairman

*/s/* Susan Couahlin  
Vice Chairman

*/s/* John K. Lauber  
Member

*/s/* Jim Burnett  
Member

Jim Burnett, **Member**, filed the following concurring and dissenting statement:

Although I concur with the probable cause as adopted as far as it goes, I would have added the following as a contributing factor: Contributing to the cause of the accident was the failure of **USAir** to provide an adequately experienced and seasoned flight crew.

July 3, 1990

## 5. APPENDIXES

## APPENDIX A

## INVESTIGATION AND HEARING

## 1. Investigation

*The National Transportation Safety Board was notified of the accident at about 0100 on September 21, 1989. An investigation team was dispatched from Washington, D. C., at about 0600 and arrived on scene about 1 hour later. Investigative groups were formed for operations, air traffic control, meteorology, human performance, survival factors, structures, systems, powerplants, and maintenance records. Groups were later formed for aircraft performance and for readout of the CVR and DFDR in Washington, D. C.*

*Parties to the investigation included USAir, Inc., the FAA, CFM International/General Electric Aircraft Engines, the Boeing Aircraft Group, the Air Line Pilots Association, the Association of Flight Attendants, the International Association of Machinists, and the Port Authority of New York and New Jersey.*

## 2. Public Hearing

*A public hearing on this accident was held in New York City on February 13-16, 1990.*

## APPENDIX B

## PERSONNEL INFORMATION

*Captain Michael Martin*

*Captain Martin, 36, held Airline Transport Pilot certificate 243378065 with endorsements for the deHavilland DH-4 and the Boeing 737. He also had multiengine commercial and single engine land ratings, along with a turbojet flight engineer certificate. He was issued an FAA first class medical certificate with no limitations on May 17, 1989. The captain was hired by Piedmont Airlines on July 9, 1984. He had a total estimated flying time of 5,525 hours, 1,500 hours of which were in the USAF and USAF Reserve.*

*First Officer Constantine Kleissas*

*First Officer Kleissas, 29, held Airline Transport Pilot certificate 572317704 with commercial multiengine land and single engine land and sea ratings. He was issued an FAA first class medical certificate with no limitations on April 12, 1989. He had a total flying time of 3,287 hours.*

*Flight Attendant Wayne Reed*

*Flight Attendant Wayne Reed, 34, was the senior flight attendant. He was employed by USAir on April 30, 1985, and had been a full time flight attendant for 4 years and months. His most recent recurrent training was successfully completed on April 25, 1989. He occupied the jumpseat at door 1-Left (1-L)*

*Flight Attendant Kelly Donovan*

*Flight Attendant Kelly Donovan, 31, was employed by USAir on July 2, 1987, and had been a full-time flight attendant for 2 years and 2 months. Her most recent recurrent training was successfully completed on June 6, 1989. She occupied the jumpseat at door 2-Left (2-L).*

*Flight Attendant Susan Harelson*

*Flight Attendant Susan Harelson, 24, was employed by USAir on July 2, 1987, and had been a full-time flight attendant for 2 years and 2 months. Her most recent recurrent training was successfully completed on June 6, 1989. She occupied the jumpseat at door 1-Right (1-R).*

*Flight Attendant Jolynn Galmi sh*

*Flight Attendant Jolynn Galmi sh, 23, was employed by USAir on June 14, 1987, and had been a full-time flight attendant for 2 years and 3 months. Her most recent recurrent training was successfully completed on June 24, 1989. She occupied the jumpseat at door 2-Right (2-R).*

## APPENDIX C

## AIRPLANE INFORMATION

Boeing 737-400, **N416US**, was delivered to Piedmont Aviation on December 23, 1988. At the time of the accident, the airplane was owned and operated by **USAir, Inc.** The airplane had accumulated 2,236 hours and 1,730 cycles. It was equipped with two CFM International CFM-56-32B engines.



## APPENDIX D

## COCKPIT VOICE RECORDER TRANSCRIPT

TRANSCRIPT OF A FAIRCHILD MODEL A-100 COCKPIT VOICE RECORDER S/N 6128 REMOVED FROM A USAIR AIRLINES BOEING 737-400 WHICH WAS INVOLVED IN A TAKEOFF ACCIDENT ON SEPTEMBER 20, 1989 AT NEW YORK LAGUARDIA INTERNATIONAL AIRPORT, NEW YORK

*CAM* Cockpit area microphone voice ' or sound source

*RDO* Radio transmission from accident aircraft

*PA* Aircraft Public Address System Source

*INT* Cockpit to Ground Intercom System

*-1* Voice identified as Captain

*-2* Voice identified as First Officer

*-3* Voice identified as Ground Mechanic

*-?* Voice unidentified

*TWR* Laguardia Local Controller (Tower)

*GND* Laguardia Ground Controller

*OPS* USAir Operations at Laguardia

*UNK* Unidentifiable Radio Transmission

*\** Unintelligible word

*@* Nonpertinent word

*#* Expletive deleted

*%* Break in continuity

*O* Questionable text

*(( ))* Editorial insertion

Pause

*NOTE:* All times are expressed in Eastern Daylight Savings Time. Only radio transmissions to or about the accident aircraft were transcribed.

**INTRA-COCKPIT****TIME &  
SOURCE****CONTENT**

*Start of recording*

**2249:30**

*CAM-1 okay I'm tired of # around*

**2249:31**

*CAM-2 all right*

**2249:33**

*CAM-1 we're supposed to be out of here at ah*

**2249:35**

*CAM-2 oh you mean on the original printed schedule*

**2249:38**

*CAM-1 five six seven eight nine*

**2249:41**

*CAM-1 It's almost eleven now*

**2249:43**

*CAM-2 that's correct ten to eleven*

**2249:45**

*CAM-1 ### we couldn't wait any longer*

**2249:47**

*CAM-2 ah I don't know what they're thinking*

**2249:52**

*CAM-2 okay*

**2250:00**

*CAM-2 okay packs off forty PSI*

**AIR-GROUND COMMUNICATIONS****TIME &  
SOURCE****CONTENT**

IRTRA-COCKPIT

TIME &  
SOURCE                      CONTENT

**2250:07**  
CAM-1 you know sorry about the people in Greensboro  
but # i l man I just can't go stop In Greensboro

2250: 14  
INT-1 you still on

**2250:16**  
INT-3 okay \*

**2250:24**  
CAM-1 you got a push back in there

**2250:25**  
CAM-2 ah yes sir and we're gonna be towed forward  
to spot one

**2250:31**  
CAM-1 oh god

**2250:32**  
CAM-2 yeah

**2250:36**  
CAM-2 American behi nd us

**2250:40**  
INT-3 you' re cleared to start now

**2250:41**  
INT-1 okay we need to go to spot one

**2250:43**  
INT-3 understand spot one

AIR- GROUND COMMUNICATIONS

TIME &  
SOURCE                      CONTENT

**INTRA-COCKPIT****TIME &  
SOURCE****CONTENT****2250:45**INT-1 *turning two***2250:50**CAM-1 *go ahead***2250:52**CAM-2 *start valve's open***2250:56**CAM-1 *time is really **gettin' \*\*** bad we were due  
out at sixteen fifty five right***2250:58**CAM-2 *ah originally***2251:02**CAM-1 *that's seventeen hundred that's five o'clock  
my watch says now***2251:05**CAM-2 *you're loo- comin' up on six hours late  
yes sir***2251:08**CAM-1 *see we're runnin' out of time too we  
couldn't wait a minute longer we might  
not even get to Lansing***2251:12**CAM-2 *naw not at this rate***2251:17**CAM-2 *\*\*\****AIR-GROUND COMMUNICATIONS****TIME &  
SOURCE****CONTENT**

**INTRA-COCKPIT**

<b><u>TIME &amp; SOURCE</u></b>	<b><u>CONTENT</u></b>
<b>2251:20</b> CAM-1	<i>we might get to Lansing</i>
<b>2251:21</b> CAM-2	<i>((sound of laugh)) gotta think positive</i>
<b>2251:22</b> CAM-1	<i>we're gonna be # haulin' #</i>
<b>2251:27</b> CAM-1	<i>as long as it gets smooth enroute I'm gonna run your speed up</i>
<b>2251:29</b> CAM-2	<i>what ever you say fifty five •</i>
<b>2251:55</b> CAM-1	<i>da ta da clear one</i>
<b>2252:06</b> CAM-2	<i>okay</i>
<b>2252:07</b> CAM-2	<i>five seventy seven</i>
<b>2252:09</b> CAM-1	<i>another thing too I don't know if they taught you --</i>
2252: 10 INT-3	<i>brakes set please</i>
2252: 15 INT-1	<i>brakes are set</i>

**AIR-GROUND COMMUNICATIONS**

<b><u>TIME &amp; SOURCE</u></b>	<b><u>CONTENT</u></b>
---------------------------------	-----------------------

**INTRA-COCKPIT**

**TIME &  
SOURCE**

CONTENT

**2252:16**

*INT-3 thank you*

**2252:25**

*CAM-1 make sure also ah Connie that when you ah  
you note the pressure when you start is  
the same as it is when you finish at least  
the same*

**2252:32**

*CAM-2 oh okay*

**2252:34**

*CAM-1 - you're **lookin'** for that to go back to forty  
two or so because occasionally you'll get one  
of these -*

**2252:36**

*CAM-2 uh huh*

**2252:37**

*CAM-1 - **the light** stays on and the only way - just a  
**second** - only way to verify if this is **tellin'**  
you the truth or not **is-***

*CAM-2 ah*

**2252:44**

*CAM-1 -did that go back to where it started out at*

*CAM-2 ah*

**5**

**AIR-GROUND COMMUNICATIONS**

**TIM a  
SOURCE**

CONTENT

INTRA-COCKPIT

<u>TIM a</u> <u>SOURCE</u>	<u>CONTENT</u>
<b>2252:46</b> CAM-1	<i>and ah you might save yourself some grief if you're able to tell the captain you <b>flyin'</b> with hey we did get starter cut out I know because it went right back to where it started you always just</i>
<b>2253:05</b> CAM-2	<i>right</i>
<b>2253:06</b> CAM-1	<i>look at the <b>Airbus</b> over there</i>
<b>2253:07</b> CAM-1	<i>ta da</i>
<b>2253:08</b> CAM-2	<i>forty five fifty ah --***</i>
<b>2253:30</b> CAM-1	<i>after start</i>
<b>2253:39</b> CAM-2	<i>electrical panel</i>
<b>2253:41</b> CAM-1	<i>checked set</i>
<b>2253:42</b> CAM-2	<i>okay hydraulics</i>
<b>2253:44</b> CAM-1	<i>on pressure</i>
<b>2253:45</b> CAM-2	<i>engine anti-ice</i>

AIR-GROUND COMMUNICATIONS

<u>TIME a</u> <u>SOURCE</u>	<u>CONTENT</u>
--------------------------------	----------------

**INTRA-COCKPIT**

<b><u>TIME a SOURCE</u></b>	<b><u>CONTENT</u></b>
<b>2253:46</b> CAM-1	off
<b>2253:47</b> CAM-2	air condition ng pressurization
<b>2253:49</b> CAM-1	set
<b>2253:50</b> CAM-2	radar
<b>2253:51</b> CAM-1	standby aux
<b>2253:53</b> CAM-2	okay and door lights and locked
<b>2253:54</b> CAM-1	checked
<b>2253:55</b> CAM-2	okay

**AIR-GROUND COMMUNICATIONS**

<b><u>TIME &amp; SOURCE</u></b>	<b><u>CONTENT</u></b>
<b>2254:01</b> RDO-2	ground USAir fifty fifty taxi
<b>2254:06</b> GND	USAir fifteen fifty eight
<b>2254:08</b> RDO-2	ah five zero five zero spot one with Zulu



8

INTRA-COCKPIT

<u>TIM a</u>	<u>CONTENT</u>
<u>SOURCE</u>	

**2254:30**  
CAM-1 all right

**2254:40**  
CAM-1 okay you need to call 'em back inside  
and tell 'em that our numbers that we  
got on our papers shows zero passengers  
they need to re-figure with fifty five  
passengers

**2254:52**  
CAM-2 okay that's our ops

**2254:53**  
CAM-1 yeah

**2254:55**  
CAM-2 I'm off

**2255:16**  
CAM-2 how many people

**2255:17**  
CAM-1 fifty five

AIR-GROUND COMMUNICATIONS

<u>TIME a</u>	<u>CONTENT</u>
<u>SOURCE</u>	

**2254:10**  
GND ah USAir fifty fifty turn ah right on the  
inner hold short at double golf for runway  
three one

**2254:17**  
RDO-2 okay right on the inner hold short of golf  
golf

**2254:57**  
RDO-2 ops fifty fifty

9

<u>INTRA-COCKPIT</u>	<u>AIR-GROUND COMMUNICATIONS</u>
<u>TIME &amp; SOURCE</u>	<u>TIME &amp; SOURCE</u>
<u>CONTENT</u>	<u>CONTENT</u>
CAM-2 okay	2255:22 RDO-2 ops fifty fifty
	2255:43 RDO-2 operations USAir fifty fifty
	2256:00 GND ah USAir fifty fifty you missed double golf move up on the inner taxi way and hold short of lima now
	2256:07 RDO-1 okay short of lima now fifty fifty five oh five oh
	2256:14 RDO-2 operations USAir fifty fifty
	2256:19 OPS fifty fifty stand-by one
	2256:32 UNK fifty fifty
	2256:42 RDO-2 ops USAir fifty fifty
2256:51 CAM-2 why doesn't this sucker answer	2256:59 RDO-2 operations USAir fifty fifty

INTRA-COCKPITTIME &  
SOURCECONTENT**2257:43**

CAM-2 I can't get anybody to answer he's talk -  
I mean he talks but he just doesn't answer

IO

AIR-GROUND COMMUNICATIONSTIME<sup>a</sup>  
SOURCECONTENT**2257:20**

RDO-2 operations **USAir** fifty fifty

**2257:56**

RDO-2 operations **USAir** fifty fifty how do you hear

**2258:20**

RDO-2 operations **USAir** fifty fifty

2259:00

RDD-2 operations is anybody home fifty fifty

2259:05

**OPS** fifty fifty go ahead this is ops

**2259:07**

RDD-2 hello there ah we're gonna need some new numbers sent out here the numbers you gave us show us as ah zero pax on board we have fifty five

2259:13

**OPS** okay I understand you need new numbers stand-by fifty **fifty**

2259:16

RDD-2 thank you

2259:23

**OPS** ah fifty fifty did you copy

**INTRA-COCKPIT**

<b><u>TIME a</u></b>	<b><u>SOURCE</u></b>	<b><u>CONTENT</u></b>
----------------------	----------------------	-----------------------

2300: 29	CAM-1	<i>did you ever get 'em</i>
----------	-------	-----------------------------

<b>2300:30</b>	CAM-2	<i>yeah he's gonna send them out now I'm back up</i>
----------------	-------	--

<b>2302:06</b>	CAM-2	<i>I'm gettin' it</i>
----------------	-------	-----------------------

<b>2302:07</b>	CAM-1	<i>okay</i>
----------------	-------	-------------

**AIR-GROUND COMMUNICATIONS**

<b><u>TIME a</u></b>	<b><u>SOURCE</u></b>	<b><u>CONTENT</u></b>
----------------------	----------------------	-----------------------

<b>2259:26</b>	RDO-2	<i>ah yes I understand that we're gonna be standin' by for new numbers</i>
----------------	-------	--

2259: 29	OPS	<i>okay I'll send them right out to you sir</i>
----------	-----	---

<b>2259:32</b>	RDO-2	<i>thank you</i>
----------------	-------	------------------

2300: 39	OPS	<i>USAir fifty fifty you copy *</i>
----------	-----	-------------------------------------

<b>2302:25</b>	GND	<i>USAir fifty fifty hold short of taxiway whiskey</i>
----------------	-----	--

<b>2302:28</b>	RDO-2	<i>okay we'll hold short of whiskey fifty fifty</i>
----------------	-------	---

12

**INTRA-COCKPIT**

<b><u>TIME a</u></b>	<b><u>SOURCE</u></b>	<b><u>CONTENT</u></b>
<b>2303:11</b>	CAM-1	<i>let's see what did we do with the Charlotte weather</i>
2303:17	CAM	<i>((sound of six ACARS alert tones))</i>
<b>2303:30</b>	CAM-1	<i>good that's us next page a hundred and seven I was off a little bit</i>
2303:49	CAM-2	<i>here you go</i>
2303:55	CAM-1	<i>ah well we burned down a little fuel</i>
2304:15	CAM-1	<i>ah •</i>
<b>2305:09</b>	CAM-1	<i>what did that guy say do hold short</i>
2305:10	<b>CAM-2</b>	<i>he said hold short of whiskey stay with him</i>
2305:16	CAM	<i>((sound of whistling and humming))</i>

**AIR-GROUND COMMUNICATIONS**

<b><u>TIME a</u></b>	<b><u>SOURCE</u></b>	<b><u>CONTENT</u></b>
<b>2303:01</b>	GND	<i>USAir fifty fifty departure will be one twenty point eight remain with me tentatively number eight</i>
<b>2303:06</b>	RDO-2	<i>roger twenty point eight we copy</i>

**INTRA-COCKPIT****TIME a**  
**SOURCE****CONTENT****2306:14**

CAM-2 *is there a scheduled departure time on this  
you know the estimated time **enroute** --- I  
guess it really doesn't matter*

**2306:30**

CAM-1 *did you put the flight number in there*

**2306:31**

CAM-2 *ah I believe I did let's see here*

**2306:40**

CAM-1 *yeah here it is*

**2306:43**

CAM-2 *ah it screwed up the push back*

**2306:45**

CAM-1 *okay no problem*

**2307:21**

CAM-1 *how long have **we** been here*

**2307:22**

CAR-2 *holding*

**AIR-GROUND COMMUNICATIONS****TIME a**  
**SOURCE****CONTENT****2306:46**

GND

*ah **USAir** fifty fifty hold short of mike  
until advised the setup sequence is the  
**Airbus** on the inner monitor tower one one  
eight seven **ATIS** now is alpha*

**2306:54**

RDO-2

*okay we'll go over to tower at alpha ah go  
behind the **Airbus** at mike*

14

INTRA-COCKPITTIME &  
SOURCECONTENT

2307:39

CAM-1 **hah we're** suppose to be at Lansing in thirty minutes

2307:41

CAM-2 no problem

2307:42

CAM-1 hah

2309:00

CAM-1 say we're six hours late

2309:01

CAM-2 affirmative so it's five o'clock now

2309:06

CAM-1 we had a nine hour thirty minute day

2309:08

CAM-2 yeah I think we're gonna follow him up in front there

2309:09

CAM-1 yeah

2309:15

CAM-1 okay nine hour thirty minute day plus six is what -

2309:18

CAM-2 ah fifteen thirty

CAM-1 **fifteen** thirtyAIR-GROUND COMMUNICATIONSTIME <sup>a</sup>  
SOURCECONTENT

**INTRA-COCKPIT****TIME &  
SOURCE****CONTENT****2309:21**

CAM-1 *good I think we might be inside of sixteen hours*

**2309:31**

CAM-1 *if they jack us around if they try to make us get there w- we'll try to make it if they jack us around we'll we'll slow it down and not make it we'll stop in Dayton -- they'll just have to get somebody else to ah --*

2310:21

CAM-1 *you have a choice to go three hundred or two hundred*

**2310:23**

CAM-2 *ah yeah and ah by the time they got down to us I was number forty in the class all the F-28s went ah senior so ah a few slots left 'em two three hundred slots one two hundred slot the rest all IP's*

**2310:46**

CAM-1 *what's happenin' with the hurricane*

**2310:48**

CAM-2 *I don't know*

**2310:49**

CAM-1 *okay ah but to answer your question I don't know about the ah time --*

2310:55

CAM-2 *screw it on here*

**AIR-GROUND COMMUNICATIONS****TIME &  
SOURCE****CONTENT**



16

**INTRA-COCKPIT****TIME &  
SOURCE****CONTENT****2311:21**CAM-1 *what's it show an hour and eighteen minutes  
enroute***2311:22**CAM-P *that's correct sir***2311:26**CAM-1 *I'll be off for a second***2311:27**CAM-2 *okay***2311:29**CAM *((pa announcement by the captain to the cabin starts))***2312:43**CAM *((end of PA announcement))***2312:51**CAM-1 *back with ya***2312:52**CAM-2 *okay***2312:58**CAM-1 *let's do the before takeoff***2313:04**CAM-2 *fuel quantity***2313:06**CAM-1 *ah checked***AIR-GROUND COMMUNICATIONS****TIME &  
SOURCE****CONTENT**

INTRA-COCKPITTIME &  
SOURCECONTENT**2313:07**CAM-2 *shoul der harness***2313:08**CAM-1 *fastened left***2313:09**CAM-2 *takeoff data***2313:10**CAM-1 *okay it's a hundred and five thousand pound  
machine -at twenty five twenty eight and  
thirty nine*

2313:13

CAM ((sound of ACARS alert beep))

**2313:27**CAM-2 *ah it says somthin' about -***2313:31**CAM-1 *it's still on the ground tell him we're  
gonna be about another ten minutes*AIR - GROUND COMMUNICATIONSTIME &  
SOURCECONTENT**2313:35**RDO-2 *operations it's fifty fifty yes it will be  
about another ten minutes*

2314:13

RDO-2 **USAir** *fifty fifty is still on the ground  
we'll be another ten minutes before  
departure***2314:18**DPS *okay copy that fifty fifty thanks for the  
call*

18

**INTRA-COCKPIT**

<u>TIME &amp; SOURCE</u>	<u>CONTENT</u>
<b>2314:30</b> CAM-2	<i>okay I'm back up with you takeoff data</i>
<b>2314:38</b> CAM-1	<i>yeah speed's checked set twenty five twenty eight thirty nine</i>
<b>2314:43</b> CAM-2	<i>okay stabilizer and trim - I got it</i>
<b>2314:50</b> CAM-2	<i>stabilizer and trim</i>
<b>2314:51</b> CAM-1	<i>set</i>
<b>2314:53</b> CAM-2	<i>flight and stand-by flight instruments</i>
<b>2314:55</b> CAM-1	<i>stabilizer trim I forgot the answer set for takeoff</i>
<b>2314:58</b> CAM-2	<i>okay</i>
<b>2314:59</b> CAM-1	<i>what was the other one</i>
<b>2315:00</b> CAM-2	<i>flight and stand-by flight instruments</i>

**AIR-GROUND COMMUNICATIONS**

<u>TIME &amp; SOURCE</u>	<u>CONTENT</u>
<b>2314:21</b> RDO-2	<i>you bet</i>

**INTRA-COCKPIT**

<b><u>TIME &amp; SOURCE</u></b>	<b><u>CONTENT</u></b>
<b>2315:02</b> CAM-1	<i>they're set</i>
CAM-2	<i>HSI switches</i>
<b>2315:03</b> CAM-1	<i>I got nav up here</i>
<b>2315:05</b> CAM-2	<i>okay ah ice protection</i>
<b>2315:07</b> CAM-1	<i>it's off</i>
<b>2315:08</b> CAM-2	<i>pitot heat</i>
<b>2315:09</b> CAM-1	<i>on and checked</i>
<b>2315:10</b> CAM-2	<i>yaw damper</i>
CAM-1	<i>on and checked</i>
<b>2315:11</b> CAM-2	<i>okay flight controls</i>
<b>2315:12</b> CAM-1	<i>checkin'</i>
<b>2315:14</b> CAM-2	<i>there you go ah flaps</i>
<b>2315:15</b> CAM-1	<i>five five green detent</i>

**AIR-GROUND COMMUNICATIONS**

<b><u>TIME &amp; SOURCE</u></b>	<b><u>CONTENT</u></b>
---------------------------------	-----------------------

20

**INTRA-COCKPIT****TIME &  
SOURCE****CONTENT****2315:16**

CAM-2 APU

**2315:17**CAM-1 *leave it runnin'*

2315: 18

CAM-2 *okay recall*

2315: 19

CAM-1 *checked***2315:20**CAM-2 *departure briefing***2315:21**CAM-1 *your takeoff your brief***2315:22**CAM-2 *okay so it's ah runway heading right turn  
three five zero fer five thousand feet  
Laguardia three departure down to the line***2315:32**CAM-2 *flfty five on board***2315:35**CAM-I *okay***2315:40**CAM ((sound of **ACARS** alert beep))**2315:47**CAM-2 *ah***AIR-GROUND COMMUNICATIONS****TIME &  
SOURCE****CONTENT**

**INTRA-COCKPIT**

<b><u>TIME &amp; SOURCE</u></b>	<b><u>CONTENT</u></b>
<b>2315:49</b>	
CAM-1	<i>see what that is</i>
2315: 53	
CAM-1	<i>new release time</i>
<b>2316:01</b>	
CAM-1	<i>what this</i>
<b>2316:02</b>	
CAM-2	<i>*</i>
2316: 14	
CAM-2	<i>we can ah want tower</i>
<b>2316:17</b>	
CAM-1	<i>I don't exactly remember what he said about tower * what ever</i>
<b>2316:20</b>	
CAM-2	<i>he said ah monitor tower at ah -</i>
<b>2316:22</b>	
CAM-1	<i>yeah yeah</i>
<b>2316:33</b>	
CAM-1	<i>what I usually do too Connie on that release time is just write it on the release I usually just write it ah release time ah is zero three fifteen Shore - the new release time and the dispatcher's name</i>
<b>2316:40</b>	
	<i>((flight switched to tower frequency))</i>

**AIR-GROUND COMMUNICATIONS**

<b><u>TIME &amp; SOURCE</u></b>	<b><u>CONTENT</u></b>
---------------------------------	-----------------------

22

INTRA-COCKPITTIME &  
SOURCECONTENT**2316:55**

CAM-1 *but now what what are they tellin' you hav-  
what paper work are they tellin' you you  
have to turn in*

2316: 58

CAM-2 *ah - just the ah you know the individual flight  
log for each flight number and then at the  
end of the trip the ah that's it*

2317: 13

CAM-1 *they're sayin' just turn in that flight log  
that's all*

2317: 16

CAM-2 *yeah*

**2317:17**

CAM-1 *you don't have to turn in this other stuff*

**2317:18**

CAM-2 *no*

2317: 19

CAM-1 *okay that that's all changed then*

**2317:20**

CAM-2 *oh what*

AIR-GROUND COMMUNICATIONSTIME &  
SOURCECONTENT**2317:04**

TWR

**USAir fifty fifty give way to the Eastern  
Airbus goin' into position and hold short  
caution wake turbulence**

2317: 11

RDO-2

**USAir fifty fifty**

**INTRA-COCKPIT****TIME &  
SOURCE****CONTENT****2317:23**CAM-1 *that that's the new way***2317:24**CAM-2 *ah***2317:25**CAM-1 *with Piedmont we always had to turn in all that other stuff and you you put down th the remarks well you put down dispatch release time and all that gets - the flight manual said you know had to be released every so often -***2317:38**CAM-2 *right***2317:39**CAM-1 *- and you didn't have any record of it now we got ACARS so it'll stay in here so I guess you're probably legal without just writin' it down just a carry over a lot of this stuff you're gonna find is a carry over***2318:01**CAM *((sound of whistling))***AIR-GROUND COMMUNICATIONS****TIME &  
SOURCE****CONTENT**



24

**INTRA-COCKPIT****TIME &  
SOURCE****CONTENT****2318:13**

CAM-1 *I don't know how my fuel keeps getting out of balance it doesn't make any sense at all*

**2318:34**

PA-2 *ladies and gentlemen cleared onto the active runway we'll be departing momentarily flight attendants please be seated*

**2319:40**

CAM-1 *okay below the line*

**2319:41**

CAM-2 *okay got ah start switches are ah*

**2319:46**

CAM-1 *continuous*

**2319:47**

CAM-2 *on continuous out there transponder*

**2319:49**

CAM-1 *on*

**2319:51**

CAM-2 *and the auto-brake*

**AIR-GROUNCOMMUNICATIONS****TIME &  
SOURCE****CONTENT****2318:26**

TWR *USAir fifty fifty caution wake turbulence preceding heavy jet departure taxi into position and hold runway three one*

**2318:31**

RDO-2 *position and hold three one fifty fifty*

**INTRA-COCKPIT****TIME &  
SOURCE****CONTENT**

2319: 53  
CAM-1 *is off*

**2319:54**

CAM-2 *okay takeoff checklist is complete*

**2320:13.3**

CAM-1 *okay*

**2320:15.9**

CAM-1 *you ready for it guy*

**2320:16.7**

CAM-2 *oh here goes nothin'*

**2320:18.9**

CAM-1 *here goes the brakes- lookin' for one  
ah -- no wait a minute what was the #  
weather again --*

**2320:26.0**

CAM-1 *all right make a right turn as soon as you can*

**2320:27.8**

CAM *((sound of increasing engine noise))*

**2320:29.7**

CAM-1 *I got the steering till you ah*

**AIR-GROUND COMMUNICATIONS****TIM &  
SOURCE****CONTENT****2320:05**

TWR *USAir fifty fifty runway three one cleared  
for takeoff caution wake turbulence  
preceding heavy*

**2320:09**

RDO-2 *cleared for takeoff USAir fifty fifty*

**INTRA-COCKPIT****TIME &  
SOURCE****CONTENT****2320:32.1**CAM-2 *okay***2320:32.6**CAM-1 *okay that's the wrong button pushed***2320:34.1**CAR-2 *oh yeah I knew that er***2320:35.5**CAM-1 *It's that one underneath there***2320:41.8**CAM-1 *all right I'll set your power***2320:46.2**CAM *((sound of bang))***2320:50.8**CAM *((sound of loud rumble sound starts))***2320:53.6**CAM-1 *got the steering***2320:54.4**CAM-2 *okay***2320:56.2**CAM-2 *watch it then***2320:58.1**CAM-1 *let's take it back***2320:58.4**CAM *((sound similar to throttles hitting the idle stops))***AIR-GROUND COMMUNICATIONS****TIME &  
SOURCE****CONTENT**

**INTRA-COCKPIT****TIME &  
SOURCE****CONTENT****2321:00.1**

CAM ((rumble sound increases in amplitude))

**2321:00.9**

CAM ((sound of engine noise decreasing))

**2321:07.2**

CAM ((sound of increasing engine sound))

**2321:18.7**CAM-2 ah we' re **goin'** off**2321:20.2**CAM-2 we' re **goin'** off**2321:21.6**CAM-2 we' re **gain'** off**2321:21.9**

CAM ((sound of crash))

**2321:22.8**

((end of recording))

**AIR-GROUND COMMUNICATIONS****TIME &  
SOURCE****CONTENT****2321:07**RDO-2 **USAir** air fifty fifty's aborting**2321:08**TWR **USAir** fifty fifty roger left turn at the end

## APPENDIX D

*Flight Crew's Comments and Additions*A. SUMMARY

The flight crew reviewed the Cockpit Voice Recorder (CVR) transcript on November 16, 1989 in the audio laboratory of the National Transportation Safety Board. The following are their additions and comments to the CVR group's transcript.

B. DETAILS OF INVESTIGATION

Page 1.

At time **2249:52** change CAM-2 to CAM-1.

Page 2.

Change comment at time **2250:31** to "oh gosh".

Page 3.

Change comment at time **2250:56** to:  
CAM-1 time is really get yourself hit bad we were due out at sixteen  
fifty five right

Page 4.

Change comment at time **2251:29** to:  
CAM-2 what ever you say fifty positive N1

Add two comments between time **2251:29** and time **2251:55**  
CAM-1 cut out forty PSIG  
CAM-2 \*\*

Delete "da ta da" on comment at time **2251:55**.

Page 5.

Change word "note" to "know" in comment at time **2252:25**

Change words "; st a second " to "fifty seconds" in comment at time  
**2252:37**

Add comment CAM-2 affirmative after time **2252:37**.

Page 6.

Change comment at time **2253:07** to CAM-1 cut out.

Change comment at time **2253:44** to CAM-1A systems pressured.

Page 8.

Change CAM-1 to CAM-2 at time **2254:30**

- Page 11.  
Change CAM-2 to CAM-1 at time **2302:06**.  
Change CAM-1 to CAM-2 at time **2302:07**.
- Page 12.  
Delete first two (2) words in the comment at time **2303:11**.  
Change "six" to "seven" in editorial comment at time **2303:17**.
- Page 13.  
Change comment at time **2306:40** to read:  
CAM-1 yeah it is  
Delete word "it" from comment at time **2306:43**.  
Add word holding to end of comment at time **2307:21**.  
Delete comment at time **2307:22**.
- Page 15.  
Change word "IP's" to "FE's" in comment at time **2310:23**.
- Page 20.  
Add words "with ah" to the beginning of comment at time **2315:32**.
- Page 21.  
Change word "what" to "what's" in comment at time **2316:01**.
- Page 25.  
Change word "is" to "it's" in comment at time **2319:53**.
- Page 26.  
The Captain thought that the comment-at time **2320:53.6** should read:  
CAM-1 you got the steering  
(The First Officer agreed with the statement as printed)
- Page 27.  
Change CAM-2 to CAM-1 for the comments at times:  
**2321:18.7**  
**2321:20.2**  
**2321:21.6**

## APPENDIX E

SYNOPSIS OF FIRE AND RESCUE CRITIQUES  
AND POST-ACCIDENT IMPROVEMENTS

*The following summarizes topics that were raised during critiques conducted by the Port Authority of New York and New Jersey on September 22, 1989, and by the New York Police Department on September 27, 1989.*

*A serious lack of airport vehicles to escort NYPD and NYFD vehicles from Security Post 3 to the runway. NYPD officers were disoriented because they were not familiar with the airport. The Port Authority responded that they would explore the possibility of new signs to direct emergency vehicles and have updated airport maps sent to commands. Port Authority also encouraged agencies to arrange for airport nighttime familiarization tours. NYFD said that too many people were allowed access to the deck.*

*NYPD Emergency Services questioned why they did not have a reliable passenger manifest and why infants and dead-heading crewmembers were not listed on flight 5050's manifest. A Port Authority representative suggested that the gender of each passenger be listed to help rescuers to account for everyone.*

*On the topic of communications, a NYPD representative asked about using a mobile communications van to assist with interagency communications. A Port Authority captain suggested that in the future each agency should send one person to the on-scene command post and another to the secondary command post in the police garage.*

*A U. S. Coast Guard representative said that his agency needed more guidance on using its boats and helicopters and that the Coast Guard lacked communication with other agencies. The Coast Guard offered to assist in any way possible, including demonstrating flotation devices. The airport manager thanked the Coast Guard for its assistance and said that the agency would be included in future emergency drills at the airport.*

*The Deputy Chief of Operations for Emergency Medical Services said that the EMS staging area at 81st Street and Ditmars Boulevard experienced no difficulty but that there were serious problems trying to stage at the Post 3 security gate. Also, his organization had problems learning where the rescue boats brought people. The Port Authority advised that the problems at Post 3 would be corrected and that updated maps would be provided to the EMS.*

A suggestion was made to place command post flags on telescoping poles to increase their visibility among large ARFF equipment and that Port Authority vehicles be equipped with floatation devices to throw to persons in the water.

The Mayor of New York City commended the firefighting, law enforcement, and rescue personnel for their response. He noted that when he and an aide arrived at the staging area at the Pan American terminal at 0030 there were no airline representatives to care for the 6 to 8 passengers who remained. The mayor and his aide arranged bus transportation and hotel accommodations for the passengers. The mayor's aide said that the Port Authority should have a rescue boat since it took too long for the police and Coast Guard boats to arrive.

The manager of the Airport Services Division at LaGuardia airport testified on February 15, 1990, about several improvements made since the accident, including:

1. The Port Authority bought a new four-wheel drive vehicle to tow the 19-foot Boston Whaler boat they could not use because the police tow vehicle could not get to the boat launch area.
2. On November 18, 1989, the New York City Harbor Patrol, U. S. Coast Guard, and the Port Authority held a water rescue drill.
3. To eliminate confusion about where to bring survivors, the Port Authority designated the Pan Am water shuttle docks as the staging area for this runway.
4. The Port Authority purchased additional personal flotation equipment and installed it on their trucks for throwing to persons in the water.
5. The Port Authority ordered a telescopic light to improve nighttime visibility from the command post, and they are considering a larger command-post vehicle.
6. The Port Authority asked airlines to think about where they want survivors brought.