



# NATIONAL TRANSPORTATION SAFETY BOARD

WASHINGTON, D.C. 20594

## AROCRAFT ACCIDENT REPORT

AMERICAN AIRLINES, INC.,  
DC-10-10, N110AA  
CHICAGO-O'HARE INTERNATIONAL AIRPORT  
CHICAGO, ILLINOIS  
MAY 25, 1979

NTSB-AAR-79-17

C.2

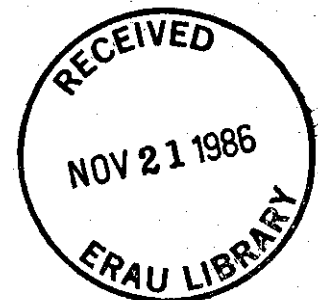

UNITED STATES GOVERNMENT

1. Report No. NTSB-AAR-79-17		2. Government Accession No.		3. Recipient's Catalog No.	
4. Title and Subtitle Aircraft Accident Report- American Airlines, Inc. DC-10-10, N110AA. Chicago-O'Hare International Airport Chicago, Illinois, May 25, 1979				5. Report Date December 21, 1979	
				6. Performing Organization Code	
7. Author(s)				8. Performing Organization Report No.	
9. Performing Organization Name and Address National Transportation Safety Board Bureau of Accident Investigation Washington, D.C. 20594				10. Work Unit No. 2662-E	
				11. Contract or Grant No.	
				13. Type of Report and Period Covered Aircraft Accident Report May 25, 1979	
12. Sponsoring Agency Name and Address  NATIONAL TRANSPORTATION SAFETY BOARD Washington, D. C. 20594				14. Sponsoring Agency Code	
15. Supplementary Notes					
16. Abstract <p>About 1504 e.d.t., May 25, 1979, American Airlines, Inc., Flight 191, a McDonnell-Douglas DC-10-10 aircraft, crashed into an open field just short of a trailer park about 4,600 ft northwest of the departure end of runway 32R at Chicago-O'Hare International Airport, Illinois.</p> <p>Flight 191 was taking off from runway 32R. The weather was clear and the visibility was 15 miles. <u>During the takeoff rotation, the left engine and pylon assembly and about 3 ft of the leading edge of the left wing separated from the aircraft and fell to the runway.</u> Flight 191 continued to climb to about 325 ft above the ground and then began to roll to the left. The aircraft continued to roll to the left until the wings were past the vertical position, and during the roll, the aircraft's nose pitched down below the horizon.</p> <p>Flight 191 crashed into the open field and the wreckage scattered into an adjacent trailer park. The aircraft was destroyed in the crash and subsequent fire. <u>Two hundred and seventy-one persons on board Flight 191 were killed; two persons on the ground were killed, and two others were injured.</u> An old aircraft hangar, several automobiles, and a mobile home were destroyed.</p> <p>The National Transportation Safety Board determines that the probable cause of this accident was the asymmetrical stall and the ensuing roll of the aircraft</p>					
17. Key Words DC-10; loss of control; asymmetrical stall; stall warning system; slat disagreement warning light; structural separation; No. 1 engine and pylon; design criteria; maintenance procedures; FAA regulations; industry communications procedures.				18. Distribution Statement This document is available to the public through the National Technical Information Service, Springfield, Virginia 22151	
19. Security Classification (of this report) UNCLASSIFIED		20. Security Classification (of this page) UNCLASSIFIED		21. No. of Pages 103	
				22. Price	

**(Abstract Cont.)**

because of the uncommanded retraction of the left wing outboard leading edge slats and the **loss** of stall warning and slat disagreement indication systems **resulting from maintenance-induced damage leading to the separation of the No. 1 engine and pylon assembly at a critical point during** takeoff. The separation resulted from damage by improper maintenance procedures which led to failure of the pylon's structure.

Contributing to the cause of the accident were the vulnerability of the design of the pylon attach points to maintenance damage; the vulnerability of the design of the leading edge slat system to the damage which produced asymmetry; deficiencies in Federal Aviation Administration surveillance and reporting systems which failed to detect and prevent the use of improper maintenance procedures; deficiencies in the practices and communications among the operators, the manufacturer, and the FAA which failed to determine and disseminate the particulars regarding previous maintenance damage incidents; and the intolerance of prescribed operational procedures to this unique emergency.

# CONTENTS

Synopsis	.....	1
1.1	History of the Flight	2
1.2	Injuries to Persons	3
Y.3	Damage to Aircraft	3
✓ 1.4	Other Damage	3
1.5	Personnel Information	3
✓ 1.6	Aircraft Information	3
1.7	Metereological Information	3
1.8	Aids to Navigation	3
1.9	Communications	4
1.10	Aerodrome Information	4
1.11	Flight Recorders	4
✓ 1.12	Wreckage and Impact Information	6
1.13	Medical and Pathological Information	11
1.14	Fire	11
1.15	Survival Aspects	11
1.16	Tests and Research	11
1.16.1	Study of Photographs	11
1.16.2	Metallurgical Examinations & Postaccident Inspection DC-10 Fleet	12
1.16.3	Stress Testing of the Pylon Aft Bulkhead	20
1.16.4	Wind Tunnel and Simulator Tests	22
1.17	Other Information	25
1.17.1	Air Carrier Maintenance Procedures	25
1.17.2	FAA Reporting & Surveillance Procedures	31
1.17.3	DC-10 Certification	34
1.17.4	DC-10 Maintenance & Inspection Program	37
1.17.5	Manufacturer's Service Bulletin and Customer Service Program	39
1.17.6	Manufacturer's Production Line Procedures	40
1.17.7	DC-10 Electrical & Hydraulic Systems	42
1.17.8	Flightcrew Procedures	44
2.	Analysis	48
3.	Conclusions	67
3.1	Findings	67
3.2	Probable Cause	69
4.	Safety Recommendations	70
5.	Appendixes	74
	Appendix A--Investigation and Hearing	74
	Appendix B--Personnel Information	75
	Appendix C Aircraft Information	76
	Appendix D Wreckage Diagram	77
	Appendix E Pertinent Airworthiness Regulations	79
	Appendix F Applicable Airworthiness Directives	86
	Appendix G Suspension and Restoration of DC-10 Type Certificate	89
	Appendix H DFDR Readout	98

NATIONAL TRANSPORTATION SAFETY BOARD  
WASHINGTON, D.C. 20594

AIRCRAFT ACCIDENT REPORT

Adopted: December 21, 1979

---

---

AMERICAN AIRLINES, INC.  
DC-10-10, N110AA  
CHICAGO-O'HARE INTERNATIONAL AIRPORT  
CHICAGO, ILLINOIS  
MAY 25, 1979

SYNOPSIS

About 1504 e.d.t., May 25, 1979, American Airlines, Inc., Flight 191, a McDonnell-Douglas DC-10-10 aircraft, crashed into an open field just short of a trailer park about 4,600 ft northwest of the departure end of runway 32R at Chicago-O'Hare International Airport, Illinois.

Flight 191 was taking off from runway 32H. The weather was clear and the visibility was 15 miles. During the takeoff rotation, the left engine and pylon assembly and about 3 ft of the leading edge of the left wing separated from the aircraft and fell to the runway. Flight 191 continued to climb to about 325 ft above the ground and then began to roll to the left. The aircraft continued to roll to the left until the wings were past the vertical position, and during the roll, the aircraft's nose pitched down below the horizon.

Flight 191 crashed into the open field and the wreckage scattered into an adjacent trailer park. The aircraft was destroyed in the crash and subsequent fire. Two hundred and seventy-one persons on board Flight 191 were killed; two persons on the ground were killed, and two others were injured. An old aircraft hangar, several automobiles, and a mobile home were destroyed.

The National Transportation Safety Board determines that the probable cause of this accident was the asymmetrical stall and the ensuing roll of the aircraft because of the uncommanded retraction of the left wing outboard leading edge slats and the loss of stall warning and slat disagreement indication systems resulting from maintenance-induced damage leading to the separation of the No. 1 engine and pylon assembly at a critical point during takeoff. The separation resulted from damage by improper maintenance procedures which led to failure of the pylon structure.

Contributing to the cause of the accident were the vulnerability of the design of the pylon attach points to maintenance damage; the vulnerability of the design of the leading edge slat system to the damage which produced asymmetry; deficiencies in Federal Aviation Administration surveillance and reporting systems which failed to detect and prevent the use of improper maintenance procedures; deficiencies in the practices and communications among the operators, the manufacturer, and the FAA which failed to determine and disseminate the particulars regarding previous maintenance damage incidents; and the intolerance of prescribed operational procedures to this unique emergency.

## 1. FACTUAL INFORMATION

### 1.1 History of the Flight

At 1459 c.d.t.,<sup>1/</sup> May 25, 1979, American Airlines, Inc., Flight 191, a McDonnell-Douglas DC-10 series 10 aircraft (DC-10-10) (N110AA), taxied from the gate at Chicago-O'Hare International Airport, Illinois. Flight 191, a regularly scheduled passenger flight, was en route to Los Angeles, California, with 258 passengers and 13 crewmembers on board. Maintenance personnel who monitored the flight's engine start, push-back, and start of taxi did not observe anything out of the ordinary.

The weather at the time of departure was clear, and the reported surface wind was 020° at 22 kns. Flight 191 was cleared to taxi to runway 32 right (32R) for takeoff. The company's Takeoff Data Card showed that the stabilizer trim setting was 5° aircraft noseup, the takeoff flap setting was 10°, and the takeoff gross weight was 379,000 lbs. The target low-pressure compressor (N<sub>1</sub>) rpm setting was 99.4 percent, critical engine failure speed (V<sub>1</sub>) was 139 knts indicated airspeed (KIAS), rotation speed (V<sub>R</sub>) was 145 KIAS, and takeoff safety speed (V<sub>2</sub>) was 153 KIAS.

Flight 191 was cleared to taxi into position on runway 32R and hold. At 1502:38, the flight was cleared for takeoff, and at 1502:46 the captain acknowledged, "American one ninety-one under way." Company personnel familiar with the flightcrew's voices identified the captain as the person making this call and the ensuing V<sub>1</sub> and V<sub>R</sub> speed callouts on the cockpit voice recorder (CVR).

The takeoff roll was normal until just before rotation at which time sections of the left, or No. 1, engine pylon structure came off the aircraft. Witnesses saw white smoke or vapor coming from the vicinity of the No. 1, engine pylon. During rotation the entire No. 1 engine and pylon separated from the aircraft, went over the top of the wing, and fell to the runway.

Flight 191 lifted off about 6,000 ft down runway 32R, climbed out in a wings-level attitude, and reached an altitude of about 300 ft above the ground (a.g.l.) with its wings still level. Shortly thereafter, the aircraft began to turn and roll to the left, the nose pitched down, and the aircraft began to descend. As it descended, it continued to roll left until the wings were past the vertical position.

Flight 191 crashed in an open field and trailer park about 4,600 ft northwest of the departure end of runway 32K. The aircraft was demolished during the impact, explosion, and ground fire. Two hundred and seventy-one persons on board Flight 191 were killed, two persons on the ground were killed, and two persons on the ground sustained second- and a third-degree burns.

The aircraft crashed about 1504, during daylight hours; the coordinates of the crash site were 42°00'35"N, 87°55'45"W.

<sup>1/</sup> All times herein are central daylight time, based on the 24-hour clock.

1.2 Injuries to Persons

<u>Injuries</u>	<u>Crew</u>	<u>Passengers</u>	<u>Others</u>
Fatal	13	258	2
Serious	0	0	2
Minor/None	0	0	0

1.3 Damage to Aircraft

The aircraft was destroyed.

1.4 Other Damage

An old aircraft hangar, several automobiles, and a mobile home were destroyed.

1.5 Personnel Information

All flight and cabin personnel were qualified. (See appendix B.)

1.6 Aircraft Information

Flight 191, a McDonnell-Douglas DC-10-10, N110AA, was owned and operated by American Airlines, Inc., and was powered by three General Electric CF6-80 engines (See appendix C.) According to the manufacturer, the left engine weighed 11,512 lbs, the pylon, 1,865 lbs, for a total engine-pylon assembly weight of 13,477 lbs. With the loss of the engine pylon structure, the aircraft's center of gravity (c.g.) moved aft 2 percent to about 22 percent mean aerodynamic chord (MAC). The resultant c.g. was within the forward (16.4 percent MAC) and aft (30.8 percent MAC) c.g. limits. The lateral c.g. shift was 11.9 inches to the right.

1.7 Meteorological Information

At the time of the accident, the weather at the airport was clear. The surface observations at O'Hare International were as follows:

1451, surface aviation: Clear, visibility--15 mi, weather--none, temperature--63°F, dewpoint--29°F, winds--020° at 22 kns, altimeter--30.00 inHg.

1511, local: Clear, visibility--15 mi, weather--none, temperature--63°F, dewpoint--29°F, winds--020° at 19 kns gusting to 28 kns, altimeter--30.00 inHg., remarks--aircraft mishap.

1.8 Aids to Navigation

Not applicable.



7

1.9 Communications

There were no known communications malfunctions.

1.10 Aerodrome Information

Chicago-O'Hare International Airport is located 16 mi northwest of downtown Chicago, Illinois, and is served by seven runways. Runway 32R is 10,003 ft long and 150 ft wide, and has a concrete surface. The runway elevation is 649 ft mean sea level (m.s.l.) at its southeast end and 652 ft m.s.l. at its northwest end.

1.11 Flight Recorders

The aircraft was equipped with a Fairchild Model A-100 CVR, serial No. 2935. The CVR was recovered and brought to the Safety Board's laboratory where a transcript of the recording was prepared. The recording was incomplete because of the loss of electrical power to the recorder during aircraft rotation. However, the aircraft's gross weight, stabilizer trim setting,  $V_1$ , and  $V_R$  callouts were recorded.

The aircraft was equipped with a Sundstrand digital flight data recorder (DFDR), serial no. 2298. The recorder had been damaged structurally, but there was no fire or heat damage. The recording tape was broken; upon removal from the recorder the tape was spliced together and a readout was made. Two 6-sec areas of data were damaged because of the breaks in the tapes; however, most of these data was recovered.

The DFDR recorded 50 sec of data during the takeoff roll and 31 sec of airborne data before the recording ended. (See appendix H.) The DFDR readout showed that the stabilizer trim setting for takeoff was  $8.5^\circ$  aircraft noseup. The DFDR's tolerance for this parameter is  $\pm 1^\circ$ . Because of unusual aircraft attitudes during the last few seconds of the flight, the recorded altitude and airspeed data were not correct. Therefore, the DFDR altitude and indicated airspeed values cited hereafter have been corrected for the position errors resulting from the aircraft's attitudes during the last few seconds of the descending flight.

Correlation of the DFDR and CVR recordings disclosed that the flightcrew had set the flaps and stabilizer trim at  $10^\circ$  and about  $5^\circ$  aircraft noseup, respectively, for takeoff. A rolling takeoff was made, takeoff thrust was stabilized at E0 KIAS, and left rudder and right aileron were used to compensate for the right crosswind. The  $V_1$  and  $V_R$  callouts were made about 2 sec after these speeds were recorded by the DFDR. The elevator began to deflect up at  $V_R$ . The aircraft began to rotate upward immediately and continued upward at a rate of  $1.5^\circ$  per sec. Flight 191 accelerated through  $V_2$  speed during rotation and before it lifted off the runway. The last stable takeoff thrust on the No. 1 engine was recorded 2 sec before liftoff. One second later, the word "damn" was recorded on the CVR, and then the CVR ceased operating.

One second before liftoff and simultaneous with the loss of the CVR and the No. 1 engine's parameters, the DFDR ceased recording the positions of the left inboard aileron, left inboard elevator, lower rudder, and Nos. 2 and 4 left wing leading edge slats. The DFDR continued to record all other parameters



including the position of the upper rudder, the outboard aileron, the outboard elevator, and the No. 4 leading edge slats on the right side of the aircraft. The electrical power for the CVK and the sensors for the lost DFDH functions were all derived from the aircraft's No. 1 a.c. generator bus.

Flight 191 became airborne about 6,000 ft from the start of the takeoff roll and remained airborne for 31 sec. It lifted off at  $V_2 + 6$  KIAS and at  $10^\circ$  pitch attitude. Two seconds after liftoff, the UFDR reading for the No. 1 engine's  $N_1$  was zero, the No. 2 engine's  $N_1$  speed was increasing through 101 percent, and the No. 3 engine's  $N_1$  was essentially at the takeoff setting.

The flight lifted off in a slight left wing-down attitude. Application of right wing-down aileron and right rudder restored the flight to a wings-level attitude and the heading was stabilized between  $325^\circ$  and  $327^\circ$ . The flight maintained a steady climb about 1,150 feet per minute (fpm) at a  $14^\circ$  noseup pitch attitude--the target pitch attitude displayed by the flight director for a two-engine climb. During the climb, the No. 2 engine  $N_1$  speed increased gradually from 101 percent to a final value of 107 percent; the No. 3 engine  $N_1$  speed did not change appreciably from the takeoff setting. During the initial part of the climb, the aircraft accelerated to a maximum speed of 172 KIAS; it reached this value about 9 sec after liftoff and about 140 ft a.g.l.

Flight 191 continued to climb about 1,100 fpm. The pitch attitude and heading were relatively stable. Right wing-down aileron and right rudder were used to control and maintain the heading and the roll altitude during the climb in the gusty right crosswind.

During the climb, the aircraft began to decelerate from 172 KIAS at an average rate of about 1 kn per second. At 20 sec after liftoff, at 325 ft a.g.l. and 159 KIAS, the flight began to roll to the left and passed through  $5^\circ$  left wing down. The left roll was accompanied by increasing right-wing-down aileron deflection. At this point, the previously stabilized right rudder deflected suddenly to zero, remained at zero for 1 sec, and then moved toward its previous deflection. The flight began to turn to the left, and the left roll increased even though increasing right rudder and right-wing-down aileron deflections were being applied. At 325 ft a.g.l. the flight had turned through the runway heading and was rolling to the left at  $4^\circ$  per second. The right rudder deflection increased during the turn. The previously stable pitch attitude began to decrease from  $14^\circ$  even though the elevator was being increased to the full aircraft noseup deflection. The maximum pitch rate of about  $12^\circ$  per second was reached just before the crash.

Flight 191 continued to roll and turn to the left despite increasing right rudder and right-wing-down aileron deflections. Three seconds before the end of the DFDK tape, the aircraft was in a  $90^\circ$  left bank and at a  $0^\circ$  pitch attitude. The DFUR recording ended with the aircraft in a  $112^\circ$  left roll and a  $21^\circ$  nosedown pitch attitude with full counter aileron and rudder controls and nearly full up elevator being applied.

DFDR longitudinal and vertical acceleration data were integrated to determine the headwind components at points where the aircraft attained certain speeds and where it lifted off; to establish an altitude profile; and to determine the location where the DFDK stopped. These data showed that the DFDK ceased operation 14,370 ft from the southeast end of runway 32R and 820 ft left of the runway's extended centerline. Examination of the crash site showed that the first point of impact was 14,450 ft beyond the southeast end of runway 32R and 1,100 ft left of its extended centerline. Based on these data and the corrected altitudes, the DFDK ceased operating at impact. The flight reached a maximum altitude of 350 ft a.g.l.

#### 1.12 Wreckage and Impact Information

Flight 191 struck the ground in a left wing-down and nosedown attitude. The left wingtip hit first, and the aircraft exploded, broke apart, and was scattered into an open field and a trailer park. The disintegration of the aircraft structure was so extensive that little useful data were obtained from postimpact examination of the wreckage with the exception of the No. 1 pylon, which was found off the right side of runway 32R. (See figure 1.)

Investigators located and documented identifiable aircraft components. Except for the No. 1 engine and pylon, portions of the engine cowling, and a part of the leading edge of the wing directly above the pylon, the aircraft wreckage came to rest in the open field and trailer park. (See appendix D.)

The first marks made by engine contact of the No. 1 engine and pylon with the runway began about 19 ft to the right of the centerline lights and about 6,953 ft beyond the southeast end of runway 32R. Other parts of engine and pylon structure were located in this area; however, no spoiler actuators or hydraulic lines were found.

The pylon is attached to the wing using spherical ball joints in three different structural elements. Two of the spherical joints are aligned vertically in a forward bulkhead which is attached to structure in the wing forward of the front spar. Another spherical joint behind the forward bulkhead transmits thrust loads from pylon structure into a thrust link which in turn is connected through another spherical joint to structure on the lower surface of the wing. The third attachment point is a spherical joint in the pylon aft bulkhead which attaches to a clevis mounted on the underside of the wing. The pylon forward bulkhead and portions of the flange from the pylon aft bulkhead either remained with the separated No. 1 pylon or were scattered along the runway. (See figures 2 and 3.) The No. 1 pylon's aft clevis attach assembly and portions of the pylon aft bulkhead, wing thrust angle assembly and thrust link, and pylon forward bulkhead attach assembly remained with the wing.

The pylon forward bulkhead was bent forward about 30° and most of the bolts which held the bulkhead upper plates were missing. The upper 12 inches of the forward plate were bent forward an additional 10° to 15°. The aft plate was broken below the thrust fitting connection, and a large piece of the upper left corner was missing.



Figure 1. Accident site.

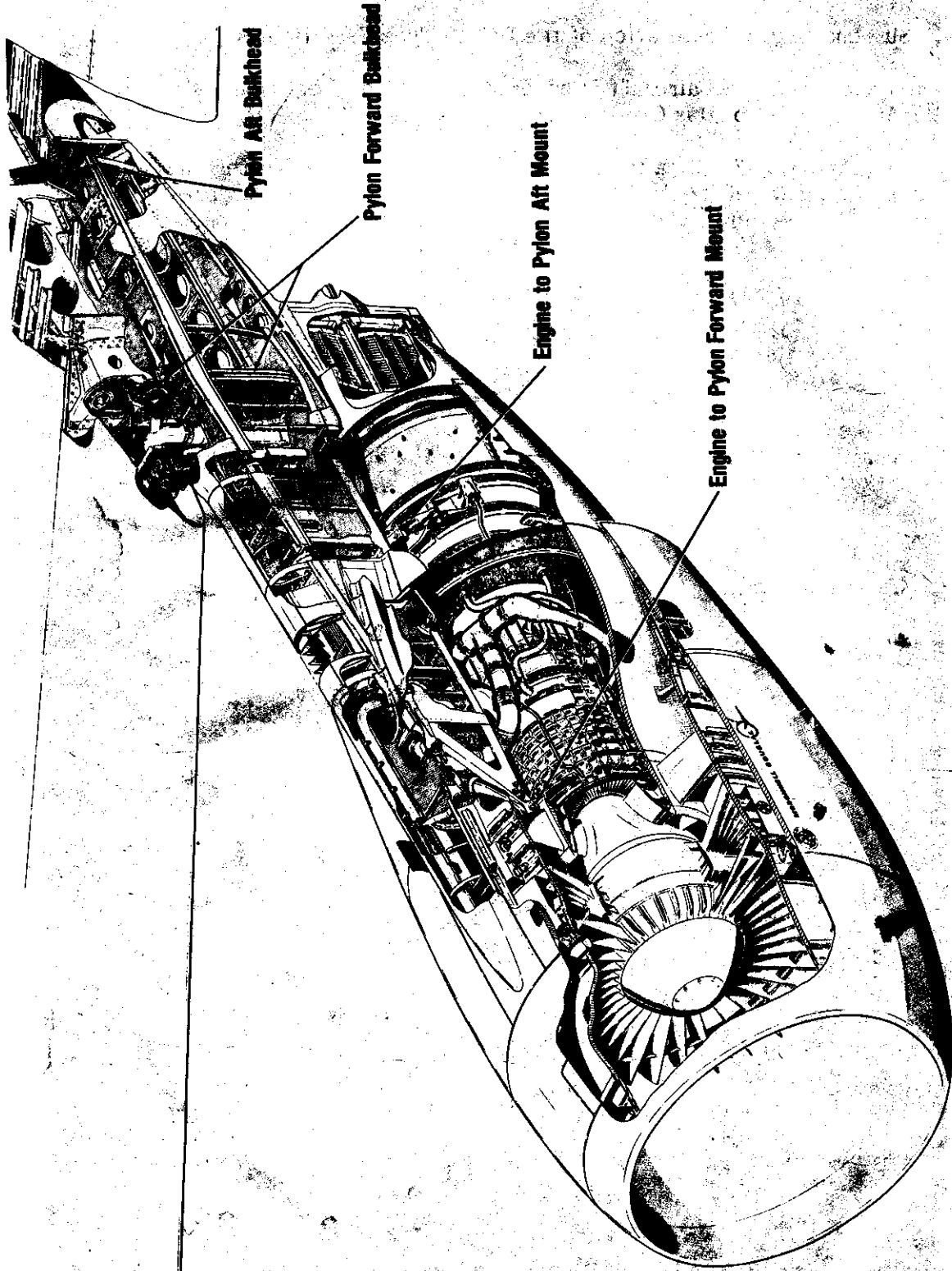

Figure Engine and pylon assembly.

# PYLON-TO-WING ATTACHMENT PROVISIONS

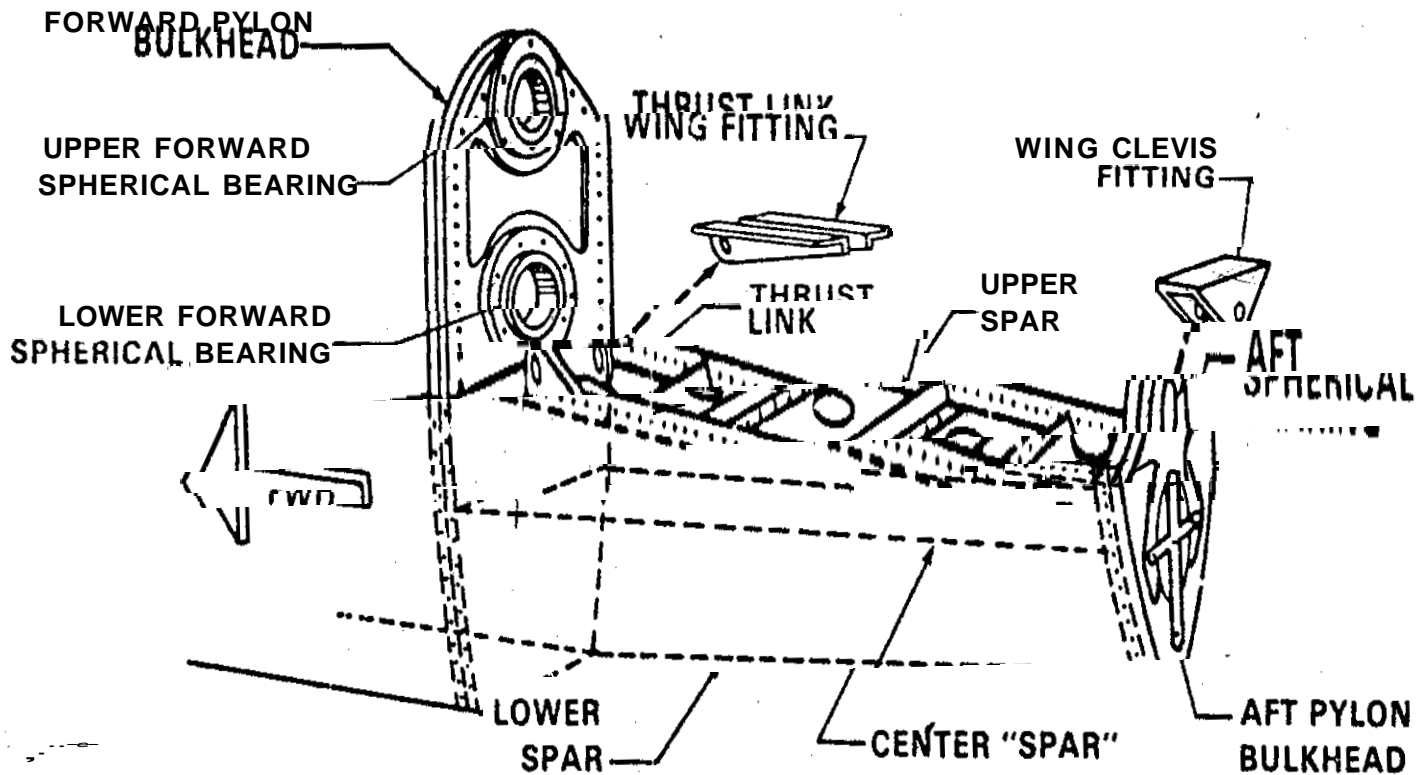

Figure 3. Pylon assembly.

The wing's forward support fitting, which attached the pylon forward bulkhead to the wing at the upper and lower plugs and spherical bearings, was found at the **main** wreckage site. The upper and lower plugs and their attaching hardware were intact, and the upper and lower spherical bearings were attached to the fitting.

The pylon thrust fitting remained attached to the forward portion of the pylon's aft upper spar web. The pylon thrust link, which attached the pylon thrust fitting to the wing thrust angles, was found at the main wreckage site attached to a portion of the wing thrust angles. Its forward spherical bearing was cocked to the extreme left, and a segment of the bearing which had broken away was found on the runway.

The thrust bushing bolt had broken in two parts, both of which were found in the **grass** adjacent to the runway. The bolt nut was attached to one of the broken pieces, and the faces of the nut were gouged severely. Except for one lubrication **retainer** washer, which was not found, the **remaining** portions of the thrust bushing bolt assembly were found along the runway. One shim spacer from the assembly was crushed severely while the other was **relatively undamaged**.

The upper two-thirds of the pylon aft bulkhead separated from the flanges around its periphery and was found in the wreckage. The top two pieces of its attach lugs had separated from the bulkhead, and the left side of the bulkhead was gouged heavily near the lower edge of the wing clevis lug, which **attached** the aft bulkhead to the wing. The wing clevis was attached to the wing. The aft bulkhead's spherical bearing was **attached** to the clevis, and the separated pieces of the aft bulkhead's attach lugs were found on top of the spherical bearing.

The Nos. 2 and 3 engines were located in the main wreckage. The damage to the engines indicated that they were operating at high rpm at impact. All three engines were taken to the American Airline's Maintenance Facility at Tulsa, Oklahoma, where they were torn down and examined. There was no evidence of any preimpact malfunctions.

The examinations of the main and nose landing gears and actuators indicated that the gear was down and locked at impact. The left and right stabilizer jackscrews were recovered and the distance between the upper surfaces of the jackscrews' drive nuts and the lower surfaces of the actuators' upper stops was measured. These measurements indicated that the stabilizer was positioned at **5.71° aircraft noseup**.

Examination of the hydraulic system components did not reveal any evidence of internal operating distress. The control valve of the 2-1 nonreversible motor pump was in the open position, indicating that the No. 2 hydraulic system was driving the No. 1 hydraulic system's pump.

All eight flap actuators were recovered, and investigators attempted to verify the position of the trailing edge flaps by measuring the extension of the flap actuator pistons. The piston extensions were compared to those of another aircraft with flaps extended to 10°. Based on this comparison, some degree of

flap extension was probable, but the actual position could not be established. However, the DFDR data showed that the flaps were set at 10°.

A 3-ft section of the left wing's leading edge, just forward of the point where the forward part of the pylon joined the wing, was torn away when the engine pylon assembly separated from the aircraft. The No. 1 and No. 3 hydraulic system's extension and retraction lines and the followup cables for the left wing's outboard slat drive actuators were severed. Thirty-five of the 36 leading edge slat tracks were examined. The examination disclosed that at impact the left wing's outboard slats were retracted, while the left wing's inboard **slats** and the right wing's inboard and outboard **slats** were extended to the takeoff position.

The examination of the cockpit instruments did not disclose any usable information.

### 1.13 Medical and Pathological Information

A review of the autopsies and toxicological examinations of the **flightcrew** disclosed no evidence of preexisting physiological problems which could have affected their performance.

### 1.14 Fire

The aircraft was subjected to severe ground fire.

### 1.15 Survival Aspects

This accident was not survivable because impact forces exceeded human tolerances.

### 1.16 Tests and Research

#### 1.16.1 Study of Photographs

Five photographs taken of Flight 191's departure by two cameras--one in the terminal and one onboard a DC-10 on final approach to runway 9R--were sent to Lockheed's Palo Alto Research Laboratories for a Photo-Image Enhancement Study to determine the position of the flight controls. The process produced black and white images containing expanded variations of gray shading which, in the absence of the enhancement process, would be too subtle for the eye to distinguish. Based on the study of these photo-images, the following observations were made: (1) The tail assembly was not damaged; (2) the nose gear was down during the initial climbout and before the onset of roll; (3) spoilers Nos. 1, 3, and 5 were extended on the right wing; and (4) the trailing edge of the right wing inboard aileron was up. Although the position of the **slats** was difficult to determine, the left wing inboard **slats** appeared to be extended, and the position of all other control surfaces appeared to be the same as recorded by the DFDR. The pitch and roll attitudes of the aircraft were extrapolated from the photographs, and extrapolations agreed closely with those recorded by the DFDR.

1.16.2 Metallurgical Examinations and Postaccident Inspections of the DC-10 Fleet

N110AA's pylon aft bulkhead was examined at the Safety Board's metallurgical laboratory. The examination disclosed a fracture of the upper forward flange. (See figure 4.) The larger part of this fracture was just forward of the radius between the flange and forward bulkhead plane and was about 10 inches long in the inboard-outboard direction. (See figure 5.) The fracture characteristics were typical of an overload separation. Chevron and tear marks on the fracture indicated that the rupture progressed downward at the center of the flange, then in inboard and outboard directions on the flange. The bottom portion of the fracture exhibited smearing consistent with the compression portion of a bending fracture. The smear was more prevalent—about 6 inches long—in the thinner center portion of the upper flange structure, but became less prevalent at the outer ends of the fracture. The 10-inch-long fracture resulted from overstress. The overstress was initiated by the application of a downward bending moment at the center section of the flange just forward of the fracture plane. The surface of the fracture appeared to be relatively free of oxidation and dirt.

Fatigue cracking was evident at both ends of the fracture. At the inboard end, the fatigue progressed inboard and aft; then, it progressed downward and inboard to the upper inboard fastener that attached the forward section of the bulkhead to the aft section. The fatigue progressed past the fastener a short distance before exhibiting rapid overstress characteristics in the downward direction as it proceeded along the inboard side of the side flange radius of the forward flange section. At the outboard end of the fracture, the fatigue propagated forward and slightly outboard toward the most forward outboard hole in the upper flange. The total length of the overstress fracture and fatigue cracks was about 13 inches. The remainder of the fractures on the bulkhead and within the pylon structure resulted from overload.

The examination also disclosed that three shims were installed on the upper surface of the forward upper flange. Two shims (Part No. AUB-7034-25) were installed, one on the inboard top shoulder of the upper flange and one on the outboard top shoulder. These shims are about 2 inches long, 1 inch wide, and .063 inch thick. A 10-inch-long, .050-inch-thick shim was installed during production to fill a gap between the upper flange and upper spar web. (See figure 6.) The manufacturer's drawings specify that the AUB-7034-25 shim may be required along the side of the bulkhead; however, they do not indicate that shims may be required on the upper surface of the flange. The fatigue propagation on the inboard and outboard ends of the overstress fracture began in the area underneath the .063-inch-thick shims.

The aft fracture surface of the upper flange contained a crescent-shaped deformation which matched the shape of the lower end of the wing clevis. This deformation was in line with the vertical centerline of the aft bulkhead attachment hole as indicated by arrow "d" in figure 7. A deformation was noted in the lower surface of the aft wing support fitting's forward clevis lug in the area indicated by the brackets in figure 9. A small shallow gouge was apparent in the area of the arrow in figure 10. This gouge was in a position which would conform to a fastener location on the top flange assembly of the aft bulkhead.





Figure 4. Overall view of the wing pylon aft bulkhead installation portions. Pieces are numbered for identification purposes and placed in relative locations as if intact.

- Item 1. Aft bulkhead center section piece view looking aft.
- Items 2 & 3. Upper lug ears.
- Items 4 & 5. Two pieces of the forward portion of the upper flange. Those pieces mated together along the fracture indicated by arrows "m."
- Item 6. Side flanges and lower portion of the aft bulkhead.
- Item 7. Piece of the flange at the upper outboard corner.
- Item 8. Portion of the outboard side flange.
- Item 9. Piece of the intermediate flange.

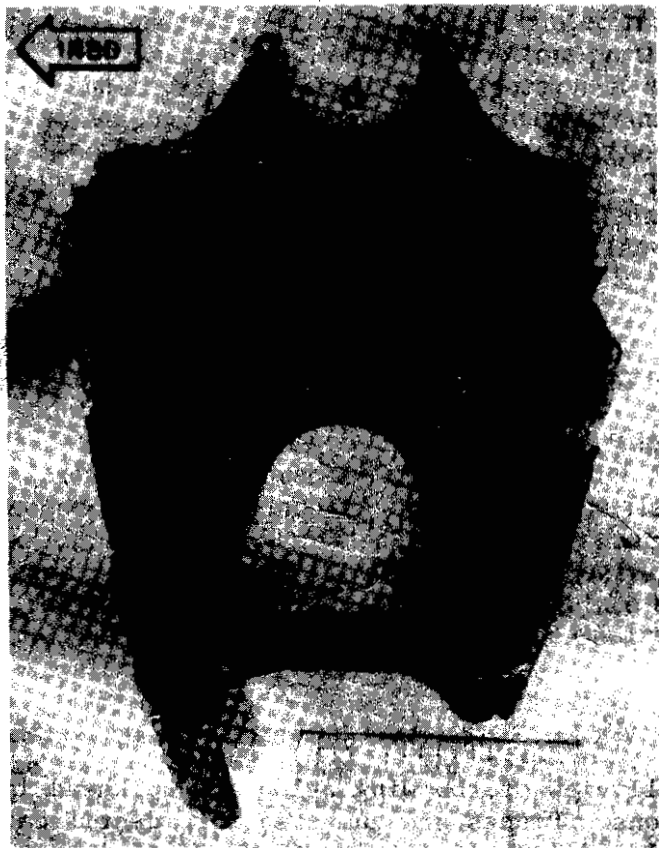

Figure 5. View of the aft bulkhead piece indicated as Item 1 in Figure 4.

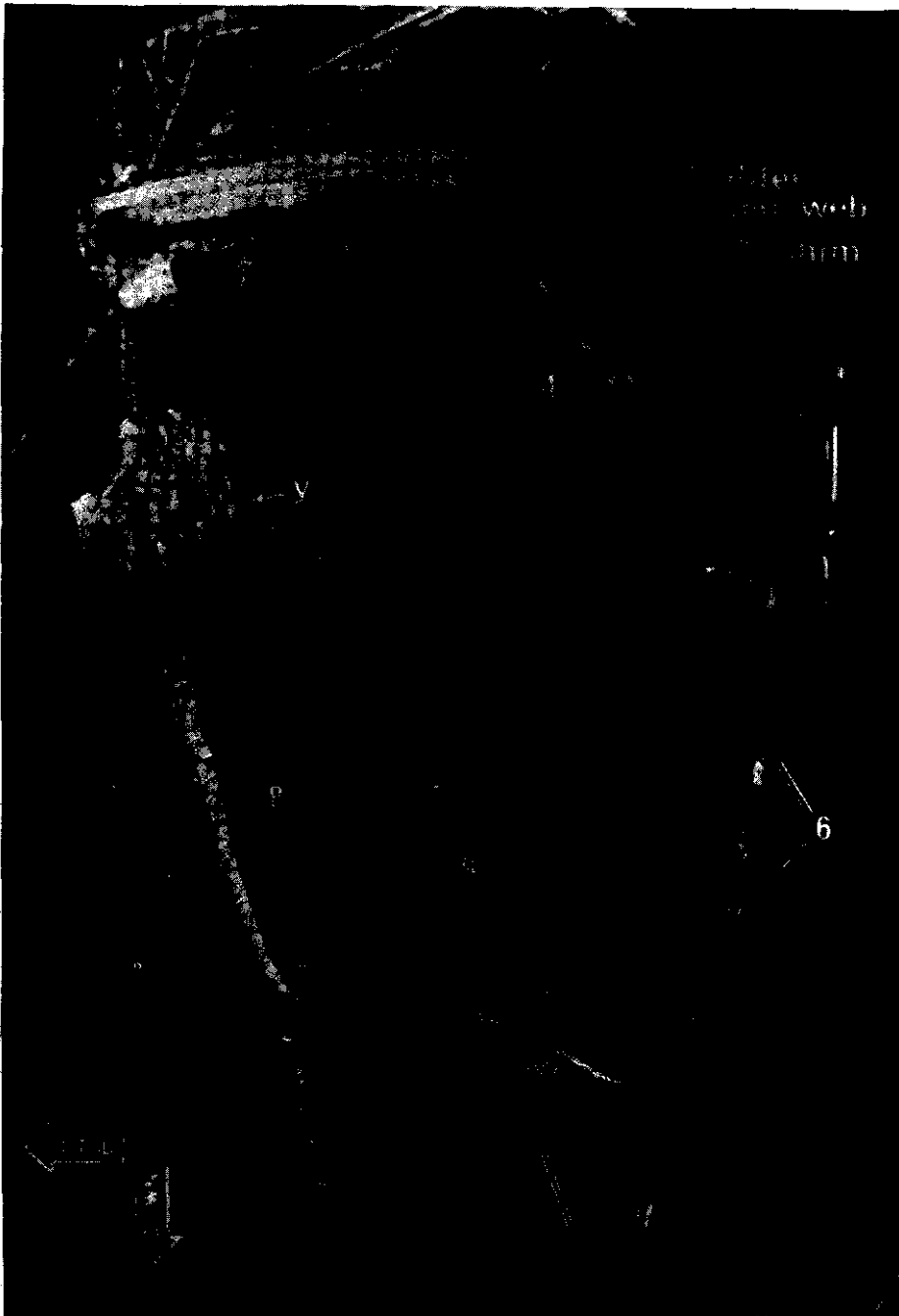

Figure 6. View looking forward and slightly down on the No. 1 pylon before disassembly of the flange pieces indicated as items 4 through 9 in Figure 4. Arrow "x" shows the shim on the outboard side between the angle and the top surface of the upper flange piece No. 7 held in place by the fastener arrowed "y". Arrow "s" shows the location for the shim on the inboard side between the angle and upper surface of the upper bulkhead flange.

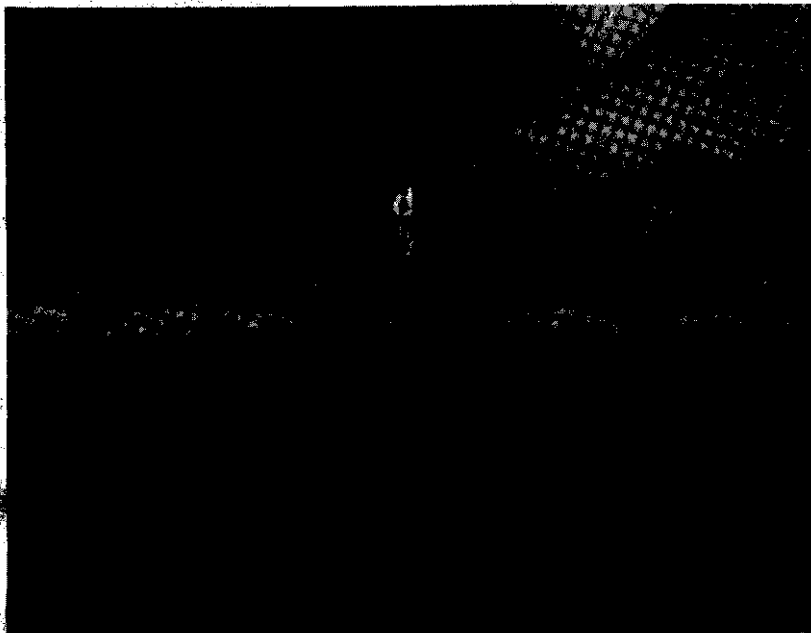

Figure 7. Closer view of fracture on upper flange in the area of deformation (arrow "d", see Figure 5).



Figure 8. Detail of deformation denoted by arrows "d" in Figure 5 and 7.

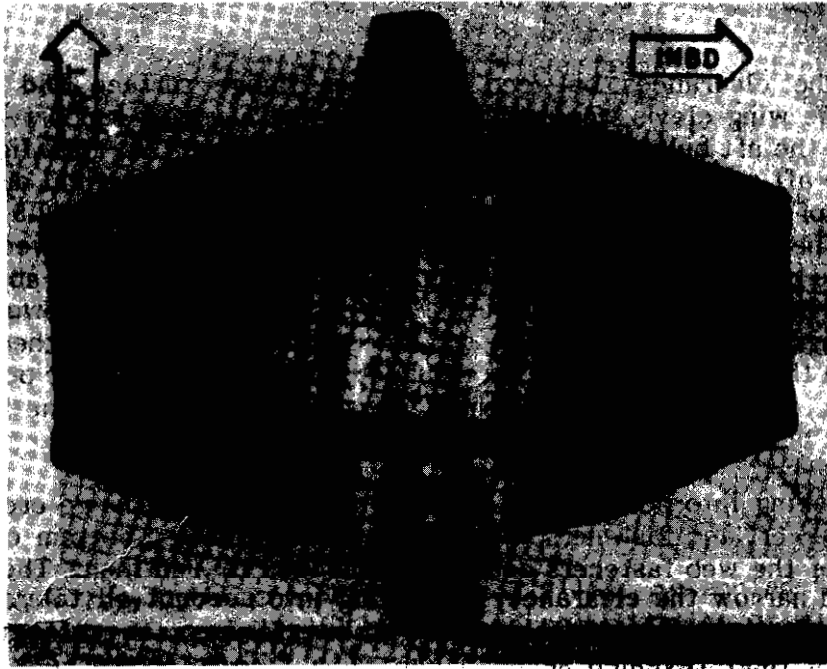

Figure 9. Overall view looking up on the wing mounted aft support fitting with spherical bearing attached.

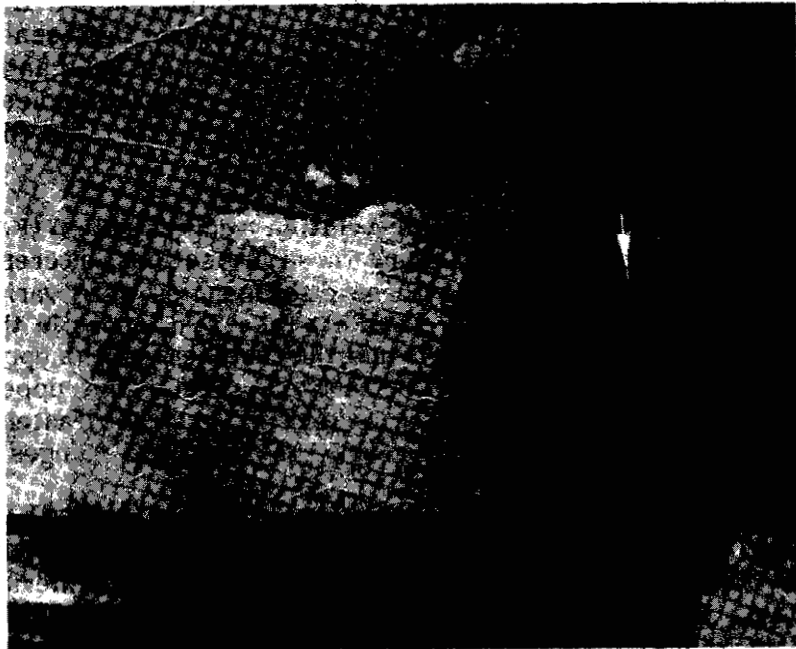

Figure 10. Close up view of damage in the area between the brackets of Figure 9.

The gouge appeared to be produced by a fastener head, hitting the clevis with a sliding movement. The upper flange aft fracture surface and radius appeared to have been deformed by the wing clevis' striking these surfaces in the downward direction.

The clearances between the upper flange surface and the bottom surface of the wing clevis were examined using the aft wing support fitting from N110AA and the aft bulkheads of another DC-10-10 (N119AA). (See figures 11 and 12.) With the aft spherical bearing and bushing in place, the vertical distance from the bottom of the clevis to the surface of the flange is about 0.5 inch. (See figure 11.) When the bushing was removed and the aft bulkhead moved up against the far inside portion of the wing fitting, the flange was displaced about 0.6 inch above its previous position. (See figure 12.) In this position, the lower portion of the clevis was about 0.1 inch below the fracture on N110AA's bulkhead. The 0.1 inch between the upper flange fracture's upper surface and the lower portion of the wing fitting clevis was the same as the vertical depth of the deformation found on N110AA's aft bulkhead.

Taking into account the stackup on the forward flange created by the spar web, doubler, and fasteners, the clearance between the bottom of the clevis and the top of the web fasteners could be about .005 to .045 inch. The addition of a shim would narrow the clearance, and taking into account all tolerances in the spherical bearing assembly, there could be an interference. A postaccident survey of the DC-10 fleet revealed seven pylons with such interference. McDonnell-Douglas had not established a standard minimum clearance between the bottom of the clevis and the top of the fastener.

Despite numerous searches of the runway and adjacent areas after the accident, investigators were not able to find one of the forward thrust bushing attachment's retainer washers. However, measurements between the mating portions on the fracture and the undersides of the thrust bolt head and nut as well as the physical evidence produced by the separation of the parts indicated that the missing washer was in place when the pylon separated and that the thrust bushing assembly had been installed properly.

After the accident, the Federal Aviation Administration (FAA) required a fleetwide inspection of the DC-10. During these inspections, discrepancies were found in the pylon assemblies. Among these discrepancies were variances in the clearances on the spherical bearing's fore and aft faces; variances in the clearance between the bottom of the aft wing clevis and the fasteners on the upper spar web; interferences between the bottom of the aft clevis and the upper spar web fasteners; pylons with either loose, failed, or missing spar web fasteners; and aft pylon bulkheads with upper flange fractures. The fractured flanges were found only on the DC-10-10 series aircraft.

During postaccident inspections, six DC-10's were found to have fractured upper flanges on the pylon aft bulkheads. Four American Airlines DC-10's--N106AA, N107AA, N118AA, N113AA-- and two Continental Airlines DC-10's--N68050, N68047.

The failure modes on the Continental Airlines' aircraft that were examined by metallurgists were similar to those found on the American Airlines' DC-10's. Of the two Continental fractures discovered during the postaccident

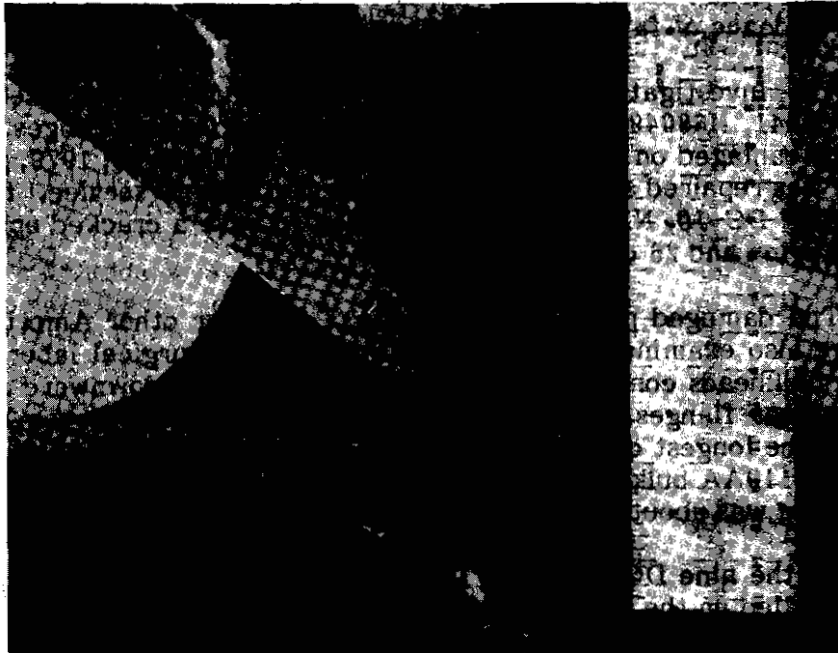

Figure 11. Wing pylon aft bulkhead from N119AA assembled to wing mounted aft support fitting of N110AA showing normal position of wing fitting clevis,, with respect to the upper forward flange of the aft bulkhead.  
Note: The wing fitting on this figure is canted relative to the bulkhead to simulate the dihedral of the left wing relative to the bulkhead.

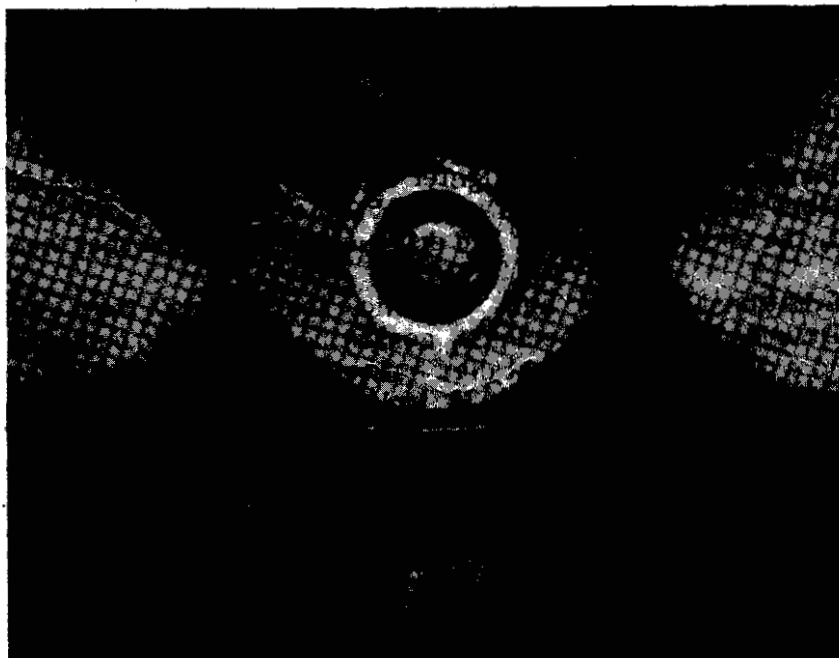

Figure 12. Same as Figure 11 except the attachment bushing was removed and the aft bulkhead was moved up against the far inside portion of the wing fitting. Note the location of the bottom portion of the wing fitting clevis with respect to the fracture on the bulkhead.

inspections, one crack was 6 inches long, and the other 3 inches long; neither crack showed any evidence of fatigue propagation.

The investigation also disclosed that two other Continental Airlines DC-10's--N68041, N68049--had had fractures on their tipper flanges. These two aircraft were damaged on December 19, 1978, and February 22, 1979, respectively. The damage was repaired and both aircraft were returned to service. In addition, a United Airlines' DC-10, N1827U, was discovered to have a cracked upper spar web on its No. 3 pylon and 26 damaged fasteners.

The damaged pylon aft bulkheads of the four other American Airlines' DC-10's were also examined at the Safety Board's metallurgical laboratory. Each of these aft bulkheads contained visible cracks and obvious downward deformations along their upper flanges. The shortest crack appeared to be on the N107AA bulkhead and the longest crack--about 6 inches--was on the N119AA bulkhead. The crack on the N119AA bulkhead was the only one in which fatigue had propagated; the fatigue area was about .03 inch long at each end of the overstress fracture.

Of the nine DC-10's with fractured flanges, only the accident aircraft had shims installed on the upper surface of the flange.

#### 1.16.3 Stress Testing of the Pylon Aft Hull

As a result of the discovery of the damaged upper flange on the accident aircraft, laboratory tests were conducted in an attempt to reproduce the 10-inch overload crack. The testing involved both static and dynamic loading with and without the .050-inch-thick shim installed on the flange. Static load tests conducted by American Airlines<sup>2/</sup> involved the use of a Tinnius Olsen universal test machine and a shimmed (.050-inch) spar web. The results showed that the flange cracked under a 6,400-lb load and when deflected .122 inch. The initial crack was 1.1 inch long. The crack progressed through the flange when the flange was deflected 0.2 inch after loading of 7,850 lbs; its length was 2.8 inches. Once the flange was penetrated, it required lighter loads to produce greater deflections. A crack 7.4 inches long was produced with a 5,175-lb load at a 0.6-inch deflection. At this point, the ends of the crack had disappeared under the spar web.

Additional static and dynamic load tests were conducted at McDonnell-Douglas. A test specimen, consisting of the aft bulkhead, connecting spar web, and a .050-inch shim installed between the bulkhead flange and the spar web, was used in one static test. A jackscrew was used to apply load to the specimen. Cracking began when the flange was deflected 0.1 inch with an applied load of about 6,900 lbs. At 11,500 lbs, the flange was deflected 0.2 inch, and the crack propagated to about 2 inches. Increasing the deflection to 0.6 inch lengthened the crack to 7.5 inches; however, the required load was only 8,600 lbs.

The evidence indicated that the maximum interference that would result from the insertion of the .050-inch-thick shim was .024 inch. The static tests conducted by American Airlines and McDonnell-Douglas showed that a crack would begin at a deflection of about 0.1 inch; thus, in the worst case, an additional deflection would be required to crack the flange.

<sup>2/</sup> A machine used to apply precise and measurable amounts of stress to materials undergoing testing.



During dynamic testing, seven specimens were subjected to impact loads of varying energy levels and numbers of strikes. Specimens struck at high energy levels (6,000 inch-pounds) failed in unrelated modes. Specimens struck at low energy levels (1,500 to 2,500 inch-pounds) required seven to eight strikes to create an 8- to 10-inch-long crack. The total absorbed energy required to produce a 10-inch crack in an unshimmed specimen was 16,000 inch-pounds. The absorbed energy required to create a 10-inch crack in a shimmed specimen (.050-inch thick) was about 18,000 inch-pounds. In one test, a 10-inch crack was produced on an unshimmed specimen after two blows; the total absorbed energy was 5,200 inch-pounds.

In another test, conducted by American Airlines, an aft bulkhead, in which a 6-inch crack had been produced in the flange by forcing a simulated wing clevis vertically down on pylon web bolts, was subsequently subjected to a thrust load. With a thrust load of 11,625 pounds, the 6-inch crack extended to 10 inches, at which point the thrust load was relieved.

The major elements of the pylon structure were also examined to determine primary and fail-safe <sup>3/</sup> load paths. Normally the vertical and side forces, as well as torque or rolling moments in the plane of the bulkhead, are transmitted from the pylon structure through the spherical joints in the forward and aft bulkheads and into the wing structure. All of the thrust load from the pylon is intended to be transmitted through the thrust link.

The capability of the forward and aft bulkheads to serve as alternate fail-safe load paths in the event of a thrust link failure was assessed during the postaccident investigations. Therefore, in addition to the tests of the upper flange, a full-scale wing pylon test was conducted to evaluate load distributions and flexibility of the pylon-mounted bulkheads both with and without a thrust link installed.

The design gap between the forward and aft faces of the aft spherical bearing and the respective faces of the clevis is .080 inch. With this clearance, minimal thrust loads of about 600 lbs are experienced at the aft bulkhead. However, during the postaccident investigation, this gap was measured throughout the DC-10 fleet, and the smallest gap found was .047 inch. With that size gap and the engine at maximum thrust, thrust loads of about 6,650 lbs are experienced at the aft bulkhead; this load is still within the bulkhead's strength capability.

The failed thrust link tests showed that the thrust load was distributed between the aft and forward bulkheads—75 percent of the load (30,000 lbs) at the aft bulkhead and 25 percent at the forward bulkhead. The imposition of 75 percent of the thrust load on the aft bulkhead will shorten its service life. According to the evidence for the worst case, which is a DC-10-40 with the largest available engines, the estimated life of the aft bulkhead would be greater than 3,000 flight-

---

<sup>3/</sup> Fail-safe means that in the event of a failure of a major element, the loads carried by that element are redistributed to another load path which can accommodate the load.

hours. The bulkhead of the DC-10 series 10, 30, and 40 aircraft are essentially identical. Further analysis based on the DC-10-10 thrust showed that an undamaged aft bulkhead would support the entire thrust load.

During the postaccident investigation, McDonnell-Douglas conducted flight tests to measure the wing pylon's relative deflection at the aft pylon mount and the stress created at selected nearby structural members throughout the normal flight regime. The flight regime investigated included, in part, taxi; takeoff including normal and rapid rotations; 2-G turns; moderate turbulence encounters; 2-G pullups, 0.2-G pushovers, landings, and rollouts; and the effects of maximum reverse thrust. The highest stresses measured on the aft bulkhead were less than 10 percent of the static strength of the material in the bulkhead.

Other tests were conducted at McDonnell-Douglas to determine the stress distribution and residual strength of the aft bulkhead under various load conditions with cracks in the forward flange. The aft bulkhead was mounted in a cantilevered structure that simulated the aft 3 ft of the pylon. Loads were applied to the bulkhead through the lug of the aft pylon at the wing attachment joint. The damage to the bulkhead was imposed by saw cuts, the ends of which were further cracked by the application of cyclic loads. Photo-stress and strain gage data were taken with the flange cracked 6 inches, 10.5 inches, and 13 inches; the latter condition was intended to replicate the crack and fatigue damage evident on the accident aircraft. It was determined that even a 6-inch crack would extend by fatigue progression with the application of cyclic loads representative of those encountered in service. The vertical and side loads representing those for a takeoff rotation with gusty crosswinds were applied to the bulkhead with the 13-inch crack without producing failure. A thrust component load was then added and increased to 9,000 lbs. at which time the bulkhead failed. The ends of the 13-inch crack, however, progressed to fastener holes, whereas the crack in the accident bulkhead did not. A theoretical analysis by a McDonnell-Douglas stress engineer showed that vertical and side loads alone could fail the bulkhead completely with a 13-inch preexistent crack in the forward flange.

During the reassessment of the fail-safe analysis of the aft bulkhead, the effect of a 6-inch fracture on the bulkhead's forward upper flange was further analyzed and tested. The crack location was similar to the locations of those found during postaccident inspections. The analysis and tests showed that the damaged structure could carry the fail-safe design loads for the worst case—the aircraft with the largest engine.

During ground operation of the aircraft—taxiing, landing, and takeoff rolls—the aft bulkhead is subjected to compression loads and the aft end of the pylon is forced upward. During rotation, the loading changes and the aft bulkhead is subjected to tension-type loads. Those loads were found to be significantly lower than the fail-safe design loads.

#### 1.16.4 Wind Tunnel and Simulator Tests

The wind tunnel at the National Aeronautics and Space Administration's Langley Research Center was used to determine the aerodynamic characteristics

of a DC-10 wing with the left engine and pylon missing, left wing leading edge damaged, and the left wing's outboard leading edge slats retracted. In this configuration, the aircraft's stall speed, minimum control speeds with the critical engine inoperative ( $V_{MC}$ ), and controllability were calculated. The effects that the loss of the No. 1 hydraulic system and the possible loss of the No. 3 hydraulic system would have on the aircraft's control authority were also investigated and calculated.

The DFDR data, aerodynamic data derived from wind tunnel tests, and the atmospheric conditions on the day of the accident were integrated into the Douglas Motion Base Simulator. The following conditions were simulated: (1) the separation of the No. 1 engine and pylon and the aerodynamic effects of the separation and resultant damage, such as changes in the aircraft's gross weight and lateral and longitudinal c.g.; (2) the uncommanded retraction of the left wing's outboard leading edge slats; (3) the loss of the No. 1 and No. 3 hydraulic systems; (4) the loss of power from the No. 1 a.c. electrical bus and resultant loss of the captain's flight instruments; and (4) both the loss and retention of the stall warning system and its stickshaker function. ■ 4

The wind tunnel data for the damaged aircraft were correlated with the DFDR data so that the simulator data reflected those derived from Flight 191's DFDR. With the slats extended, the ad-engine-operating stall speed was 124 KIAS; the asymmetric slat-retracted stall speed for the left wing was 159 KIAS; and the estimated wings-level  $V_{MC}$  for the damaged aircraft was 128 KIAS. With a 4° left bank-- a bank into the missing engine -- 159 KIAS was the minimum speed at which directional control could be maintained with the engines operating at takeoff thrust.

Each of the thirteen pilots who participated in the simulation was thoroughly briefed on the flight profile of Flight 191. In the simulator the No. 1 engine and pylon assembly was programmed to separate at 10° of rotation on all takeoffs with simultaneous loss of the No. 1 hydraulic system. On some test runs the No. 3 hydraulic system was also programmed to fail. Generally, slats began to retract about 1 sec after the engine and pylon separated and were fully closed in about 2 sec. Some test runs were conducted with the slat retraction beginning 10 to 20 sec after the engine and pylon separated. Speed control guidance from the flight director was available for all runs, and the stickshaker, programmed for the slat-retracted-air speed schedule, was operational on some runs.

During the tests, about 70 takeoffs and 2 simulated landings were conducted. In all cases where the pilots duplicated the control inputs and pitch attitudes shown on the Flight 191's DFDR, control of the aircraft was lost and Flight 191's flight profile was duplicated. Those pilots who attempted to track the flight director's pitch command bars also duplicated Flight 191's DFUR profile. ✱

According to American Airline's procedures, the standard rate of rotation is between 3° to 4° per second, whereas Flight 191 rotated at only about 1.5° per second. In those simulations in which the standard rate was used, the aircraft lifted off at a lower airspeed, and the airspeed did not increase to the levels recorded by Flight 191's DFDR. The left roll began at 159 KIAS; however, because of the lesser amount of excess airspeed, the roll started below 100 ft a.g.l. In those cases where slat retraction was delayed, the left roll started at a higher altitude but its characteristics remained the same. In all cases, however, the roll began at 159 KIAS.

In many cases, ~~the pilots~~, upon recognizing the start of the roll at a constant pitch attitude, lowered the nose, increased airspeed, recovered, and continued flight. ~~The roll angles were less than 30°, and about 80 percent right rudder and 70 percent right-wing-down aileron) were required for recovery.~~ In those cases where the pilot attempted to regain the 14° pitch attitude commanded by the flight director command bars, the aircraft reentered the left roll.

On those test runs with an operative stickshaker programmed to begin at the slat-retracted-airspeed schedule, the stickshaker activated 7 sec after liftoff and the pilot flew the aircraft at the stickshaker boundary speed of 167 to 168 KIAS ( $V_2 + 15$ ). Also, when  $V_2 + 10$  was obtained and the pilot disregarded the pitch command bars, a stable climb was readily achieved. Attempts to duplicate the 1-sec interval of zero rudder displacement did not have any noticeable effect on the flight profile.

Based on the probable electrical configuration existing after the takeoff of Flight 191, pilots and test pilots who testified at the Safety Board's public hearing believed that the stall warning system and the slat disagreement warning light were inoperative. They stated that the flightcrew cannot see the No. 1 engine and left wing from the cockpit and, therefore, the first warning the flightcrew would have received of the stall was the beginning of the roll. Under these circumstances, none of these pilots believed that it was reasonable to expect the flightcrew of Flight 191 to react in the same manner as did the simulator pilots, who were aware of Flight 191's profile and were able to recover from the stall.

The FAA conducted a second series of tests to determine the takeoff and landing characteristics of the DC-10 with an asymmetrical leading edge slat configuration. The slat configuration which existed on Flight 191 before impact was duplicated during about 84 simulated takeoffs and 28 simulated landings. Takeoffs were performed at both normal and slow rotation rates, at normal  $V_R$  speeds, at  $V_R - 5$  kn, and with thrust reduced to simulate a limiting weight condition during a second-segment climb.

The "slat disagree" light, takeoff warning system, and stall warning system were programmed to operate properly for both the normal and asymmetric outboard slat configuration.

Landings were performed at the maximum landing weight, 50° of flap, and a normal approach speed. The simulator was programmed so that a left outboard slat failure would cause the slat to fully retract at altitudes as low as 30 ft a.g.l. The FAA concluded that "The speed margins during the final portion of the landing approach are also very small; however, the landing situation is considered less critical since powered slat retraction from the landing configuration requires 18 seconds and an additional thrust is readily available to adjust the flight path." 4/

4/ Report to the Administrator on the Investigation of the Compliance of the DC-10 Series Aircraft with Type Certification Requirements under Asymmetric Slat Condition, July 9, 1979.

During these tests, none of the pilots experienced problems with aircraft controllability. In many of the test runs, the stickshaker activated at or just after liftoff, and the pilots altered the aircraft's attitude and airspeed in response to the warning. A loss of thrust from an engine during the takeoff roll was not simulated during any of the tests. Based on a study performed by the J. H. Wiggins Company 5/, the best estimates of the probabilities of an uncommanded slat retraction during takeoff ranged from one chance in one hundred million ( $1 \times 10^{-8}$ ) to two chances in a billion ( $2 \times 10^{-9}$ ) per flight.

1.17 Other Information

1.17.1 Air Carrier Maintenance Procedures

On May 31, 1975, and February 1, 1978, the McDonnell-Douglas issued DC-10 Service Bulletins 54-48 and 54-59, respectively. Both bulletins were issued to correct service-related unsatisfactory conditions. Service Bulletin 54-59 called for the replacement of the pylon forward bulkhead's upper and lower spherical bearings and contained procedures for accomplishing the maintenance. Compliance was recommended at the "operator's convenience."

Service Bulletin 54-48 called for the replacement of the pylon aft bulkhead's spherical bearing, and compliance with the modification was "optional, based on operator's experience." The procedures for accomplishing the modification contained the following note: "It is recommended that this procedure be accomplished during engine removal." The Service Bulletin later reiterated the recommendation and then stated, "The following instructions assume that engines 1 and 3 are removed." However, the vice president for maintenance and engineering, American Airlines, testified at the Safety Board's public hearing that the manufacturer's consideration for maintenance timing is not necessarily consistent with air carrier operations. For example, American Airlines' maintenance cannot forecast "with any great accuracy" when or where an engine would have to be changed. Since "it has to be scheduled," it would have been impractical to try to carry out the procedures of Service Bulletin 54-48 in that manner, and the aircraft would have to be scheduled to undergo the modification.

Service Bulletin 54-48 directed that the pylons were to be removed in accordance with the procedures contained in Chapter 54-00-00 of the DC-10 Maintenance Manual. Chapter 54-00-00 called for, first, removal of the engine and then removal of the pylon. The pylon alone weighs about 1,865 lbs. and its c.g. is located about 3 ft forward of the forward attachment points whereas the pylon and engine together weigh about 13,477 lbs. and the c.g. of the assembly is located about 9 ft forward of the forward attachment points. According to the manual, the sequence shown for the removal of the attach fittings was: The forward upper attach assembly, the forward lower attach assembly, the thrust link, and the aft bolt and bushing.

5/ Technical Report No. 79-1365, Estimating the Probability of Asymmetric Deployment of the Leading Edge Slat System of the DC-10 Aircraft, J. H. Wiggins Company.

American Airlines decided to comply with Service Bulletins 54-48 and 54-59 and to perform the work during a maintenance "C" check at its Tulsa maintenance facility. (See appendix C.) On July 28, 1978, American Airlines issued Engineering Change Order (ECO) R-2693 establishing the maintenance procedures for accomplishing the modifications contained in the service bulletins.

The ECO was developed from the company's experiences during modifications on four VC-10-30's during the spring and fall of 1977, at Los Angeles, California. American Airlines, in accordance with a contract with a foreign carrier, modified four of the foreign carrier's DC-10-30's. The carrier also requested that American Airlines perform the spherical bearing replacement program contained in Service Bulletins 54-48 and 54-59. While establishing the maintenance procedures for the four DC-10-30's, American's maintenance and engineering personnel evaluated the feasibility of raising and lowering the engine and pylon assembly as a single unit using a forklift-type supporting device. This technique would save about 200 man-hours per aircraft, but more importantly from a safety standpoint, it would reduce the number of disconnects (i.e., hydraulic and fuel lines, electrical cables, and wiring) from 79 to 27. American personnel knew that United Airlines was using an overhead hoist to lower and raise the engine and pylon assembly as a single unit.

American Airlines personnel contacted McDonnell-Douglas personnel about this procedure. According to the American Airlines' manager of production for the Hoenig 747 and DC-10 in Tulsa, Oklahoma, who participated in the development of the maintenance procedures, a McDonnell-Douglas field service representative stated that McDonnell-Douglas did not know of any carrier that was removing the engine and pylon as single unit. He said that the field service representative conveyed concern "in reference to clearances to me." However, he assumed that these clearances involved those between the clevis and the fore and aft faces of the aft pylon bulkhead's spherical bearing.

The McDonnell-Douglas field service representative who was contacted by American's personnel stated that he conveyed American's intentions to his superiors. According to him, "Douglas would not encourage this procedure due to the element of risk involved in the remating of the combined engine and pylon assembly to the wing attach points" and that American Airlines' personnel were so advised.

McDonnell-Douglas does not have the authority to either approve or disapprove the maintenance procedures of its customers. American Airlines decided to lower the engine pylon assembly as a single unit and requested that McDonnell-Douglas provide it information concerning the c.g. of the engine and pylon, including the nose cowl and both fan cowl and core cowl thrust reversers, as a single unit. The single unit was to be lowered by a forklift. On March 31, 1977, the McDonnell-Douglas field service representative informed his company that American Airlines "proposes to drop the wing engines, pylon . . . as a single unit package directly on to an engine stand by means of a (forklift)" and then asked for the "C.G. of the pylon in the above described condition." On April 8, 1977, McDonnell-Douglas furnished the data to American.

The evidence showed that, during the time the procedure was in use, several McDonnell-Douglas employees saw the engine and pylon assembly after it was lowered from the wing; however, none of them observed either the actual mating, separating, raising, or lowering of the unit. Those who stated that they had seen the unit resting on the floor of a hangar also stated that they attached no significance to what they saw.

American Airlines used the newly developed removal method to modify the four foreign DC-10-30's. While working on the first aircraft, the maintenance personnel had difficulty removing the forward bulkhead's attach assemblies before removing the aft bearing bolt and bushing. They reversed the procedure and found that removing the aft bolt and bushing first expedited the removal of the forward attach assemblies and the thrust link. The reversed procedure was followed on the remaining three aircraft, and the modification program was completed. The fleet inspection conducted after the accident did not disclose any damage to the upper flanges on these four aircraft. However, the DC-10-30's aft bulkhead design affords more clearance between the bottom of the clevis and the upper spar web fasteners than the DC-10-10's design.

When the decision was made to modify American Airline's DC-10-10 fleet, the procedures used during the DC-10-30 modification program were adopted and incorporated in ECO R-3693. An Hydraulic Forklift, Model 460B, American Airlines No. 3145, was used to raise and lower the engine and pylon assembly. The forklift has a design load capacity of 42,500 lbs. In addition to vertical movement, the lifting forks can be moved forward and backward, they can be yawed from left to right, tilted from left to right, raised and lowered, or moved laterally by moving the mast in the desired direction. A new c.g. for the DC-10-10's engine and pylon assembly was computed by American Airlines and instructions for centering the forklift at the c.g. were incorporated in the ECO. The operator was directed to insert the forks into an engine shipping stand and attach the supported stand to the engine. The ECO stated, "Adjust the engine support adapter aft so that the centerline of the lifting forks are centered with the center hinge on the (engine's) thrust reverser." The lifting forks are 5 ft apart. There was no mark on the forklift denoting the midpoint between the forks; therefore, alignment was not accurate. (See figure 13.)

The engine shipping stand, which can be used to support either a JTSD or CP6-6D engine, was used to support the engine and pylon assembly on the lifting forks. The stand can be adjusted for the different c.g.'s of the two engines, which are denoted by an arrow. The stand has a movable top cradle to which the engine is affixed; the cradle can be moved about 12 inches horizontally. There is also an arrow on the cradle's frame. The arrow on the frame of the cradle must be aligned with the arrow denoting the type engine to be loaded before the engine is placed on the cradle. Eight clamps secure the cradle in position on the stand. However, the cradle can be moved on the stand after the engine has been affixed to it.

'American Airlines' maintenance personnel testified about their experiences with the forklift while handling the engine and pylon assembly. Directions were transmitted to the lift operator either by voice, hand signals, or both. The testimony varied regarding the capability to raise or lower the lifting forks a finite distance. One mechanic said it could be limited to .001 inch; the estimates of others ranged from .25 to .06 inch.

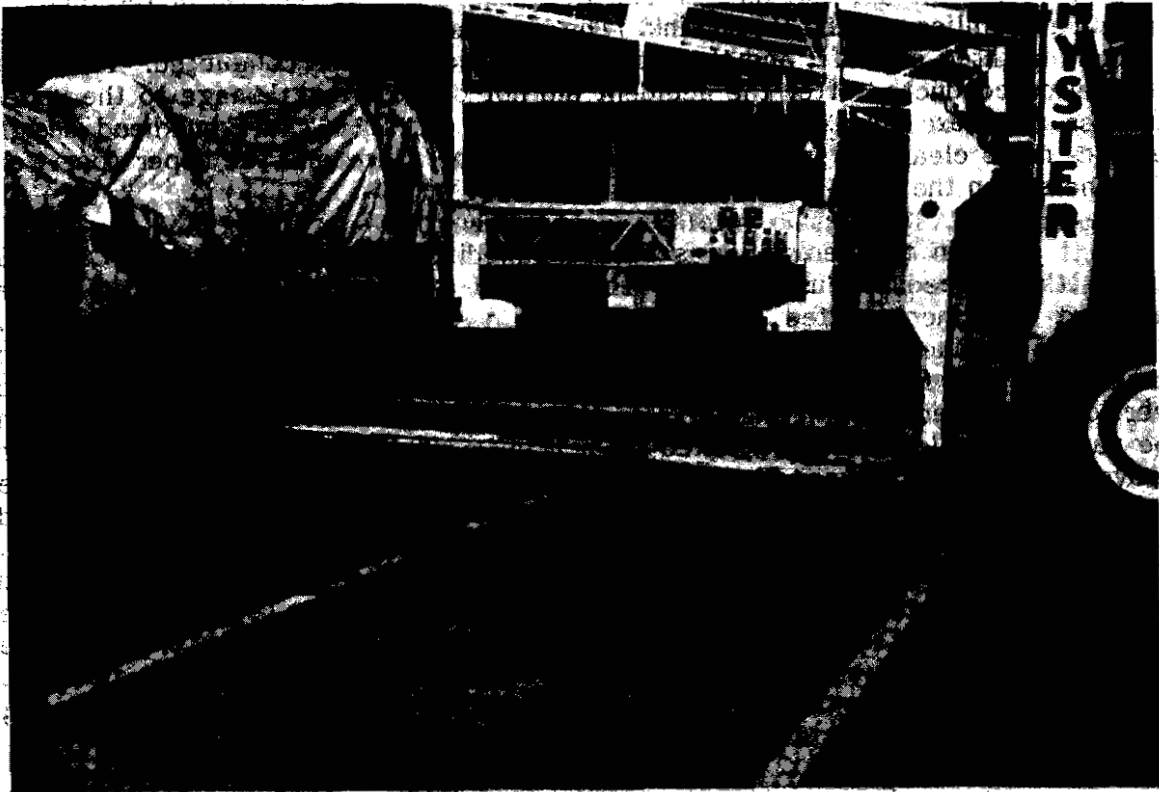

Figure 13. View of forklift and engine stand.



When the full weight of the engine and pylon assembly was on the lifting forks, the pressure gauge reading was 18,000 lbs. Maintenance personnel stated that a 2,000-lb to 3,000-lb pressure bleedoff on the pressure gauge was common; however, they all stated that the lifting forks did not move. Supervisory personnel stated that it was normal for the gauge reading to Meed off 2,000 to 3,000 lbs during a 15-min period without any perceptible load movement. The load remains fixed because of the frictional load on the mast and rollers. Although mechanics testified that the load did not move, they also said that they would manipulate the controls to restore the original reading on the pressure gauge. One mechanic stated that the pylon and engine assembly would "jump" as lowering began. He said the "jerking" motion moved the forks about 1 or 2 inches.

On October 5, 1979, McDonnell-Douglas tested the capability of its Hyster 460B. An 18,000-lb load was placed on the forks, and the equipment was tested for drift down and control capability. The tests showed that an experienced operator was able to move the load in both directions vertically in steps of .187 to .250 inch consistently. When the load was stopped the peak dynamic deflections were (+) .03 to (+) .06 inch about the final rest value. A sink rate of about 1.25 inches per hour was measured during the drift down test.

From March 29 through 31, 1979, the accident aircraft underwent the spherical bearing modification. On April 19, 1979, the forklift's maintenance log contained a writeup which noted, in part, "trouble shooting, forks creeping down under load." There was no record that any corrective action was taken. On May 17, 1979, the log showed "Inspect lift cylinder base per Engineering." There was no record of any findings. On June 20, 1979, the forklift was tested for drift down. An engine-pylon assembly was placed on the lifting forks, and the forks drifted down 1 inch in 30 min. A lift cylinder check valve was found to be defective and was replaced.

The ECO's procedures for detaching the pylon from the wing were as follows: Item F of the ECO called for the removal of the lower attach plug and attaching parts; item G called for removal of the upper attach plug and attaching parts; item H called for removal of the thrust link; and item I--called for removal of the aft bolt and bushing. The ECO did not caution or advise that items F through I must be performed in the sequence listed. According to American Airlines maintenance and supervisory maintenance personnel, since the ECO did not contain such advice, it did not require that items F through I be performed in sequential order. Rather, it merely provided a checklist and signoff sheet to insure that all the steps were performed. Consequently, maintenance personnel saw no harm in performing the modification by first removing the aft spherical bearing's bolt and bushing. Engineering personnel who drafted the ECO were not informed formally of the difficulties experienced in removing the fittings as prescribed.

Mechanics and the inspector who performed the spherical bearing modification on the accident aircraft recounted the operation for the Safety Board. The midnight shift started the modification and removed the aft spherical bearing's bolt and bushing before going off duty on March 30. When the day shift reported for duty, two of the mechanics saw the upper lug of the aft bulkhead come in contact with the bolts attaching the clevis to the wing. These bolts are located at the top of the clevis. The forklift's engine was running at the time, and the

pressure gauge reading was 18,000 lbs. When the crew could not remove the forward attach assemblies, they discovered that the engine stand was misaligned. The clamps holding the cradle to the stand were loosened, and the lifting forks and engine stand were shifted to the left--forward on the engine--until the cradle was properly aligned on the stand. The clamps were then affixed. According to one mechanic, the stand was moved forward about 12 inches. After the stand was realigned, the forward upper and lower attach assemblies were removed, and the engine and pylon assembly was lowered to the hangar floor.

The testimony of the mechanics disclosed that the mechanics' training for this modification was limited to on-the-job training. The inspector had not received any training with regard to this particular modification.

The work cards used to accomplish the modification on the accident aircraft were examined. The inspector's signoff blocks on the ECO's work cards did not contain any requirement for the inspector to inspect the forward or aft attach assemblies after the pylon and engine had been reinstalled on the wing. The work cards included in the ECO showed that after the inspector cleared the pylon for installation, his only inspection requirements were to inspect the connections for integrity and to check for fuel and hydraulic leaks. The work cards also disclosed that there was a nick on the top surface of the pylon aft bulkhead's attach lug, and some of the mechanics recalled seeing the nick.

The inspector stated that chronic problems in the maintenance procedures should be reported on a significant item form. This form is then channeled through maintenance supervision to engineering for action. He said that he thought that the out-of-sequence performance of the tasks in an ECO should be reported to those who formulate the ECO's.

In summary, an overall assessment of the manner in which American Airlines' Engineering developed and then monitored the two ECO's used to replace the pylon's spherical bearings showed they had evaluated the capabilities of the forklift before the decision was made to use the equipment. The engineer who wrote the procedures knew that the forklift was capable of applying high forces. He believed that the movement of the lifting forks could be controlled within "very small fractions" of an inch, but he did not know the resultant rate of movement of these forks in response to a control input. However, since the maintenance personnel were familiar with the forklift, he believed that its use would be more suitable for "our operation."

According to the engineer the procedures of the ECO's and the capabilities of the forklift were analyzed for safety of operation and personnel informally. However, they did not use or perform a formal fault analysis to evaluate the effect on the structure that might result from either personnel error or equipment malfunction. Procedures of this nature, according to the engineer, had never been used to evaluate ECO's. Members of the engineering department observed the prototype procedure on the first two DC-10-30's. However, they only observed the lowering and raising of the engine and pylon as a single unit. They did not witness the removal of the wing to pylon attach assemblies; consequently they were not aware of the difficulties that were encountered, and the subsequent departure from the sequence contained in the ECO.

The maintenance procedures used by Continental Airlines to accomplish SB 54-48 were similar to those of American Airlines. The same type forklift was used to raise and lower the pylon and engine assembly.

On December 19, 1978, the upper flange of the No. 1 pylon aft bulkhead on Continental Airlines DC-10-10, N68041, sustained a crack which penetrated the flange. The upper and lower forward attach assemblies had been removed, and the aft spherical bearing's bolt and bushing had been removed and a pin inserted in its place. When the pin was removed, the aft end of the pylon moved up slightly and a "loud pop described as a pistol shot" was heard. The fracture was discovered, the upper flange repaired, and the aircraft was returned to service.

On February 22, 1979, the upper flange of the No. 3 pylon aft bulkhead in Continental Airlines DC-10-10, N68049, sustained a crack which penetrated the flange. In this case the pylon had been disconnected and the lead mechanic was attempting to clear the aft bulkhead lug from the clevis. He instructed the forklift operator to raise the nose of the engine in order to lower the aft end of the pylon. The forklift operator either misunderstood or inadvertently moved the wrong lever and lowered the nose. The aft end of the pylon was raised with the same results and noise effects described above. Continental Airlines' investigation concluded that both mishaps were maintenance errors and neither was reported to the FAA.

The forklift was checked for drift down after the December mishap and "nothing was found." Several months later the unit was rechecked. Downward drift was found, the malfunction was corrected, and no further difficulties were encountered.

During the postaccident investigation, the maintenance procedures of all United States carriers operating DC-10 series aircrafts were inspected. The evidence disclosed that United States carriers had removed and reinstalled 175 pylon and engine assemblies. Eighty-eight of these operations involved the lowering and raising of the pylon and engine as a single unit. Of these 88, 12 were lowered and raised with an overhead crane. The remaining 76 were lowered and raised with a forklift. The nine situations wherein impact damage was sustained and cracks found involved the use of the forklift. \*

#### 1.17.2 Federal Aviation Administration Reporting and Surveillance Procedures

Air carrier reporting requirements are established in 14 CFR Part 121, and are basically contained in two regulations. 14 CFR 121.703 establishes the mechanical reliability report (MRR) system. The regulation requires a certificate holder to report "the occurrence or detection of each failure, malfunction, or defect concerning . . . ." The regulation contains 16 paragraphs setting forth the conditions that must be reported. 14 CFR 121.703(14) requires the carrier to report "Aircraft structure requiring major repair" and paragraph (15) requires the carrier to report "cracks, permanent deformation, or corrosion of aircraft structures, if more than the maximum acceptable to the manufacturer or the FAA." According to the FAA, the MRR system is, for the most part, limited to service-related problems and to failures and malfunctions which have occurred after the aircraft's engines are started with the intent for flight and while they are running. In response to a question as to whether paragraph (15) would apply to the

December 1978, and February 1979, upper flange cracks at Continental Airlines, a FAA air carrier maintenance specialist stated that historically and traditionally the MRR procedures have always dealt with service-related problems. He said that under the MRR concept "we would not consider it because it was not a service related problem."

14 CFR 121.707, Alteration and Repair Reports reads as follows:

- (a) Each certificate holder shall, promptly upon its completion, prepare a report of each major alteration or major repair of an airframe, aircraft engine, propeller, or appliance of an aircraft operated by it.
- (b) The certificate holder shall submit a copy of each report of a major alteration to, and shall keep a copy of each report of a major repair available for inspection by, the representative of the Administrator assigned to it.

The authority for an air carrier to perform maintenance is derived from several sources. Pursuant to the provisions of 14 CFR 21, Subpart M, an air carrier may be certified by the FAA as a Designated Alteration Station (DAS), as were American and Continental Airlines. In accordance with this certification, either carrier could issue supplemental type certificates and perform its own alterations without prior FAA approval; however, the required reports must be submitted to the FAA.

14 CFR 121.379 also contains authorization for a Part 121 certificate holder to perform maintenance and alterations. This section reads, in part, as follows:

- "(a) A certificate holder may perform, or it may make arrangements with other persons to perform maintenance, preventive maintenance, and alterations as provided in its continuous airworthiness maintenance program and its maintenance manual. . . .
- "(b) A certificate holder may approve any aircraft, airframe, aircraft engine, propeller, or appliance for return to service after maintenance, preventive maintenance, or alternations that are performed under paragraph(a) of this section. However, in the case of a major repair or alteration, the work must have been done in accordance with technical data approved by the Administrator."

The investigation showed that there were large differences in the interpretation of what constituted a major alteration or repair despite the guidelines contained in the Federal regulations. 14 CFR 1.1 defines a major repair and alteration as follows:

"A major alteration means an alteration not listed in the aircraft, aircraft engine, or propeller specifications--(1) That might appreciably affect weight, balance, structural strength, performance, powerplant operation, flight characteristics or other qualities affecting airworthiness; or (2) That is not done according to accepted practices or cannot be done by elementary operations.

"Major Repair' means a repair: (1) That, if improperly done might appreciably affect weight, balance, structural strength, performance, powerplant operation, flight characteristics, or other qualities affecting airworthiness, or (2) That is not done according to accepted practices or cannot be done by elementary operation."

The FAA air carrier maintenance specialist stated that the classification of major alteration or repair related to the requirement that either or both be accomplished in accordance with approved data. It is a method of protecting the type certificate design and of assuring that the repair or alteration does not change or modify a design feature.

Continental Airlines' principal maintenance inspector stated that there are no "clear cut rules" for interpreting the regulation. "It has been argumentative for 70 years that I know (sic) it!" Although it was his opinion that the major part of the bulkhead was a structurally significant item, he did not consider the upper flange part of the bulkhead.

The FAA team investigating maintenance and airworthiness procedures after the accident found that FAA regulations and guidance did not adequately define what constitutes a major repair. The team found that the repairs made to five pylons, including the two upper flanges at Continental Airlines, constituted major repairs since critical structure was involved. Therefore, the team concluded these repairs should have been submitted to the FAA for approval. 6/

The FAA principal maintenance inspectors are responsible for the surveillance of the maintenance activities and procedures of those air carriers assigned to their office. The principal inspector for Continental Airlines was not aware of the cracks sustained in the upper flanges of the two Continental aircraft during the modification procedure, nor did he know when the carrier began the modifications contained in Service Bulletins 54-48 and 54-59.

The principal maintenance inspector at American Airlines' Tulsa Maintenance Base was also the chief of the Tulsa Air Carrier District Office, and had served 7 years as chief. However, he had been principal inspector for American Airlines since January 15, 1979. The principal maintenance inspector did not know that American Airlines was removing the pylon and engine assembly as a single unit until May 30, 1979. In accordance with a request from his office sometime before May 23, 1977, American Airlines had been requested to revise its ECO distribution to the Tulsa Air Carrier District Office to "include cover sheets only, without the detailed technical data." Thus, the FAA received only the cover sheet of ECO K-2693. The material containing the maintenance procedures was retained by the carrier, and the Tulsa Air Carrier District Office did not conduct any checks on the pylon maintenance.

6/ Report to the Administrator of the Federal Aviation Administration in the Matter of Maintenance and Airworthiness Procedures Concerning DC-10 Aircraft Operated By American Airlines, Continental Airlines, and six other U.S. Air Carriers.

The cover sheet of ECO R-2693 classified the repairs as minor. The principal inspector said that the cover sheet also contained the FAA-approved Service Bulletins 54-48 and 54-59. Therefore, he had no reason to either doubt the classification or the carrier's capability to carry out the repair. In his opinion, there was no reason to expend manpower in surveillance of a minor repair.

Evidence developed during the investigation showed that FAA approval of a service bulletin indicates to the operator that the change in design included in the bulletin has been approved by the FAA, thereby relieving the operator of the necessity of obtaining his own design approval. However, the FAA approval does not apply to the maintenance procedures incorporated in the service bulletin.

### 1.17.3 DC-10 Certification

The DC-10's pylon structure, flight controls, hydraulic system, and electrical system were certificated in accordance with the applicable provisions of 14 CFR Part 25 effective February 1, 1965, as amended, and Special Condition No. 25-18-WE-7, January 7, 1970, as amended. (See appendix E.)

Special Condition No. 25-18-WE-7, Docket No. 10058, was issued pursuant to 14 CFR 21.16 because the airworthiness regulations of Part 25 did not contain adequate or appropriate safety standards for the aircraft because of a novel or unusual design feature. In the case of the DC-10, this feature was the fully powered flight control system.

The function of assessing compliance with certain aspects of the type certification was delegated to FAA Designated Engineering Representatives who were employed by McDonnell-Douglas. Such representatives are designated by the FAA to represent the Administrator pursuant to Section 314 of the Federal Aviation Act of 1958 and 14 CFR 183.29. According to FAA and McDonnell-Douglas witnesses, the workload involved in the certification process far exceeds the FAA's manpower resources.

The chief of the FAA's Western Region Aircraft Engineering Division stated that during the type certification process the review of the basic data and the most critical tests are reserved to the FAA itself. The fault analysis data are reviewed and approved by FAA engineering personnel. He also said that little delegation is done in the flight test area. The chief of the FAA's Western Region Flight Test Branch stated that the DC-10's type certification required 500 hrs of flight testing, and 90 percent of that time was flown by FAA test pilots.

The principle underlying the regulations concerning the certification the aircraft's systems was redundancy. This principle contemplates that, while each critical component of a system is required to perform functions within the design envelope of the aircraft, its failure will nevertheless be assumed. Accordingly, appropriate analyses and tests are required to insure that sufficient redundancy exists so that after a single failure of any component or element its functions will be distributed to other components capable of assuming them safely.

The criteria for the certification of the aircraft's pylon and its components were contained in 14 CFR 25.571, "Fatigue Evaluation of Flight Structure". (See appendix E.) This regulation required the manufacturer to show, by analysis, tests, or both, that those parts of the structure whose failure could result in catastrophic failure of the aircraft would be able to withstand the repeated loads of variable magnitude expected in flight, that catastrophic failure or excessive structural deformation that could adversely affect the flight characteristics of the aircraft are not probable after fatigue failure or obvious failure of a single principal structural element, and that after this type of failure of a single principal structural element, the remaining structure must be able to provide an alternate load path. The regulation only required that fatigue damage be evaluated. The chief of the FAA's Western Region Aircraft Engineering Division testified that under normal loading there was "extremely low stress" on the upper flange and "the possibility of fatigue was believed to be extremely low, low enough that you would not consider fatigue failure.

Because all flight controls were hydraulically actuated and the basic regulations did not cover this configuration, Special Condition No. 25-18-WE-7 was formulated. However, the trailing edge flap and leading edge slat systems were certified under the basic regulations.

The leading edge slat system was certified in accordance with 14 CFR 25.671--general control system requirements, 14 CFR 25.675--control system stops, 14 CFR 25.685--detailed design requirements for flight control systems, and 14 CFR 25.689--cable system design. The chief program engineer at McDonnell-Douglas said that the flap control requirements of 14 CFR 25.701(a) were also applied to the slats. Paragraph (a) states:

"The motion on the flaps on opposite sides of the plane of symmetry must be synchronized unless the aircraft has safe characteristics with the flaps retracted on one side and extended on the other."

Since the left and right inboard slats are controlled by a single valve and actuated by a common drum and the left and right outboard slats receive their command from mechanically linked control valves which are "slaved" to the inboard slats by the followup cable, the synchronization requirement was satisfied. However, since the cable drum actuating mechanisms of the left and right outboard slats were independent of each other, the possibility existed that one outboard slat might fail to respond to a commanded movement. Therefore, the safe flight characteristics of the aircraft with asymmetrical outboard slats were demonstrated by test flight. These flight characteristics were investigated within an airspeed range bounded by the limiting airspeed for the takeoff slat positions --260 kns--and the stall warning speed; the flight test did not investigate these characteristics under takeoff conditions. In addition, a slat disagree warning light system was installed which, when illuminated, indicated that the slat handle and slat position disagree, or the slats are in transit, or the slats have been extended automatically.

The program engineer stated that the commanded slat position is held by trapped fluid in the actuating cylinder, and that no consideration was given to an alternate locking mechanism. The slats' hydraulic lines and followup cables

were routed as close as possible to primary structure for protection; however, routing them behind the wing's front spar was not considered because of interference with other systems.

The branch chief of the Reliability and Safety Engineering Organization of the Douglas Aircraft Company described the failure mode and effects analysis (FMEA) and fault analysis. The witness indicated that the FMEA was a basic working document in which rational failure modes were postulated and analyzed; vendors and subcontractors were requested to perform similar analyses on equipment they supplied to McDonnell-Douglas. Previous design and service experience was incorporated in the initial DC-10-10's FMEA's and analyses were modified as the design progressed. The FMEA's were synthesized to make fault analyses, which were system-oriented summary documents submitted to the FAA to satisfy 14 CFR 25.1309. The FAA could have requested and could have reviewed the FMEA's.

The basic regulations under which the slats were certified did not require accountability for multiple failures. The slat fault analysis submitted to the FAA listed 11 faults or failures, all of which were correctable by the flight crew. However, one multiple failure--erroneous motion transmitted to the right-hand outboard slats and an engine failure on the appropriate side--was considered by McDonnell-Douglas in its FMEA. The FMEA noted that the "failure increases the amount of yaw but would be critical only under the most adverse flight or takeoff conditions. The probability of both failures occurring is less than  $1 \times 10^{-10}$ ." The evidence indicated that this FMEA was not given to the FAA formally but was available for review.

Special Condition No. 25-18-WE-7 requires the applicant to show that the aircraft is capable of continued flight and landing after "any combination of failures not shown to be extremely improbable." According to FAA witnesses, the definition for extremely improbable that they have been using and have been accepting for a number of years is one chance in a billion, or  $1 \times 10^{-9}$ .

The regulation, 14 CFR 25.207, requires that "Stall warning with sufficient margin to prevent inadvertent stalling with the flaps and landing gear in any normal position must be clear and distinctive to the pilot in straight and turning flight." The warning can be furnished through the inherent aerodynamic qualities of the aircraft or by a mechanical or electronic device. A visual warning device is unacceptable. The warning must begin at a speed exceeding the stall speed or the minimum speed demonstrated "...by seven percent or at any lesser margin if the stall warning has enough clarity and duration, distinctiveness, or similar properties." The flight testing of the UC-10 disclosed that the inherent aerodynamic stall warning exceeded the required regulatory margin in all flap configurations until the landing flap configuration ( $50^\circ$ ) was reached. According to the chief of the FAA's Flight Test Branch, with  $50^\circ$  flaps the stall buffet still precedes stall onset, "but it occurs quite close, within just a few knots of the aerodynamic stall." Since the margin did not meet the regulatory criteria, a stall warning system was installed.

The initial DC-10 design incorporated the left (No. 1) and right (No. 2) autothrottle speed computers (AT/SC) as stall warning computers. The No. 1 and No. 2 AT/SC's were powered by the No. 1 and No. 3 a.c. buses, respectively. The



No. 1 AT/SC received inputs from the left inboard flap position transmitter, from a position sensor on the left outboard slat section, and the left angle-of-attack sensor. The No. 2 AT/SC received its inputs from counterpart sensors and components on the right side of the aircraft. The stickshaker motor was mounted on the captain's control column and was powered by the No. 1 d.c. bus. A stall signal from either computer would actuate the stickshaker motor. The design contained provisions for a second stickshaker motor to be mounted on the first officer's control column; however, the second stickshaker was a customer designated option. The accident aircraft's stall warning system did not incorporate the second stickshaker described above.

The December 1, 1978, revision of 14 CFR 25.571 retitled the regulation "Damage-Tolerance and Fatigue Evaluation of Structure." The fail-safe evaluation must now include damage modes due to fatigue, corrosion, and accidental damage. According to the manufacturer, the consideration for accidental damage was limited to damage which can be inflicted during routine maintenance and aircraft servicing.

The FAA's Aircraft Engineering Division chief also stated that while the recertification process disclosed a deficiency in design data on file with the FAA it did not disclose any deficiency in the pylon's design. In some cases, the manufacturer had the data on file. In one instance, the data concerning the alternate load paths for thrust loads following a thrust-link failure were questioned. The manufacturer's analysis assumed the loads would be carried by the forward bulkhead. The manufacturer also stated that the thrust loads could be carried out by the aft bulkhead. The FAA asked McDonnell-Douglas to substantiate this claim, and they did so successfully.

As a result of the postaccident simulator tests, an AD was issued which required, as a condition for reinstatement of the type certificate, that the aircraft be operated either with both AT/SC's installed and operating, or with a modified single AT/SC that would receive slat information from both sides of the aircraft. (See appendix F).

On July 30, 1979, a Notice of Proposed Rule Making (NPRM), docket No. 79WE-17AD, was issued. (See appendix F.) The NPRM contained an AD which will require that the stall warning system incorporate two AT/SC's and two stickshaker motors, and that the AT/SC's be modified to receive position information from both outboard wing leading edge slat groups.

#### 1.17.4 DC-10 Maintenance and Inspection Programs

During the investigation, the development of the DC-10 maintenance program was studied to determine the methods used to establish the aircraft's maintenance program and the inspection requirements for the wing pylons. The program guidelines were embodied in the "Airline Manufacturer Maintenance Program Planning Document, MSG-2." The document was formulated by a working group composed of representatives of user air carriers, McDonnell-Douglas, and one or more FAA observers. The document was then submitted to the FAA Maintenance Review Board where FAA observers and engineers met to evaluate the proposals. The review board issued a report which prescribed the minimum maintenance program for DC-10 operators and required a review of the specific work programs of each operator by its FAA principal maintenance inspector to assure conformance with the program.

When an aircraft is delivered to an operator, the manufacturer must, by regulation, furnish the operator with a maintenance manual (14 CFR 25.1529). The manual must contain the essential information and procedures necessary to maintain the aircraft.

The maintenance programs for modern aircraft are comprised generally of three primary maintenance processes known throughout the industry as "hard-time," "condition-monitoring," and "on-condition." Hard-time is a preventive maintenance process which requires that an appliance or part be overhauled or replaced after a specific period of service. This process is generally applied to parts which are subject to predictable wear, such as engines or engine components. Condition-monitoring is a process which applies to components, the output of which can be monitored to detect degradation in performance indicating that the maintenance is required. When applying the condition-monitoring process, the potential effect of an unpredicted failure of the part is also considered.

The airworthiness of most of the structural elements of the aircraft is maintained by the on-condition maintenance process. This process requires that a part be periodically inspected against some physical standard to determine whether it can continue in service. Thus, the maintenance program established for the aircraft includes specified inspection requirements for each structural element. The inspection interval depends upon an analysis which considers the susceptibility of the part to fatigue damage, corrosion, and crack propagation. The degree of redundancy and the accessibility for inspection are also considered.

The on-condition process also incorporates the principle that similar parts behave in similar ways. Thus, if a part is analyzed to be relatively resistant to damage throughout the anticipated life span of the aircraft, an inspection of that part on every aircraft—a 100-percent inspection—may not be required; the part will be placed in a sampling inspection program and a statistically representative sample of the parts on the entire fleet of aircraft will be inspected. If a problem is detected during the sampling inspection program, the FAA's service difficulty reporting program incorporates the mechanism whereby revised inspection requirements can be evaluated and levied on the operators for application to the entire fleet of aircraft. The on-condition maintenance program, thus, is intended to be a conservative method to verify the design resistance to fatigue or corrosion damage during the aircraft's service life. However, the maintenance programs are not designed to detect damage resulting from improper manufacturing processes or maintenance.

During the investigation, the Safety Board examined closely the sampling inspection program for the wing pylon. The program, sampling base, and inspection frequency were based upon factors, including projected aircraft life as well as structurally significant items and their resistance to fatigue and corrosion.

The maintenance document (MSG-2) defined structurally significant items as "those local areas of primary structure which are judged by the manufacturer to be relatively the most important from a fatigue or corrosion vulnerability or from a failure defect standpoint," and it required that these items be classified as to relative importance. The classification and ratings of these items were based upon the fatigue, corrosion, and crack-propagation resistance properties of the structure. These properties were analyzed on the basis of fatigue testing, special tests for crack growth rates, and the company's previous experience with the aircraft structure.

42

The structurally significant items with a classification or rating number of 1 or 2 (indicative of a lower overall level of structural integrity) would probably be placed on a 100-percent inspection program. The 100-percent program would require that these items be inspected on every aircraft at an interval which is determined by testing and analysis. Structures classified as 3 or 4 would probably be sampled. The sampling program required the inspection of some structurally significant items on only a specified fraction of an operator's fleet and at a pre-determined interval.

The initial DC-10 program required 100-percent inspection for some items and placed others on a fractional sampling program. The inspection frequency for some items on the 100-percent program was based on their classification. Structurally significant items (SSI), classified as a Class-1 SSI, were to be inspected on all aircraft every 4,000 hrs, Class-2 SSI's every 8,000 hrs, and a Class-5 SSI every 20,000 hrs. In the fractional sampling program, only a certain proportion of a carrier's aircraft was to be inspected to monitor the condition of a structurally significant item. Thus, only 1/5 of a carrier's aircraft population was to be inspected at a 20,000-hr interval to monitor a Class-1 SSI, whereas 1/12 of its aircraft population was to be inspected at a similar interval to monitor a Class-5 SSI. For example, under the sampling program, the upper attach lug of the pylon aft bulkhead was on a 100-percent inspection program, while the aft bulkhead's upper flange and other portions of the bulkhead were on a fractional sampling program. The upper attach lug is designed to fail in the event of a wheels-up landing and thus prevent fuel tank rupture; accordingly, the lug was not overdesigned and is subjected to significant stresses which places it in a class requiring 100-percent inspection every 4,000 hrs. In contrast, the rest of the bulkhead is subjected to relatively low stresses; therefore, it is considered to be less susceptible to difficulty in service and suitable for sample-type inspection.

#### 1.17.5 Manufacturer's Service Bulletin and Customer Service Programs

The FAA's service difficulty reports and McDonnell-Douglas service bulletins were reviewed to determine if any chronic difficulties related to aft bulkhead cracking had existed before the accident. The service difficulty reports indicated that some problems existed with wing spherical bearing attach fittings. These problems were not anticipated during design and did not develop until the aircraft was placed into service. As a result, programs were launched to replace the old spherical bearings with stronger and more efficient bearings through Service Bulletin 54-48 and 54-59.

McDonnell-Douglas maintains a customer support program. Under this program, the company maintains field service representatives at the operators' maintenance facilities and receives reports from operators concerning service difficulties encountered by its aircraft.

During December 1978, when Continental Airlines cracked the forward flange of an aft bulkhead during its bearing modification program, McDonnell-Douglas provided the operator with an engineer product specialist to assist it in repairing the flange. The product engineer specialist testified that he was responsible for, investigating, analyzing, and interpreting customer reports regarding unsatisfactory performance and service failure of the aircraft structure.

He was also responsible for supplying any necessary corrective procedures. At the Safety Board's public hearing the engineer specialist testified that he did not see the pylon and engine assemblies raised or lowered, that he assisted the carrier in making the required repairs, and that he was told that the carrier "cracked the part while lowering the pylon. And that was the extent of the discussion."

According to the engineer, about 1 week later he wrote a short paragraph describing the problem and its disposition for inclusion into a company Operational Occurrences Report. This was published on January 5, 1979, as part of Report No. 10-7901 and read as follows

"An operator has reported a case of damage to the wing pylon aft monoball (spherical) bearing support bulkhead, P/N AUB7002-1. This apparently occurred when the pylon shifted while it was being lowered. The aft end of the pylon rotated up, and the forward lug of the wing clevis fitting contacted the upper horizontal flange of the support bulkhead. The flange on the support bulkhead was sheared off for most of its length; necessitating removal of the support bulkhead from the pylon for repairs."

Operational Occurrence Reports are distributed to all DC-10 operators. American Airlines did not recall receiving this Operational occurrence Report, but Continental Airlines found it in its service library after the accident. The Operational Occurrence Report contained reports concerning all types of mishaps, system malfunctions, and structural defects that the manufacturer believed would be of interest to his customers. The report which contained the description of the bulkhead damage also contained reports of an air conditioning pack malfunction, a lightning strike, collapse of a passenger loading stand; and a flight attendant injury suffered in the galley cart lift.

14 CFR 21.3 establishes the responsibility of the holder of a type certificate to report failures, malfunctions, or defects to the FAA. The regulation requires a certificate holder to report any defect in any product or part it manufactures and that it has determined resulted in any of the occurrences set forth in the regulation. The primary structural defects the certificate holder is required to report are limited to those caused by "any autogenous condition (fatigue, understrength, corrosion, etc.)." Further, 14 CFR 21.3 (d)(i) states that the reporting requirements do not apply to failures, malfunctions, or defects that the certificate holder "determines were caused by improper maintenance."

#### 1.176 Manufacturer's Production Line Procedures

The production line procedures of the facilities producing the wing pylon assembly were investigated, including the installation of shims on the upper surface of the horizontal flange on the accident aircraft. According to the McDonnell-Douglas' Vice President for Quality Assurance, the .063-inch-thick shims installed on the upper shoulders of the upper flange were standard shims. He said that these shims can be installed any place they are needed to reduce a clearance. No approval is needed since the procedure is authorized by Douglas Process Standard 2.70.2 (DPS 2.70.2).

The 10-inch-long, .050-inch-thick shim installed on the accident aircraft was not a standard shim and, according to McDonnell-Douglas engineers who testified at the Safety Board's public hearing, written authorization was required to use it. Such an authorization is processed through the company's engineering liaison group and reviewed by Stress liaison personnel of the structural analysis group. Rejection and Disposition Item A081757 had been issued authorizing the insertion of the shim, and had been signed by an engineer in the liaison group. Although a McDonnell-Douglas engineer assumed that the proper stress analysis had been performed before the issuance of the Rejection and Disposition Item, there was no signature to indicate specifically that the analysis had been done, nor was space provided for such a signature.

The evidence disclosed that 23 pylons were placed into service with shims on the top of the upper flange. The clearance problem on the upper flange began with fuselage No. 15 and continued through fuselage No. 36 (the accident aircraft was fuselage No. 22). A McDonnell-Douglas investigation disclosed that the clearance problem was the result of a tooling malfunction, and it was resolved by repositioning locator pins on the tooling jigs.

In October 1974, the pylon production line was transferred from McDonnell-Douglas' Santa Monica, California, location to the Huntington Beach, California, facility. The transfer was made at fuselage No. 208. During an inspection conducted after the accident, 31 aircraft were found to have had wing pylons with loose, failed, or missing fasteners. Fifteen of these aircraft were between fuselage No. 170 and 208. Six of these 15 aircraft had more than 5 loose or missing fasteners. Of the other 16 aircraft, 1 had 7 and another had 5 loose or missing fasteners; the remaining 14 aircraft had less than 5 loose or missing fasteners. McDonnell-Douglas personnel believed that one of the causes of this production breakdown was the effect the impending transfer of the production line had upon worker experience, morale, and productivity.

The investigation of the upper spar web cracks and fasteners found on United Airlines DC-10, N1827U, fuselage No. 196, also showed that its problems probably were traceable to production line procedures at McDonnell-Douglas. The damage on the United Airlines DC-10 was limited to the cracking of the upper spar web and failure of 26 fasteners. There was no damage to the aft bulkhead flange. An examination of the aircraft's history showed that it had not been exposed to any hard landings; however, it had experienced an engine failure and had been subjected to vibrations resulting from the windmilling of an unbalanced engine during 1 hr 20 min of flight.

Engine vibration testing was conducted at the General Electric facility at Pccblcs, Ohio, to investigate the possibility that a significant imbalance accompanied with windmilling for 80 min was a possible or plausible explanation of the damage. The results were negative.

A metallurgical examination of the spar and fasteners showed evidence of high-cycle, low-stress fatigue along the majority of the upper spar web fractures as well as fatigue cracking in 26 of the 29 fasteners. Only one fastener had failed due to overload. Evaluation of the data indicated that there was no similarity to the damage noted on the accident aircraft; that no single event explains the damage on the United DC-10's upper spar web; and that the damage occurred over a long period of time and was likely to have initiated from

manufacturing discrepancies. Fuselage No. 196 was among those manufactured at the Santa Monica plant where the greatest frequency and number of production discrepancies to the fasteners occurred.

#### 1.17.7 DC-10 Hydraulic and Electrical Systems

Hydraulic power is provided by three hydraulic systems. Each system is powered by two engine-driven hydraulic pumps. Additionally, two electric auxiliary pumps are provided in system No. 3. Emergency hydraulic power is available from one of these auxiliary pumps when powered by the air-driven generator. Two reversible motor-pumps can transfer power from an operating system to an unpressurized system if an engine fails. In addition, two nonreversible motor-pumps can provide a similar transfer of power to certain components of the night control system.

The three hydraulic systems normally operate independently of each other and are pressurized by their respective engine-driven pumps. The systems power the flight controls, horizontal stabilizer, landing gear, brakes, and nosewheel steering. The two electric auxiliary pumps in hydraulic system No. 3 are primarily for ground use when the engines are shut down; however, auxiliary hydraulic pump No. 1 can be used as an emergency pressure source for the night controls if all three engines are lost. This can be done in flight by deploying the air-driven generator which will provide electrical power to operate the pump.

The system 1-3 and system 2-3 reversible motor pumps are installed to transfer pressure from an operating hydraulic system to an unpressurized hydraulic system; pressure can be transferred in either direction. No fluid transfer takes place--the transfer of energy is mechanical. Control switches for these pumps are provided on the flight engineer's panel. If the fluid in the reservoir of either the operating system or the system being pressurized falls below a preset minimum, that motor-pump combination will automatically stop operating. Two nonreversible motor pumps are installed in the stabilizer and rudder hydraulic systems to provide backup hydraulic power should the normal power source fail.

Under normal operating conditions, hydraulic power is provided by the two engine-driven pumps in each system. The reversible motor pump controls are in the "arm" position to provide automatic operation in the event of engine failure, and the rudder standby power control switch is in the "arm" position to provide automatic standby power for the rudders if the No. 1 or No. 2 hydraulic system fails.

Except for the spoilers and the upper and lower rudders, each flight control surface is powered by two hydraulic systems. Hydraulic system No. 1 powers the No. 2 and No. 4 spoiler panels on each wing; hydraulic system No. 2 powers the No. 1 and No. 5 spoiler panel on each wing, and hydraulic system No. 3 powers the No. 3 spoiler panel in each wing. The landing gear is powered by the No. 3 hydraulic system.

The lower rudder is powered by hydraulic system No. 2, and its backup power is provided by the 3-2 nonreversible motor pump. The upper rudder is powered by hydraulic system No. 1. Backup power is provided by the 2-1 nonreversible motor pump. Each backup power system has its own independent reservoir and fluid. Consequently, a complete loss of hydraulic fluid in system No. 1 will not affect the operation of the backup system.

2/10

The 2-1 nonreversible motor pump also supplies backup power to the horizontal stabilizer, and the operation of the stabilizer trim reduces the fluid flow and pressure available to operate the upper rudder. However, the check valves in the rudder actuator will prevent a drop in hydraulic system pressure from causing a loss of any rudder deflection being held.

When the No. 3 hydraulic system's lines to the outboard slat actuator were severed, during pylon separation, hydraulic fluid began to be lost. The rate of loss was dependent upon the positioning of the slat control valve, and the amount of pinching of the hydraulic lines at the point of severance. According to the chief program engineer for DC-10 design, under the worst case--the control valve wide open and no pinching of the lines--it would require 4 minutes to deplete the reservoir. He further estimated that over a 30-sec to 40-sec period after the rupture there would be no pressure loss and that the retraction of the landing gear would not create significant pressure drain during the time the system remained operable. The witness testified that the hydraulic system was certified in accordance with the existing regulations and compliance with 14 CFR 25.1309 was shown by FMEA and flight testing.

During the early service history of the aircraft, some difficulties with the nonreversible motor pumps were encountered. The pumps were of a new design, and the FMEA's did not predict the in-service difficulties which occurred early in the aircraft's service history. The pumps were redesigned, and the malfunction has not recurred.

According to the witness, there has been only one incident of dual hydraulic system failure. That failure resulted from a tire failure; however, the aircraft was landed safely with one hydraulic system.

The DC-10 electrical system is normally powered by three engine-driven generators. Portions of the system may be powered by a battery and an air-driven generator. The electrical generating system is a.c. with necessary d.c. power provided by transformer rectifier units or a battery. The generators will function either paralleled, unparalleled, or isolated, and each generator can supply enough power to operate all essential electrical systems.

A battery and static inverter combination can provide about 30 min of emergency a.c. and d.c. bus power for the captain's flight instruments, essential communication, and navigation equipment when normal sources are inoperative. The battery and static inverter operations can be obtained by rotating the emergency power switch on the pilot's overhead panel to the "on" position.

Three independent a.c. channels provide power to associated generator buses, which feed associated main a.c. buses. The channels are paralleled through the a.c. tie buses which permits assumption of electrical loads by any functioning generator or generators. The a.c. system is operated normally in parallel with the bus tie relays closed. Two emergency a.c. buses are powered by a.c. buses 1 and 3.

The four transformer rectifier units, which are powered from designated a.c. buses, are the primary sources of d.c. power. Except for transformer rectifier No. 2B, which is powered from the a.c. ground service bus

during ground operation, the other three transformer rectifier systems are similar to their counterpart a.c. systems. However, the d.c. buses are electrically isolated during normal operation.

Protective circuitry automatically isolates faulted buses or components from the other parts of the system. If the protective circuitry senses a generator fault, such as an under voltage condition, the generator relay will open and isolate the generator from its bus; the rest of the system will be powered by the remaining generators. However, if a bus fault is sensed, such as a differential current, the bus tie relay will open and isolate the generator and its associated a.c. buses from the a.c. tie bus. If this occurs, the protective circuitry will also engage a lockout mechanism to protect the remaining buses from damage. The lockout mechanism can be released and power restored to the bus, provided the fault has been cleared by appropriate actions by the flight engineer on his electrical and generator reset panel located at the top of the upper main circuit breaker panel. When he is positioned for takeoff, the flight engineer cannot reach this panel. He must reposition his seat to face his panel, release his safety belt, and get out of his seat to reach the switches. Company procedures only authorize one attempt to restore power. This procedure is not classified as an emergency procedure; it is an "abnormal procedure." The procedure does not contain any immediate action items which must be done without a checklist.

The loss of the No. 1 engine and its associated generator causes a loss of many aircraft systems and instruments. Among these are: The captain's flight instruments, the left stall warning computer, the stickshaker motor, No. 1 engine's instruments, the slat disagree warning light system, portions of the flight control indicating system, portions of the DFDR sensors, and the CVR. In addition to these losses, the flightcrew would be presented with numerous warning lights. The caution and master warning lights on the glare shield would be illuminated. Hydraulic and electrical malfunction lights would be illuminated on the annunciator panel and on the flight engineer's panel. Power to the left a.c. and d.c. emergency buses could have been restored by rotation of the emergency power switch to the "on" position. This action would have powered the left a.c. and d.c. emergency buses and restored the operation of the captain's instruments as well as some of the engine instruments.

#### 1.17.8 Flightcrew Procedures

American Airlines Operating Manual contains the recommended procedures for operating the DC-10 aircraft and its personnel are required to comply with the procedures set forth therein. Since the failure of the pylon and engine did not occur until after V<sub>1</sub>, only those company procedures relating to continued flight were examined. These procedures are contained in the Emergency Procedures Section of the Operating Manual.

The Emergency Procedures Section is prefaced with the following guideline:

"The procedures on the Emergency Checklist are those where immediate and precise action on the part of the crew will substantially reduce the possibility of personal injury or loss of life.



The emergency procedures in this section are presented as the **best** way to handle these specific situations. They represent the safest, most practical manner of coping with emergencies, based on the judgment of the most experienced Pilots and F/E's, the FAA approved procedures, and the **best** available information. If an emergency arises for which these procedures are not adequate or do not apply, the crew's best judgment should prevail."

The manual also provides guidelines as to how the flightcrew will use the emergency checklist. The manual states, in part:

The checklist is a tool provided to minimize usually **hasty** and perhaps **improper** action. Though all checklist procedures are not required to be committed to memory it is expected that **all** crewmen understand fully each and every procedure.

The nature and seriousness of any given emergency cannot always be immediately and accurately determined. As a **professional** you will always fly the aircraft and/or immediately correct the obvious prior to any specific reference to the cockpit checklist. Some of the items which fall into the category of attending to the obvious are donning of  $O_2$  masks and goggles, establishing interphone communications, resetting the fire alarm warning, etc.

The emergency procedure for a takeoff engine failure, flaps  $15^\circ$  or less or  $22^\circ$ , states, in part:

"This procedure assumes indication of engine failure where the takeoff is continued. Each takeoff should be planned for the possibility of an engine failure. Normal takeoff procedures ensure the ability to handle an engine failure successfully at any point.

If an engine failure occurs when making a Standard Thrust takeoff, Standard Thrust on the remaining engines will produce the required takeoff performance. If deemed necessary, the remaining engines may be advanced to Maximum Take-Off Thrust.

Speed.. ..... CLIMB OUT AT  $V_2$  UNTIL REACHING  
800 FEET AGL OR OBSTACLE CLEARANCE  
ALTITUDE, WHICHEVER IS HIGHER  
THEN LOWER ROSE AND ACCELERATE"

The Operating Manual's discussion of the procedure contained an annotated profile drawing of the takeoff. (See figure 14.) The annotations accompanying the profile sketch state (after the aircraft is airborne), "Continue rotation to  $V_2$  (Deck angle  $12^\circ$ - $20^\circ$ )." Over the next picture of the aircraft is the note, "Positive rate-Gear up." The next picture shows the aircraft level at 800 ft AGL and contains the accelerate instructions noted above.

EMERGENCY PROCEDURES

AA  
DC-10 OPERATING MANUAL

Section 4 Page 25  
4-10-79

TAKE-OFF ENGINE FAILURE  
FLAPS 15° OR LESS OR 22°

This procedure assumes indication of engine failure where the take-off is continued. Each take-off should be planned for the possibility of an engine failure. Normal take-off procedures ensure the ability to handle an engine failure successfully at any point.

If an engine failure occurs when making a Standard Thrust take-off. Standard Thrust on the remaining engines will produce the required take-off performance. If deemed necessary, the remaining engines may be advanced to Maximum Take-Off Thrust.

Speed . . . . . CLIMB OUT AT  $V_2$  UNTIL REACHING 800 FEET AFL  
OR OBSTACLE CLEARANCE ALTITUDE, WHICHEVER IS HIGHER.  
THEN LOWER NOSE AND ACCELERATE

At 0°/EXT Min Maneuver Speed.  
Flaps . . . . . UP

At  $V_2 + 50$  60 ■  
Slats . . . . . RETRACT  
If returning to land, slats may be left extended.

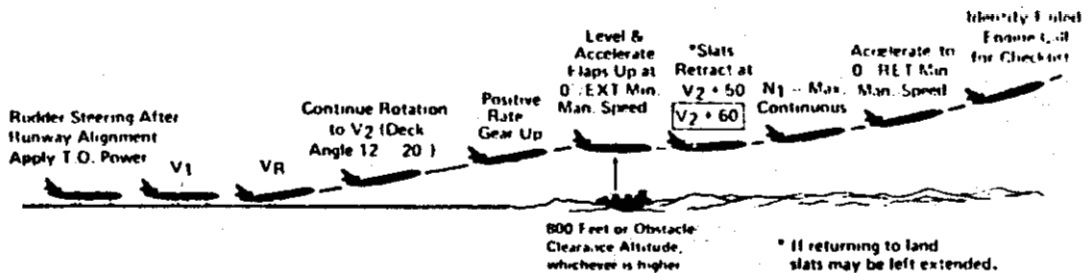

Figure 14. Diagram of AAL emergency procedure.

On July 23, 1979, American Airlines issued Operations Bulletin No. DC-10-73 which amended the procedure. The bulletin states, in part:

"The following climb speeds will be utilized to obstacle clearance altitude when an engine failure occurs after  $V_1$  on takeoff:

- If engine failure occurs after  $V_1$  but not above  $V_2$ , maintain  $V_2$  to obstacle clearance altitude.
- If engine failure occurs after  $V_2$ , maintain speed attained at time of failure but not above  $V_2 + 10$  to obstacle clearance altitude.

-If engine failure occurs at a speed higher than  $V_2 + 10$ , reduce speed to and maintain  $V_2 + 10$  to obstacle clearance altitude.

NOTE:

If the FD Take-Off mode is engaged at the time of engine failure the Pitch Command Bar (and the Fast/Slow Indicator) will command  $V_2$ . Therefore, if the failure occurs above  $V_2$ , disregard these indications and fly the speed called for in the above procedure."

1.17.10 Suspension and Hestoration of the DC-10 Type Certificate

On June 6, 1979, after a series of postaccident inspections disclosed damaged aft bulkheads in the wing to engine pylons, the Administrator of the FAA issued an Emergency Order of Suspension. The Order suspended the DC-10 series aircraft type certificate "until such time as it can be ascertained that the DC-10 aircraft meets the certification criteria of Part 25 of the FAR and is eligible for a Type Certificate."

On June 26, 1979, the FAA issued Special Federal Aviation Regulation 40 which prohibited the "operation of any Model DC-10 aircraft within the airspace of the United States."

On July 13, 1979, after a series of formal investigations, the Administrator found that the DC-10 met the requirements for issuance of a type certificate. Accordingly, the Emergency Order of Suspension was terminated. (See appendix G.)

## 2 ANALYSIS

The facts developed during the investigation disclosed that the initial event in the accident sequence was the structural separation of the No. 1 engine and pylon assembly from the aircraft's left wing. Witness accounts, flight data recorder parameters, and the distribution of the major structural elements of the aircraft following the accident provided indisputable evidence that the engine and pylon assembly separated either at or immediately after rotation and about the same time the aircraft became airborne. At that time, the flightcrew was committed to take off, and their decision not to attempt to discontinue takeoff was in accordance with prescribed procedure; and was logical and proper in light of information available to them.

The investigation and analysis were concentrated primarily in two major areas. First, the investigation sought to identify the structural failure which led to the engine-pylon separation and to determine its cause; second, the investigation attempted to determine the effects the structural failure had on the aircraft's performance and essential systems, and the operational difficulties which led to the loss of control. In addition, the investigation went beyond these primary areas and probed such areas as the vulnerability of the DC-10's design to maintenance damage, the adequacy of the DC-10's systems to cope with unique emergencies, the quality control exercised during DC-10 manufacturing and aircraft assembly, the adequacy of operator maintenance practices, the adequacy of industry communications of service and maintenance difficulties, the extent of FAA's surveillance of overall industry practices, and the adequacy of an accepted operational procedure.

### Pylon Structural Failure

The attachment points of the pylon were examined thoroughly. The fractures and deformations at the separation points in the forward bulkhead and thrust link were all characteristic of overload. The pylon separation began at the aft end in the upper flange of the aft bulkhead, which attached to other elements of the pylon. The upper flange, side flange, and the lower part of the aft bulkhead separated from the remainder of the aft bulkhead and were found on the runway with the engine and pylon structure. The upper portion of the bulkhead containing the spherical bearing remained attached to the wing. Except for the 3 inches of fatigue cracking at the corners of the upper flange, the remainder of the separations and deformations found on the aft bulkhead were a characteristic of overload.

The deformation and fractures at the aft bulkhead's inboard side flange, the thrust attachment, and forward bulkhead indicated that the final separation of the pylon began with a failure at the aft bulkhead which permitted the aft end of the pylon to move down and inboard before total separation. This separation sequence and direction of movement of the pylon before it broke free were consistent with the loads imposed on it during rotation when the combination of aerodynamic loads and thrust imposed a downward vertical tensile load on the bulkhead. The Safety Board could not determine exactly when the aft bulkhead failed, but the weight of the evidence indicated that it most probably failed during the takeoff roll and rotation.

The crescent-shaped deformation on the fracture surface, the shape of which exactly matched the radius of the bottom surface of the wing fitting clevis to which the bulkhead was mated, was strong evidence that the overstress crack in the flange was introduced during removal and installation of the pylon during maintenance. With the bulkhead to clevis attaching hardware in place, the upper surface of the flange was about 0.5 inch below the bottom of the clevis. In order for the clevis to have contacted the flange and deformed the fracture surface, the bolt and bushing through the clevis and the bulkhead's spherical bearing would have had to have been removed. Since this attaching hardware was still in place after the crash, the crescent-shaped deformation was not produced at ground impact and must have been produced when the pylon was installed or removed from the wing.

About 8 weeks before the accident, the No. 1 pylon and engine had been separated from the wing of the accident aircraft in order to replace the spherical bearings in compliance with McDonnell-Douglas' Service Bulletins 54-48 and 54-59. The four other American Airlines and two Continental Airlines aircraft, in which cracks were detected in the aft bulkhead's upper flange, had also been subjected to the same programmed maintenance during which the engine and pylon was removed. Further corroboration that the cracks had been produced during these maintenance operations was obtained when it was learned that Continental Airlines had, on two occasions before the accident, damaged the upper flange on the aft bulkhead as pylons were being removed or reinstalled. In these two instances, the damage was detected; the bulkheads were removed and repaired in accordance with a method approved by McDonnell-Douglas.

Therefore, the evidence indicated that the overstress cracks in the aft bulkhead's upper flange were being introduced during a maintenance operation used by American and Continental Airlines. Both operators had devised special programs to replace the forward and aft bulkhead's spherical bearings. The manufacturer's service bulletins recommended that the maintenance be performed during an engine removal and that the engine be removed from the pylon before the pylon was removed from the wing. Both American Airlines and Continental Airlines believed that it would be more practical to comply with the service bulletin when an aircraft was scheduled for major maintenance--maintenance which would not necessarily otherwise necessitate engine removal. Therefore, American and Continental devised a procedure which they believed to be more efficient than that recommended by McDonnell-Douglas--removal of the engine and pylon as a single unit. An engine stand and cradle were affixed to the engine and the entire weight of the engine and pylon, engine stand, and cradle was supported by a forklift positioned at the proper c.g. for the entire unit. The pylon to wing attaching hardware was removed, and the entire assembly was lowered for access to the spherical bearings. These were replaced and the entire unit was then raised and the attaching hardware reinstalled.

A close examination of these maintenance procedures disclosed numerous possibilities for the upper flange of the aft bulkhead, or more specifically the bolts attaching the spar web to this flange, to be brought into contact with the wing-mounted clevis and a fracture-producing load applied during or after removal of the attaching hardware in the aft bulkhead's fitting. Because of the close fit between the pylon to wing attachments and the minimal clearance between

the structural elements, maintenance personnel had **to** be extraordinarily cautious while they detached and attached the pylon. A minor mistake by the forklift operator while adjusting the load could easily damage the aft bulkhead and its upper flange. The flange could be damaged in an even more insidious manner; the forks could move imperceptibly as a result of either **an** internal or external pressure leak within the forklift's hydraulic system during pylon removal. The testimony of the mechanics who performed the maintenance on the accident aircraft confirmed that the procedure was difficult.

Two mechanics stated that they saw the upper lug of the aft bulkhead resting against the bolts attaching the wing-mounted clevis to the wing. To do so would have required a 0.6-inch relative movement between the aft bulkhead and the clevis, relative movement which could only have occurred after the upper flange was deformed. The tests performed by ~~both American Airlines and McDonnell-Douglas~~ following the accident confirmed that a deformation of this magnitude would produce an overload crack.

Except for the 10-inch fracture found on the accident aircraft, the longest maintenance-induced crack found on other upper flanges was 6 inches. Postaccident tests conducted by McDonnell-Douglas and American Airlines indicated that a 6- to 7-inch crack was the longest which could be introduced typically by loading and deforming the flange with a single dynamic impact or steady contact of the flange with the clevis as is believed to have occurred during maintenance.

The accident aircraft's pylon aft bulkhead assembly was the only one in which shims were installed between the bulkhead flange and the attaching spar caps and spar web. The Board believes that the installation of the shims may have had a stiffening effect on the flanges. Load applied to the flange through a spar web attachment-bolt by the wing clevis could be spread out through the shims and might have a tendency to produce a longer crack. The shims would also further reduce the clearance between the fastener heads and the lower surface of the wing clevis fitting. Thus, any upward movement of the aft bulkhead would produce a greater downward deflection on a shimmed upper flange than on an unshimmed upper flange. However, the shim might also add strength to the flange and a greater force might be required to crack the shimmed flange. The tests conducted after the accident failed to produce conclusive evidence that installation of shims caused a difference in the damage induced to the flange under similar loading conditions. Thus, the precise effect of the shims remains undetermined.

Tests conducted by McDonnell-Douglas however, did show that repeated load applications could produce a 10-inch crack in the upper flange. This could imply that the upper flange of the accident aircraft contacted the clevis two or more times during the conduct of the maintenance operation. Another possibility proposed by American Airlines which might explain the crack length in the accident aircraft is that the crack occurred in two steps; a crack on the order of 6 inches which occurred during maintenance extended to 10 inches upon the initial application of an abnormal operational load. It was theorized that, in the accident airplane, the installed clearance between the front surface of the aft bulkhead spherical bearing and the rear face of the wing clevis forward ear was less than the nominal minimum clearance of 0.080 in. American Airlines indicated that the aft bulkhead forward flange could have been subjected to a thrust load (tension) of sufficient magnitude to extend the crack during the application of engine takeoff power. To logically explain this possibility it was further theorized

that the tensile load would be transferred to other pylon members thus accounting for stoppage of the crack at the 10-inch length. The investigation could not determine the preaccident tolerances in the aircraft pylon structure; however, other aircraft were found during the postaccident inspections of the DC-10 fleet in which the clevis to bulkhead clearance was sufficiently small that a thrust load would have been imposed on the flange. Further credence is given this theory by the McDonnell-Douglas tests in which it was demonstrated that a flange with a 13-inch preexisting crack including the fatigue growth would not fail unless the vertical and horizontal operating load were augmented by a thrust load. However, the simulated preexisting damage in this test did not replicate the accident flange and thus the Safety Board did not view this test as conclusive evidence that a thrust load was applied to the bulkhead in the accident aircraft.

While the Safety Board considers the use of shims, the occurrence of repeated flange to clevis impacts, and the application of thrust loads because of improper tolerances as possible factors, other variables such as material grain flow, other material parameters, tolerances, and type of load application might also have resulted in the crack length found in the accident aircraft.

Based upon all the evidence, the Safety Board concludes that the structural separation of the pylon resulted from a complete failure of the forward flange of the aft bulkhead after its residual strength had been critically reduced by a maintenance-induced crack which had been lengthened by service loads.

#### Aircraft and Flightcrew Performance

The flightcrew of Flight 191 were certificated properly and were qualified for the flight. There was no evidence that their performance was affected by medical problems.

The No. 1 engine and pylon assembly separated after the flightcrew was committed to continuing the takeoff. Witnesses saw the pylon and engine assembly travel up and over the left wing after it separated, and the deformation of the pylon's forward bulkhead was consistent with their observations. The left wing's leading edge skin forward of the pylon's front bulkhead was found on the runway with the pylon structure. There was no evidence that the pylon and engine assembly struck any critical aerodynamic surfaces of the aircraft or any of the flight control surfaces.

Since the loss of thrust provided by the No. 1 engine and the asymmetric drag caused by the leading edge damage would not normally cause loss of control of the aircraft, the Safety Board sought to determine the effects the structural separation had on the aircraft's flight control systems, hydraulic systems, electrical systems, flight instrumentation and warning systems, and the effect, if any, that their disablement had on the pilot's ability to control the aircraft.

As the engine separated from the aircraft, those accessories which were driven by the engine were lost. This included the pumps which provided pressure to the aircraft's No. 1 hydraulic system, and the a.c. generator which provided electrical power to a.c. generator bus No. 1. During a routine emergency wherein the No. 1 engine ceases to operate, all of the Services provided by these accessories will remain operable, deriving their respective hydraulic pressure and electrical power from redundant sources driven by one or both of the remaining aircraft engines. However, when the engine separates from the aircraft, the hydraulic pressure and supply lines connecting the pumps with the system are severed, the hydraulic system loses all of its fluid, and thus, hydraulic pressure is not recoverable.

The separation of the engine and pylon also severed the electrical wire bundles inside the pylon. These included the main feeder circuits between the generator and the No. 1 a.c. generator bus. Although this would remove the normal source of power from the bus, the bus could have been powered by the a.c. tie bus, which is powered by generators on the other engines. The No. 1 a.c. generator bus is connected to the tie bus through a bus tie relay. Protective logic is provided in the aircraft's electrical system. If an electrical fault is detected on the generator bus, the protective logic will cause the bus tie relay to trip, which will open the circuit between the generator bus and the tie bus. This prevents a fault on one generator bus from affecting the aircraft's remaining electrical services. In this accident, the loss of the CVR and certain parameters on the FDK provided evidence that the No. 1 bus tie relay opened when the engine separated, probably as a result of transient short circuits during the separation. The Safety Board concludes that the electrical system's protective circuitry functioned as it was intended and power to the No. 1 generator bus and the services powered by that bus, including d.c. bus No. 1 and left emergency a.c. and d.c. buses, were lost. None of these buses was restored for the remainder of the flight.

The flightcrew might have been able to restore the No. 1 generator bus and all of its services by activating the guarded bus tie relay switch on the electrical and generator reset panel. This action would have been effective only if the bus fault sensed during the separation was temporary. The evidence indicated that the left emergency a.c. and d.c. buses, and the No. 1 d.c. bus could have been restored separately by the activation of the emergency power switch and the No. 1 d.c. tie switch in the cockpit. There was no evidence to indicate that this was done.

The Safety Board believes that the flightcrew probably did not try to restore the lost electrical power, either because of the nature of the overall emergency involving other systems, which they probably perceived to be more critical than the electrical problems, or because the time interval did not permit them to evaluate and respond to the indicated electrical emergency. The Safety Board does not criticize the crew's inaction in this regard; however, since electrical power was not restored, the captain's flight director instrument, several sets of engine instruments and, most importantly, the stall warning and slat disagree warning light systems remained inoperative.



Because of the designed redundancy in the aircraft's hydraulic and electrical systems, the losses of those systems powered by the No. 1 engine should not have affected the crew's ability to control the aircraft. However, as the pylon separated from the aircraft, the forward bulkhead contacted end severed four other hydraulic lines and two cables which were routed through the wing leading edge forward of the bulkhead. These hydraulic lines were the operating lines from the leading edge slat control valve, which was located inboard of the pylon, and the actuating cylinders, which extend and retract the outboard leading edge slats. Two of the lines were connected to the No. 1 hydraulic system and two were connected to the No. 3 system, thus providing the redundancy to cope with a single hydraulic system failure. The cables which were severed provided feedback of the leading edge slat position so that the control valve would be nulled when slat position agreed with position commanded by the cockpit control.

The severing of the hydraulic lines in the leading edge of the left wing could have resulted in the eventual loss of No. 3 hydraulic system because of fluid depletion. However, even at the most rapid rate of leakage possible, the system would have operated throughout the flight. The extended No. 3 spoiler panel on the right wing, which was operated by the No. 3 hydraulic system, confirmed that this hydraulic system was operating. Since two of the three hydraulic systems were operative, the Safety Board concludes that, except for the No. 2 and No. 4 spoiler panels on both wings which were powered by the No. 1 hydraulic systems, all flight controls were operating. Therefore, except for the significant effect that the severing of the No. 3 hydraulic system's lines had on the left leading edge slat system, the fluid leak did not play a role in the accident.

During takeoff, as with any normal takeoff, the leading edge slats were extended to provide increased aerodynamic lift on the wings. When the slats are extended and the control valve is nulled, hydraulic fluid is trapped in the actuating cylinder and operating lines. The incompressibility of this fluid reacts against any external air loads and holds the slats extended. This is the only lock provided by the design. Thus, when the lines were severed and the trapped hydraulic fluid was lost, air loads forced the left outboard slats to retract. While other failures were not critical, the uncommanded movement of these leading edge slats had a profound effect on the aerodynamic performance and controllability of the aircraft. With the left outboard slats retracted and all others extended, the lift of the left wing was reduced and the airspeed at which that wing would stall was increased. The simulator tests showed that even with the loss of the No. 2 and No. 4 spoilers, sufficient lateral control was available from the ailerons and other spoilers to offset the asymmetric lift caused by left slat retraction at airspeeds above that at which the wing would stall. However, the stall speed for the left wing increased to 15Y KIAS.

The evidence was conclusive that the aircraft was being flown in accordance with the carrier's prescribed engine failure procedures. The consistent 14° pitch attitude indicated that the flight director command bars were being used for pitch attitude guidance and, since the captain's flight director was inoperative, confirmed the fact that the first officer was flying the aircraft. Since the wing and engine cannot be seen from the cockpit and the slat position indicating system was inoperative, there would have been no indication to the flightcrew of the slat retraction and its subsequent performance penalty. Therefore, the first officer continued to comply with carrier procedures and maintained the

commanded pitch attitude; the flight director command bars dictated pitch attitudes which decelerated the aircraft toward  $V_2$ , and at  $V_2 + 6$ , 159 KIAS, the roll to the left began.

The aircraft configuration was such that there was little or no warning of the stall onset. The inboard slats were extended, and therefore, the flow separation from the stall would be limited to the outboard segment of the left wing and would not be felt by the left horizontal stabilizer. There would be little or no buffet. The DFDR also indicated that there was some turbulence, which could have masked any aerodynamic buffeting. Since the roll to the left began at  $V_2 + 6$  and since the pilots were aware that  $V_2$  was well above the aircraft's stall speed, they probably did not suspect that the roll to the left indicated a stall. In fact, the roll probably confused them, especially since the stickshaker had not activated.

The roll to the left was followed by a rapid change of heading, indicating that the aircraft had begun to yaw to the left. The left yaw -- which began at a 4° left wing down roll and at 159 KIAS--continued until impact. The abruptness of the roll and yaw indicated that lateral and directional control was lost almost simultaneous with the onset of the stall on the outboard section of the left wing.

The simulator tests showed that the aircraft could have been flown successfully at speeds above 159 KIAS, or if the roll onset was recognized as a stall, the nose could have been lowered, and the aircraft accelerated out of the stall regime. However, the stall warning system, which provided a warning based on the 159 KIAS stall speed, was functioning on the successful simulator flights. Although several pilots were able to recover control of the aircraft after the roll began, these pilots were all aware of the circumstances of the accident. All participating pilots agreed that based upon the accident circumstances and the lack of available warning systems, it was not reasonable to expect the pilots of Flight 191 either to have recognized the beginning of the roll as a stall or to recover from the roll. The Safety Board concurs.

In addition, the simulator tests showed that the aircraft could have been landed safely in its accident configuration using then current American Airlines procedures. The simulator tests also disclosed that the aircraft could have been landed with an Asymmetric leading edge slat configuration. The speed margins during the final positions of the landing approach are also very small; however, the landing situation is considered less critical since additional thrust is readily available as required to either adjust the flightpath or accelerate the aircraft. In addition, service experience has shown that loss of slats on one wing during the approach presents no significant control problems.

The pilot's adherence to the airspeed schedules contained in the company's engine-out emergency procedure resulted in the aircraft's entering the stall speed regime of night. Had the pilot maintained excess airspeed, or even  $V_2 + 10$ , the accident may not have occurred. Since the airspeed schedules contained in American Airlines' emergency procedures at the time of the accident were identical to those currently contained in the emergency procedures of other air carriers, the Safety Board believes that speed schedules for engine-out climb profiles should be examined to insure that they afford the maximum possible protection.

In summary, the loss of control of the aircraft was caused by the combination of three events: the retraction of the left wing's outboard leading edge slats; the loss of the slat disagreement warning system; and the loss of the stall warning system -- all resulting from the separation of the engine pylon assembly. Each by itself would not have caused a qualified flightcrew to lose control of its aircraft, but together during a critical portion of night, they created a situation which afforded the flightcrew an inadequate opportunity to recognize and prevent the ensuing stall of the aircraft.

#### DC-10 Design and Certification

■ The pylon design, and in particular the aft bulkhead and its upper flange, satisfied the fail-safe requirements of the 1965 Federal Aviation Regulations. The stress analysis of the pylon structure showed that the stress level in the upper flange of the aft bulkhead was well below the fatigue damage level and the material was not considered to be vulnerable to stress corrosion. Therefore, since it was not necessary to apply fail-safe criteria to the flange, the design did not provide an alternate path for the transmittal of loads in the event the flange failed. Although the flight tests conducted after the accident disclosed that additional thrust loads were being imposed on the aft bulkhead which were not accounted for in the original certification analysis, the stress levels were still below the fatigue-damage level. In addition, postaccident tests and analyses of alternate load paths for other pylon structural members showed that, even with a failed thrust link, the bulkheads could carry the takeoff thrust load. Furthermore, the postaccident inspections of the DC-10's did not disclose any evidence of fatigue damage on any of the bulkheads within the fleet. Therefore, the Safety Board finds that the original certification's fatigue-damage assessment of fatigue damage was in conformance with the existing requirements.

The Damage-Tolerance concept embodied in the December 1, 1978, amendment to 14 CFR 25.571 levies different requirements on the certification of structural design. While the regulations in effect prior to the adoption of this amendment considered susceptibility of undamaged structure to fatigue, this new concept requires that an evaluation of the strength, detail design, and fabrication must show that catastrophic failure due to fatigue, corrosion, or accidental damage will be avoided throughout the operational life of the aircraft. The evaluation must include a determination of the probable locations and modes of damage due to fatigue, corrosion, or accidental damage. If a part is determined to be susceptible to these types of damage, its operational life must be established by analysis and supporting tests. The operational life must be consistent with the onset of damage and its subsequent growth during testing. The results of these tests and analyses are used to establish inspection areas and frequencies to monitor the structural integrity of the part.

Had the requirement for accidental damage evaluation been in effect when the DC-10 was designed, one might expect that such consideration would have been given to accidental damage to the upper flange of the pylon aft bulkhead. However, this would still have depended upon the interpretation of the type of accidental damage required to be considered. The manufacturer contends that accidental damage should be limited to damage which can be inflicted during routine aircraft maintenance or servicing, such as contact at galley and cargo

doors or dropping of tools in areas of frequent maintenance. Based on this interpretation, the accidental contact between the pylon aft bulkhead and the wing-mounted clevis probably would not have been considered since it did not constitute routine maintenance. And, even had this accidental contact been considered, the design may not have been different; however, more stringent inspection requirements might have been imposed, particularly following maintenance. Following the accident, the FAA required McDonnell-Douglas to conduct a damage-tolerance assessment of the pylon structure in accordance with the new regulation. When the program was conducted it was presumed that a crack in the bulkhead flange could be detected visually before it was 3 inches long and that the residual strength of the damaged element would far exceed the operational load requirements. Based on these criteria, the analysis and tests showed that the design meets the current damage-tolerance requirement.

Although the design of the pylon complied with the strength requirements of the regulations, the Safety Board believes that neither the designers nor the FAA certification review team adequately considered the vulnerability of the structure to damage during maintenance. In several places, clearances were unnecessarily small and made maintenance difficult to perform. Historically, pylons have had to be lowered and replaced for many reasons, such as ground accidents, fatigue, and corrosion. In fact, parts of the pylon structure are either on a sampling inspection or 100-percent inspection schedule. Under these circumstances, McDonnell-Douglas should have foreseen that pylons would be removed, and therefore, the mating parts of the aft bulkhead should have been designed to eliminate, or at least minimize, vulnerability to damage during maintenance. Whenever major components are made up of parts that can be removed, the design must protect each part from damage during removal or reinstallation. Either the parts should be made strong enough to withstand inadvertent contact, or clearances should be provided that will not allow contact. The pylon aft bulkhead could have been designed so that the upper part of the lug would bottom on the base of the wing-mounted clevis, before the upper spar web and aft bulkhead flange assembly contacted the clevis ear. On the actual design there is only .080-inch clearance between the bolt heads on the flange assembly and the clevis with the pylon installed. With adverse tolerances, this clearance of the fitting can be reduced to less than .030 inch. The evidence, provided by a dimensional analysis, which included the thickness of the shims, showed that an interference fit of about .030 inch could have existed. Following the accident, interference was also found in some other aircraft in which shims were installed.

In order to reinstall a pylon with an interference fit between the aft bulkhead flange assembly and the wing clevis, the flange assembly would have to be brought into contact with the wing clevis and the flange would have to be loaded and deflected enough to allow the bushing and bolt to be inserted through the clevis and spherical joint. Although tests showed that the load required to create this deflection would not fracture the flange, the maintenance operation, regardless of the procedures used, would be difficult to perform and would be particularly vulnerable to damage-producing errors. Thus, the Safety Board concludes that the basic design of the aft attachment of the pylon to the wing was unnecessarily vulnerable to maintenance damage.

The Safety Board is also concerned that the designs of the flight control, hydraulic, and electrical systems in the DC-10 aircraft were such that all

were affected by the pylon separation to the extent that the crew was unable to ascertain the measures needed to maintain control of the aircraft.

The airworthiness regulations in effect when the DC-10 was certificated were **augmented** by a Special Condition, the provisions of which had to be met before the aircraft's fully powered control system would **be** certificated. The Special Condition required that the aircraft **be** capable of continued flight and **of** being landed safely after failure of the flight control system, including lift devices. These capabilities must be demonstrated by analysis **or** tests, or both. However, the Special Condition, **as** it applied to the slat control system, was consistent with the basic airworthiness regulations in effect at the time. The basic airworthiness regulations specified requirements for wing flap asymmetry only and did not include specific consideration of other lift devices. Because the leading edge slat design did not contain any novel or unusual features, it was certificated under the basic regulation. The flap control requirements for symmetry and synchronization were applied to and satisfied by the slat system design. Since a malfunction of the slat actuating system could disrupt the operation of an outboard slat segment, a fault analysis was conducted to explore the probability and effects of both an uncommanded movement of the outboard slats and the **failure of the** outboard slats **to** respond to a commanded movement. The fault analysis concluded that the aircraft could be flown safely with this asymmetry.

Other aircraft designs **include** positive mechanical locking devices to prevent movement **of slats** by external loads following a **primary** failure. The DC-10 design did not include such **a feature** nor was it **deemed necessary**, since compliance with the regulations was based upon analysis of those failure modes which could result in asymmetrical positioning of the leading edge devices **and a demonstration** that sufficient lateral control was available to compensate for the asymmetrical conditions throughout the aircraft's flight envelope. The flight tests conducted to evaluate the controllability **of** the aircraft were limited to a minimum airspeed compatible with stall-warning activation predicated upon the slat-retracted configuration.

The **takeoff** regime at lower airspeeds **was** not examined in flight. However, analysis of the takeoff regime showed that, with all engines operating, the aircraft would be **accelerated** to and maintain a positive stall margin throughout the flight. The analysis also showed that if a loss of engine thrust and slat retraction were to **occur** during takeoff, the aircraft's capability to accelerate to and maintain a positive stall margin was compromised. Further consideration of this hazardous combination was limited to a mathematical **probability** projection, which showed that the combination was extremely improbable. Thus, the design was **accepted** as complying with the requirements. **If** the structural loss of a pylon had been included in the probability projection, the vulnerability of the hydraulic lines and position feedback cables may have influenced adversely the probability projection.

**Also**, the influence on aircraft **control** of the combined failure of the hydraulic and electrical systems was not considered. When aircraft controllability was first evaluated based on asymmetric leading edge devices, it was presumed that other flight controls would be operable and that slat disagree and stall warning devices would be functioning. Flight 191 had accelerated **to** an airspeed at which an ample stall margin existed. Postaccident simulator tests showed that, if the

airspeed had been maintained, control could have been retained regardless of the multiple failures of the slat control, or loss of the engine and Nos. 1 and 3 hydraulic systems. On this basis alone, the Safety Board would view the design of the leading edge slat system as satisfactory. However, the additional loss of those systems designed to alert the pilot to the need to maintain airspeed was most critical. The stall warning system lacked redundancy; there was only one stickshaker motor; and the left and right stall warning computers did not receive crossover information from the applicable slat position sensors on opposite sides of the aircraft. The accident aircraft's stall warning system failed to operate because d.c. power was not available to the stickshaker motor. Even had dc. power been available to the stickshaker motor, the system would not have provided a warning based on the slats retracted stall speed schedule, because the computer receiving position information from the left outboard slat was inoperative due to the loss of power on the No. 1 generator bus. Had power been restored to that bus, the system would have provided a warning based on the slat retracted stall speed. However, in view of the critical nature of the stall warning system, additional redundancy should have been provided in the design.

In summary, the certification of the DC-10 was carried out in accordance with the rules in effect at the time. The premises applied to satisfy the rules were in accordance with then accepted engineering and aeronautical knowledge and standards. However, in retrospect, the regulations may have been inadequate in that they did not require the manufacturer to account for multiple malfunctions resulting from a single failure, even though that failure was considered to be extremely improbable. McDonnell-Douglas considered the structural failure of the pylon and engine to be of the same magnitude as a structural failure of a horizontal stabilizer or a wing. It was an unacceptable occurrence, and therefore, like the wing and horizontal stabilizer, the pylon structure was designed to meet and exceed the foreseeable loads for the life of the aircraft. Therefore, just as it did not analyze the effect the loss of a wing on horizontal stabilizer would have on the aircraft's systems, McDonnell-Douglas did not perform an analysis based on the loss of the pylon, and engine.

Logic supports the decision not to analyze the loss of the wing and horizontal stabilizer. With the loss of either of those structures, further flight is aerodynamically impossible and the subsequent effect of the loss on the aircraft's systems is academic. However, similar logic fails to support the decision not to analyze the structural failure and loss of the engine and pylon, since the aircraft would be aerodynamically capable of continued flight. The possibility of pylon failure, while remote, was not impossible. Pylons had failed. Therefore, fault analyses should have been conducted to consider the possible trajectories of the failed pylon, the possibilities of damage to aircraft structure, and the effects on the pilot's ability to maintain controlled flight. Since the capability of continued flight was highly probable, the fault analysis might have indicated additional steps or methods which could have been taken to protect those systems essential to continued flight.

Therefore, the Safety Board concludes that the design and interrelationship of the essential systems as they were affected by the structural loss of the pylon contributed to this accident.

### Manufacturing and Quality Control

The Safety Board did not determine whether the installation of the shims in the pylon aft bulkhead and spar web assembly was a factor in this accident. However, the inclusion of these shims on certain aircraft raised concerns regarding the adequacy of manufacturing quality control. These concerns were heightened when several pylons were found to have failed, loose, or missing fasteners, including the significantly damaged pylon on the United Airlines DC-10, N1827U. These too were attributable to production deficiencies at the McDonnell-Douglas facilities where the pylons were assembled.

Beginning with fuselage No. 15 and ending with fuselage No. 36, there were 23 pylons which required the insertion of 10-inch-long, .050-inch-thick shims. Within these 21 fuselages, there was interference between the bottom of the clevis and the fastener heads on 7 pylons.

A Rejection and Disposition Item had been issued for the shim on the accident aircraft; however, the evidence was inconclusive as to whether the proper procedures were followed in issuing the authorization. The authorization was signed by a liaison engineer, indicating that a stress analysis had been made on the effects of the shim. However, there was no evidence that a dimensional analysis had been conducted to determine whether the insertion of the shims would adversely affect clearance during assembly of the pylon to the wing, a clearance which could affect the loads imposed on primary structural elements. The clearance problem on the upper flange was resolved by repositioning locator pins on the tooling jigs; however, before this solution was found, 21 fuselages had passed through the line and 23 pylons had required the shim. The Safety Board believes that proper quality control procedures would have brought about an earlier resolution of this problem.

In addition, despite inspection and quality control procedures, 31 fuselages left the assembly line with defective pylon fasteners. The number of defective fasteners ranged from a minimum of 2 to a maximum of 26, found on the United Airlines DC-10.

In summary, the evidence showed that there were deficiencies in the pylon assembly procedures at McDonnell-Douglas and that the quality-control procedures in effect did not detect and effect a timely correction of these deficiencies. While these were not causal to this accident, the Safety Board believes that they illustrate deficiencies of the type which could lead to accidents.

### Maintenance Programs

Although the Safety Board believes that the design of the pylon structure was less than optimum with regard to maintainability, the evidence is conclusive that many pylons were removed from the wing and reinstalled without imposing damage to the structure. There is no doubt, however, that this maintenance operation requires caution and extreme precision because of the minimal clearances at the pylon-to-wing attachment points and the danger of inadvertent impact of the structure.

McDonnell-Douglas was apparently aware of the precision which would be required, and as a result it specified in its original maintenance procedures and subsequent service bulletins that the engine be separated from the pylon before the pylon is removed from the wing. While removal of the engine would not completely eliminate the possibility of imposing damage to the pylon structure, the likelihood would certainly be much less than that which existed when handling the pylon and engine as single unit. The pylon assembly without the engine weighs about 1,865 lbs and the c.g. is located approximately 3 ft forward of the forward bulkhead attachment points. The pylon and engine together weigh about 13,477 lbs. and the c.g. is located about 9 ft forward of the forward bulkhead attachment points. With the engine removed, the pylon can be supported relatively close to the pylon-to-wing attachment points where precise relative motion between the pylon and wing structure can be closely observed and controlled. Thus, McDonnell-Douglas did not encourage removing the engine and pylon assembly as a single unit because of the risk involved in remating the combined assembly to the wing attachment points. The Safety Board, therefore, is concerned with the manner in which the procedures used to comply with Service Bulletins 54-48 and 54-59 were evaluated, established, and carried out.

American Airlines is a designated alteration station, as are the other major carriers that conduct heavy maintenance programs. Pursuant to that designation and the applicable regulations, carriers are authorized to conduct major maintenance in accordance with the maintenance and inspection program established by the FAA's Maintenance Review Board when the aircraft was introduced into service. Carriers are also authorized to conduct alterations and repairs in accordance with the procedures set forth in its maintenance manuals or established by its engineering departments. The FAA, through its principal maintenance inspectors, is responsible for surveillance of carriers' maintenance programs. However, this surveillance is broadly directed toward insuring that the carriers comply with the established maintenance and inspection program and that their maintenance programs, including administration, general practices, and personnel qualifications, are consistent with practices acceptable to the Administrator. The FAA can review the carriers' maintenance manual, but its formal approval is not required. Carriers are permitted to develop their own step-by-step maintenance procedures for a specific task without obtaining the approval of either the manufacturer of the aircraft or the FAA. It is not unusual for a carrier to develop procedures which deviate from those specified by the manufacturer if its engineering and maintenance personnel believe that the task can be accomplished more efficiently by using an alternate method.

Thus, in what they perceived to be in the interest of efficiency, safety, and economy, three major carriers developed procedures to comply with the changes required in Service Bulletins 54-48 and 54-59 by removing the engine and pylon assembly as a single unit. One carrier apparently developed an alternate procedure which was used without incident. However, both American Airlines and Continental Airlines employed a procedure which damaged a critical structural member of the aircraft. The procedure, developed by American Airlines and issued under ECO R-2693, was within American Airlines' authority, and approval or review was neither sought nor required from the manufacturer or the FAA.



The evidence indicated that American Airlines' engineering and maintenance personnel implemented the procedure without a thorough evaluation to insure that it could be conducted without difficulty and without the risk of damaging the pylon structure. The Safety Board believes that a close examination of the procedure might have disclosed difficulties that would have concerned the engineering staff. In order to remove the load from the forward and aft bulkheads spherical joints simultaneously, the lifting forks had to be placed precisely to insure that the load distribution on each fork was such that the resultant forklift load was exactly beneath the c.g. of the engine and pylon assembly. To accomplish this, the forklift operator had to control the horizontal, vertical, and tilt movements with extreme precision. The failure of the ECO to emphasize the precision this operation required indicates that engineering personnel did not consider either the degree of difficulty involved or the consequences of placing the lift improperly. Forklift operators apparently did not receive instruction on the necessity for precision, and the maintenance and engineering staff apparently did not conduct an adequate evaluation of the forklift to ascertain that it was capable of providing the required precision.

The evidence showed that during the actual maintenance, the forklift operator used the supported weight gauge to adjust the forklift; however, the adjustment was made in a trial-and-error fashion until the attaching hardware was removed from the forward bulkhead. If the load applied by the forklift with respect to the c.g. of the assembly was not balanced, a load would be applied at the aft bulkhead attachment joint. Thus, after the maintenance personnel removed the forward bulkhead and thrust link attachments, they would not be able to remove the loaded bolt and bushing from the aft bulkhead fitting until the forklift was repositioned. More precision was required to reposition the forklift because of the 15-ft distance from the forklift to the aft bulkhead. If the bolt and bushing were forced out of the bulkhead attachment while under load, the aft end of the pylon could move and the upper spar web to aft bulkhead flange attachment bolts could strike the forward lug of the wing clevis and apply a bending load to the flange. Whether the force applied through the contacting surfaces would be enough to damage the pylon structure depended upon the alignment precision of the forklift operator.

Maintenance personnel testified that it was difficult to adhere to the removal sequence of the attaching hardware that was specified in the ECO. The Safety Board believes that the difficulty encountered in repositioning the forklift to remove the load at the aft bulkhead was the basis for such an assessment. As a result, maintenance personnel altered the sequence of hardware removal, and removed the attachments at the aft bulkhead before those of the forward bulkhead. Using this procedure, the forklift was positioned to remove the load at the aft bulkhead first. Although this still required extreme precision, the pivot action at the attached forward bulkhead reduced the lever arm over which minor misalignments of the forklift would act. However, while easing the task of removing the aft bulkhead fitting, the change to this sequence greatly increased the risk of damage to the pylon structure.

After the bolt and bushing were removed from the aft bulkhead attachment joint, the forward bulkhead would continue to act as a pivot. Thus, any inadvertent ... inadvertent vertical movement of the forklift would result in a vertical movement at the pylon's aft bulkhead. If the lifting forks were lowered, the spar web attachment at the aft bulkhead flange would be brought into contact with the forward lug of the wing clevis; and if the forks were lowered further, the supported weight of the combined assembly would be transferred from the forklift to the aft bulkhead to wing clevis contact. As the load is transferred, it will increase and can eventually reach the limit wherein the aft bulkhead is reacting the total moment about the forward bulkhead created by the weight of the combined assembly and the 9 ft distance to the c.g. This could impose a load of over 20,000 lbs. on the aft bulkhead (which is about 6 ft from the forward bulkhead). The tests showed that the flange would fracture with a load application of less than 8,000 lbs. 2/

Had a proper evaluation of this procedure been conducted, it should have been apparent that there are two probable reasons which would cause lifting forks to lower: First, it was almost certain that the forklift operator would have to readjust the forklift to relieve the load in the forward bulkhead spherical joints before their removal. In doing so, it was conceivable that he would operate both elevation and tilt controls in a manner which would momentarily lower the lifting forks. Second, any removal of power from the forklift when combined with external or internal leakage within the forklift hydraulic system would result in a slow descent of the lifting forks.

The testimony at the public hearing disclosed that the forklift had to be repositioned after the attachment hardware of the aft bulkhead was removed during a pylon removal, and the evidence indicated that this occurred on the accident aircraft. The testimony also indicated that the forklift was not powered for a period of time because it ran out of fuel. The postaccident forklift tests showed that under these conditions, leakage would allow a drift down of 1 inch in 30 min. The postaccident flange loading tests showed that a movement of 0.4 inch or less at the c.g. would produce a 7-inch fracture of the flange.

The evidence also showed that, in two instances at Continental Airlines, the sound caused by the flange fracturing was heard by maintenance personnel. The fact that it was not heard by maintenance personnel in the other cases can probably be attributed to several factors: the surrounding noise level in the work area, the locations of the maintenance personnel when the flange broke; the sound produced by the fracture may not have been as loud; or a combination of all these factors. The Safety Board, therefore, concludes that there were several possibilities wherein the aft bulkhead flange could have been damaged, and that such damage could have occurred without being detected by maintenance personnel working in the vicinity of the pylon. The Safety Board also concludes that these hazards might have been detected had a proper evaluation been conducted.

7/ With the engine removed, the maximum load which can be imposed on the aft bulkhead because of the moment about the forward bulkhead is about 900 lbs.

There was no evidence that the American Airlines maintenance personnel informed either the engineering or quality control department about the difficulties they encountered using the ECO sequence or that the sequence was changed. Had they done so, it was possible that the cognizant engineers would have examined more closely the entire operation from the standpoint of damage risk. However, the testimony at the public hearing indicated that without specific instructions to the contrary, sequential adherence to the times in the ECO was not mandatory. Also, there was no evidence to show that either engineering or quality control personnel routinely examine maintenance procedures in a step-by-step fashion to determine whether such procedures were particularly damage-inducing.

The Safety Board believes that other shortcomings were evident in the ECO and in the manner in which it was implemented on the accident aircraft. The ECO did not specify in the requirement for inspection that the pylon structure be inspected either before or after it was reinstalled on the wing. The evidence showed that the pylon upper spar web to the mating structure attachment was inspected and the new sealant was installed after the assembly was lowered from the wing. However, the Safety Board could not determine the extent to which the aft bulkhead flange was examined. Furthermore, the ECO did not require that quality control personnel inspect either the pylon structure or the pylon to wing attachment hardware after the pylon was reinstalled to the wing. While this omission does not appear to be a factor in this accident, it does present the potential for an accident-producing error to escape detection.

The Safety Board, therefore, concludes that there were other deficiencies within the American Airlines maintenance program, some of which contributed to this accident. Among these was the failure of engineering department to ascertain the damage-inducing potential of a procedure which deviated from the manufacturer's recommended procedure, their failure to adequately evaluate the performance and condition of the forklift to assure its capability for the task, the absence of communications between maintenance personnel and engineers regarding difficulties encountered and the procedural changes which were required in the performance of the pylon maintenance, and the failure to establish an adequate inspection program to detect maintenance-imposed damage. Although the Safety Board directed its investigation to American Airlines, the Safety Board is concerned that these shortcomings were not unique to that carrier. Since two of Continental Airlines DC-10's were found to have been flying with damaged bulkheads, similar shortcomings were also present in its maintenance program.

The Safety Board is also concerned about broader issues of maintenance and inspection as they relate to the program established by the DC-10 Maintenance Review Board when the aircraft was initially introduced into service. While the inspection program appears to be monitoring the on-condition maintenance process adequately, the postaccident investigations of the DC-10 fleet disclosed areas where shortcomings within the inspection program may exist.

Much of the DC-10's pylon structure was subject to a sampling inspection program. Consequently, damage related to manufacturing deficiencies on certain aircraft would only have been detected if one of those aircraft had been among the population of the inspected sample. Therefore, the failures of the

B

fasteners and the cracks on the upper spar web of United Airlines DC-10 N1827U would not have been detected had it not been for the inspections required as a result of the accident. The area in which the damage was located was not a 100-percent inspection area. While other items on the pylon near the damaged area were under the 100-percent inspection program and the inspector should, when the area was opened for the required inspection, inspect all areas that are visible, the probability of finding the damage would be limited by the area open to his vision and the manner in which he conducted the inspection. Despite the requirements for the 100-percent inspections on nearby pylon structure, the probability of detecting damage in an adjacent area was not good, as evidenced by the 31 aircraft with loose, failed, or missing fasteners discovered during postaccident inspections. The facts indicate that inspection requirements should be established that will allow for the detection of these types of discrepancies.

The Safety Board is also concerned that, as indicated in this accident, significant structural items can be damaged during major maintenance without the knowledge of the personnel performing the task. The postaccident investigation disclosed that six DC-10's were returned to service with a cracked flange in the pylon aft bulkhead, one of which contained fatigue cracks at the ends of the fracture. The evidence points out the necessity for establishing inspection programs that will insure that significant structural items damaged in this manner can be detected before they are returned to service and to reassure, by a later inspection, that the repaired structure and the structure which has been exposed to major maintenance has not been damaged or flawed.

In summary, the Safety Board believes that the criteria used by the Maintenance Review Board to establish inspection requirements should be reviewed to determine their adequacy for insuring detection of damage to structurally significant parts which can result from faults introduced during manufacturing, assembly, and maintenance operations.

#### Industry Communications Regarding Maintenance Difficulties

The Safety Board is particularly concerned that because of the limitations of the current reporting system the FAA and key engineering and maintenance personnel at American Airlines were not aware that Continental Airlines had damaged two aft bulkhead flanges on two of its DC-10's until after the accident. In December 1978, after it discovered the first damaged bulkhead, Continental apparently conducted a cursory investigation and determined that the damage resulted from a maintenance error. A repair was designed for the bulkhead and was submitted to McDonnell-Douglas for stress analysis approval. The repair was approved and performed, and the aircraft returned to service.

On January 5, 1979, Operational Occurrence Report So. 10-7901 was published by McDonnell-Douglas. The publication contained descriptions of several DC-10 Occurrences involving various aircraft systems, personnel injury, and the damage inflicted on the Continental Airlines DC-10. The report described the damage to the upper flange of the Continental aircraft and indicated that it occurred during maintenance procedures used at the time it was damaged. However, the way in which the damage was inflicted was not mentioned. The manufacturer had no authority to investigate air carrier maintenance practices and, therefore, accepted the carrier's evaluation of how the flange was damaged.

Since the damage was inflicted during maintenance, 14 CFR 21.3 relieved McDonnell-Douglas of any responsibility to report the mishap to the FAA. Although American Airlines was on the distribution list for Operational Occurrence Reports, testimony disclosed that the maintenance and engineering personnel responsible for the pylon maintenance were not aware of the report.

Continental Airlines discovered the damage to the second bulkhead in February 1979. Again the carrier evaluation indicated that the cause of the damage was related to personnel error, and that there was apparently no extensive effort to evaluate the engine-pylon assembly removal and reinstallation procedures. The bulkhead was also repaired using the procedure previously approved by McDonnell-Douglas.

The carrier did not report the repairs that were made to the two bulkheads to return them to service, and there was no regulatory requirement to do so. What constitutes a major repair may be subject to interpretation, but what is to be reported is not. The bulkheads were not altered; they were repaired. Even had the repairs been classified by the carrier as major, 14 CFR 121.707(b) only requires that a report be prepared and kept available for inspection by a representative of the FAA. Second, the regulation does not indicate that the contents of the required report include a description of the manner in which the damage was inflicted. The regulation and the evidence indicated that the purpose of the reports was to permit the FAA to evaluate the end-product to insure that the basic design of the repaired or altered part had not been changed.

The Mechanical Reliability Reporting criteria of 14 CFR 121.703 requires the certificate holder to report "the occurrence or detection of each failure, malfunction, or defect concerning..." and then lists 16 criteria to which these apply. The FAA and apparently the aviation industry have traditionally interpreted 121.703 to apply to only service-related problems, which would therefore exclude reporting of the flange damage caused by maintenance. In view of this interpretation, the Board concludes that there is a serious deficiency in the reporting requirements which should be corrected.

Therefore, the Safety Board concludes that neither the air carrier nor the manufacturer interpreted the regulation to require further investigation of the damages or to report the damage to the FAA. However, the Safety Board views the omission of such requirements as a serious deficiency in the regulations.

The Safety Board also believes that regardless of the regulation, Continental Airlines had the opportunity and should have conducted a thorough investigation into the damage risk involved in the procedure being used to accomplish the pylon maintenance, particularly after it was known that two bulkheads had been damaged. Certainly, the possibility that similar damage could have occurred on other aircraft without detection and the possibility that other carriers using similar maintenance procedures could encounter the same problem should have been considered. Had a more thorough investigation been conducted, the incident might have been given more emphasis in the report to the other carriers. Action then might have been taken to revise the maintenance procedure and to inspect those aircraft which had been exposed to the potential damage.

McDonnell-Douglas did not investigate Continental Airlines' maintenance procedures and accepted its finding that the damage was due to maintenance error. However, 2 months later McDonnell-Douglas received the report that a second bulkhead was damaged, that the location and type of damage was almost identical to the damage inflicted on the first bulkhead, and that the damage was again due to maintenance error. McDonnell-Douglas then had the opportunity to question whether maintenance error was the result of a procedural problem rather than accepting personnel error as the cause. They should have investigated the procedure and perhaps discovered the flaws within the procedure. However, they accepted the company's evaluation of cause and did not pursue the matter further.

The Safety Board, therefore, believes that the regulatory reporting structure had and still has a serious deficiency. Damage to a component identified as "structurally significant" must be reported in a manner which will assure that the damage and the manner in which it is inflicted is evaluated, and the results of that evaluation disseminated to the operators and airframe manufacturers. Second, damage to a component of this type should be reported regardless of whether it was incurred during flight, ground operations, or maintenance. Finally, damage suffered by these types of structures should be investigated by representatives of the operator, airframe manufacturer, and the Administrator.

#### Surveillance of Industry Practices by Federal Aviation Administration

The Safety Board believes that the facts, conditions, and circumstances of this accident and the information obtained during the investigation illustrate deficiencies in the aviation industry ranging from aircraft design through operations. The Safety Board recognizes that resource limitations prohibit the FAA from exercising rigid oversight of all facets of the industry. Therefore, the FAA must exercise its authority by insuring that aircraft designs do comply with regulations, that manufacturers quality control programs are effective, that aircraft operators adhere to a proper maintenance program; and that operational procedures adopted by the carriers consider even unique emergencies which might be encountered.

In summary, the Safety Board recognizes that the overall safety record of the current generation of jet aircraft clearly indicates that the regulatory structure under which U.S. commercial aviation operates and the industry's commitment to safety is basically sound. The Safety Board, however, is concerned that this accident may be indicative of a climate of complacency. Although the accident in Chicago on May 25 involved only one manufacturer and one carrier, the Safety Board is concerned that the nature of the identified deficiencies in design, manufacturing, quality control, maintenance and operations may reflect an environment which could involve the safe operation of other aircraft by other carriers.

### 3. CONCLUSIONS

#### 3.1 Findings

1. The engine and pylon assembly separated either at or immediately after liftoff. The flightcrew was committed to continue the takeoff.
2. The aft end of the pylon assembly began to separate in the forward flange of the aft bulkhead.
3. The structural separation of the pylon was caused by a complete failure of the forward flange of the aft bulkhead after its residual strength had been critically reduced by the fracture and subsequent service life.
4. The overload fracture and fatigue cracking on the pylon aft bulkhead's upper flange were the only preexisting damage on the bulkhead. The length of the overload fracture and fatigue cracking was about 13 inches. The fracture was caused by an upward movement of the aft end of the pylon which brought the upper flange and its fasteners into contact with the wing clevis.
5. The pylon to wing attach hardware was properly installed at all attachment m-
6. AU electrical power to the NO. 1 a.c. generator bus and No. 1 d.c. bus was lost after the pylon separated. The captain's flight director instrument, the stall warning system, and the slat disagreement warning light systems were rendered inoperative. Power to these buses was never restored.
7. The No. 1 hydraulic system was lost when the pylon separated. Hydraulic systems No. 2 and No. 3 operated at their full capability throughout the flight. Except for spoiler panels No. 2 and No. 4 on each wing, all flight controls were operating.
8. The hydraulic lines and followup cables of the drive actuator for the left wing's outboard leading edge slat were severed by the separation of the pylon and the left wing's outboard slats retracted during climbout. The retraction of the slats caused an asymmetric stall and subsequent loss of control of the aircraft.
9. The flightcrew could not see the wings and engines from the cockpit. Because of the loss of the slat disagreement light and the stall warning system, the flightcrew would not have received an electronic warning of either the slat asymmetry or the stall. The loss of the warning systems created a situation which afforded the flightcrew an inadequate opportunity to recognize and prevent the ensuing stall of the aircraft.

10. The flightcrew flew the aircraft in accordance with the prescribed emergency procedure which called for the climbout to be flown at  $V_2$  speed.  $V_2$  speed was 6 KIAS below the stall speed for the left wing. The deceleration to  $V_2$  speed caused the aircraft to stall. The start of the left roll was the only warning the pilot had of the onset of the stall.
11. The pylon was damaged during maintenance performed on the accident aircraft at American Airline's Maintenance facility at Tulsa, Oklahoma, on March 29 and 30, 1979.
12. The design of the aft bulkhead made the flange vulnerable to damage when the pylon was being separated or attached.
13. American Airlines engineering personnel developed an ECO to remove and reinstall the pylon and engine as a single unit. The ECO directed that the combined engine and pylon assembly be supported, lowered, and raised by a forklift. American Airlines engineering personnel did not perform an adequate evaluation of either the capability of the forklift to provide the required precision for the task, or the degree of difficulty involved in placing the lift properly, or the consequences of placing the lift improperly. The ECO did not emphasize the precision required to place the forklift properly.
14. The FAA does not approve the carriers' maintenance procedures, and a carrier has the right to change its maintenance procedures without FAA approval.
15. American Airlines personnel removed the aft bulkheads bolt and bushing before removing the forward bulkhead attach fittings. This permitted the forward bulkhead to act as a pivot. Any advertent or inadvertent loss of forklift support to the engine and pylon assembly would produce an upward movement at the aft bulkhead's upper flange and bring it into contact with the wing clevis.
16. American Airlines maintenance personnel did not report formally to their maintenance engineering staff either their deviation from the removal sequence contained in the ECO or the difficulties they had encountered in accomplishing the ECO's procedures.
17. American Airline's engineering personnel did not perform a thorough evaluation of all aspects of the maintenance procedures before they formulated the ECO. The engineering and supervisory personnel did not monitor the performance of the ECO to insure either that it was being accomplished properly or if their maintenance personnel were encountering unforeseen difficulties in performing the assigned tasks.



18. The nine situations in which damage was sustained and cracks were found on the upper flange were limited to 1hme operations wherein the engine and pylon assembly was supported by a forklift.
19. On December 19, 1978, and February 22, 1979, Continental Airlines maintenance personnel damaged aft bulkhead upper flanges in a manner similar to the damage noted on the accident aircraft. The carrier classified the cause of the damage as maintenance error. Neither the air carrier nor the manufacturer interpreted the regulation to require that it further investigate or report the damages to the FAA.
20. The original certification's fatigue-damage assessment was in conformance with the existing requirements.
21. The design of the stall warning system lacked sufficient redundancy; there was only one stickshaker motor; and further, the design of the system did not provide for crossover information to the left and right stall warning computers from the applicable leading edge slat sensors on the opposite side of the aircraft.
22. The design of the leading edge slat system did not include positive mechanical locking devices to prevent movement of the slats by external loads following a failure of the primary controls. Certification was based upon acceptable night characteristics with an asymmetrical leading edge slat condition.
23. At the time of DC-10 certification, the structural separation of an engine pylon was not considered. Thus, multiple failures of other systems resulting from this single event was not considered.

32 Probable Cause

The National Transportation Safety Board determines that the probable cause of this accident was the asymmetrical stall and the ensuing roll of the aircraft because of the uncommanded retraction of the left wing outboard leading edge slats and the loss of stall warning and slat disagreement indication systems resulting from maintenance-induced damage leading to the separation of the No. 1 engine and pylon assembly at a critical point during takeoff. The separation resulted from damage by improper maintenance procedures which led to failure of the pylon structure.

Contributing to the cause of the accident were the vulnerability of the design of the pylon attach points to maintenance damage; the vulnerability of the design of the leading edge slat system to the damage which produced asymmetry; deficiencies in Federal Aviation Administration surveillance and reporting systems which failed to detect and prevent the use of improper maintenance procedures; deficiencies in the practices and communications among the operators, the manufacturer, and the FAA which failed to determine and disseminate the particulars regarding previous maintenance damage incidents; and the intolerance of prescribed operational procedures to this unique emergency.

#### 4. Safety Recommendations

As a result of this accident, the National Transportation Safety Board has recommended that the Federal Aviation Administration:

**Issue** immediately an emergency Airworthiness Directive to inspect **all** pylon attach points on **all DC-10** aircraft by approved inspection methods. (Class I, Urgent Action) (A-79-41)

Issue a telegraphic **Airworthiness** Directive to require an immediate inspection of **all DC-10** aircraft in which an engine pylon assembly has been removed and reinstalled for damage to the **wing-mounted** pylon aft bulkhead, including its forward flange and the attaching spar web and fasteners. Require removal of any sealant which may hide a crack in the flange area and employ eddy-current or other approved techniques to ensure detection of such damage. (Class I, Urgent Action) (A-79-45)

**Issue** a Maintenance Alert Bulletin directing FAA Maintenance inspectors to contact their assigned carriers and advise them to immediately discontinue **the practice** of lowering and raising the **pylon** with the engine **still** attached. **Carriers should adhere** to the **procedure** recommended by the Douglas Aircraft Company Service Bulletin which include **removing** the engine from the **pylon** before removing the **pylon** from the **wing**. (Class I, Urgent Action) (A-79-46)

Issue a **Maintenance Alert Bulletin** to **U.S.** certificated air carriers, and notify States that have regulatory responsibilities over foreign air carriers operating **DC-10** aircraft, to require appropriate structural inspections of the engine pylons following engine failures involving significant imbalance conditions or severe side loads. (Class I, Urgent Action) (A-79-52)

**Incorporate** in type certification procedures consideration of:

- (a) Factors which affect maintainability, such as accessibility for inspection, positive or redundant retention of connecting hardware and the clearances of interconnecting parts in the design of critical structural elements; and
- (b) Possible failure combinations which can result from primary structural damage in areas through which essential systems are routed. (Class U--Priority Action) (A-79-98)

Insure that the design of transport category aircraft provides **positive protection** against **asymmetry** of lift devices during critical phases of flight; **or**, if certification is based upon

#### 4. Safety Recommendations

As a result of this accident, the National Transportation Safety Board has recommended that the Federal Aviation Administration

**Issue** immediately an emergency Airworthiness Directive **to** inspect **all** pylon **attach** points on **all** DC-10 aircraft by approved inspection methods. (Class I, Urgent Action) (A-73-41)

Issue a telegraphic Airworthiness Directive to require an immediate **inspection of all** DC-10 aircraft in which an engine pylon assembly has been removed and reinstalled for damage to the **wing-mounted** pylon aft bulkhead, including its forward flange and the attaching spar web and fasteners. Require removal of any sealant which may hide a crack in the flange area and employ eddy-current or other **approved** techniques **to** ensure detection **of** such damage. (Class I, Urgent Action) (A-79-45)

**Issue** a Maintenance Alert Bulletin directing FAA Maintenance inspectors **to** contact **their** assigned carriers and advise them **to** **immediately** discontinue the **practice of lowering and raising the pylon with the engine still attached.** **Carriers should adhere** to the procedure recommended by the Douglas Aircraft Company Service Bulletin which include removing the engine from the pylon before removing the pylon from the wing. (Class I, Urgent Action) (A-79-06)

Issue a **Maintenance Alert Bulletin to U.S.** certificated air carriers, and notify States that have **regulatory** responsibilities over foreign air carriers operating DC-10 aircraft, **to** require appropriate structural inspections of **the** engine pylons following **engine** failures involving significant imbalance conditions **or** severe side loads. (Class I, Urgent Action) (A-19-52)

**Incorporate** in type certification procedures consideration of:

- (a) Factors which affect maintainability, such as accessibility **for** inspection, positive **or** redundant retention of connecting hardware **and** the clearances **of** interconnecting parts in the design of critical structural elements; and
- (b) **Possible failure combinations** which can result from primary structural damage in areas through **which** essential systems are routed. (Class U--Priority Action) (A-79-98)

**Insure** that the design of transport category aircraft provides positive protection against **asymmetry of lift devices** during critical phases **of** flight; **or, if certification is based upon**

demonstrated controllability of the aircraft under condition of asymmetry, insure that asymmetric warning systems, stall warning systems, or other critical systems needed to provide the pilot with information essential to safe flight are completely redundant. (Class U--Priority Action) (A-79-99)

initiate and continue strict and comprehensive surveillance efforts in the following areas:

- (a) Manufacturer's quality control programs to assure full compliance with approved manufacturing and process specifications; and
- (b) Manufacturer's service difficulty and service information collection and dissemination systems to assure that all reported service problems are properly analyzed and disseminated to users of the equipment, and that appropriate and timely corrective actions are effected. This program should include full review and specific FAA approval of service bulletins which may affect safety of flight. (Class II--Priority Action) (A-79-100)

Assure that the Maintenance Review Board fully considers the following elements when it approves an Airline/Manufacturer Maintenance Program:

- (a) Hazard analysis of maintenance procedures which involve removal, installation, or work in the vicinity of structurally significant <sup>1/</sup> components in order to identify and eliminate the risk of damage to these components;
- (b) Special inspections of structurally significant components following maintenance affecting these components; and
- (c) The appropriateness of permitting "On Condition\* maintenance and, in particular, the validity of sampling inspection as it relates to the detection of damage which could result from undetected flaws or damage to structurally significant elements during manufacture or maintenance. (Class II--Priority Action) (A-79-101)

Require that air carrier maintenance facilities and other designated repair stations:

<sup>1/</sup> Structurally significant items as defined in Appendix 1 of Advisory Circular 120-17A-"Maintenance Control By Reliability Methods."

- (a) Make a hazard analysis evaluation of proposed maintenance procedures which deviate from those in the manufacturer's manual and which involve removal, installation, or work in the vicinity of structurally significant components; and
- (b) Submit proposed procedures and analysis to the appropriate representative of the Administrator, FAA, for approval. (Class 11--Priority Action) (A-79-102)

Revise 14 CFR 121.707 to more clearly define "major" and "minor" repair categories to insure that the reporting requirement will include any repair of damage to a component identified as "structurally significant." (Class 11--Priority Action) (A-79-103)

Expand the scope of surveillance of air carrier maintenance by:

- (a) Revising 14 CFR 121 to require that operators investigate and report to a representative of the Administrator the circumstances of any incident wherein damage is inflicted upon a component identified as "structurally significant" regardless of the phase of flight, ground operation, or maintenance in which the incident occurred; and
- (b) Requiring that damage reports be evaluated by appropriate FAA personnel to determine whether the damage cause is indicative of an unsafe practice and assuring that proper actions are taken to disseminate relevant safety information to other operators and maintenance facilities. (Class IS--Priority Action) (A-79-104)

Revise operational procedures and instrumentation to increase stall margin during secondary emergencies by:

- (a) Evaluating the takeoff-climb airspeed schedules prescribed for an engine failure to determine whether a continued climb at speeds attained in excess of  $V_2$ , up to  $V_2 + 10$  knots, is an acceptable means of increasing stall margin without significantly degrading obstacle clearance.
- (b) Amending applicable regulations and approved flight manuals to prescribe optimum takeoff-climb airspeed schedules; and
- (c) Evaluating and modifying as necessary the logic of flight director systems to insure that pitch commands in the takeoff and go-around modes correspond to optimum airspeed schedules as determined by (a) and (b) above. (Class 11--Priority Action) (A-79-105)

BY THE NATIONAL TRANSPORTATION SAFETY BOARD

/s/ JAMES B. KING  
Chairman

/s/ ELWOOD T. DRIVER  
Vice Chairman

/s/ FRANCIS H. McADAMS  
Member

PATRICIA A. GOLDMAN  
Member

/s/ G.H. PATRICK BURSLEY  
Member

December 21, 1979

5. APPENDIXES

Appendix A

Investigation and Hearing

1. Investigation

The National Transportation Safety Board was notified of the accident about 1615 e.d.t., on May 25, 1979, and immediately dispatched an investigative team to the scene. Investigative groups were established for operations, air traffic control, aircraft structures, aircraft systems, powerplants, weather, human factors, witnesses, cockpit voice recorders, night data recorder, maintenance records, aircraft performance, metallurgy, and engineering.

Parties to the investigation were the Federal Aviation Administration, American Airlines, Inc., Douglas Aircraft Company, Allied Pilots Association, Flight Engineers International Association, Association of Professional Flight Attendants, General Electric Company, Inc., and the Professional Air Traffic Controller Organization.

2. Public Hearing

A 10-day public hearing was held in Rosemont, Illinois, beginning July 30, 1979. Parties represented at the hearing were the Federal Aviation Administration, American Airlines, Inc., Douglas Aircraft Company, Allied Pilots Association, Flight Engineers International Association, Transport Workers Union, and the Air Line Pilots Association.

D

Appendix B

Personnel Information

Captain Halter ti. Lux, 53, was employed by American Airlines Inc., November 1, 1950. He held Airline Transport Certificate No. 271336 with an aircraft multiengine land rating and commercial privileges in aircraft single engine land and sea. He was type-rated in Convair CV 240, CV 990, Lockheed L-188, Boeing 727, Boeing 707, McDonnell-Douglas DC-6, 7, and 10 aircraft. His first-class medical certificate was issued December 12, 1978, and he was required to "have available glasses for a near vision while flying."

Captain Lux qualified as captain on Douglas DC-10 aircraft on December 15, 1971. He passed his proficiency check on July 14, 1978; his last line check on September 21, 1978; and he completed recurrent training February 16, 1979. The captain had flown 22,500 hrs, 3,000 of which were as captain in the DC-10. During the last 90 days and 24 hrs before the accident, he had flown 104 hrs and 7 hrs 46 min, respectively. At the time of the accident, the captain had been on duty about 7 hrs 5 min, 4 hrs 30 min of which were flight time. He had been off duty 11 hrs 28 min before reporting for duty on the day of the accident.

First Officer James R. Dillard, 49, was employed by American Airlines, Inc., June 20, 1966. He held Commercial Pilot Certificate No. 1428394 with single, multiengine land, and instrument ratings. His first-class medical certificate was issued March 16, 1979, and he was required to "wear lenses that correct for distant vision and possess glasses that correct for near vision while exercising the privileges of his airman certificate."

First Officer Dillard qualified as first officer on the DC-10 on July 12, 1977. He passed his original proficiency check on July 12, 1977, and his recurrent training on August 18, 1978. The first officer had flown about 9,275 hrs, 1,080 hrs of which were in the DC-10. During the last 90 days and 24 hrs before the accident, he had flown 148 hrs and 7 hrs 46 min, respectively. The first officer's duty and rest times preceding the accident were the same as the captain's.

Flight Engineer Alfred F. Udovich, 56, was employed by American Airlines, Inc., January 10, 1955. He held Flight Engineer Certificate No. 1305944 with reciprocating engine and turbojet powered aircraft ratings. His second-class medical certificate was issued on February 8, 1979, and he was required to "wear correcting glasses while exercising the privileges of his airmen certificate."

Flight Engineer Udovich qualified on the DC-10 on September 26, 1971. After flying other equipment, he requalified in the DC-10 on October 6, 1978. The flight engineer had flown about 15,000 hrs, 750 hrs of which were in the DC-10. During the last 90 days and 24 hrs before the accident, he had flown 192 hrs and 7 hrs 46 min, respectively. The flight engineer's duty and rest time preceding the accident were the same as the captain's.

The 10 flight attendants were qualified in the DC-10 in accordance with applicable regulations and had received the required training.

I



Appendix C

Aircraft Information

McDonnell-Douglas DC-10-10, N110AA

The aircraft, manufacturer's serial No. 46510, fuselage No. 22, was delivered February 25, 1972. A review of the aircraft's flight logs and maintenance records showed that no mechanical discrepancies were noted for May 24, 1979. The logs for May 25, 1979, the day of the accident, had not been removed from the logbook and were destroyed in the accident. The review of the records disclosed no data which the maintenance review group characterized as other than routine.

The aircraft was powered by three General Electric CF6-6D engines rated at 40,000 lbs of thrust for takeoff.

The following statistical data were compiled:

■ 4

Aircraft

Total hours	19.871
Last "C" check	March 28, 1979
Hours at "C" check	19.530
Hours since "C" check	341

Powerplants

<u>Engine</u>	<u>No. 1</u>	<u>No. 2</u>	<u>No. 3</u>
Serial No.	451179	451305	451118
Date of Installation	May 1, 1979	November 7, 1978	April 2, 1979
Total Time	16,363	15,770	16,856
Total Cycles	6,877	6,933	7,444

The "C" check is accomplished every 3,600 hrs of operation, and the company's maintenance facility at Tulsa, Oklahoma, is the only station where this check is accomplished. Structural sample items and items controlled to time frequency changes and inspection are scheduled to be accomplished in conjunction with "C" checks. The manufacturer's Service Bulletins Nos. 54-48, and 54-59. replacement of the forward and aft wing pylon spherical bearings, were accomplished during the March 28, 1979, "C" check.

Forty-five Airworthiness Directives have been issued for the DC-10, 37 had been complied with; the remaining directives were not applicable to N110AA.

Seven Airworthiness Directives were issued for the engine installation and 6 were completed; the remainder were not applicable to N110AA.

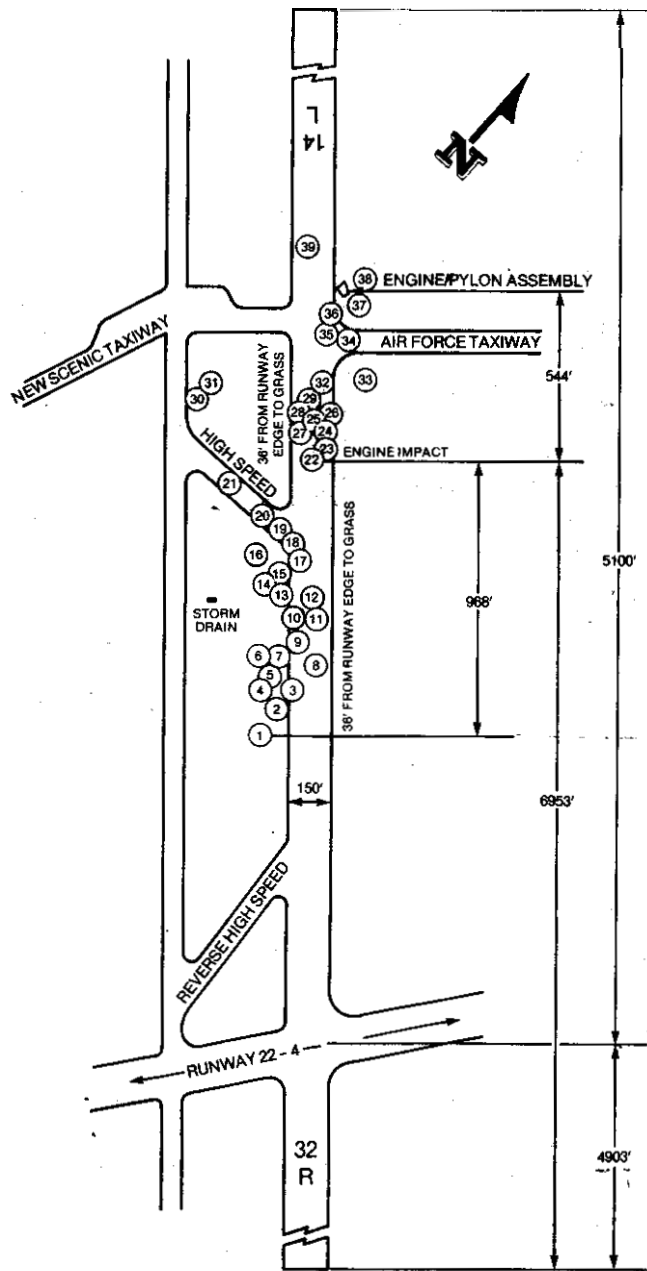

**RUNWAY LEGEND**

- |  |  |
|--|--|
| 1. Pylon Fairing (Fiberglass).   | 16. Bolt Match to No. 21.  |
| 2. Seal and Torn Metal.  | 17. Sheet Metal ARB 1680 (Bulkhead Type).                          |
| 3. Pylon Fairing (Fiberglass).   | 18. Fuel Line with DBL Wall Coupling with Fuel Drain "T" Coupling. |
| 4. Pylon Thrust Line Shim Washer.  | 19. Fan Cowl ASL 0209-2 (275 707-04).                              |
| 5. Flange from Pylon Thrust Link Bushing.  | 20. Acoustic Material.   |
| 6. Pylon Pneumatic Fitting.  | 21. Sheared Bolt and Nut 1/2" Dia.                                 |
| 7. Sheet Metal AUB 7108-413. Sheet Metal ARB 1679-21NC. Steel Ferrule. Pneumatic Duct Clamp. (Piece) 6" Dia. 1/4" Pneumatic Line (2 1/4" Long). Wing Sheet Metal ARB 2339-5 with Captive Nuts. | 22. Engine Pylon Impact.   |
| 8. Standoff Bracket with 2 Rubber Covered Clamps.  | 23. Inlet Acoustic Face Sheet Piece.                               |
| 9. Rib Section.  | 24. Right Side Cowling Pieces, CSD SV Door.                        |
| 10. Fuel Line ARL-0124-23.   | 25. Cowling Piece.   |
| 11. Control Bracket AUN-7020-1 NUN 6001-401.   | 26. Cowling Inlet.   |
| 12. Piece of Mono Ball (Thrust Line).  | 27. Right Side Fan Cowl (Piece).                                   |
| 13. Thrust Link Washer.  | 28. Fan Blades.  |
| 14. Wing Leading ARB 1065-1G S# Mac 22 (Wing L.E. to Pylon Interface Edge with Jay Box).   | 29. Engine Drain.  |
| 15. Control Bracket AUN 7009-1 (4 Pulleys).  | 30. Right Hand Fan Cowl.   |
|  | 31. Front Spar Attach Bulkhead Piece.                              |
|  | 32. Pylon Thrust Line Bushing.                                     |
|  | 33. CSD Generator Gearbox.   |
|  | 34. Section of Front Spar Attach Bulkhead.                         |
|  | 35. Ignition Unit.   |
|  | 36. Reverser Actuator.   |
|  | 37. Hinged Cowling.  |
|  | 38. Control Bracket.   |
|  | 39. Fuel Line (Pylon).   |



**APPENDIX D**

**NATIONAL TRANSPORTATION SAFETY BOARD**

Wreckage Diagram  
 American Airlines  
 Flight No. 191  
 Chicago O'Hare International Airport

**MAIN WRECKAGE LEGEND**

1. Aileron Balance Panel—Burned and Separated.
2. Aileron Structure (Left)—Burned and Separated.
3. Wing Tip (Left)—Burned and Separated.
4. Thrust Link Wing Attach Fitting.
5. Aileron Outboard (Left)—Burned and Separated.
6. Slat Actuator Outboard (Left).
7. Flap Actuator—Burned.
8. Wing Spar—Partial Section, Burned.
9. Stabilizer Tip—Separated and Burned.
10. Outflow Valve Complex.
11. Fire Bottles, Engine.
12. Nose Gear Steering Cylinder.
13. Fuselage Section—Cockpit Clear View Window.
14. Aileron, Right Wing Outboard, Separated and Burned.
15. Cowling, #2 Engine Fan Section, Burned.
16. Air Drive Generator.
17. Door, Avionics Nose Wheel.
18. Elevator Section Near Left Outboard.
19. #2 Engine.
- 19A. Two Left Main Gear Wheels; Tires Deflated.
20. Stabilizer, Left, With Logo Light.
21. Elevator, Partial Section.
22. Flaps, Trailing Edge, Complete.
23. Monoball Mount, #1 Engine Forward.
24. Avionics Compartment Material (15' Area).
25. Bases for Two Crew Seats.
26. Throttle Quadrant.
27. Pedestal Items.
28. Center Altimeter.
29. Portable Water Tank.
30. Primary Heat Exchanger Cooling Turbine.
31. Slat Actuator, Inboard.
32. Pylon Mount Bracket (Alt), Separated and Broken. (#1 Pylon)

30. Vertical Fin With Upper Rudder Attached (Separated).
31. Flight Engineer Panel, C/B Panel, Main Crew O<sub>2</sub> Bottle.
32. Wing Tip (Right).
33. Slat (Unidentified).
33. Flap, Trailing Edge, (Right).
34. Crew Seat Bottom.
35. Cargo Door.
35. Engine Cowling Inlet, (#2).
36. Cabin Entry Door.
36. Tail Area, Pressure Bulkhead Alt, Including the Following:  
APU.  
Tail Cone Actuator.  
Bulkhead With CSD and Engine Oil Service Lines.  
Section of Vertical Fin With Part of Lower Rudder.  
-Baffle Fittings (Partial).  
Horizontal Stabilizer (Partial).
37. Engine #3.
37. Right Main Gear, Wheels Separated from Strut.
38. Flap, Trailing Edge, Right.
38. #2 Aux Hydraulic Pumps.
39. Main Cabin Fuelage Doors, Left and Right.
39. Fuselage Section.
39. Left Inboard Flap.
39. Piece of Stabilizer Chain.
40. Cargo Compartment Floor Rollers.
41. Fuselage Section With Cabin Door.
42. Right Wing Section With Cabin Door.
43. Slat, (Unidentified).
44. Boost Pumps.
44. Air Cycle Machine.
45. Right Wing Section.
46. #1 Pylon Alt Monoball Mount.
47. Flight Recorder.
48. Voice Recorder.

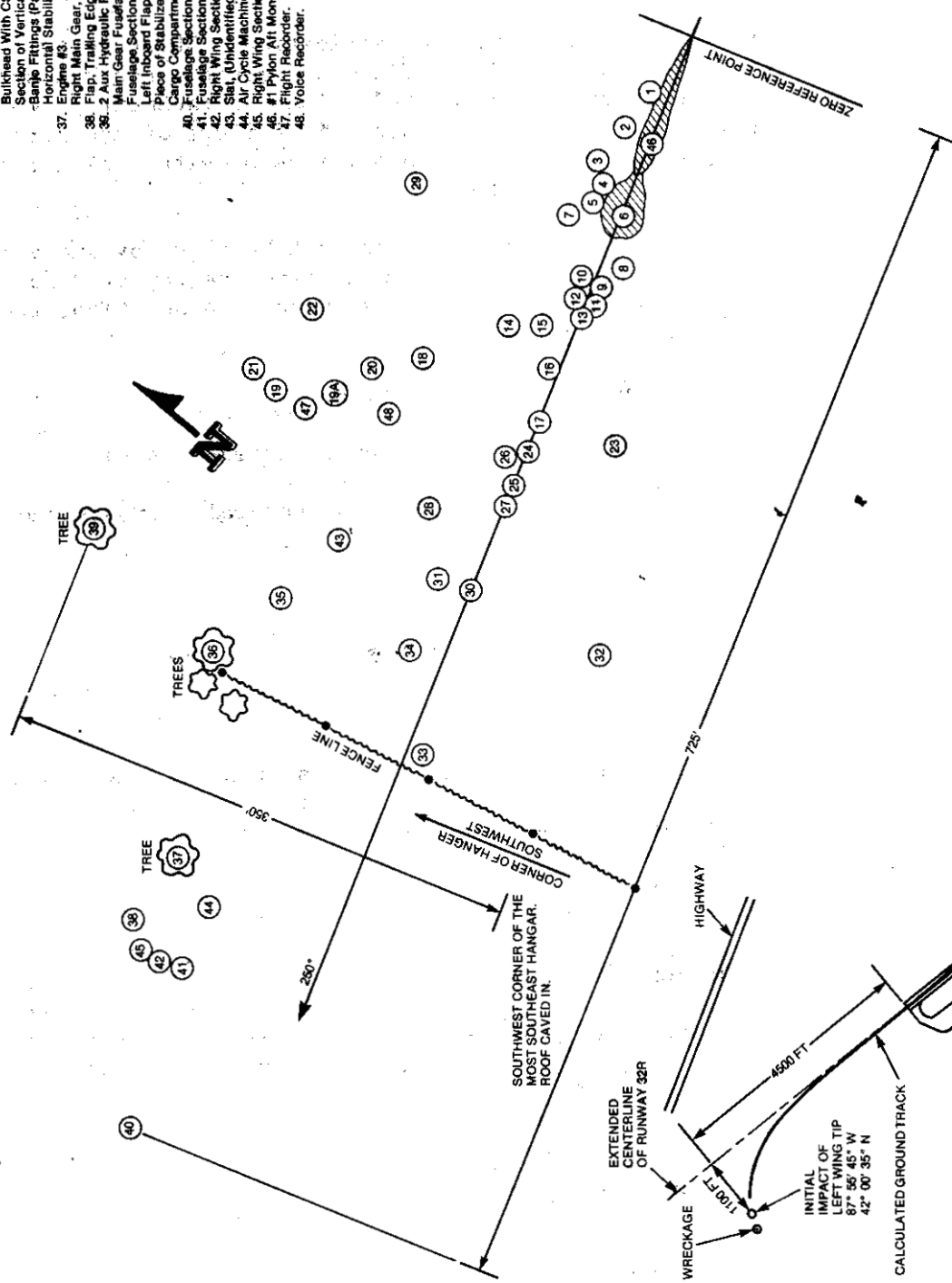

APPENDIX D  
WRECKAGE DIAGRAM

APPENDIX E

The following 1965 airworthiness regulations were pertinent to the accident investigation.

§ 25.571 Fatigue evaluation of flight structure.

- (a) Strength, detail design, and fabrication. *Those* parts of the structure (including wings, fixed and movable control surfaces, the fuselage, and their related primary attachments), whose failure could result in catastrophic failure of the airplane, must be evaluated under the provisions of either paragraph (b) or (c) of this section.
- (b) Fatigue strength. The structure must be shown by analysis, tests, or both, to be able to withstand the repeated loads of variable magnitude expected in service. In addition, the following apply:
  - (1) The evaluation must include --
    - (i) The typical loading spectrum expected in service;
    - (ii) Identification of principal structural elements and detail design points, the fatigue failure of which could cause catastrophic failure of the airplane; and
    - (iii) An analysis or repeated load tests, or a combination of analysis and load tests, of principal structural elements and detail design points identified in subdivision (ii) of this subparagraph.
  - (2) The service history of airplanes of similar structural design, taking due account of differences in operating conditions and procedures, may be used.
  - (3) If substantiation of the pressure cabin by fatigue tests is required, the cabin, or representative parts of it, must be cycle-pressure tested, using the normal operating pressure plus the effects of external aerodynamic pressure combined with the flight loads. The effects of flight may be represented by an increased cabin pressure or may be omitted if they are shown to have no significant effect upon fatigue.

(c) Fail safe strength. It must be shown by analysis, tests, or both., that catastrophic failure or excessive, structural deformation, that could adversely affect the flight characteristics of the airplane, are not probable after fatigue failure or obvious partial failure of a single principal structural element. After these types of failure of a single principal structural element, the remaining structure must be able to withstand static loads corresponding to the following:

- (1) An ultimate maneuvering load factor of 2.0 at  $V_c$ .
- (2) Gust loads as specified in § 25.341 and 25.351(b), except that these gust loads are considered to be ultimate loads and the gust velocities, are --
  - (i) At speed  $V_n$ , 49 fps from sea level to 20,000 feet, thereafter decreasing linearly to 28 fps at 50,000 feet;
  - (ii) At speed  $V_c$ , 33 fps from sea level to 20,000 feet, thereafter decreasing linearly to 16.5 fps at 50,000 feet; and
  - (iii) At speed  $V_d$ , 15 fps from sea level to 20,000 feet, thereafter decreasing linearly to 6 fps at 50,000 feet..
- (3) Eighty percent of the limit loads resulting from the conditions specified in § 25.427. These loads are considered to be ultimate loads.
- (4) Eighty percent of the limit maneuvering loads resulting from the conditions specified in § 25.351(a), except that the load need not exceed 100 percent of the critical load obtained in compliance with § 25.351(a), using a pilot effort of 180 pounds. This load is an ultimate load.

The loads prescribed in this paragraph must be multiplied by a factor of 1.15 unless the dynamic effects of failure under static load are otherwise considered. For a pressurized cabin, the normal operating pressures combined with the expected external aerodynamic pressures must be applied simultaneously with the flight loading conditions specified in this paragraph.

\* \* \* \*

§ 25.671 General.

- (a) Each control and control system must operate with the ease, smoothness, and positiveness appropriate to its function.
- (b) Each element of each flight control system must be designed, or distinctively and permanently marked, to minimize the probability of incorrect assembly that could result in the malfunctioning of the system.
- (c) Each tab control system must be designed so that disconnection or failure of any element at speeds up to  $V_c$  cannot jeopardize safety.
- (d) Each adjustable stabilizer must have means to allow any adjustment necessary for continued safety of the flight after the occurrence of any reasonably probable single failure of the actuating system.

\* \* \* \*

§ 25.675 stops.

- (a) Each control system must have stops that positively limit the range of motion of the control surfaces.
- (b) Each stop must be located so that wear, slackness, or take-up adjustments will not adversely affect the control characteristics of the airplane because of a change in the range of surface travel.
- (c) Each stop must be able to withstand any loads corresponding to the design conditions for the control system.

\* \* \* \*

§ 25.685 Control system details.

- (a) Each detail of each control system must be designed and installed to prevent jamming, chafing, and interference from cargo, passengers, or loose objects.
- (b) There must be means in the cockpit to prevent the entry of foreign objects into places where they would jam the system.
- (c) There must be means to prevent the slapping of cables or tubes against other parts.
- (d) Sections 25.689 and 25.693 apply to cable systems and joints.

\* \* \* \*

§ 25.689 Cable systems.

- (a) Each cable, cable fitting, **turn-buckle**, splice, and pulley must be approved. In addition --
  - (1) No cable smaller than 1/8 inch in diameter may be used in the aileron, elevator, or rudder systems; and
  - (2) Each cable system must be designed so that there will be no hazardous change in cable tension throughout the range of travel under operating conditions and temperature variations.
- (b) Each kind and size of pulley must correspond to the cable with which it is used. Pulleys and sprockets must have closely fitted guards to prevent the cables and chains from being displaced or fouled. Each pulley must lie in the plane passing through the cable so that the cable does not rub against the pulley flange.
- (c) Fairleads must be installed so that they do not cause a change in cable direction of more than three degrees.
- (d) Clevis pins subject to load or motion and retained only by cotter pins.

\* \* \* \*

§ 25.701 Flap interconnection.

- (a) The motion of flaps on opposite sides of the plane of symmetry must be synchronized by a mechanical interconnection unless the airplane has safe flight characteristics with the flaps retracted on one side and extended on the other.
- (b) If a mechanical interconnection is used, there must be means to prevent hazardous unsymmetrical operation of the wing flaps after any reasonably possible single failure of the flap actuating system.
- (c) If a wing flap interconnection is used, it must be designed to account for the applicable unsymmetrical loads, including those resulting from flight with the engines on one side of the plane of symmetry inoperative and the remaining engines at takeoff power.
- (d) For airplanes with flaps that are not subjected to slipstream conditions, the structure must be designed for the loads imposed when the wing flaps on one side are carrying the most severe load occurring in the prescribed symmetrical conditions and those on the other side are carrying not more than 80 percent of that load.

\* \* \* \*

§ 25.1309 Equipment systems and installations.

- (a) The equipment, systems, and installations whose functioning is required by this **subchapter**, must be designed and installed to ensure that they perform their intended functions under any **foreseeable operating condition**.
- (b) The equipment, systems, and installations must be designed to prevent hazards to the airplane if they malfunction or fall.
- (c) Each installation whose functioning is required by this subchapter, and that requires a power supply, is an **"essential load"** on the power supply. The power sources and the **system must** be able to supply the following power loads in probable operating combinations and for probable durations:
  - (1) Loads connected to the system with the system functioning normally.
  - (2) **Essential loads, after failure of any one prime mover, power converter, or energy storage device.**
  - (3) **Essential loads after failure of --**
    - (i) Any one engine, on two- or three-engine airplanes; and
    - (ii) Any two engines on four-or-more-engine airplanes.
- (d) In determining compliance with paragraph (c) (2) and (3) of this section, the power loads may be assumed to be reduced under a monitoring procedure consistent with safety in the kinds of operation authorized. Loads not required in controlled flight need not be considered for the two-engine-inoperative condition, on airplanes with four or more engines.
- (e) In showing compliance with paragraphs (a) and (b) of this section with regard to the electrical system and equipment design and installation, critical environmental conditions **must** be considered. For electrical generation, distribution, and utilization equipment required by or used in complying with this chapter, except equipment covered by Technical Standard Orders containing environmental test procedures, the ability to provide continuous, safe service under foreseeable environmental conditions may be shown by environmental tests, design analysis, or reference to previous comparable service experience on other aircraft.

\* \* \* \*



§ 25.1435 Hydraulic systems.

(a) Design. Each hydraulic system must be designed as follows:

- (1) Each element of the hydraulic system must be designed to withstand, without detrimental, permanent deformation, any structural loads that may be imposed simultaneously with the maximum operating hydraulic loads.
- (2) Each element of the hydraulic system must be designed to withstand pressures sufficiently greater than those prescribed in paragraph (b) of this section to show that the system will not rupture under service conditions.
- (3) There must be means to indicate the pressure in each main hydraulic power system.
- (4) There must be means to ensure that no pressure in any part of the system will exceed a safe limit above the maximum operating pressure of the system, and to prevent excessive pressures resulting from any fluid volumetric change in lines likely to remain closed long enough for such a change to take place. The possibility of detrimental transient (surge) pressures during operation must be considered.
- (5) Each hydraulic line, fitting, and component must be installed and supported to prevent excessive vibration and to withstand inertia loads. Each element of the installation must be protected from abrasion, corrosion, and mechanical damage.
- (6) Means for providing flexibility must be used to connect points in a hydraulic fluid line, between which relative motion or differential vibration exists.

(b) Tests. Each element of the system must be tested to a proof pressure of 1.5 times the maximum pressure to which that element will be subjected in normal operation, without failure, malfunction, or detrimental deformation of any part of the system.

(c) Fire protection. Each hydraulic system using flammable hydraulic fluid must meet the applicable requirements of §§ 25.863, 25.1183, 25.1185, and 25.1189.

\* \* \* \*

SPECIAL AIRFRAME CONDITIONS

1. Control System

In lieu of the requirements of §§ 25.671(c) and (d) and 25.695, and the first sentence of § 25.677(c), the following apply:

(a) It must be shown by analysis or tests, or both, that the airplane is capable of continued safe flight and landing after any of the following failures or jamming in the flight control system and surfaces (including trim, lift, drag, and systems), within the normal flight envelope, without requiring exceptional piloting skill or strength:

(1) Any single failure, excluding jamming (for example, disconnection or failure of mechanical element, or structural failure of hydraulic components, such as actuators, control spool housing, and valves).

(2) Any combination of failures not shown to be extremely improbable, excluding jamming (for example, dual electrical or hydraulic system failures, or any single failure in combination with any probable hydraulic or electrical failure).

(3) Any jam in a control position normally encountered during takeoff, climb, cruise, normal turns, descent and landing, unless the jam is shown to be extremely improbable, or can be alleviated. A runaway of a flight control to an adverse position and jam must be accounted for if such runaway and subsequent jamming is not extremely improbable.

Probable malfunctions must have only minor effects on control system operation and must be capable of being readily counteracted by the pilot.

(b) The airplane must be designed to be controllable if all engines fail. Compliance with this requirement may be shown by analysis if the method has been shown to be reliable.

2. Continuous Turbulence

In addition to the requirements of § 25.305, the dynamic response of the airplane to vertical and lateral continuous turbulence must be taken into account.

APPENDIX F  
OFFICIAL USE

Applicable airworthiness directive **and related** correspondence,

79-15-05 McDONNELL DOUGLAS: Amendment 39-3515. Applies to Model DC-10-10, -10F, -30, -30F, -40 series airplanes certificated in all categories.

Compliance required as indicated. To assure immediate indication to the flight crew of any asymmetric wing slat condition, accomplish the following:

- a. Before further flight, after the effective date of this **AD**:
  - (1) Install two auto throttle/speed control computers in accordance with FAA approved type design data to provide stall warning **based on both right and left angle of attack sensors and on the positions of both outboard wing slat groups in addition to previously** required inputs, **or**;
  - (2) **Modify** the stall warning and auto slat system to provide information from two angle of attack sensors and the positions of both outboard wing slat groups to a single auto throttle/speed control computer in accordance with design data approved by the Chief, Aircraft Engineering Division, FAA Western Region. ■

NOTE: The stall warning and auto slat functions of the auto throttle/speed control computer are the functions required by this **AD**.

- b. Within 30 days after the effective date of this **AD**, add the following to the limitations section of the FAA approved Airplane Flight Manual:

"TAKEOFF WARNING

The slat function of the takeoff warning system must be operative for takeoff."

- c. Special flight permits may be issued in accordance with FAR 21.197 and 21.199 to operate airplanes to a base for the accomplishment of modifications required by this **AD**.
- d. Alternative modifications **or** other actions which provide an equivalent level of safety **may** be used when approved by the Chief, Aircraft Engineering Division, FAA Western Region.

This amendment becomes effective July 13, 1979.

On July 30, 1979, the FAA issued a Notice of Proposed Rule Making (NPRM), Docket No. 79-WE-17 AD. The NPRM proposed to adopt a new airworthiness directive that required increased redundancy of the DC-10 stall warning system. The airworthiness directive and the Safety Board's comments are cited below:

"McDonnell Douglas: Applies to Model DC-10, -10F, -30, -30F, -40 series airplanes certificated in all categories.

Compliance is required as indicated.

To reduce the probability of complete failure of the stall warning function, accomplish the following:

- (a) Within 1,500 hours time in service after the effective date of this AD:
  1. Install two (2) auto throttle/speed control computers, each of which receives information from both right and left angle of attack sensors and the positions of both outboard wing slat groups, in addition to other previously required inputs, in accordance with design data approved by the Chief, Aircraft Engineering Division, FAA Western Region.
  2. Install a stick shaker at the First Officer's position, in addition to that previously required at the Captain's position, with both stick shakers actuated by either auto throttle/speed control computer in accordance with approved type design data.
- (b) Special flight permits may be issued in accordance with FAR 21.197 and 21.199 to operate airplanes to a base for the accomplishment of modifications required by this AD
- (c) Alternative inspections, modifications or other actions which provide an equivalent level of safety may be used when approved by the Chief, Aircraft Engineering Division, FAA Western Region."

Department of Transportation  
Federal Aviation Administration  
Western Region  
Airworthiness Rules Docket  
P.O. Box 92007, World Postal Center  
Los Angeles, California 90009

Attention: Regional Counsel

Gentlemen:

The National Transportation Safety Board has reviewed your Notice of Proposed Rulemaking, Docket No. 79-WE-17 AD, which was published July 30, 1979, at 44 FR 4454.7. As you know, the Safety Board has just concluded a two week public hearing, associated with the investigation of the tragic American Airlines DC-10 accident at Chicago. Your proposal to amend 14 CFR 39.13 to require increased redundancy in the DC-10 stall warning system is in consonance with testimony received at the public hearing. The Board, therefore, concurs in the proposed rulemaking action.

Sincerely yours,

James B. King  
Chairman

Appendix G

Suspension and Restoration of the DC-10 Type Certificate:

The Model DC-10 aircraft is covered under Type Certificate No. A22WE held by the McDonnell-Douglas Corporation.

On May 28, 1979, 3 days after the accident, the FAA Western Region issued a telegraphic AD which required visual inspection of the inside forward flange of each wing engine pylon aft bulkhead for cracks and inspection or replacement of the bolts at the forward and aft ends of each wing to pylon thrust link assemblies.

On May 29, 1979, the AD was amended to require further inspections of certain engine pylon to wing attachment structure. On June 4, 1979, the May 28 AD was again amended telegraphically to require reinspection of certain Model DC-10 series aircraft which had undergone engine and pylon removal and installation. As a result of the inspections required by the amended AD, the FAA was informed of the existence of cracks in the wing pylon assemblies of mounting assemblies. Therefore, on June 6, 1979, the Administrator issued the following Emergency Order of Suspension which read, in part:

**"EMERGENCY ORDER OF SUSPENSION"**

Take notice that, upon consideration of all the evidence available, it appears to the Administrator of the Federal Aviation Administration as follows:

1. McDonnell-Douglas Corporation is now and at all times mentioned herein was the holder of Type Certificate No. A22WE for the Douglas DC-10 series aircraft.
2. On or about May 25, 1979, an accident occurred involving a McDonnell-Douglas DC-10 series aircraft at Chicago, Illinois.
3. Subsequent to said accident, on May 28, 1979, the Federal Aviation Administration acting by and through Leon C. Daugherty, Director, Western Region, issued an airworthiness directive applicable to all DC-10 series aircraft.
4. Thereafter, on May 29, 1979, the airworthiness directive was further amended to require additional inspections of the wing mounted engine pylon structure for cracks and integrity of the attachment support unit.
5. Thereafter, on June 4, 1979, the airworthiness directive was further amended to require reinspection of certain DC-10 series aircraft which had undergone engine and pylon removal and reinstallation.
6. As a result of the inspections required by the airworthiness directive, as amended, the FAA continues to be advised of the existence of cracks in the pylon mounting assemblies of certain

aircraft and it appears that the aircraft may not meet the applicable certification criteria of Part 25 of the Federal Aviation Regulations (FAR).

7. Moreover, the preliminary findings of an FAA post audit of the Model DC-10 aircraft type certification data indicates that the wing engine pylon assembly may not comply with the type certification basis set forth in FAR 25.571.

By reason of the foregoing circumstances, the Administrator has reason to believe that the Model DC-10 series aircraft may not meet the requirements of Section 603(a) of the Federal Aviation Act for a Type Certificate in that it may not be of proper design, material, specification, construction, and performance for safe operation, or meet the minimum standards, rules, and regulations prescribed by the Administrator.

Therefore, the Administrator finds that safety in air commerce or air transportation and the public interest require the suspension of the Type Certificate for the Model DC-10 Series aircraft issued to McDonnell-Douglas Corporation until such time as it can be ascertained that the DC-10 aircraft meets the certification criteria of Part 25 of the FAR and is eligible for a Type Certificate.

Furthermore, the Administrator finds that an emergency exists and that safety in air commerce or air transportation requires the immediate effectiveness of this Order.

THEREFORE, IT IS ORDERED, under authority contained in Sections 609 and 1005(a) of the Federal Aviation Act of 1958, as amended, that Type Certificate No. A22WE issued to McDonnell-Douglas Corporation be, and it hereby is, suspended on an emergency basis, said suspension to be effective on the date of this Order and until it is found by the Administrator that the Model DC-10 series aircraft meets the applicable certification criteria of Part 25 of the FAR and is eligible for a type certificate...."

On June 7, 1979, the Chief Counsel of the FAA issued two Orders of Investigation and Demand for Production of Material. The first Order concerned the maintenance and airworthiness procedures relating to the DC-10 and was directed to United States operators of the aircraft. The second Order was directed to McDonnell-Douglas Corporation and concerned the type certification of the Model DC-10 aircraft and other manufacturer related matters.

Specifically, the second Order required that:

- "1. An investigation be conducted of the type certification of the engine-to-wing attachment structure of the McDonnell-Douglas DC-10 series aircraft;

2. To determine whether modification, alteration, maintenance and repair practices and procedures recommended by the manufacturer in the form of Maintenance Manuals, Service Bulletins, or other documents are adequate to assure continued airworthiness of the product pursuant to an Airworthiness Certificate;
3. To determine whether certification practices, procedures and regulations prescribed by the Federal Aviation Administration are adequate to assure the integrity of the engine-to-wing attach structure."

A group of FAA specialists from Headquarters and various regional offices was designated to conduct the McDonnell-Douglas investigation. A fail safe review team from the Western Region Engineering Division was incorporated into the formal investigation.

The formal investigation was divided into 4 teams dealing with different aspects of the investigation. As a result of these investigations, three reports were presented to the Administrator:

1. Presiding Officer's Report to the Administrator on the Investigation of the McDonnell-Douglas Corporation and the Model DC-10 Aircraft, dated July 9, 1979.
2. Report to the Administrator in the Matter of Maintenance and Airworthiness Procedures concerning the DC-10 aircraft, dated June 25, 1979.
3. Report to the Administrator on Investigation of Compliance of the DC-10 Aircraft Leading Edge Outboard Slat with Type Certification Requirements, under Asymmetrical Slat Conditions, dated July 9, 1979.

After review of these reports, and upon consideration of actions taken by the FAA as a result of these investigations, the Administrator found, with respect to those matters investigated, that the Douglas Model DC-10 met the requirements of Section 603(a)(2) of the FAA Act for issuance of a type certificate in that, in such respects, said aircraft is of proper design, material, specification, construction and performance for safe operation and meets the applicable certification criteria of Part 25 of the Federal Aviation Regulations and is eligible for a type certificate.

Accordingly, on July 13, 1979, the Emergency Order of Suspension of Type Certificate A22WE for the McDonnell-Douglas DC-10 aircraft was terminated.

On July 13, 1979, the FAA also issued several AD's which required inspections of various systems and structures. Compliance with the provisions of these AD's was required "before further flight, after the effective date of this AD." The effective date of the amendments or AD's was July 13, 1979.



Amendment 3973515 to AD No. 79-15-05 required modification of the stall warning system, and within 30 days after the effective date of the AD the "slat function of the takeoff warning system must be operative for takeoff." (See appendix F for details.)

One AD, Docket No. AD 79-WE-15-AD, Amendment 39-3514 established inspection cycles and criteria for the leading edge slat system. The AD read, in part:

**ADOPTION OF THE AMENDMENT**

Accordingly, pursuant to the authority delegated to me by the Administrator, Section 39.13 of Part 39 of the Federal Aviation Regulations (14 CFR 39.13) is amended, by adding the following new airworthiness directive:

**MCDONNELL-DOUGLAS:** Applies to Model DC-10-10, -10F, -30, -30F, and -40 aircrafts certificated in all categories,

**Compliance required as indicated.**

To ensure the integrity and condition of the wing leading edge slat mechanical drive system, accomplish the following:

(a) Before further flight, after the effective date of this AD, unless already accomplished after June 6, 1979, and thereafter at intervals not to exceed 600 hours' time in service since the last inspection:

1. Visually inspect all slat system drive cables and pulleys in situ for security, and general condition (corrosion, damage, etc.);

2. Visually inspect all slat system followup cables and pulleys in situ for security and general condition (corrosion, damage, etc.);

3. Visually inspect the inboard and outboard slat drive mechanisms while operating the slat system to verify security of the components and freedom of movement of the mechanisms;

4. Correct all discrepancies found during the above inspections which exceed the condition limitations provided by the McDonnell-Douglas DC-10 Maintenance Manual; and

5. Report results of all inspections to the Chief, Aircraft Engineering Division, FAA Western Region within 24 hours of accomplishment in the following format:

- (1) "N" Number
- (2) Hours time in service at inspection
- (3) Results of inspection by specific paragraph and subparagraph of this AD

- (4) - Part Number
- (5) - Identify contact for follow-up

(b) For #2 and #3 position, slat drive cables, except "zinc coated 7 flex premium cables," before accumulating an additional 1500 hours' time in service on any individual cable after the effective date of this AD, unless a new cable was installed within the last 10,500 hours' time in service, and thereafter at intervals not to exceed 12,000 hours' total time in service on any individual cable, replace the affected drive cable with a new cable of the same part number or an FAA approved replacement cable. If a cable is replaced with a "zinc coated 7 flex premium cable," the cable replacement time limits specified by paragraph (c) become effective for the replacement cable.

(c) For #2 and #3 position; slat "zinc coated 7 flex premium" type drive cables, before accumulating an additional 1500 hours' time in service on any individual cable after the effective date of this AD, unless a new cable was installed within the last 18,500 hours' time in service and thereafter at intervals not to exceed 20,000 hours' total time in service on any individual cable, replace the affected drive cable with a new cable of the same part number of an FAA approved replacement part.

(d) Part numbers of "zinc coated 7 flex premium cables" which are approved replacement cables for compliance with either paragraph (b) or (c) are identified by McDonnell-Douglas All Operators Letter (AOL) 10-1333A, dated October 26, 1978.

(e) The repetitive inspections required by paragraph (a) may be discontinued after the inspections and modifications required by paragraph (b) of AD 78-20-04 (Amendment 39-3308) have been accomplished and after it has been determined that #2 and #3 slat position drive cables are within the 12,000 hours' total time in service, or the 20,000 hours' total time in service limitations of paragraphs (b) or (c) respectively of this AD.

(f) Special flight permits may be issued in accordance with FAR 21.197 and 21.199 to operate aircraft to a base for the accomplishment of inspections required by this AD.

(g) Alternative inspections, modifications or other actions which provide an equivalent level of safety may be used when approved by the Chief, Aircraft Engineering Division, FAA Western Region.

This amendment becomes effective July 13, 1979.

[ Sees. 313(a), 601, and 603, Federal Aviation Act of 1958, as amended (49 U.S.C. 1354(a), 1421, and 1423); Sec. 6(c) Department of Transportation Act (49 U.S.C. 1655(c)); and 14 CFR 11.89 ]

Issued in Washington, D.C. on July 13, 1979.

Director,  
FAA Western Region

An AD was also issued which requires inspections to ensure the integrity of the wing engine pylon structure and ~~attachment on~~ Both wings. The AD reads, in part:

ADOPTION OF THE AMENDMENT

Accordingly, pursuant to the authority delegated to me by the Administrator, Section 39.13 of Part 39 of the Federal Aviation Regulations (14 CFR 39.13) is amended, by adding the following new airworthiness directive:

McDONNELL-DOUGLAS: Applies to Model DC-10-10, -10F, -30, -30F, -40 series aircrafts certificated in all categories.

Compliance required as indicated. To ensure integrity of the wing engine pylon structure and attachment, accomplish the following on both the right and left hand wing:

(a) Prior to further flight, unless already accomplished exactly as specified herein subsequent to June 6, 1979:

1. Prepare the pylon zones to be inspected and accomplish inspections specified in Part 2 of McDonnell-Douglas Alert Service Bulletin, A54-71 stated July 6, 1979, except that the inspections of Alert Service Bulletin A54-71 Part 2, paragraphs K (2), (3), (4), (6) and (7) need not be accomplished if previously accomplished subsequent to May 28, 1979, per AD-79-13-05.

2. Inspect clearance between the wing pylon aft bulkhead attachments and wing aft monoball attach fittings per the accomplishment instructions of McDonnell-Douglas Alert Service Bulletin, 54-70 dated June 15, 1979.

NOTE 1: For the purposes of this AD one flight cycle as referenced in Part 2, paragraph I(4)(b), of ASB 54-71 is defined as one landing. Touch-and-go landings are counted as cycles.

(b) Within 100 hours' time in service after initial inspection required by paragraph (a) of this AD and at intervals not to exceed 100 hours' time in service thereafter:

1. Inspect pylon aft spherical bearing and attaching hardware to verify security of nut and bolt. Inspect torque stripe for alignment.

2. Visually inspect thrust link attachment lugs and attaching thrust link hardware as specified in Part 2, paragraphs K(1) and K(5) of ASB 54-71. Verify alignment of torque stripe.

(c) Within 300 hours' time in service after the initial inspection required by paragraph (a) of this AD and thereafter at intervals not to exceed 600 hours' time in service from the prior inspection:

1. Conduct eddy current inspection of upper surface of pylon aft bulkhead horizontal flange as specified in Part 2, paragraph H of ASB 54-71.

2. Visually inspect wing clevis for cracks and inspect lower wing area surrounding wing clevis for evidence of fuel leaks which may indicate failure of clevis attach bolts.

3. Accomplish inspections specified in Part 2, paragraphs D (1), (2), (3), (4) and (5) of ASB 54-71.

4. Accomplish inspection specified in Part 2, paragraphs E [except (2)] M, O, P and Q of ASB 54-71.

5. Visually inspect upper, forward spherical bearing installation to verify condition, security and torque stripe of plug assembly.

6. Visually inspect the pylon aft, spherical bearing for cracks, without disassembly, using ten power magnification.,

(d) Within 900 hours' time in service after initial inspection required by paragraph (a) of this AD and at intervals not to exceed 600 hours' time in service thereafter ultrasonically inspect exposed surface of pylon attach lug and wing clevis without disassembly per ASB 54-71 Part 2, paragraph D.(6).

(e) Within 1500 hours' time in service after initial inspection required by paragraph (a) of this AD and at intervals not (to) exceed 1500 hours' time in service thereafter:

1. Conduct inspections as specified in Part 2, paragraphs F and G of ASB 54-71.

(f) Within 3000 hours' time in service after initial inspection required by paragraph (a) of this AD and at intervals not to exceed 3000 hours' time in service thereafter:

1. Conduct inspections as specified in Part 2, paragraphs I, K and 'N of ASB 54-71.

2. Conduct inspections per Part 2 of SB 54-70.

(g) Inspect pylon for structural integrity per DC-10 Maintenance Manual TR5-20, dated June 14, 1979, prior to further flight after events producing high pylon loads including but not limited to:

- a. Hard or overweight landings
- b. Severe turbulence encounters
- c. Engine vibration and/or critical failure
- d. Ground damage, (workstands, etc.)
- e. Compressor stalls
- f. Excursions from the runway

(h) General:

1. Correct all discrepancies found as a result of this AD prior to further flight.

2. Damaged or repaired pylon aft bulkheads must be replaced with like serviceable parts prior to further flight.

3. Whenever fasteners are replaced as a result of the inspections specified in ASB 54-71, Part 2, paragraph E, prior to installing new fasteners inspect the holes, and the area around adjacent fasteners (without removing fasteners) for cracks using eddy current or equivalent NDT methods.

(i) After the effective date of this AD, installation of the engine and pylon as an assembly shall render the aircraft unairworthy.

(j) Prior to return to service, after pylon installation accomplish pylon inspection per Part 2, paragraph D(1) through D(5) of ASB 54-71.

(k) Prior to return to service after installation of pylon accomplish inspection of pylon per Part 2, paragraph H of ASB 54-71 and reinspect per Part 2, paragraph H of ASB 54-71 within 300 hours' time in service after initial inspection.

(l) Whenever the pylon has been subjected to vertical and/or horizontal misalignment, inspect per Part 2, paragraph H of ASB 54-71.

(m) After each installation of pylons with titanium upper forward spherical bearing plug; within 300 hours after installation, conduct the following inspection:

1. Partially remove nut from upper spherical bearing through bolt.

2. Inspect plug for failure of the threaded portion from the plug body by vigorously shaking nut (by hand).

3. Remove through bolt and perform a detailed visual inspection of the plug for cracking, by using appropriate optical aids. No cracks or separations are permitted. Reassemble per DC-10 Maintenance Manual.

4. Torque stripe nut to bolt and revert to standard repetitive inspection interval.

(n) Report results of all inspection to the assigned FAA maintenance inspector within 24 hours of accomplishment in the following format:

"N" Number, hours' time in service at inspection, pylon number, results of inspection by specific paragraph and subparagraph of this AD, and Service Bulletins SB 54-70; and ASB 54-71. In reporting be as specific as possible to identify location and size of crack, or specific location of discrepant fastener, etc. List part numbers.

(o) Alternative inspections, modifications or **other actions** which provide equivalent level of safety may be used when approved by the Chief, Aircraft Engineering Division, FAA Western Region.

**NOTE 2** FAA approval of related McDonnell-Douglas Service Bulletin 54-70 has been reinstated,

This supersedes Amendment **39-3505 (44FR37617)**, AD 79-13-05.

This amendment becomes effective July 13, 1979.

[Secs. 313(a), 601, and 603, Federal Aviation Act of 1958, as amended (49 U.S.C. 1354(a), 1421, and 1423); Sec. 6(c) Department of Transportation Act (49 U.S.C. 1655(c)); and 14 CFR 11.891

Issued in Washington, D.C. on July 13, 1979.

Director,  
FAA Western Region

AMERICAN AIRLINES DC-10, FLIGHT 191

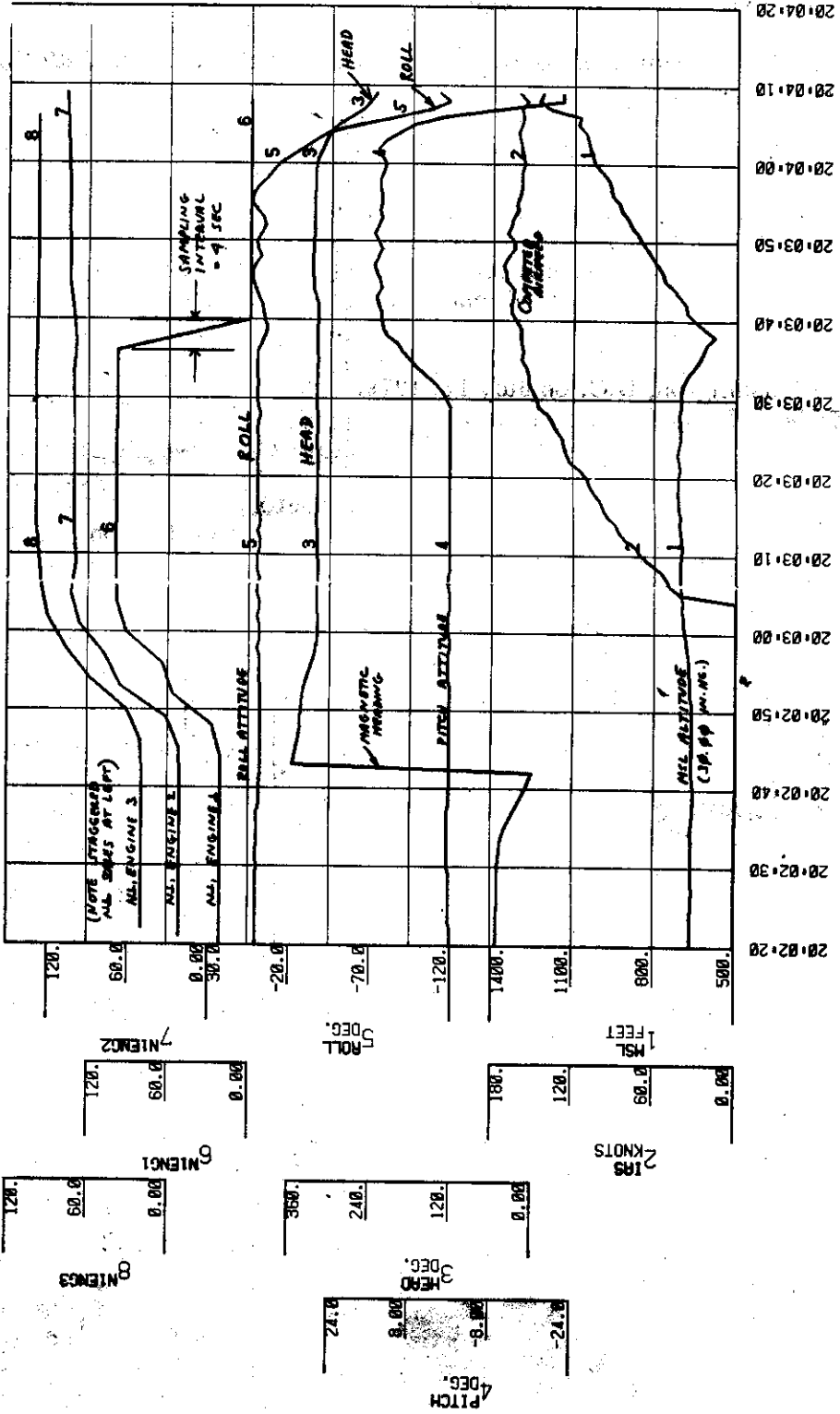

HH:MM:SS  
GREENWICH MEAN TIME