

## THE ADVANCE KNIFE MAKERS MANUAL



### THE ADVANCE KNIFE MAKERS MANUAL

Copyright (c) 2000 Harold Hoffman

If you want to learn how to make custom knives, folding knives, spring back knives, knife repair, lock back knives, fix blades, knife, knives, this book has all the information that you will need. It is an excellent book for the beginner or advanced craft person.

This manual shows you how to make all different types of custom knives, folding, spring backs, fix, Damascus knives, knife blades, or learn how to repair all types of knives. This book covers grinders, rigid, lock backs, blades, fix blades, fix blades, sharpening grinders, and nickel-plating knives. This book has hundreds of drawings, and photos that you can follow step-by-step as you make your first knife.

All rights reserved. No parts of this publication may be reproduced or transmitted in any form or by any means, electronic or mechanical, including photocopy, recording, or any information storage and retrieval system, without the written consent of the publisher.

Action Books  
7174 Hoffman Rd.  
San Angelo, TX. 76905  
Phone/Fax 915-655-5953  
[Home Site](#)

# Zaibatsu Release

I am the alpha, the omega,  
the beginning and the end

# THE ADVANCE KNIFE MAKERS MANUAL



## ABOUT THE AUTHOR

Harold Hoffman has through his 30 plus years of experience as a Gunsmith, Toolmaker and Custom Knife maker has passed on to you through his books information that soon may be lost or forgotten. His books are not intended for the person wanting to make a complete firearm, but for learning basic shop tool making. The information found within his books is for instructional purpose only. -- The titles DO NOT actual cover gun repair on firearms, but how to make needed parts for firearms which is about 40% of all gun repair. Without this information you will be severely limited in gun repair.

He first started gun repair when he was 18 years old doing minor repair for the farmers and local hunters in the Bucklin, Kansas area. His main interest was how to make rifle barrels, as he was an avid hunter. Moving into a bigger shop he bought a lathe and proceeded to learn how to use it.

He wanted to find out how to make rifling buttons to rifle barrels, tool making, and learn everything about making barrels. Over the years he became an expert toolmaker and how to build most everything that was needed in the shop. The information found in his books will show you how to make most of the equipment and tools needed in most shops.

After an eye accident he quit Gunsmithing and started writing books on everything that he knew. He had so much difficulty finding any information that he wanted all this information that he had learned in over 30 years to be available to everyone otherwise it would be lost.

His books are now about the only books available on Gunsmithing/Tool making, as most publishers do not publish Gun or Gunsmithing books anymore.

# THE ADVANCE KNIFE MAKERS MANUAL

## ABOUT MAKING KNIVES

If you want to learn how to make custom knives, folding knives, spring back knives, spring back, lock backs, knife making books, making folding knives, knife repair, lock back knives, making knives, knife making, fix blades, knife, knives, this book has all the information that you will need. It is an excellent book for the beginner or advanced craft person.

This manual shows you how to make all different types of custom knives, folding, spring backs, fix, Damascus knives, knife blades, or learn how to repair all types of knives. This book covers grinders, rigid, lock backs, blades, fix blades, fix blades, sharpening grinders, and nickel-plating knives. This book has hundreds of drawings, and photos that you can follow step-by-step as you make your first knife.

All rights reserved. No parts of this publication may be reproduced or transmitted in any form or by any means, electronic or mechanical, including photocopy, recording, or any information storage and retrieval system, without the written consent of the publisher.

# THE ADVANCE KNIFE MAKERS MANUAL

## PREFACE

Make your own knife? Now, that may sound strange to most people. Why would you want to do this, when there are so many low price and attractive knives for sale?

Many people have asked me this many times. Most people are satisfied with a small knife that they can carry in their pocket. They use it to clean their fingernails, open envelopes, etc. Others want a hunting knife that they can pry or pound on in splitting out game. If they lose it, so what, it did not cost much.

The small majority of people look at a knife as a very important tool, one to take care of, and not to be without. These people want a knife that will last a long time, or a lifetime. They also want a knife that will hold an edge, and sharpens easily.

Most people that make knives, or thinking about making knives, are not satisfied with the knives that are available. Making their own is one way to get what they want.

This book is about making fix blades, folders, spring backs and Lock backs. I will show the reader how to make these knives in this book, as well as many other processes that will be useful as well as save you much time. I also go into the advance phase of the Knife Makers art that includes casting of special parts and fittings. This will allow a higher profit margin on duplicated knives.

I will show the reader how to make one or a dozen knives, using patterns or templates. This method eliminates hours of work on the knife. After making a dozen or more knives, you can expect to be able to make a first class folder in eight hours or less.

The equipment needed is not that expensive, and most people that like to make things will have some of the equipment that I will describe in the next chapter.

Each knife that you build can be a beauty, and a work of art. It will surprise you of the beauty and the uniqueness of the knives you build. They are sleek and graceful, and you can build each with your personal touch.

I do not normally go into the making of fix blade knives, but the casting of special parts will be valuable to you in this area. I made most of my knives as fix blades for more than forty years. I started make folders about five years ago and from that time on have made nothing but folders. Folders are for me much easier than ridged knives, and more useful.

Do not let other knife makers discourage you from making folders? Many that I have met have told me they tried to make one and it took twice as long to make as a fix blade. They are right. If you try to make a folder, using the same methods as making a fix blade, it will take a long time.



## THE ADVANCE KNIFE MAKERS MANUAL

The secret is as stated above is the template. I make the template from 1/16 tool steel, fitted as you would a regular knife, and heat-treated. Once this is done, I just take minutes to fit a knife. Without this template, it would take hours.

Many processes discussed in this book are basic machine shop practices, but do apply to the knife maker.

Another advantage in making your own knife is that you can select steel that will meet your requirements. After heat-treating the blade, you can draw the blade (temper) to meet your requirements.

This book will give you all the basic instructions that you will need. It will also tell you how to make some tools that you need in the shop.

Harold Hoffman

# THE ADVANCE KNIFE MAKERS MANUAL

## EQUIPMENT NEEDED

So you are serious about getting started making knives. There are some knife makers that I know that started with a hacksaw and an electric grinder. These were the hard nose knife makers, who gathered up some old files and ground them into first class knives.

I have made several knives this way, with good results, but this is the hard way. You have to be very determined or you soon lose interest in making knives this way.

## DRILL PRESS

If you want to start off right, one of the first piece of equipment that you will need is a drill press. The drill press can be a table or one that is on its own stand. I prefer the one that is on its own stand, as it can be set Just about any place.

The drill press is one of the most often used tools in the knife repair shop. It is designed to cut round holes into or through materials. They come both in bench and floor models, It is referred to as sensitive because you can "feel" the cut and feed of the cutting tool into the work piece. This "feel is due to the balance of the spindle. Drill presses come in a variety of sizes. Sizes are determined and rated by the distance from the center of the spindle to the outside diameter of the support column. For the average shop, a 14" press is suitable.

A drill press vise is almost mandatory, and a rotary c cross-feed table is desirable. Quite a few tools may be used in the drill press including: the twist drill, reamers, Router bit, rotary files, counter bores, countersinks, and grinder cups. A good heavy duty drill press can also double as a light duty mill by utilizing the cross-feed table and various end mills.

I use a Sears craftsman drill press. They have as good a model as any, and what is more important is that you will always be able to find parts for it if it breaks down. Also Sears carries quite a few accessory items that can be added to it. If you buy the heavier model, you can get a milling vice that will bolt on the table. This will let you turn the drill press into a light milling machine. In most cases you will never need this option. Certainly get one that has quite a few speed settings.

Another handy item is a vise. You cannot appreciate how important it is until you are holding an object with your fingers, and have it jerked from your grip.

Usually what, happens is that, (1)you cuss, (2)you shut off the machine, and(3)you head for the first aid kit, dripping blood all over the floor.

## DRILL & WIRE GAGE

A drill and wire gage are very much needed. With several small drills lying around it is very

# THE ADVANCE KNIFE MAKERS MANUAL

hard to tell a .082 from a .086. Also it is the best way to check pin size without a micrometer.

## DRILLS

A series of number drill sizes that range from 1/8" on down is also needed. The following sizes will take care of about all of your pin sizes. .125, .092, .086, .082, .073, .063, .054.

You will also need a box of numbered drill bits, as well as the standard decimal size. The numbered bits are the main ones that I use in knife making. The nickel silver rod and wire that is used to pin the knives, are never the same size, so you have to drill to suit.

A small metal countersink should complete the hardware necessary for the drill press.

## CUTLER'S ANVIL

The anvil is nothing more than a cutler's anvil. This tool along with the hammer will be the most small tool used in making or repairing knives.

This anvil is used by the cutler for many things as well as a small anvil. It is on the anvil that pin holding blades are peened. The slot on the thick end of the anvil is used to insert a blade while adjusting it so it will not strike other blades when closing.

The surface is flat with a step down at the front. A hole is at the rear for driving pins out of the bolsters and scales. A slot is at the front for grasping and pulling pins. The thin lip is used for tightening rivets in an assembled knife.

The thin portion of the anvil can be used to reach into a knife so that a cover pin may be peened. This is an item that will have to be made by your local machine

The knife is slid upon the lip with the blades open. This will give support to the back of the rivet while you peen the top of the rivet.

The anvil should be made from a good grade of tool steel and hardened to about 45 Rc. The hole at the rear should be drilled approximately 5/16 ". The slot can be cut out with the cut off wheel of your drymel-tool or a band saw and then filed. Be sure to have holes for bolting the anvil to a good firm table.

An anvil of some sort is needed on the work bench. When you peen the blades in the knife it is set on the anvil. The knife maker's anvil is a handy item also. It will allow you to put new pins in the handle without taking the knife apart.

## WISE

# THE ADVANCE KNIFE MAKERS MANUAL

Every repairman will need a vise here is no substitute for it. Vises come in a variety of styles and sizes and there is no such thing as one that will suit all needs. Foremost is the vise used in assembling the knife. I strongly recommend using brass jaws.

I do not believe the brass jaws are available for this vise, so they will have to be fabricated in the shop. Other vises to consider are the drill press vise and a large general purpose vise for rough work.

Any good 4" or 6" vise can be used. Be sure to get one with removable jaws. These jaws will have to be ground smooth to prevent damage to your knife while you have it in the vise.

## **BELT SANDERS**

I use the Sears 6 by 48 inch belt sander, as well as a smaller 4 by 36 model. I consider these belt sanders to be one of the most important pieces of equipment in the shop. They have a round disk sander that I use to cut 45 degree angles on my bolsters. On the bigger sander it uses a 9-inch disk.

You can get three different grits of belts from Sears, but I get most of my belts from WHOLESALE TOOLS, as they have over 10 different grits to choose from. If you buy in quantity, the cost goes down quite a bit. You will need grits from 36 to 220. You will find that the belt sander will be the main tool to give you the very close fit that you will be going for.

## **DISC SANDERS**

A standard 9" table disc sander will enable you to sand all of your handle material to a good flat surface. I would also suggest mounting a piece of flat bar stock on the table to act as a guide and will also help hold your work. Disc sanders also can act as a saw to the ends of your handle material. It will grind them to a good straight edge. This is very important when you are hand-fitting handles or cover scales.

## **BENCH GRINDERS**

A shop just cannot run without a good one. Bench grinders start at 1/4 hp and go up. A good compromise is a 1/2 hp grinder that will normally carry two wheels of stone. As a rule, one wheel is coarse and one fine. These wheels are man made and have limitations. Observe the rpm maximum on these wheels.

## **SHOP BUILT BUFFER**

To do the grinding on the back springs, blades, and cover scales you will need a belt grinder or drum sander. Belt grinders are the heart beat of the cutlery industry, They can cut faster and give a better finish than any emery wheel. Also they are much safer.

# THE ADVANCE KNIFE MAKERS MANUAL

Before installing new wheels on a grinder, check for cracks in the wheel. One way to safety check this is to insert a rod into the arbor hole and lightly strike the wheel with a metal rod. The wheel should have a slight ringing sound: beware if there is a dull thud. I use a 1/4 hp unit to hone knives. One side holds a fine grit stone while the other side holds a 4" felt wheel with emery.

The fine stone will do a good job of putting a factory edge on a blade and the felt wheel will finish it off to a razor edge. As a rule, grinders will turn 3450 rpm.

Several companies make belt grinders, but for all practical purposes one that uses a 2" x 48" belt will serve all of your needs. The grit you can choose from will range from 60 to 700. The finer grit belts work very well when trying to remove deep pits in blades.

One more word of advice, make sure your belt grinder has a rubber contact wheel. This is what gives the uniform finish on your blades.

## **BAND SAWS**

You will need a good metal cutting band saw. The band saw will be used more than just about any piece of equipment, with the exception of the blade grinder.

Band Saws come both in table and floor models. In knife repair, as well as knife making, you will find the band saw an indispensable item. It will serve to cut bone, stag, wood, micarta, blank out a back spring or blade, and make brass liners or guards. Many hours of sweat will be saved by the band saw.

A 12" or 14" band saw is very handy around the shop. For sawing handle material or for cutting a piece of steel they are quite useful. The band saw can be used to trim excess handle material on scales and save much sanding on the disc sander or belt grinder. The best all around blade size to use is 1/4" width with a pitch of 14 teeth per inch.

There are quite a few saws in the market place, although the checkbook will be one of the deciding factors in the purchase of a saw. This is a once in a lifetime purchase and lower price isn't always good and good isn't usually lower price!

The band saw will need to have a speed reducer on it to reduce the speed for cutting metal. If you buy a Sears band saw they sell speed reducers for cutting metal. Use 14-18 tooth blades for metal cutting.

## **KNIFE GRINDER**

The next piece of equipment that is necessary is a knife grinder. I have looked over several, and have two. A belt grinder is a most useful tool in the shop. Depending on the grits used, the machine can be used for heavy stock removal all the way through polishing. The Olympic

# THE ADVANCE KNIFE MAKERS MANUAL

Square Wheel unit marketed by Wilton Corporation and is one of the most versatile machines available. It will grind concave surfaces as well as flat surfaces. Attachments are available so that one may grind as small a radius as 3/16" or as large as 5'. Another very useful machine is the Grinder or Finishing machine. Abrasive belts are available through the full range of grits, from extra coarse through extra fine. Butt joint belts seem to work better than lap joint belts.

You can get quite a few accessories for it, which makes it a very handy and fast machine. It uses a 2 by 72 inch belt, and comes in grits from 36 to 600. Normally an assortment from 36 to 320 is all that is necessary to make knives. I only use to grind the blades and radius the handles. It will be a scary piece of equipment to use as first, as it runs very fast. Always wear some type of protective eye shield when using the grinders. The belts have a way of flying apart at the most inconvenient time.

When grinding or buffing always wear safety glasses. Grinding is the act of shaping, dressing, or finishing material on an abrasive surface. You will note that the quality of the work you do will depend on the handling, movement, and speed in which you grind.

## MILLING MACHINE

To become proficient in grinding takes practice. Use an old piece of bar stock to grind on to obtain the feel and touch of grinding. You will learn that hard fast grinding causes the metal to heat up and possibly draw the temper. Allow a certain amount of time between each pass so that the metal will stay cool. You can even keep a pan of water close by to submerge the work piece to make sure it does stay cool.

The Wilton grinder is used to hollow grind the blades. It can be used to flat grind also. In flat grinding blades, I prefer to rough it off with the Wilton, then finish on the flat sanders.

## BALDOR BUFFER

Do not worry about grinding a knife blade. This is how they are shaped at the factories. The blades are blanked out, tempered, and then wet ground. If you should have a blade that has "mooned" out in the center, you can shape this blade to a good straight surface by grinding it down from the bottom of the edge.

Rust pits and scratches can be removed by grinding. Start with a 240 grit belt and work your way down to a 500 or 600 grit. Always be careful and not press too hard with the coarser grits or you will remove more surface than you intend to.

## MILLING MACHINE

This is not a necessary piece of equipment for knife making. I included it in case you have one, or can get one reasonable. If I have my choice of the drill press or milling machine, I

# THE ADVANCE KNIFE MAKERS MANUAL

would take the Milling machine. It will do everything.

## SHAPER

I use a shaper to remove excess metal from knife stock. What it will do, the milling machine will do better. It does come in handy to remove metal, while you do other things. Again this is not a necessary piece of equipment.

## LATHE

A lathe is not used to much in knife making. Where I use it the most is making special size pins, for metric knives. At times you have to make up special tools, and this is where it comes in handy. It is not necessary to have it.

## BUFFERS

A good buffing wheel is also necessary. You can use a metal grinder to make a good buffer. If you have any old electric motors, you can get a mandrel that will make up an excellent buffer.

Buffing machines are one of the most used pieces of machinery in the shop. It is impossible to repair knives without it. Buffers come in sizes from small fractional horsepower units for jewelers to 10 hp units for buffing auto bumpers. Usually, a 1/4 hp buffer equipped with 6" to 8" wheels will be satisfactory for the home hobbyist who wants to remove tarnish and shine his knives. This size will remove light rust and scratches. If you are looking for a machine for commercial use, I would recommend no less than a 1 hp unit. Of course, even the large shop will encounter needs for a smaller unit.

I have used the Baldor units in my shop for years under constant use and can recommend them. A pedestal model is available as well as dust removal options. Buffers come in two speeds: 1725 rpm and 3450 rpm. Some shops prefer 3450 and one commercial cutlery uses 2800 rpm.

Rpm is not really as important as surface per minute is what determines the finish. Rpm is how many feet of wheel passes a given point in a minute. In other words, a 10" wheel on a 1725 rpm unit does the same work as a 5" wheel on a 3450 unit. Homemade units are also a possibility, and are quite easy to build. Although not as nice to look at, nor as compact as a commercial unit, it will do a good job. The primary product of a buffer is dust. Blade polishing seems to be secondary. A good vacuum system is highly recommended.

There are commercial type buffers you can buy or you make one with a line shaft, pulleys, pillow blocks, and an old motor. The ends of the line shaft will have to be threaded for locking

# THE ADVANCE KNIFE MAKERS MANUAL

nuts. One advantage to this system is by placing a set of step pulleys on the line shaft and motor you can have a different speed selection. The main speeds for buffing using 6" or 8" wheels are 1750 RPM and 3600 RPM.

Buffing or polishing is for the most part the final act on repairing or building a knife. There are many different systems and rarely will you find two alike. Some will consist of a high speed with 90 ply muslin or felt wheels while others will have a slow speed with loose 20 ply stacked muslin wheels.

## **BUFFING WHEELS**

You will need at least 2 Buffing wheels. I like the eight inch size. You will need one loose buff to do the final finish on the handles. Use a full disc sewed buff for using a coarser grit, to remove the scratches from the metal.

Grease wheels are used in the cutlery industry in finishing blades and preparing them for polishing. Most all manufacturers have now discontinued them for the silicon carbide impregnated nylon wheels. The nylon wheels are very expensive and will not cut any better than the grease wheels. The only advantage is they do not have to be "charged" or coated as often.

A grease wheel is a hard muslin buff 70-90 ply sewn and glued together. The face was coated with hide glue and then the wheel was rolled in a pan of Turkish emery (depending on the size grit desired) and then baked. After the wheel was placed back on the spindle a shaping stone was used to knock off all high points. A light coating of grease was also applied to the surface to give a smoother cut. Now we use special buffing compounds that replaces the grease wheels.

## **BUFFING COMPOUND**

You will need a good assortment of buffing compound, from 180 grit to 400 grit. Most of these can be purchase from knife suppliers. I however finish out my blades with 320 grit on the Wilton grinder, then bead blast them. The reason for bead blasting the blades is that after going over them with a fine wire wheel I have a finish that holds up. The wire wheel takes the roughness off the bead blast finish, and puts a satin finish on the blade. It is a very attractive finish, and holds up well.

## **BEAD BLASTERS**

If you want to use a bead blasters to get a satin finish on your knives, I am sure you be pleased with it. The bead blasters can be purchase from Machine Supply Houses. A large amount of the knives that I make is used by Ranchers, Farmer, Hunters, and people who used the knife on an everyday basis. I had been using a High Polish Finish on the blades.



# THE ADVANCE KNIFE MAKERS MANUAL

After about 6 months the blades were all scratch up from use. My knife had a Satin Finish on it and it to and was well used. It, however was no scratch up from use.

## HEAT TREATING FURNACE

Over the years I have used quite a few different types of heat treating furnaces. Electric is by far the best for average use. If you are using Stain less Steel it is almost a necessity, I you can not read the temperature by color. If you are using O1 tool steel to make the blades, a gas heating furnace works fine. In a later Chapter I will show you how to make one.

## BRAZING FLUX

I heat treat all of my knives in a gas blast furnace. To protect the blades from decarbonizing, I use brazing flux as a coating to keep this from happening. This totally protects the metal from burning.

## ACETYLENE TORCH

An acetylene torch is nice to have, as there are usually quite a few small parts that will need heat treating. It is not a necessary item though. A butane torch works good also, but the heat is limited. It works good for drawing small parts.

## HAMMERS

The hammer is one of the most important tools that the cutler possesses. The hammer is an extension of the knife maker's hand and mind. The 7 oz. tinner's hammer. It is of the cross peen type.

## SCRIBE FOR MARKING LAYOUTS

In addition to the tinner's hammer, a selection of ball peen hammers plus a light brass hammer is needed. A 7 oz. ball peen hammer is better for most work. A cutler's hammer is similar to the above, but it is like a cross peen hammer. These hammers are useful in peening bolsters, blades, and springs.

These hammers do a good job of riveting, crink in blades, and stretching run ups, kicks and back springs.

The second hammer can also be a regular 7 oz. tack hammer. With your cut off wheel on your Dremel tool, cut cross lines on the face of the hammer. The tiny square boxes will have a cutting affect on the surface that it will strike. This type hammer is often called a cut face

# THE ADVANCE KNIFE MAKERS MANUAL

hammer.

## SCRIBE

This tool is used in layout to mark materials. In a sense it is really a pencil used to scratch a line. There are many on the market from plain to fancy. I use a mechanical drafting pencil with a #40 sharpened drill instead of lead.

## DREMEL-TOOL

A drymel-tool or heavy-duty valve grinder is also an important tool used in knife repair. A speed control unit is also needed when used with the drymel-tool. This unit can be used to cut, grind, and drill. Different size collets come with this tool. By using different size collets you can use drill sizes from .125 down to .040. This tool will give you better control on drilling small holes, even more than a drill press.

## BURRS

Burrs are very handy when used with the flexible shaft tool. They can be used to accomplish a variety of cutting and shaping chores. They are especially useful in jiggling bone and cleaning up solder seams.

## PUNCHES

To remove pins after they are sheared, you must have an assortment of punches. You will need a set of small pin punches. The punches illustrated are to remove blade pins from bolsters. This punch was modified to suit my purpose. The drawing shows the proper style punches to remove pins from covers and shields. Standard 1/8" pin punches from local hardware store can be made into a good set of pin punches.

To make the correct size you need grind these punches down on your belt or drum sander. Always use your drill gage to check the correct thickness.

Surplus stores carry broken punches that are fine for regrinding into special shapes, or you may want to fabricate your own. 0-1 steel makes a dandy punch.

Also be sure to not allow the punch to become too hot or it may draw the temper from the steel. Grind a set of punches for the following sizes: .080, .070, .060, and .050. On one punch grind a blunt end as a center punch. They are useful in starting to drive or locate pins in bolsters.

## FILES

Every workbench should have a good selection of files. A good start would be: an 8" second

# THE ADVANCE KNIFE MAKERS MANUAL

cut flat file, an 8" second cut half round, an 8" smooth cut, and a set of jewelers'

## SCREWDRIVERS

Although not especially pertinent to knife repair, every shop requires screwdrivers, so a good set is a wise investment.

## DIAGONAL CUTTERS

Don't waste money on a cheap pair of dikes. A good pair will be worth the difference in price. Some cutler's like the regular cut, but I prefer the flush cut. One has to be careful with the flush cut since it will dull or chip more readily, but I do like the nice square cut it makes. Never cut hardened metals with diagonals.

A standard pair of end flippers is also a very handy tool. You can pick SIDE CUTTING DIKES up, a pair of these pliers at your local hardware store. There is one modification you will need to make. The face needs to be ground down flush with the lips. This will enable you to cut pins much closer and gives you more ease in grasping pins and rivets.

## WISE-GRIPS

Vise-grips are handy to use while grinding and polishing single blades and springs. When a blade or spring is not in an assembled knife, vise grips will be a useful tool for holding these parts while you work on them.

## MEASURING TOOLS

Every shop should have a good pair of 1" micrometers 6" steel rule, combination square, drill gauge, and wire gauges. Special care should be taken of your measuring tools by never leaving them lying around. Have a proper location for them and return them to that location after each use. Keep dirt or grime from them.

## LAY UP

A good set of Dial Calipers is a necessity. A 0-1 inch Micrometers will do the same job, but a 6 or 8 inch Caliper is handier. When you start fitting the knives together, you have to know what the measurements are on each part. If you don't, you will either have a sloppy or a sticky knife.

## GRINDERS

# THE ADVANCE KNIFE MAKERS MANUAL

A good bench grinder is needed to sharpen dull drill bits. You can however do a good job of sharpening the bits on a belt grinder. A Hand Held Grinder like a Dremel is very handy for fitting and finishing in small places. You can get many accessories for it, to help make your job easier.

## HAND TOOLS

Files are the main tool that you will use. Just about all the fitting will involve the file. You will need files from 6" to 12". Also a good set of

needle files will be needed to finish sharp or narrow parts. They are also used in the file work on the back of the knife. This is artwork, and is used to decorate the finish knife.

You will need a couple of small Ball Peen Hammers. Get the smallest size that you can find. They are used to peen the pins in the knife. You will need a slightly larger one for use in stamping the nail notch in the blade (This is a piece of Tool Steel shaped like the nail notch. It is used to swedge the nail notch in the blade).

## WIRE NIPPERS

A good set of wire nippers is also necessary. These will be used to clip the pins off that are used to hold the knife together. The end nippers are by far the best, though side nippers will work just about as good.

## DYKEM LAYOUT DYE

This is used to coat the steel so you can mark out the pattern of the knife. **.025 SHIM STOCK TAPERED 10.005** for cutting out.

## SHARPENING GRINDERS

This is the standard tool grinder. The stones are removed and card board wheels are put on in place of the stones. When the knife is completely done, you use the belt grinder to rough shape the cutting edge.

You then go to the cardboard wheels to finish the sharpening. One wheel is coated with fine carbide powder, is use to put a fine burr on the cutting edge. The other wheel is coated whit a fine buffing compound. This removes the burr, and puts a razor sharp edge to the knife.

# THE ADVANCE KNIFE MAKERS MANUAL

## SLACKING TOOL

The slacking tool is used as a spacer when the knife is being assembled. This item, can be purchased, but I usually make them in the shop. It is used to insert between the blade and scale or liner while peening blade pins. It will give the proper clearance to allow the blade to work smoothly, but not too loose.

There must be a certain amount of play between the blade and the bolster scales. If there is not, the bolster scales will act as a brake and not allow the blade to move freely. To have a good tight fit and be able topeen the pins tightly in the bolster holes I use a slacking tool to allow the right amount of slack between the blade and bolster scales.

## CRINKING BLOCK

The slacking tool is easy to make. Cut a piece of shim stock about .010 to .015 in thickness. This should be about 1/2" wide and 3" long. With your cut off wheel of your drymel-tool cut a slot or notch 3/16" wide and deep. This will allow you to slide this tool between and bolster scale while the slot will pass over the pin.

A crinking block is used for crinking or bending blades. The block is used on the anvil to rest the blade. The high or low side of the block is used according to which side of the knife the blade you are going to crink is on. This will keep your blade up level with the bolster. With the blunt end of your cutler's hammer, strike the blade directly on the long stamp area. Always check the hardness with a file before trying to crink a blade. This will cause the blade to bend upwards.

**CAUTION** -Some blades are tempered too hard and may have to be annealed slightly past the tang or they may break.

I make my crinking blocks from a piece of key stock. You will need a different size block for the different size knives you will be working on. I use stock 1/2" wide and 1 1/2" long to make them. Grind one side down. This will give you a high and low side.

## SPINNERS

While not actually a hand tool, it is also not a power tool. It is used to obtain that nice round head on cover pint and the back spring pin. This would be more for burnishing than for cutting tools. Several sizes will be used according to the size pin to be spun. These can be purchased from knife supply houses.

This is the tool that spins the head on pins and rivets. You use two for spinning, one is placed in the chuck of a drill press with the other being stationary in a vise. The center pin or rivet in a newly constructed knife is placed between these spinners.

## THE ADVANCE KNIFE MAKERS MANUAL

After the top side is spun, the knife is turned over and the other end of the pin is spun. They will form a nice round head to hold the pin and cover scales securely.

I make them from drill rod and turn them in a lathe. The cutting cavity is drilled from a 1/8" drill. It can either have a slot inside or ground to an angle for a cutting surface.

### SPREADER

The spreader does exactly as it says. It spreads the blades apart. During assembly if the front of the knife becomes too tight this will cause the blades to strike each other. It is also used to "level" the knife, meaning the distance of the back side from scale to scale is the same as it is at the front.

I make mine from a 1/4" piece of round brass stock and grind a taper on the end for different types of knives.

### NICKEL PLATING

On the blades that I use 01 tool steel, I use a product called Marine Tuff. This is very similar to Nickel plating. 01 tool steel rusts very easily, but as a knife blade material it is hard to beat. Marine Tuff eliminates the rusting problem, and puts a very thin coating similar to Nickel Plating (See chapter on Nickel Plating). It is almost as hard and wear resistant as carbide. Electroless Nickel Plating works almost as good. This is not new, as some of the well known knife manufactures had started using this many years ago.

There will be many other items that you will need as you go on. In the Appendix you will find the names and address of suppliers where you can get all the supplies you will need.

# THE ADVANCE KNIFE MAKERS MANUAL

## HANDLE MATERIAL FOR KNIVES

The best part of any knife is the handle. Just about all types of materials have been used, from jade to wood. We will look at the most common materials used in the cutlery industry.

To fit a handle to a bolster scale, the backside must be flat, and this is done on the disc sander. After the backside is flat, turn the handle to so you can grind the ends to fit against the bolsters. At this stage, it is a good idea to go ahead and rivet the handle to the bolster scale.

### MICARTA

Impregnating wood laminate, linen, or paper with a phenolic resin makes Micarta, and it takes much abuse, works well with sanders and routers, and buffs to a high luster.

Bone, or ivory colored Micarta is more difficult to work with; it usually contains tiny imperfections that can mar the finished handle. Just about the time you think you have got your handle polished to perfection, a black speck or two will appear, and back to the emery cloth you must go. It also will turn yellowish under high speed buffing.

Micarta comes in several colors, and these varieties have tiny imperfections too, but because of their darker color, the specks are not as visible.

### DELRIN

Delrin or composition handles are by far the easiest with which to work. This material is very durable and will polish to a high gloss. Be careful and not use a fast speed on the buffer.

### CELLULOID

They introduced Celluloid's years ago as handle material, and the majority of the cutlery manufactures used it. Celluloid makes a unique handle that can give a Christmas tree or Waterfall look. There is one major problem with celluloid. The flash point of this substance is very low. When grinding celluloid, be extremely careful for it will ignite anytime after it gets hot. When buffing, be sure to note that it will burn or blur very quickly at a high speed. Use a slow speed with a light amount of pressure.

# THE ADVANCE KNIFE MAKERS MANUAL

## EXOTIC WOODS

### AFRICAN BLACK WOOD

An exceptionally dense, very hard wood that works well, and needs no finish. It is as dark as ebony and extremely fine-grained and dense. Polished, it takes a deep satin finish, and it does not split like ebony. Sad to say, it is in short supply and about twice as expensive as most other exotic's. It is a rich dark brown with contrasting tan to set off the figure. Weighs 82 lbs. per cubic foot.

### ANGILO

It is also known as Mesua, Indian Rose Chestnut, and Ironwood in India. It is found in India, Burma, Ceylon, and the Andaman Islands. It is very hard and heavy. It has a very distinct grain pattern, no matter which way they cut it. Close stripe if quarter sawed and an open wavy pattern, if sliced. The colors range from tan to brown when freshly cut and turns to reddish brown after exposure, it works easily with sharp tools and finishes well. Weighs 65 lbs. per cubic foot.

### ARIZONA IRONWOOD

It is a rich, golden brown wood with strong chocolate brown to black figures, and it is very heavy, hard, and oily and finishes to a smooth satin finish. It makes a beautiful presentation knife when paired with gold or brass hardware. Weighs 68 lbs. per cubic foot.

### BLACK PALM

This is the outer casing of the Black Palm tree. The wood is made up of bonded round fibers. The color is dramatic black with gold streaks appearing frequently but on a random basis. Sealing it is necessary for this wood because of its structure. Black Palm is native to Central and South America.

### BLOOD WOOD

This brilliantly colored wood and, as the name implies, is a rich deep red with undertones of purple, but very little figure. It is not as dense and heavy as other woods, but is free from warping and shrinkage. Weighs 60 lbs. per cubic foot.

### BOCOTE

It is also known as Mayan Rosewood, Canalete, and Cordia, is a hard, heavy, strong wood full of exotic figures. This African import has alternating bands of yellow and brown, interspersed with narrower stripes of black. It takes a good luster on buffing, but tends to



# THE ADVANCE KNIFE MAKERS MANUAL

darken with age. It is resinous and does not require oiling.

No two pieces are the same. The figure runs from a bird's-eye, to flowered heart, to stripe. The color ranges from red brown to gray brown, and gold with pronounced dark closed grain. Weighs 55 lbs. per cubic foot.

## **COCOBOLO**

One of the most colorful woods available; it varies from red to black, gold, and yellow. They import it from Panama, Costa Rica and Nicaragua. This wood is fine-grained and very durable; this wood is a favorite of knife makers and pistol smiths alike. Smith & Wesson uses it for their magnum grips on their pistols. Lighter in color than rosewood, it has streaks running from dark brown to black throughout. We can oil it, but takes nice semis lustrous finish without it.

The dust resulting from sawing and sanding is hazardous to those who are allergic to it. A good mask should be worn while processing the wood. Despite this problem, it is one of the all time favorites for knife handles because of its beauty and durability. Weighs 60 to 77 lbs. per cubic foot.

## **DIFLOU**

Usually called golden pheasant in the trade, and it has a pale golden color and a nice firm grain. It is extremely hard and takes a beautiful finish. Scorching with a propane torch can obtain an unusual effect to get alternating bands of reddish bronze color, and it is hard to work with, but worth the effort.

## **EBONY**

This wood exists in many varieties, varying from black (from Gabon, Central West Africa, and Ceylon) to black streaked with yellow and yellowish brown (from East India). It is an extremely dark, fine-grained wood used for knife making for more than a century. It polishes well without oiling or other finish, but its propensity for splitting makes it difficult to work with and less than desirable in a finished handle. All ebony is hard and dense, and, therefore, is durable and takes a very fine polish. Weighs 5075 lbs. per cubic foot.

## **GONCOLO ALVES**

This is a wood of moderate density, works easily, and takes a high polish. Its color ranges from light to dark brown, sometimes reddish, exhibiting vertical bands or stripes of black. You have seen it on Smith & Wesson handguns. It comes from Southern Mexico to tropical South America but the primary source is eastern Brazil. Weighs 53 lbs. per cubic foot.

## **KING WOOD**

## THE ADVANCE KNIFE MAKERS MANUAL

This is a dense, hard wood with blue to purple figure, either a highly figured pattern or closely spaced lines, depending upon the way they cut it. They import this wood from Mexico. Weighs 75 lbs. per cubic foot.

### LAPACHO

This South American import is about the color of walnut and almost without figure. It works extremely well, and is a good choice if you plan to score or checker your handle. It buffs well and requires no filler, but an oil finish will add to its luster.

### LIGNUM VITAE

They also call this wood Guayacan and Guaiacum. It is the hardest and densest of all the woods. The color varies somewhat from piece to piece. It is brown, oxidizing to a greenish brown or almost black. Another South American import, this is so dense it refuses to float. It has a straight yellow and brown striped figure and buffs to a high gloss. Working with it is hard, (use a sharp drill bit) but it gives an extremely durable handle. Do not use it if you want a lightweight knife.

The pattern is quite plain, but can be mottled or striped. This wood is oily and very dense. It polishes well and is extremely durable. It grows from Mexico to South America. Weighs 83 lbs. per cubic foot.

### LOURO

It ranges in color from dark walnut to light cream, with bands of light purple to black. It is an easy wood to work and takes a good, but not particularly lustrous finish. Oiling accents its color and grain.

### MADRONE BURL

This is a scarce beautiful wood with a characteristic burl figure throughout. Coloration is a reddish tan with darker tan swirls, flecks of very dark reddish brown and occasional creamy white flecks. A dense wood that achieves a brilliant glassy finish and one of the most dramatic woods we carry. It requires sealing. Weighs 44 lbs. per cubic foot.

### MAPLE

This wood (bird's-eye, curly, and fiddle back) is all white or cream, to light brown in color. Bird's-eye has small eyes scattered throughout the surface. Curly has wavy lines that make a shell pattern or parallel curving lines depending on the direction in which they saw it. Fiddleback possesses parallel lines of wavy grain from 1/8 to 1/4 apart. Staining and sanding can enhance these figures. The stain penetrates into the figure more deeply than it

## THE ADVANCE KNIFE MAKERS MANUAL

does the surrounding area, and the result is a darker figure against a very light background. Weighs 45 lbs. per cubic foot.

### MESQUITE

This wood has a medium texture that finishes easily. It is light to dark cocoa with a reddish cast that achieves a golden luster when polished, and the figure ranges from straight too wavy. It is hard and heavy. Weighs 55 lbs. per cubic foot.

### PADAUK

A dense, easy working wood is rich red to orangeade with alternate layers of hard and soft open grain. It is a beautiful, exotic wood highly prized because of its coloration. When exposed to light, this wood becomes a rich brown with red undertones. Weighs 45 lbs. per cubic foot.

### PEROBA ROSA

It is also known as Rosa, and it grows in southeastern Brazil. The color is rose-red too yellowish, often variegated or streaked with purple, or brown. The surface becomes brownish yellow to dark brown upon exposure to light. It has a low to medium luster. It is a hard wood. Weighs 46 lbs. per cubic foot.

### PINK IVORY

This is one of the more rarer and expensive woods that is found in South Africa, it is bright pink to pale red, very dense, and hard. The texture is very fine and takes a beautiful high polish. Weighs 70 lbs. per cubic foot

### PURPLE HEART OR AMARANTH

This wood originates in Mexico, Central America, Brazil and British Guyana and is a dull brown in color that turns to a deep purple up on exposure to air. It has little figures, even texture, hard and heavy, and works well. We must seal this wood. Weighs 65 lbs. per cubic foot.

### REDWOOD

Bird's-eye is a variety of redwoods that has wavy lines and bird's-eyes; it is a pinkish red color with dark streaks. It is a softwood and does require sealing; this wood has a great deal of pattern and makes an outstanding knife handle. Weighs two lbs. per cubic foot.

### ROSEWOOD

## THE ADVANCE KNIFE MAKERS MANUAL

This a heavy oily wood with a prominent figure on a background that varies from light rose, to dark violet, to almost black with darker streaks. This is an old favorite and has one of the most pleasing grains and colors of any wood. Oiled and polished, it takes on a deep purplish color, not as dark as ebony, but with more contrast. It works well and takes a high luster.

It finishes to a very beautiful natural sheen. There is much variety in the coloration of rosewood depending on where it is grown, but it is all beautiful wood. Weighs 47 lbs. to 68 lbs. per cubic foot.

### **SNAKEWOOD**

This is native to British Guyana and South America. It has a reddish brown tone with irregular black speckles or stripes. They often call this wood Leopard wood. It has a fine texture, takes a beautiful finish, and is a very rare and expensive wood. Weighs 75 to 84 lbs. per cubic foot.

### **THUYA BURL**

It is golden red with shades of brown burls, and is moderately hard and heavy, but it works well with tools and polishes to a fine luster. It is relatively rare and therefore expensive, but well worth the price. They import it from Algeria and Morocco. Availability dictates size and price of this wood. Weighs 42 lbs. per cubic foot.

### **TULIP WOOD**

This is a very colorful Brazilian hard wood with striking mauve, violet, or a rose red stripe contrasted by a creamy yellow. It is a strong, dense wood that is not to easy to work with, but it attains a high natural polish and is very soft for use as knife handles. This wood tends to darken when exposed to light but retains a rosy hue. Weighs 60 lbs. per cubic foot.

### **WENGE**

This wood is native to Africa. It is dark brown to black in an alternate layer that gives it a very distinctive appearance. It shows heavy veining that requires filling. The wood is hard, heavy, stable, and machines well. Weighs 60 lbs. per cubic foot.

### **ZEBRA WOOD**

It is also, known as Zebrano or Zingaua, it is an African wood, and gets its name for its pronounced striped patterns. As the name implies, this is a heavily figured wood with

## THE ADVANCE KNIFE MAKERS MANUAL

alternating bands of light tan to light cream, interspersed with black. It works as easily as walnut and buffs to a nice luster, and oil finishing accents the figure.

It is tan with narrow brown stripes. The grain is somewhat coarse in texture. It is hard, heavy wood that achieves a lustrous finish. They should fill and seal it. Weighs 45 to 55 lbs. per cubic foot.

### ZIRICOTE

This is a very hard, dark gray brown wood with highly irregular, prominent black lines that establish patterns totally unrelated to the grain of the wood. This results in a very striking appearance. It is native to Mexico and Central America. Ziricote attains an attractive high luster with polishing. Weighs 50 to 60 lbs. per cubic foot.

### LEATHER

There was a time when leather handles was about the only kind you could get in a store-bought sheath knife. Many disadvantages have caused it to lose favor in recent years, however; it tends to shrink and mildew unless properly cared for.

Cutting and laminating leather discs or a washer from heavy cowhide makes handles for knives. You can cut your own from 12 oz cowhides, or buy them precut and slotted. The average size knife handle requires about sixteen to eighteen washer's cut from 12-oz hides. They make the ones you buy from thicker stuff and they require only about fourteen.

They slip the washers over a round tang one at a time, and glued together using a good rubber-base contact cement. Then the handle is finished as you would any other material by shaping on a sanding disc and with rasps, and it is buffed to polish and then treat it with a leather preservative.

## EXOTIC HANDLE MATERIALS

### SAMBAR STAG

They import the Sambar stag from India. However, this deer ranges from India and Nepal to southern Asia. The mate of this large red deer bears long three tined antlers that it sheds annually. Polishing stag can be done on a fast or slow speed buff. If a fast wheel is being used, the stag may show some burn marks if it stays in one position too long.

They harvest these for knife handles and pistol stocks. Our experience over the past years suggests that the price will continue to increase. The Stag horn or antler used in the cutlery industry and is imported from India; it comes from the Chital (*axis axis*) and Sambar (*Corvus unicolor*) deer. They have shed these antlers and therefore they did not kill the animal for its horn.

Most of the brown color in stag comes from disinfecting. When stag enters this country, we that must boil it in a disinfectant with water for twenty minutes. The most popular disinfectant used is potassium permanganate. The residue will have a black color on the outside and a brownish red just inside the surface of the stag.

They can reshape irregular shaped slabs of stag. After they boil the stag for about five minutes, immediately take it from the boiling water to a vise. Place a piece of tubing over the stag and bend to the desired position. It may have to be held in this position until the stag cools.

### BUFFALO HORN

Buffalo horn comes from a domestic animal in Africa and India, but this material is unlike stag or bone. Buffalo horn is made up of many individual layers and will spread apart when it dries out. Reshaping it can be accomplished by boiling in water and then bending it and holding that shape until it cools.

Buffing should be done on a loose wheel at slow speed, because this material is very soft. Be careful grinding this material on the disc sander for the strands will grab the disc and pull it out of your hands.

### OOSIC

Oosic is the penial bone of the walrus. This is an excellent handle material for custom-made knives and polishes out like bone. The color ranges from white to dark brown for an old fossilized specimen, but the color is dependent upon how much fossilization and the mineral in which it was aged in.

# THE ADVANCE KNIFE MAKERS MANUAL

## BONE

Bone handle material is bone from the leg of a cow, and the appearance of the final product will depend on how they dye it, and if it has been jigged.

Since bone is usually hard to find for a handle material, check with your local butcher shop for some large pieces of bone. Remove the excess meat and fat and boil the bone for 1520 minutes to clean away any meat or fat that may be left. To make bone extra white we can boil it in a one part, solution of water and five parts, Hydrochloric Acid. Be very careful because hydrochloric acid will react with water and produce toxic and corrosive fumes.

# THE ADVANCE KNIFE MAKERS MANUAL

## JIGGING BONE

Jigging bone is the cutting of groves or notches into the bone for better hand holding power, and adds to the appearance of the material. Setting up a jigging machine would be very hard for a knife repairman, but can be accomplished with the Dremel tool with a disc cutter. In this operation, we can cut notches into the bone. Different cutters may also be used for different patterns.

## DYING BONE

The cell structure prevents the dye from absorbing into the bone, and many individuals that sell bone, dye their own bone using Rits Color cloth dye. They select the correct color and put the correct mixture of dye to water mixture in a pressure cooker. The bone is then added to the mixture and the lid is put back in place. They then boil the bone in the pressure cooker for twenty or more minutes to achieve the correct color and depth.

## MOTHER OF PEARL

Mother of pearl is a shell that comes from the ocean. This material is very brittle and cannot be bent anytime or it will break. When grinding pearl, the dust is Toxic and can cause Cancer, so remember to wear a dust mask. Pearl like most shells, is made up of calcium, and the particles from the grinding can injure your lungs.

The rivets should not be spun but peened lightly with the cut face hammer. It will help the peening if you anneal the rivets before they insert them. Be extra careful when you place the knife into the vise for the replacement of the center pin. It is important that the pearl is flush with the bolster scale or there will be a greater chance of cracking.

## ELEPHANT IVORY

Looking at a piece of ivory is very hard to tell if it is a synthetic. Old ivory will have a brown yellow cast about it. Ivory is a very soft material. It will grind and shape similar to some woods, but one main problem with ivory is cracking or developing age cracks. When buffing, use a loose buff at a slow speed.

## AMBER

Amber is a fossilized resin from pine trees that grew fifty million years ago. The color of Amber is a rich golden, transparent amber with random opaque swirls throughout.



# THE ADVANCE KNIFE MAKERS MANUAL

## IMPALA

This is from the impala antelope that is native to southern Africa. This horn has the typical fluting, up swept tip characteristic of the species, and is a beautiful black color.

# THE ADVANCE KNIFE MAKERS MANUAL

## KNIFE STEEL

What kind of knife steel should be use? There are several different types of steel that is available to the knife makers today. If you go to a knife show today and talk to several knife makers, you will find many different choices of perfect knife steels.

More than likely 440C will be the most popular. There are many common and exotic steels used for the knife blades today, some have very good qualities, some not any better than the old steel your grandfather used.

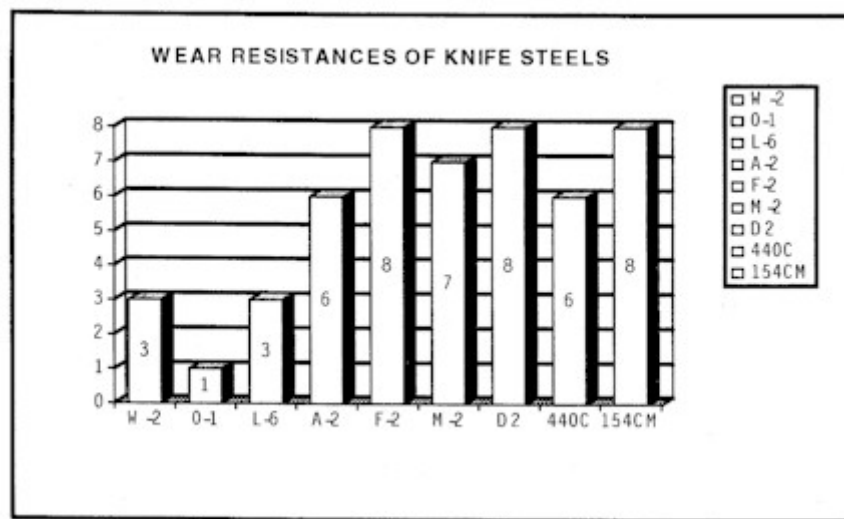

The main common steels that I have used, and the ones that most knife makers use, they are 01, D2, 154, and 440C. I have used just about every type of steel that I could get my hands on over the years. I have made several knives from farming equipment steel such as plow shears, disks, and the like. Plow shears, disks, chisels, etc., makes very good knives. I do not know of the analysis of the steel, but it wears very well. The main problem with this type of steel, and most other Tool Steels, is with the high carbon content, for they rust easily. As stated before, I have gotten around this problem by using Marine Tuff.

If you want a knife that will hold a good edge, a hardness of 59 Rc to 62 Rc is important. 440C makes a good blade, but the hardness of more than 58 Rc is very hard to achieve.

There is also a trade off, for a blade that will hold an edge good. First a blade that will hold a good edge will be hard; about 60 Rc to 62 Rc., and at this hardness, the blade will be brittle.

It will make a very good knife, with exceptional edge holding ability, but it is only used for what they make a knife, and that is, CUTTING. This blade will snap if used for prying, or a screwdriver.

To make a blade that will withstand a little bit of prying, the hardness is lowered to 55-58 Rc.

## THE ADVANCE KNIFE MAKERS MANUAL

This will make it flexible, but the edge holding ability is usually not very good.

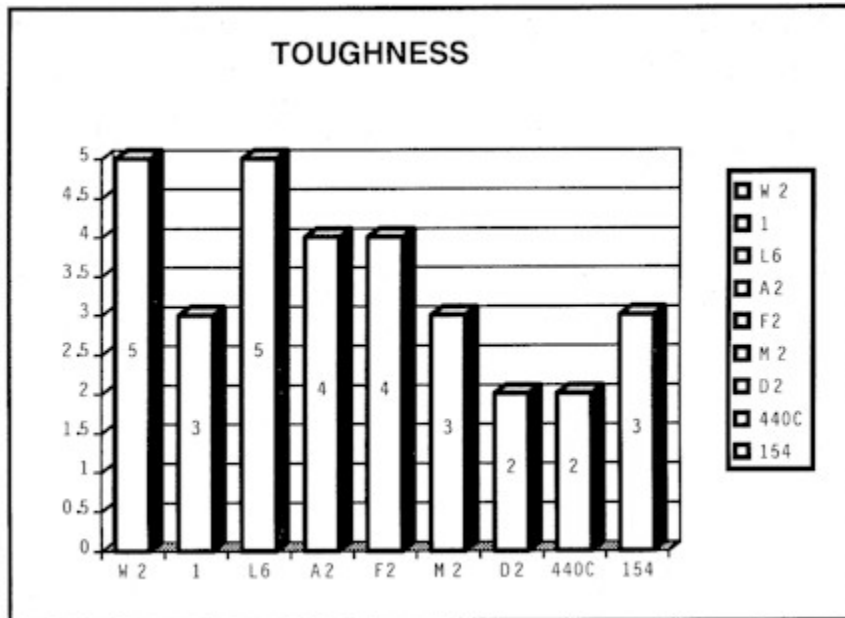

I have almost totally gone to 01 tool steels for my knife blades. I am very familiar with this steel, as I have used it for more than thirty years when I was manufacturing rifle barrels. We made all of my metal cutting reamers from 01 Tool Steel. The reamers were used to ream the hardened steel used in rifle barrels.

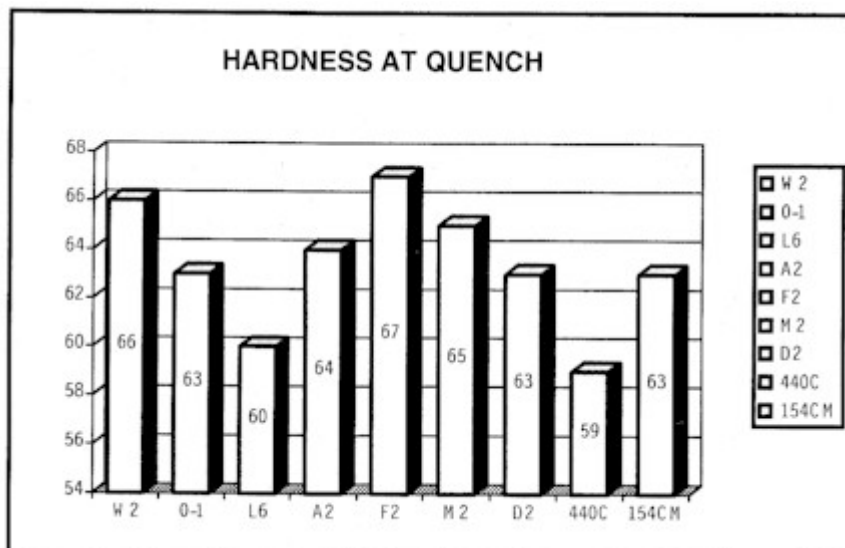

There is another advantage of using good carbon steel. If we grind the blade to a final thickness on the cutting edge of, .020 or less, a shaving edge is very easy to attain. On edge holding, and cutting ability, the main secret is to have the cutting edge held to the .020 or less thickness. I do not know if you are aware of this, but you have had knives that just will not hold an edge. One of two things probably exists. The blade is too soft, or we have

## THE ADVANCE KNIFE MAKERS MANUAL

ground it, as I would call it, an axe grind. This axe grind is used on many different knives, mostly the cheaper ones. It is a very useful shape if you want a knife to be able to take a rough use. It is a useful shape for a hunting knife used for all kinds of camp chores.

# THE ADVANCE KNIFE MAKERS MANUAL

## TYPES OF KNIFE STEEL

We class this tool steel, as a cold work die steel. This grade of steel is the most common of tool steels. It is found in most tool and die shops, and is the workhorse steel for all tools.

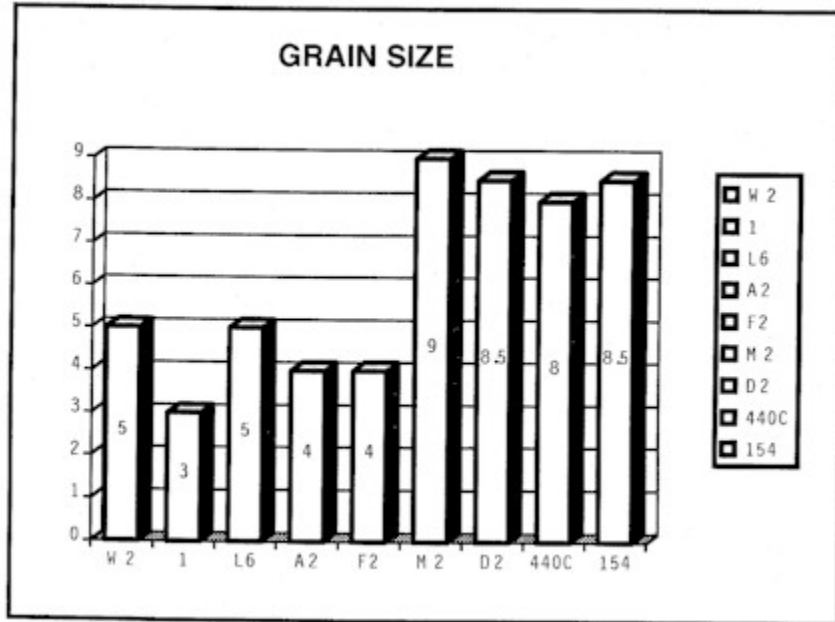

It has a good manganese content that allows this steel to be oil hardened quench. 01 is a very stable steel, and you will find that you get very little warping or cracking that you would normally experience with other high carbon steels. See the charts for comparison of wear, hardness, etc. I would recommend this as a good starting steel, as using it is easy.

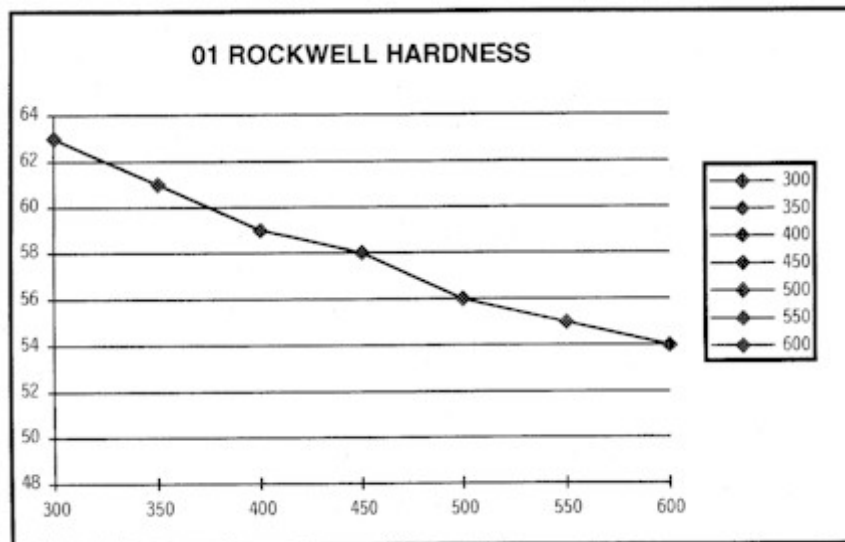

We know W2 as carbon-vanadium tool steel. It has a small amount of vanadium that helps

## THE ADVANCE KNIFE MAKERS MANUAL

to eliminate grain growth if it is over heated. We should regard it as a water hardening carbon tool steel.

You can get W2 in various carbon contents, ranging from about .60 to 1.4 percent. If you use this steel, try to get a carbon content of at least 1.00 or above. This higher carbon content will make a harder blade.

We heat this steel to 1500 degrees, and quenched in a brine solution or water. A brine solution is my favorite as the steel comes out clean and bright after quenching.

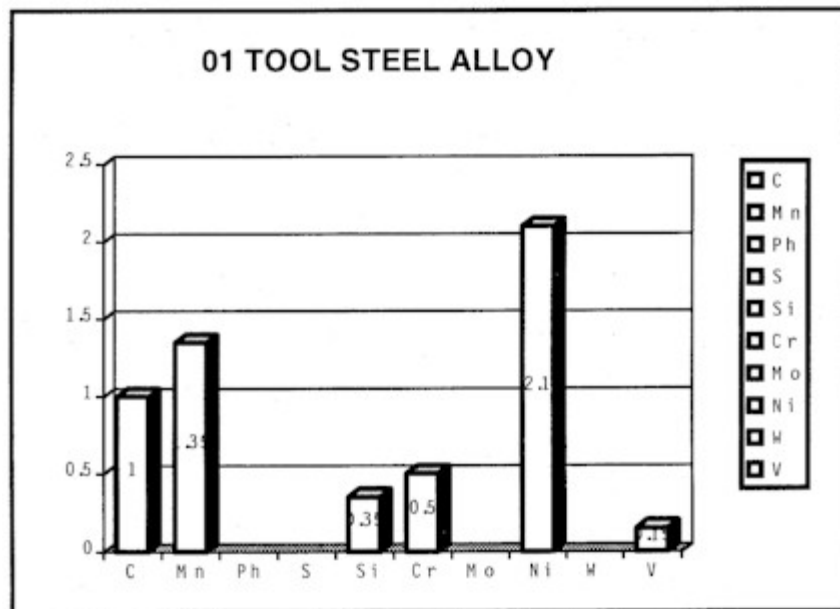

The water or brine should be 100 to 125 degrees when you quench the blade. There is a trade off using water or brines, using these to quench the blades; you may get some warping.

The use of Carbon steel has one other advantage. You can draw the hardness on the back of the blade (or spine) to give the main part of the knife toughness, and leave the cutting edge hard.

Many people have access to saw blade material. In some areas, there is quite a bit of lumber work. The big saw blades make excellent knife blades. Most, but not all use an alloy similar to L6. The L stands for low alloy. What this means is that it is mainly a high carbon steel. It has a fair amount of nickel, and that is what gives it great toughness.

This steel has good wear resistance, and great toughness. It is an oil hardening steel. This material has more alloys added to it, and it is a better grade of steel. It has quite a bit more toughness and wears resistance over 01. With the 5 percent of chromium added, it has a mild corrosion resistance. Another draw back is that you need to go to a higher temperature for hardening (1,750-1800 degrees F.).

## THE ADVANCE KNIFE MAKERS MANUAL

We should heat this steel to 1,400 degrees, rather slowly, and dipped in brazing flux. This is to protect it from decarburization. It is soaked at 1,400 degrees for fifteen minutes to relieve any stress, and then brought up to temperature. At 1700 degrees, we remove it from the furnace and cooled in still air.

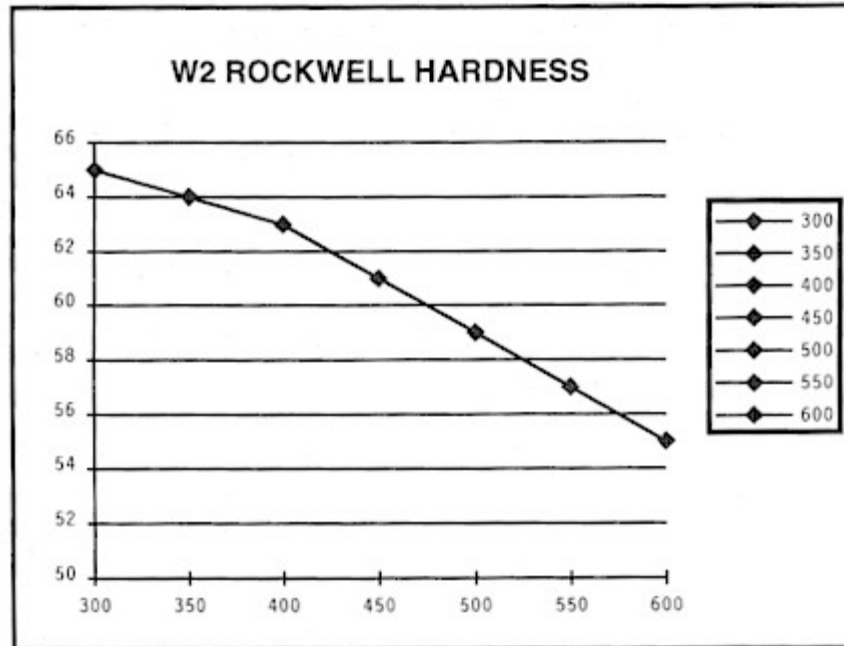

We recommend that you leave extra stock on the blade for grinding any decarburization from the blade. If you want to get a 2-3 point harder blades, you can use what they call a sub-zero quench. You will not lose any toughness by doing this. What happens, is that at room temperature it will not convert all the austenite to martensite?

If you want to use this process, get some dry ice, put it in an ice chest and pack the blades with the dry ice.

This steel is used in cutting tools for metal, and it has a very hard and wear resistance cutting edge. As with most special steels, it is rather expensive. For special blades, this is a good choice.

When heat-treating it is **IMPORTANT NOT TO HEAT IT MORE THAN 1600 DEGREES**. If you should do this large grain size, with poor strength and wear will be the result.

## THE ADVANCE KNIFE MAKERS MANUAL

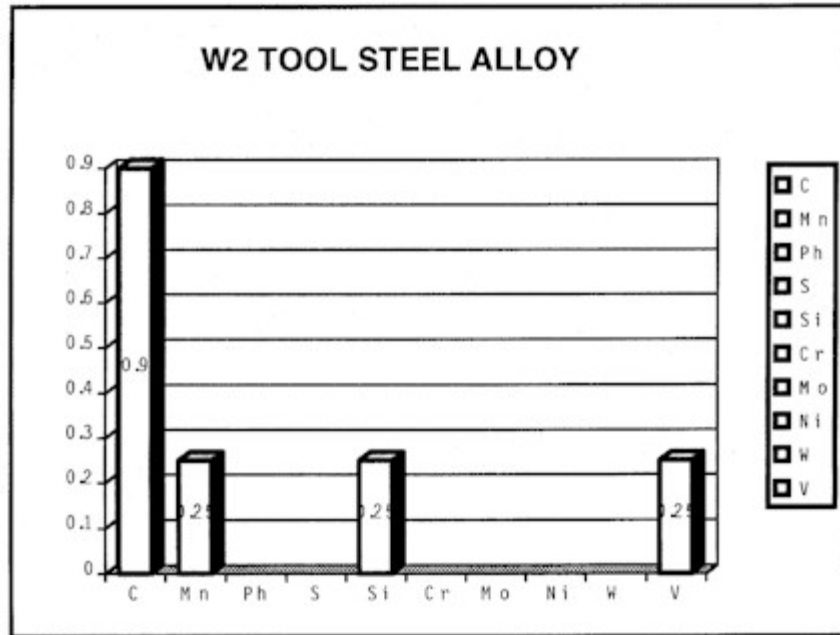

This is another steel used in the machine shops for cutting bits for steel. This steel can be over heated when finish grinding without losing any hardness.

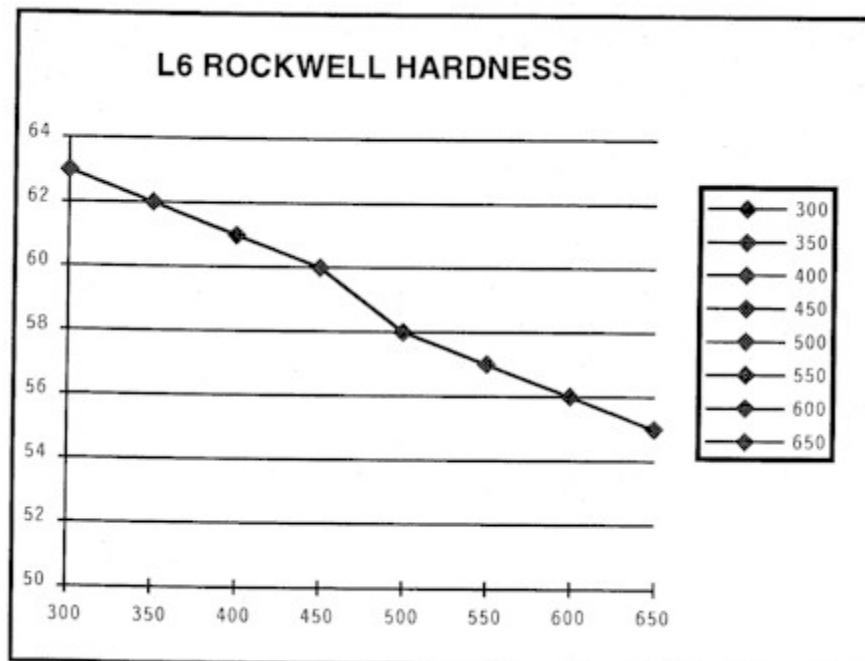

In heat-treating, leave plenty of metal to remove in the finish grinding, to remove the decarburization. Look at the tempering chart for this steel. 1050 to 1100 degrees is a good draw temperature.



## THE ADVANCE KNIFE MAKERS MANUAL

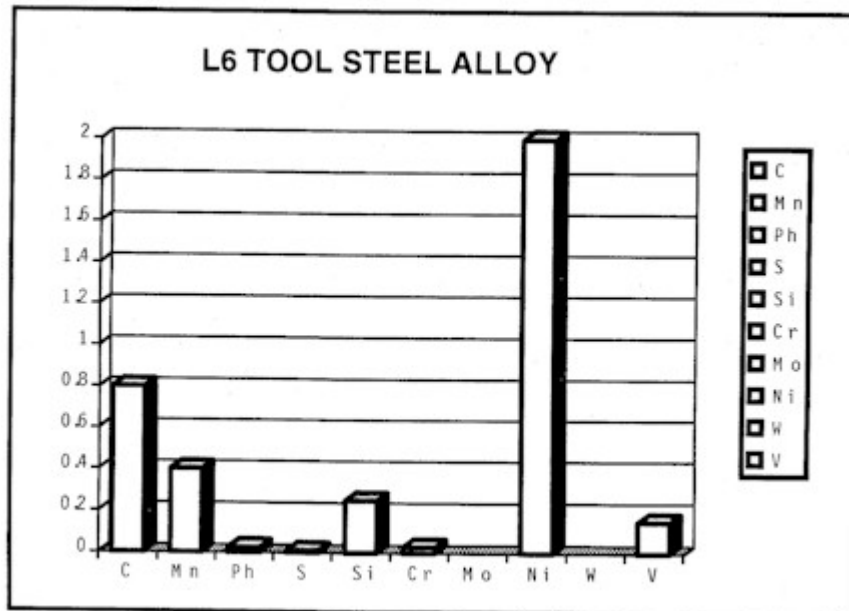

This is the old standby. It is the best choice to make for good knife blades, if you want stain resistance steel that will hold a good edge. It is almost as popular as 440C and has exceptional wear resistance from the high carbon and chromium content.

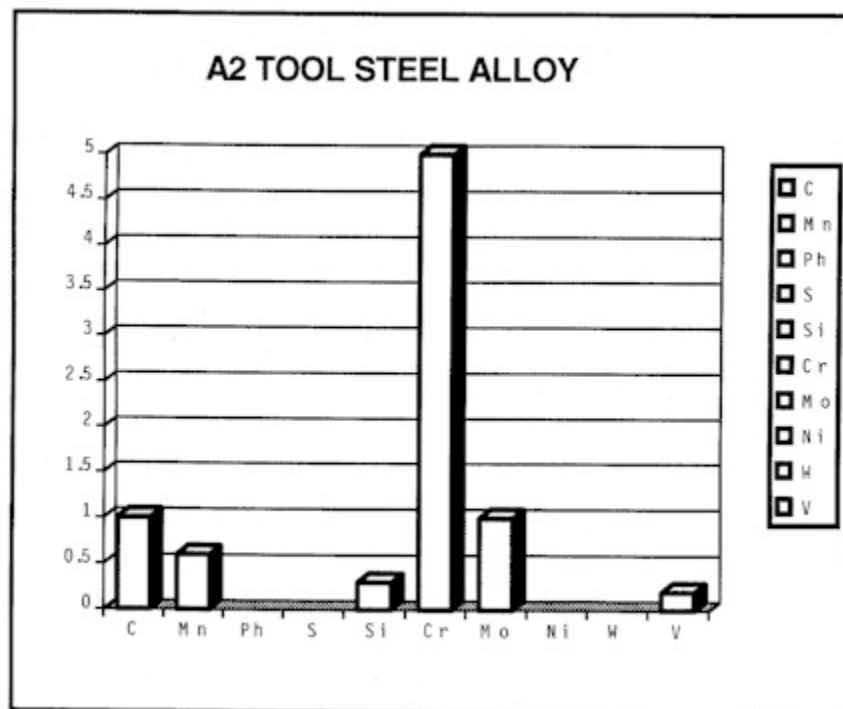

My one complaint is that it is rather brittle. If the blade is used for only cutting, it cannot be bent or pried on, and as I said before, it is a good stain resistant steel.

## THE ADVANCE KNIFE MAKERS MANUAL

We dip and coat this steel with brazing flux, or wrapped in Stainless steel foil to prevent decarburization. Tempering should be for 3-5 hours.

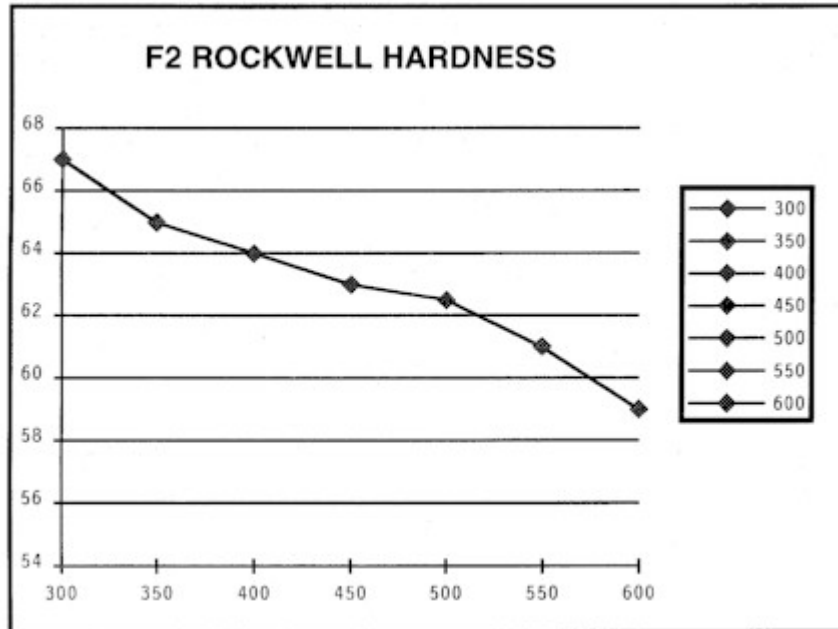

They have made most of the knives in the last thirty years from 440C. Most of the factory knives have a hardness of 52-55 RC. This low hardness has given 440C a bad reputation for not holding an edge, and being hard to sharpen.

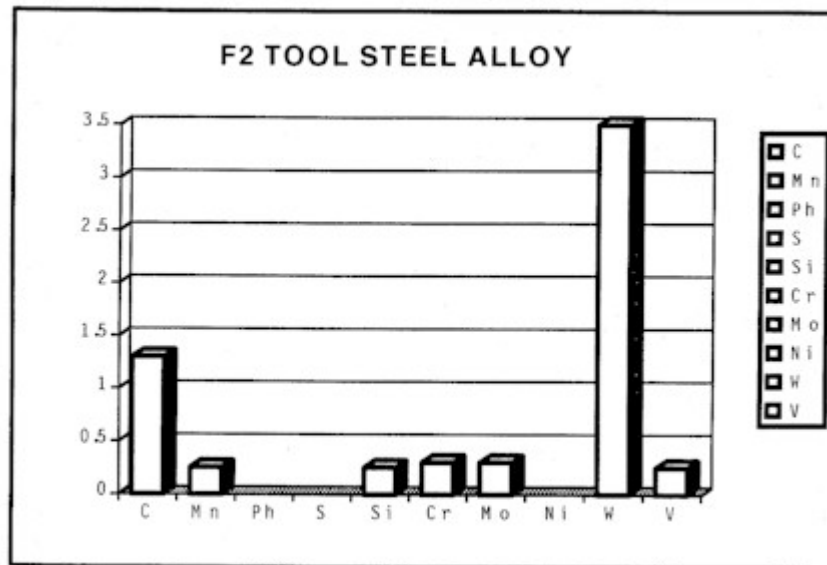

The hardness at quenching is not too hard, a mere 59 Rc. When you temper the blade, it reduces the hardness even further. If you temper it at 225 degrees, you will retain most of the hardness, but it will be brittle. The edge will chip very easily. If you draw the temper so to

# THE ADVANCE KNIFE MAKERS MANUAL

remove the brittleness, the blade will not hold a good edge, and sharpening it also will be difficult.

### M2 ROCKWELL HARDNESS

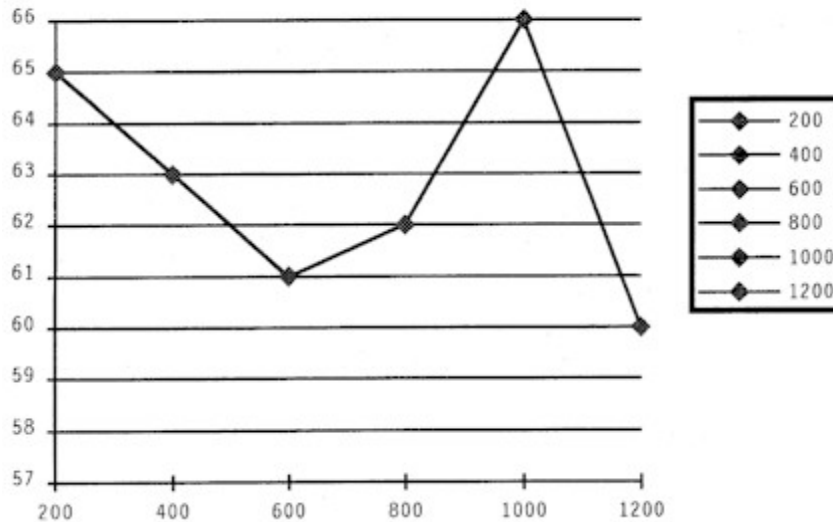

However, for fishermen, people who carry small knives to open letters, clean their fingernails, etc., this steel will work well. If you build art knives or a knife for a person that puts in his collection, 440C is the best choice.

They developed 154 CM from 440C so you could have a steel that could be heat treated to a hardness of three to four points harder than 440C. There also is no sacrifice in toughness. I would have to rate it on wear and performance in the same category as F2 or M2. I would recommend this steel as an all-around knife steel.

### M2 TOOL STEEL DATA

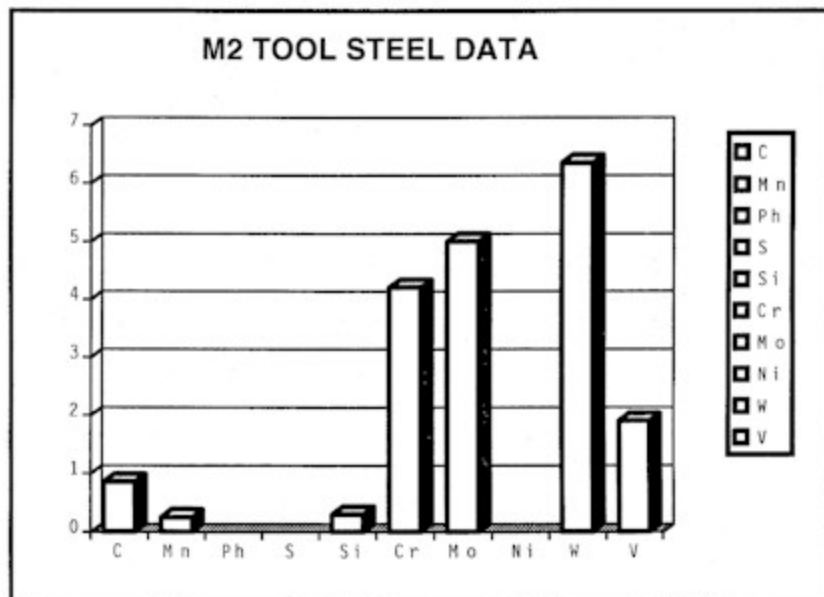

## THE ADVANCE KNIFE MAKERS MANUAL

You may have some problem in finding suitable sizes for folding knives. Heat-treating 154 CM is similar to 440C. It should be soaked for about twenty minutes at 2000 degrees, and quench in oil or water. Unless you coat the blade good, or wrap it in a stainless steel wrap, you will get much decarburization.

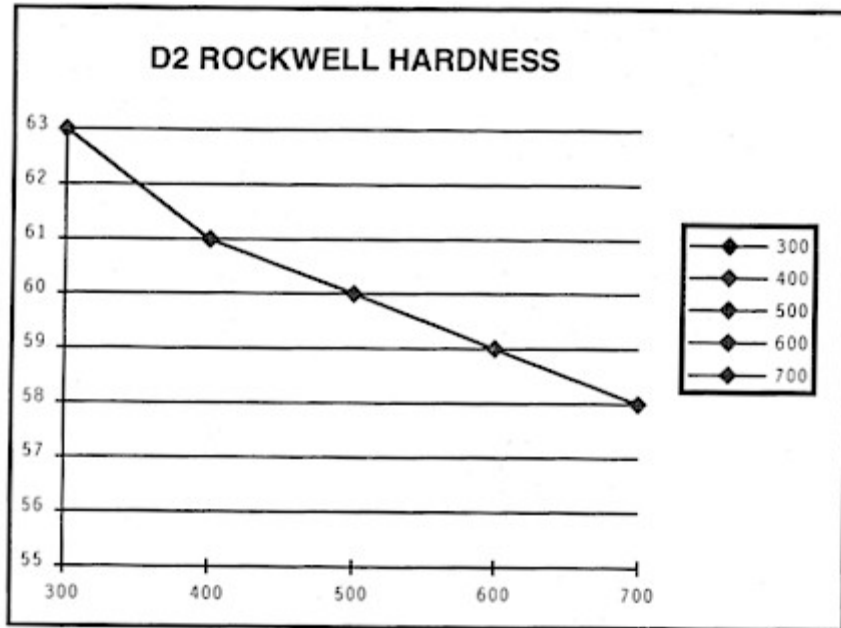

For your first knives, I would recommend 01 tool steels. Working with it will be easy and give you excellent results.

# THE ADVANCE KNIFE MAKERS MANUAL

## HEAT TREATING TOOL STEEL

I will now cover as much as possible the heat-treatment of the tools and cutters that you will be making. To prevent the spoilage of tools during heat-treatment, it is important to understand the changes that take place in the steel when we have heated, quenched, and tempered it.

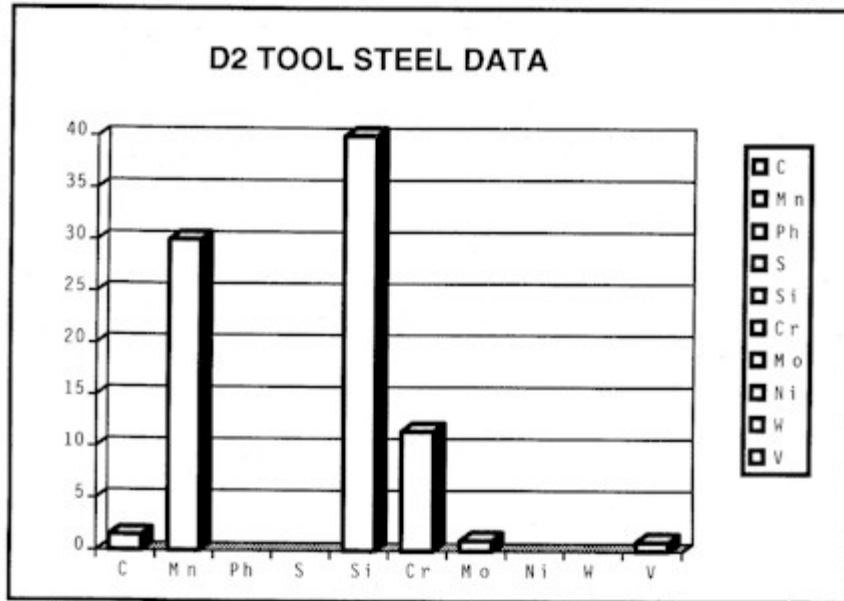

This chapter deals with the heating cycles for typical tool steels, the quenching or cooling procedure, and the effects of single tempering operations on the structure and properties of the steel.

Usually, the life of tools is proportional to their hardness, and can be achieved in a plain carbon steel by heat-treatment, if the steel contains over about 0.50% carbon, provided the section is not very large. When we make tools in large sections, we cannot harden plain carbon steel adequately, and adding alloying elements to increase harden-ability is necessary.

The elements usually used for this purpose are chromium, manganese, and molybdenum.

Steel becomes hard during heat treatment because of the formation of a micro structure called martensite. For some tool applications, the wear resistance provided by the martensitic structure alone is not sufficient, and therefore, tungsten and vanadium and chromium and molybdenum, introduced into tool steel. These elements combine with some of the carbon in the steel to form very hard particles of carbides. Thus, give the heat-treated steel much better abrasion resistance than can be developed without the presence of alloy carbides.

## THE ADVANCE KNIFE MAKERS MANUAL

When the tool operates at high speed or under high pressure or is in contact with hot metal, as in forging, etc. Special tool steels must be used that is resistant to the high temperatures encountered. Vanadium, cobalt, and chromium combined with tungsten or molybdenum gives the steel the necessary resistance to softening at high temperatures.

Finally, in some applications, the life of the tool is more dependent on toughness than on hardness.

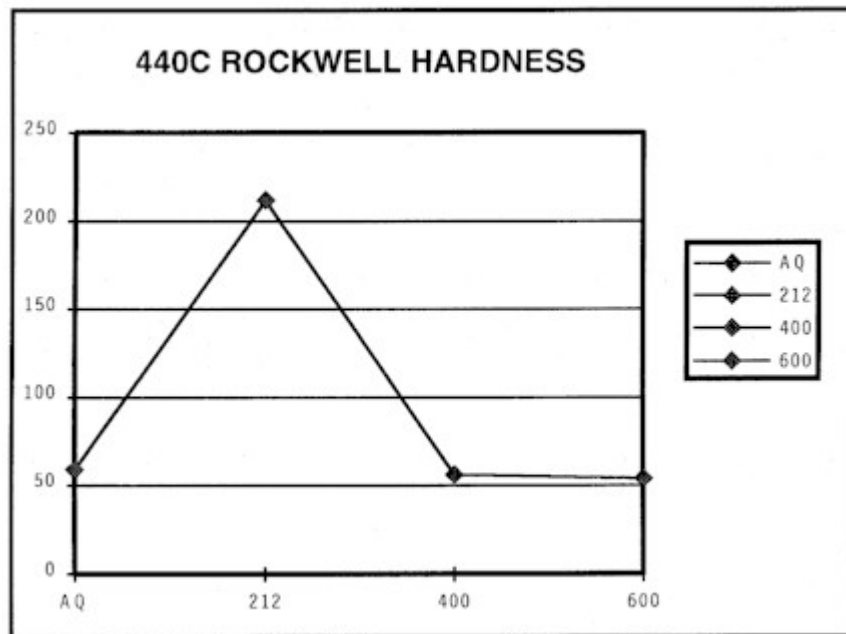

### THE COMPOSITIONS OF TOOL STEELS THAT WE USE FOR TOOL MAKING ARE

Plain Carbon Tool Steels Carbon 1.14; Manganese 0.22; Silicon 0.16 per cent.

Oil Hardening Tool Steel Carbon 0.85; Manganese 1.18; Silicon 0.26; Chromium 0.50; Tungsten 0.44 per cent.

High Carbon High Chromium Tool Steel Carbon 1.55; Manganese 0.27; Silicon 0.45; Chromium 11.34; Vanadium 0.24; Molybdenum 0.53 per cent.

Molybdenum High Speed Steel Carbon 0.80; Manganese 0.24; Silicon 0.29;

Chromium 4.15; Vanadium 1.89; Tungsten 6.64; Molybdenum 4.94 per cent.

Chromium Molybdenum Hot Work Steel Carbon 0.38; Manganese 0.40; Molybdenum 1.35; Nickel 0.30 per cent.

## THE ADVANCE KNIFE MAKERS MANUAL

1. Steel of the first analysis listed is usually called plain carbon steel. It is also frequently a water hardening, or shallow hardening tool steel.

2. The next analysis is characteristic of Steels referred to as Oil Hardening, and differs from the first type primarily in harden-ability. This is the basic type of tool steel that I have used for more than thirty years.

Because of its greater harden-ability, an oil can harden large tools made of this steel quench rather than a water quenches. Tools made of the oil hardening tool steels do undergo as much size change and distortion during hardening as those made from plain carbon steels.

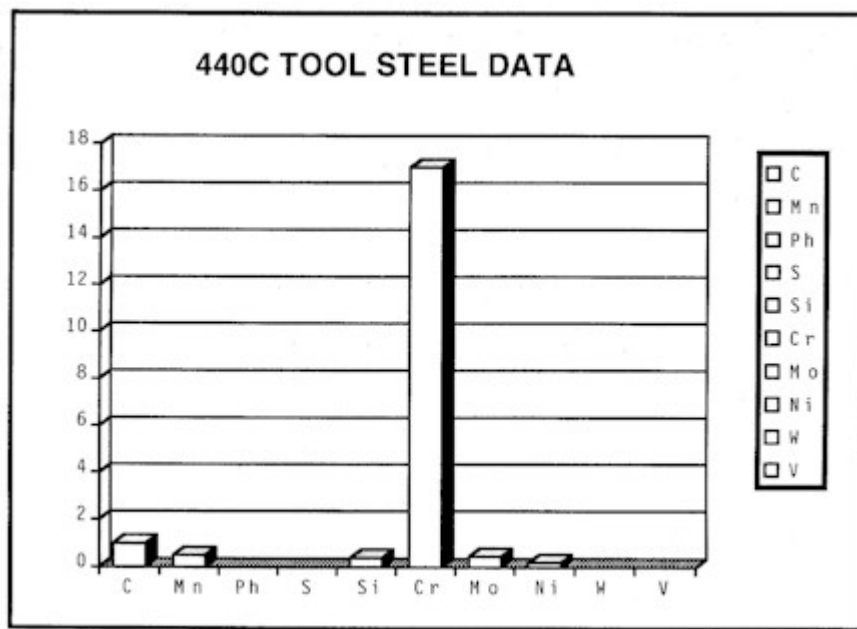

They refer to steel of the third analysis as a high carbon, high chromium steel or as an air hardening tool steel.

The last two steels are not used in the small shops, as they require special equipment to process them.

## THE ADVANCE KNIFE MAKERS MANUAL

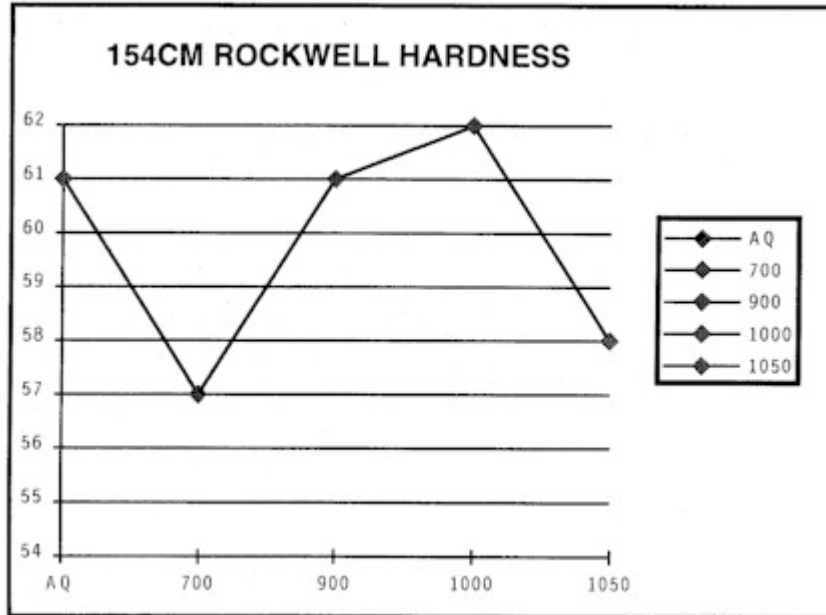

The first step in the heat treatment of steel is the heating. The purpose of the heating is to form austenite and to dissolve carbon in the austenite. The solution of the carbon is necessary so in the second step of heat treatment, when the transformation of austenite takes place, the steel will develop the desired hardness. You must remember that although a large amount of carbon is in the steel. It is not effective in developing hardness unless it is first dissolved in the austenite.

The hardness increases rapidly up to 60 Rc as the carbon increases to 0.40 to 0.70%. Above about 0.70 % carbon, the hardness remains practically constant.

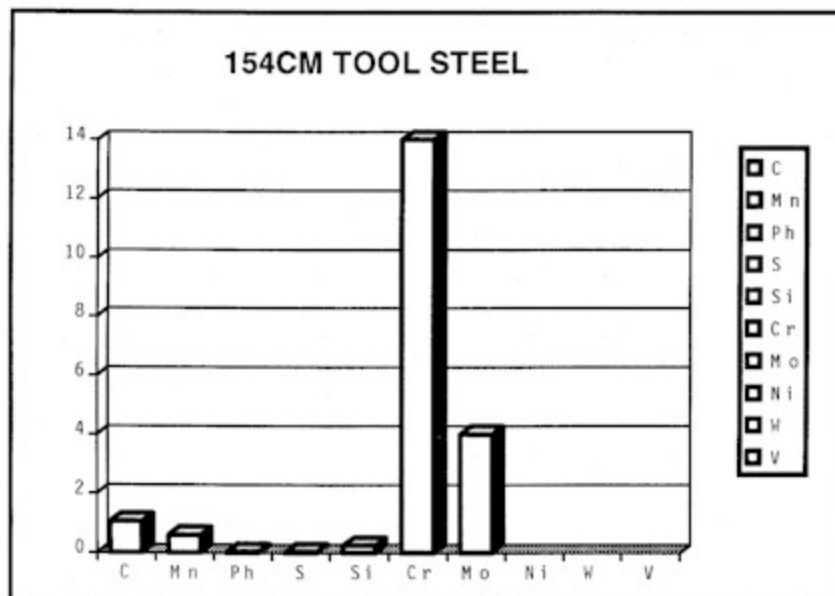



## THE ADVANCE KNIFE MAKERS MANUAL

For maximum hardness in the steel, they must dissolve 0.70 % of carbon in the austenite. All the steels being discussed, except the chromium molybdenum hot work steels have enough carbon in the analysis to attain a hardness of 65 Rc. in the heat treatment.

Two other factors are involved in the heating of tool steels, besides the formation of austenite and the solution of carbides. These are grain coarsening and melting of the steel. In tool steels, the grain size should be as small as possible. The reason for this is that fine-grained hardened steel is inherently tougher than a coarse-grained steel. Usually, there is little concern about coarse grain in a tool steel because coarsening of the steel does not occur until the temperature is well above the usual austenitizing temperatures.

Over the years, I have used Ryerson Tool Steel in 90% of my tools and reamers with complete satisfaction. They gave long life of tools, and overall good results.

AISI-SAE W2-1.00 Carbon-Vanadium. This is an all-purpose water hardening Carbon-Vanadium Tool Steel with remarkable hardening characteristics that permit a wide variation in treatment with uniformly good results. Used for punches, blanking and forming dies, shear blades, bending dies, etc.

Effects of tempering on a 2-inch disc, inch thick, water quenched at 1450 degrees.

	<b>As Quench</b>	<b>100 deg</b>	<b>200 deg</b>	<b>300 deg</b>	<b>400 deg</b>	<b>500 deg</b>	<b>600 deg.</b>
Rockwell C	67	67	67	65	62	59	55

This is one of the tool steels that I used, along with 01. This is an oil hardening tool steel that combines high and deep hardness with minimum distortion, freedom from cracking and good machine ability. Used for cams tolls, thread-rolling dies, thread chasers, blanking dies and punches, bushings, etc.

Working Temperature - Forging; 1800 to 1925 degrees F., never below 1550 degrees F.

Hardening; 1400 to 1475 degrees F.

Annealing; 1375 to 1425 degrees F.

	<b>As Quenched</b>	<b>300 deg</b>	<b>400 deg</b>	<b>500 deg</b>	<b>600 deg</b>	<b>700 deg</b>
Rockwell C	64	2.5	60	57	53.5	51.5

Similar to 02 above.

# THE ADVANCE KNIFE MAKERS MANUAL

## HARDENING

Hardening-The rate of heating for hardening should be slower for alloy steels than for plain carbon steels. The higher the alloy content, the slower the heating rates should be. Slow uniform heating can reduce or eliminate much difficulty with warping or size change.

If you have a gas furnace start the heat low, and bring up the temperature in steps, this takes about thirty minutes. Always put the tools in the oven before they start it. This preheating is not always necessary for the water hardening or oil hardening groups, but I have found that this usually eliminates warping.

I have found also that this preheating will reduce the time in a hardening furnace without atmosphere control and reduce scaling and decarburization. (\*)

(\*) We can buy commercial compounds for temperatures up to 1550 degrees. Brass brazing flux can be used also, and it works up to 2200 degrees.

We must hold the steel at a temperature long enough to be sure of uniform temperature throughout the entire piece. They require longer time at temperatures for the high alloy steels. When heating 01 or 02 steels, holding a slightly rich flame on the gas furnace is necessary. This helps to keep from getting a soft skin on the surface after quenching.

I have used quite a variety of liquids to quench the tools in over the years; here are some that I have used.

Water as it comes from the faucet, but I have not got to good a result, as there may be too much air in the water. If you use water, keep the temperature at sixty to eighty degrees.

This will produce a more uniform quench if not more than 10% salt by weight is added to the water. I have found that it will produce a much cleaner and uniform surface on the tools. As with tap water, we should hold temperatures at sixty to eighty degrees. After quenching, dip in oil to eliminate rusting.

I normally use 5-weight oil for all my quenching. Any mineral oil 5-weight or less will work well. We should hold the temperature of the oil to 100 to 130 degrees F.

You may quench Carbon Steels in a 5% lye solution with very good results. I have found that it will eliminate soft spots in the steel. It will also give a bright finish, and it will not rust the tools if they do not dip them in oil.

Now comes the most important part of heat-treating process and that is of tempering of the metal. We can temper Harden steel to make it softer and less brittle.

# THE ADVANCE KNIFE MAKERS MANUAL

Reheating it to a predetermined temperature, depending upon the nature of the steel and its intended use, and then the cooling.

When the tempering by the color method, the colors formed on the surface of the polished metal gauge the temper as the heat increases. The color method of gauging temperatures is not dependable, as the color is affected, to some extent, by the composition of the metal.

Temperlac is a compound that you can buy, in any temperature range, to put on the metal. When it melts, you have the metal at the proper temperature, but having a temperature gauge to get the correct temperature is better.

After you have worked with a certain type of steel for a while, you can judge the correct temperature by the color. Polish the metal to a bright finish so we can see the color clearly.

## **DRAWING BACK**

430 degrees; Very pale yellow, extra file hard, dies, milling cutters, cut off tools.

440 degrees; Light Yellow, file hard, reamers, thread chasers, fly cutters, hollow mills.

450 degrees; Pale straw yellow, profile cutters for milling machines, rolling dies, knurling tools.

460 degrees; Straw yellow, knife hard, swages.

470 degrees; Deep straw yellow.

480 degrees; Dark yellow, cutting dies.

490 degrees; Yellow brown, extra hard, taps, dies.

500 degrees; Brown yellow, thread dies for general work.

510 degrees; spotted red brown.

520 degrees; Brown purple, hard.

530 degrees; Light purple.

540 degrees; Light purple.

## THE ADVANCE KNIFE MAKERS MANUAL

550 degrees; Dark purple.

560 degrees; Full purple.

570 degrees; Dark blue, half hard.

620 degrees; Blue gray, spring temper.

752 degrees; Red heat, visible in the dark.

885 degrees; Red heat, visible in the twilight.

975 degrees; Red heat, visible in the daylight.

1077 degrees; Red heat, visible in the sunlight.

1292 degrees; Dark red.

1472 degrees; dull cherry red.

1652 degrees; Cherry red.

1832 degrees; Bright cherry red.

2015 degrees; Orange red.

2192 degrees; Orange Yellow.

2372 degrees; Yellow white.

2552 degrees; White welding heat.

2732 degrees; Brilliant white.

2912 degrees; Dazzling white, bluish white.

In tempering, I let the oven cool down to the temperature that I need to draw the temper for the job that I need. Then I put the part in the oven, then let it cool down over night.

Sometimes you may need to anneal the tool to do some machining or changing. The annealing of steel consists in heating it slightly above the critical temperature range and

## THE ADVANCE KNIFE MAKERS MANUAL

cooling it slowly in the oven, and when the steel cools, we have totally annealed it.

We hold the steel at this temperature usually not less than one hour for each inch of the thickest section of the part being annealed. By annealing after machining this will also remove any stress or hard spots caused by machining.

The temperature required for annealing varies for different steels. We can anneal low carbon steel at 1650 degrees F. We should maintain the temperature long enough to heat the entire piece evenly throughout.

You should take care not to heat the steel much above the decalescence or hardening point. When they heat steel above this temperature, the grain assumes a definite size for that particular temperature, the coarseness increasing with an increase of temperature.

Moreover, if the steel that they have heated above the critical point is cooled slowly, the coarseness of the grain corresponds to the coarseness at the maximum temperature. Therefore, the grain of annealed steel is coarser, the higher the temperature to which they heat it above the critical point.

I hope that you will find this information useful. Harold Hoffman

# THE ADVANCE KNIFE MAKERS MANUAL

## HEAT TREATING

The first step in the heat treatment of steel is the heating. The purpose of the heating is to form austenite and to dissolve carbon in the austenite. The solution of the carbon is necessary so in the second step of heat treatment. When the transformation of austenite takes place, the steel will develop the desired hardness.

You must remember that though a large amount of carbon is in the steel, it is not effective in developing hardness unless it is first dissolved in the austenite.

The hardness increases rapidly up to 60 Rc as the carbon increases to 0.40 to 0.70%, above about 0.70% carbon, the hardness remains practically constant. For maximum hardness in the steel, therefore, approximately 0.70% of carbon must be dissolved in the austenite. All the steels discussed here, except the chromium molybdenum hot work steels have enough carbon in the analysis to attain a hardness of 65 Rc.

Two other factors are involved in the heating of tool steels, besides the formation of austenite and the solution of carbides. These are grain coarsening and melting of the steel, but in tool steels, the grain size should be as small as possible.

Fine-grained hardened steel is inherently tougher than coarse-grained steel. Usually, there is little concern about coarse grain in tool steel because coarsening of the steel does not occur until the temperature is well above the usual austenitizing temperatures.

When we heat steel above this temperature, the grain assumes a definite size for that particular temperature, the coarseness increasing with an increase of temperature. Moreover, if the steel that we have heated above the critical point is cooled slowly, the coarseness of the grain corresponds to the coarseness at the maximum temperature. Therefore, the grain of annealed steel is coarser, the higher the temperature to which it is heated above the critical point.

Fire up the heat treat furnace if you have a gas furnace, or turn on the electric furnace.

NOTE - If you have a gas furnace light up a butane torch, and turn on the blower. Holding the torch over the opening, slowly open the gas valve, and there will be a poof as it lights.

Do not open the valve too much when you do this. You want to see three to three inches of flame coming from the top of the furnace, no more or no less. This is a slightly rich flame, but is needed to help to keep the metal from decarbonizing.

If you have an electric furnace you will need to get some stainless steel foil, found in most knife makers catalogs.

# THE ADVANCE KNIFE MAKERS MANUAL

Do to the time the blades are in an electric furnace, if you do not wrap the blade in stainless foil it will decarbonize badly. The blade has to be wrapped tightly in this foil.

With the gas furnace, turn down the air and gas until the temperature reaches 1000 degrees. Hang the knife by small hooks made from wire in the opening, and when it starts to get a dull red, then dip it in a non-scaling compound.

Make sure it is completely coated good, it will melt and form a protective coating on the blade. Put the blades back in the furnace, and increase the air and fuel slightly and it should slowly go up to 1550 degrees.

To get a uniform temperature, raise the blade up toward the top of the furnace, and move the temperature sensor up to the top of the furnace. For you who have good color sight, you can use the color of the metal to arrive at the correct temperature.

I would strongly recommend that you use Tempilaq to see the correct temperature. Tempilaq can also be purchase from Brownells. It comes in just about any temperature you would want. With Tempilaq, you can do an accurate job of hardening without a temperature gauge. This is good if you are only doing a few.

## COLOR AND HEAT RANGE

752 degrees: Red heat, visible in the dark.

885 degrees: Red heat, visible in the twilight.

975 degrees: Red heat, visible in the daylight.

1077 degrees: Red heat, visible in the sunlight.

1292 degrees: Dark red.

1472 degrees: Dull cherry red.

1652 degrees: Cherry red.

1832 degrees: Bright cherry red.

2015 degrees: Orange red.

2192 degrees: Orange Yellow.

# THE ADVANCE KNIFE MAKERS MANUAL

2372 degrees: Yellow white.

2552 degrees: White-welding heat.

2732 degrees: Brilliant white.

2912 degrees: Dazzling white, bluish white.

Have your quenching oil ready when the blades get to the right temperature (1500 to 1550 degrees). This oil can also be purchase from Brownells.

When the temperature is right, or the Tempilaq melts, raise the knife from the furnace and lower it straight into the oil. Make sure the blade is not swinging when it hits the oil, as that may cause it to warp. Once in the oil, gently agitate it to cool it thoroughly.

440C is very similar to 01 with the following two exceptions. (1) We bring 440C to a higher temperature. (2) We quench 440C in air rather than water. We bring 440C to a temperature of 1850 to 1900 degrees. It is best to heat treat this steel in an electric furnace, because there can be slow heating, and very controlled temperatures.

Take a piece of stainless steel foil, large enough to wrap the blade up in. Wrap the blade so the blade will be airtight. This is important as the time and the temperature in the furnace will cause the steel to decarbonize rather fast. If you tried to heat treat stainless without some protective coating, you would have to grind several thousands off to get to reach the hardened steel.

If you have a temperature gauge that will go high enough, you can dip the blade in brazing flux. This is done after preheating the blade to 1000 degrees. Using this method, you can use the gas furnace. You have to be careful, as the temperature will go high enough to melt the steel. If you are skilled enough at reading colors, you can use this method to establish the correct temperature. However, this method can be hit or miss.

## **440 C STAINLESS STEEL HEAT TREAT PROCEDURE**

1. Wrap the blades in tool wrap; double crimp all edges of the foil being careful to avoid having even a pinhole in the foil. You may double wrap for extra assurance of locking out all oxygen. You may wrap the blades with 5-6 stacked side by side or individually wrap and place them in a furnace rack. This rack will hold the blades in an upright position for reducing warping.

2. After placing the blades in the furnace heat to 1850 ° F., then after reaching 1850 ° F, start timing the soak time of 20-25 minutes.



## THE ADVANCE KNIFE MAKERS MANUAL

3. After the soak time has elapsed, carefully slide the blades on a steel grate or heavy wire mesh for room temperature cooling. (This is the air quench) Place aside for cooling. The grate or wire mesh will allow air to circulate under the blades and around them for uniform quenching.

4. While the blades are cooling, leave the furnace door open and allow it to come down to 220 ° F. Sometimes the blades will be cooled before the furnace comes down. Then, keep the blades warm (place near the furnace door) or you may use the kitchen oven for drawing. It is important on all grades that they do not cool much below the 125 ° F temperature before drawing. (There are furnaces for tempering or drawing also available).

5. After placing the blades in the 220 ° F. temperature, they should remain at this heat for two hours.

6. Pull the blades out for cooling and place them back at 200 ° F again for two hours.

7. Check hardness. You should have approx. 59 Rc. For extra stability, you may freeze the blades in dry ice for one hour. This will also increase the hardness a point or two.

Note: All the above procedure is based on our own experience, realizing that other people use some of their own trial-error. The equipment must be accurate and periodically the calibration checked.

There are no shortcuts for proper heat-treating, always exercise care to insure a good quality job.

When the blade has reached the correct temperature, remove it from the oven. Remove it from the foil and hold it in front of a fan to cool.

D2 is heat-treated the same way as 440C, except for the temperature. We bring up D2 to a temperature of 1750 to 1850 degrees. Then it is quench in air. You must to remove the foil as fast as possible. A good stream of air is important to achieve good hardening.

The choice of using 01, D2, or 440C is mostly personal. If you want a knife for carrying daily, and you do not want to have to worry about having to take care of it, then 440C is a good choice. Most knife makers like 440 also because it polishes out easily. Its main draw back is that it does not sharpen easily, or holds an edge.

D2 is a very good material for knives. It has one drawback though, and that it is rather brittle, but all these steels are easy to heat-treat and work.

# THE ADVANCE KNIFE MAKERS MANUAL

## ASIA D-2 HEAT TREATING PROCEDURE

1. Wrap blades in tool wrap. Double crimp all the folded edges being careful to avoid having even a pinhole in the foil. The blades may be wrapped individually or stacked side by side (stack no more than five or six per pack for ease of handling). If we wrap them individually, you may consider placing them in our optional furnace rack that will hold the blades in an upright position for reducing warping.
2. After placing the blades in the furnace heat to 1850° F. After reaching 1850° F immediately start timing the soak time of 15-20-minutes.
3. After the soak time has elapsed, carefully slide out the package on a steel grate or wire mesh for cooling in room temperature. (This is known as the air quenches).
4. While the blades are cooling, allow the furnace to cool down to 950° F.
5. When the package has cooled enough for handling, remove the foil. The blades should be warm (approx. 125° F). At this time place them back in the furnace at the 950 ° F temperature. After the blades have reached this temperature, allow them to remain (draw) for two hours.
6. Remove the blades for cooling down to room temperature and place them back in the furnace at 900 ° F again for two hours. (This is a double temper we suggest for D-2.)
7. After removing and cooled then check hardness. You should have 58/60 Rc. For extra stability and 1-point higher hardness, you may pack the blades in dry ice for one hour.

This is an oil-hardening grade of steel that will require oil quenching. The oil should be warm, thin quenching oil that contains a safe flash point. Olive oil has been used as a substitute. There should be a gallon of oil for each pound of steel. For warming the oil before quenching, you may heat a piece of steel and drop in the oil.

1. Wrap the blades in stainless tool wrap and leave an extra two inches on each end of the package. (This will be for handling purposes going into the quench as described below.) We suggest a double wrap for this grade. The edges of the foil should be double crimped being careful to avoid having even a pinhole in the wrap.
2. Place in the furnace and heat to 1900 ° F, after reaching this temperature immediately start timing the soak time of 25-30 minutes.
3. After the soak time has elapsed, very quickly and carefully pull the package out with tongs, place over the quench tank and snip the end of the package allowing the blades to drop in the oil. You should have a wire basket in the oil-quenching tank for raising and lowering the blades rather than have them lie still at the bottom. Gases are released while quenching and

## THE ADVANCE KNIFE MAKERS MANUAL

would form a trap around the steel unless you keep them moving for a minute or so.

**IMPORTANT** - it is very important that the blades enter the oil or quenching media as quickly as possible after leaving the furnace. Full hardness would not be reached if we have not followed this step.

1. After we quench the blades down to near room temperature, preferably around 125 ° F, they must reenter the furnace at 300 ° F. After they reach 300 ° F, allow them to remain for two hours.
2. Remove the blades and place them aside for room temperature cooling.
3. After they have cooled to room temperatures place them back in the furnace at 275 ° F for two hours. Remove and check the hardness and you should have approximately 60 Rc.
4. For extra stability and a point higher hardness, you may pack the blades in dry ice for one hour.

Now comes the most important part of heat-treating process and that is of tempering of the metal. We can temper Harden steel or make it softer and less brittle by reheating it to a predetermined temperature, this depends upon the nature of the steel, and its intended use. In tempering, I let the oven cool down to the temperature that I need to draw the temper.

When the tempering is done by the color method, the colors gauge the temper formed on the surface of the polished metal as the heat increases. The color method of gauging temperatures is not dependable, as the color is affected, to some extent, by the composition of the metal.

Tempilaq is a compound that you can buy, in any temperature range, to put on the metal. When it melts, you have the metal at the proper temperature. Having a temperature gauge to get the correct temperature is better.

After you have worked with a certain type of steel for a while, you can probably judge the correct temperature by the color. Polishing the metal to a bright finish is best so we can see the color clearly.

### DRAWING HARDNESS RANGE

430 degrees: Very pale yellow, extra file hard, dies, milling cutters, cut off tools.

440 degrees: Light Yellow, file hard, reamers, thread chasers, fly cutters, and hollow mills.

450 degrees: Pale straw yellow, profile cutters for milling machines, rolling dies, knurling

## THE ADVANCE KNIFE MAKERS MANUAL

tools.

460 degrees: Straw yellow, knife hard, swages.

470 degrees: Deep straw yellow.

480 degrees: Dark yellow, cutting dies.

490 degrees: Yellow brown, extra hard, taps, dies.

500 degrees: Brown yellow, thread dies for general work.

510 degrees: Spotted red brown.

520 degrees: Brown purple, hard.

530 degrees: Light purple.

540 degrees: Light purple.

550 degrees: Dark purple.

560 degrees: Full purple.

570 degrees: Dark blue, half-hard.

620 degrees: Blue gray, spring temper.

700 degrees: Very light blue gray, spring temper.

Using 01 for the blade stock, you can draw back the spine (back of the blade) to a temper of 700 degrees. This will make the blade tough, but will leave the cutting edge hard. D2 & 440C you cannot do this. This comes in handy if you are making thin blade folders.

After hardening, let the furnace cool down to the temperature that you want to temper the blades. Put them in the furnace and let the whole thing cool down.

# THE ADVANCE KNIFE MAKERS MANUAL

## TEMPERING SPRINGS

On springs, I do not use the furnace to draw the temper. After hardening, I flatten the spring on a belt sander. This cleans up the surface so I can see the color.

Take the butane torch, and with a small flame start from the back of the spring. Heat the spring slowly, watching the colors. When the colors go through the whole range and up to dark blue, slowly move it down the spring. You will see the color go from dark blue to a light blue gray. Move the flame just fast enough to get this color.

When you have done this, let the spring cool, polish it again and repeat the process again. In several years of spring making, I have had only three springs break. The springs that broke had been over heated, and had very coarse grain.

# THE ADVANCE KNIFE MAKERS MANUAL

## MAKING AN ELECTRIC HEAT-TREAT OVEN

The tools required for making an electric oven are usually found in your shop or garage. At a cost of about twenty to thirty dollars and in a few evenings, you can own an oven of which you can be proud.

The oven that you can make is capable of temperatures up to 1900 ° and, if equipped with both a pyrometer and power control, it can maintain near constant temperatures over this range.

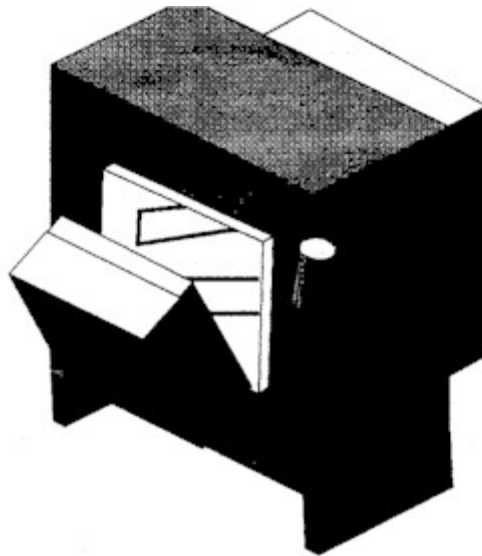

**THE ELECTRIC HEATTREAT FURNACE**

Once you have established the power setting that you need for a given temperature, setting up a time/power ratio is simple so you can duplicate the temperatures.

The power ratings for this oven, is based on the availability of heating elements, which we will use the electric elements for a 1000 watt oven. The heating element used is the type normally sold in appliance and electric supply stores. The heating element for appliances such as the cloths drier coil needs only to be stretched to the required length for use with this oven. It is made of Nichrome wire that offers resistance to current flow, thus producing the necessary heat. If the element does burn out, replacement is simple and a fraction of the cost of a commercial unit.

The oven can be used as for a heat-treating and tempering oven for steel tools, enameling and other similar applications. With imagination, you can find many other applications and uses for this piece of equipment.

Galvanized Iron Sheet, 26 Gauge

## THE ADVANCE KNIFE MAKERS MANUAL

- 1 Piece. 7 1/2 X 32 (Top & Sides)
- 1 Piece. 7 1/2 X 8 1/2 (Door)
- 1 Piece. 6 1/2 X 12 (Bottom)
- 1 Piece. 11 X 15 (Back Cover) (Light Gauge)
- 2 Piece. 2 X 3 1/4
- 5 Insulating Firebrick, 2300 ° F, 9 X 2 1/2 X 4 1/2
- 24 Round Head Sheet Metal Screws, #6 X 3/8
- 1 Piece. Asbestos Shingle or Sheet Asbestos, Approx. 2 X 6
- 2 Piece. Flat Steel, 1/8 X 1/2 X 6
- 1 Pint High Temperature Furnace Cement
- 1 Heating Element, Nichrome, Coiled, 1000 Watts at 110 Volts
- 1 Piece. Round Steel, 1 1/4 X 18
- 4 Brass Machine Screws, Round Head, 10-24 X 3/4
- 8 Hex Nuts, Brass, 10-24
- 1 Piece. Round Metal Stock, Any Material, 1 1/2"x 4 (For the Counterweight)
- 1 Heavy Duty Line Cord (Type Used on Electric Irons)
- 4 Machine Screws, Round Head, 6-32 X 1 1/4
- 4 Hex Nuts, 6-32
- 1 Power Control, Type C.r.s., Rated 1000 Watts (Minimum)
- 1 Pyrometer
- 1 Can, Heat Resistant Lacquer or Enamel

## THE ADVANCE KNIFE MAKERS MANUAL

You can begin construction by cutting the galvanized sheet, to the required dimensions given. We should now lay out the individual pieces for further cutting, folding and bending. You will note from the drawing details that I have shaded the areas that are to be removed. For neater looking corners, we have drilled 3 inch holes on centers at the intersections of the areas to be removed. These holes permit much easier bending and allow for the slight miss cutting of angles. Look at the metal layout details for dimensions and areas to be removed.

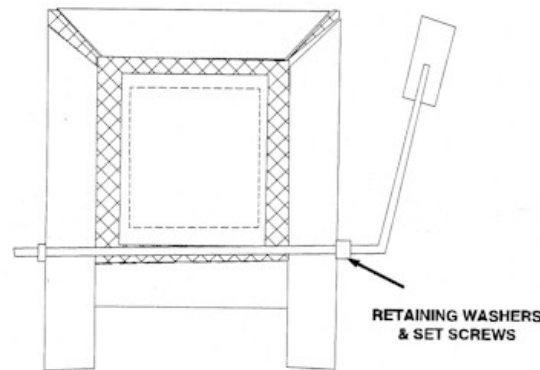

**FRONT VIEW OF FURNACE**

All pieces must be bent to 90 ° as shown by a "x" on the metal layout detail sketch. If you have a sheet metal shop in your town, it is better that we take it to the shop and let them do the bending.

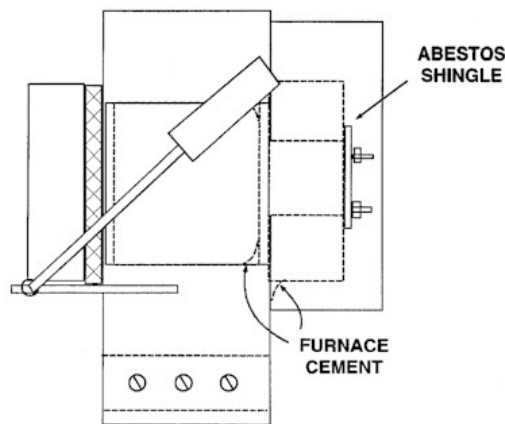

**SIDE VIEW OF ELECTRIC FURNACE**

If there is not a sheet metal shop in your town, clamping the pieces in a vise we can do the bending between two boards that are cut to the length needed. Bending the pieces with the above method is slightly more difficult, and they can achieve a neat bend with a little care.

The bending sequence should be well thought out before starting of any bends to avoid



# THE ADVANCE KNIFE MAKERS MANUAL

interference of one bend with another. This is all there is to the metal portion of the oven.

Next refer to the sketch titled, Furnace Layout. Two firebricks are left whole, we cut two bricks to 5" 1/2 inches long and we cut one brick exactly in half. You can make all cuts with a thin bladed backsaw. The two full-length bricks will be the top and bottom of the oven. The brick cut in half will furnish the two sides that have the heating element. The 5-1/2 inch bricks will be the door and the back of the oven.

This type of insulating firebrick is very soft and should be handled with care. A fingernail has sufficient hardness to gouge the brick. For this reason, and its high temperature properties, it was chosen for making this furnace. This type of insulating brick is normally used in some commercially made ovens.

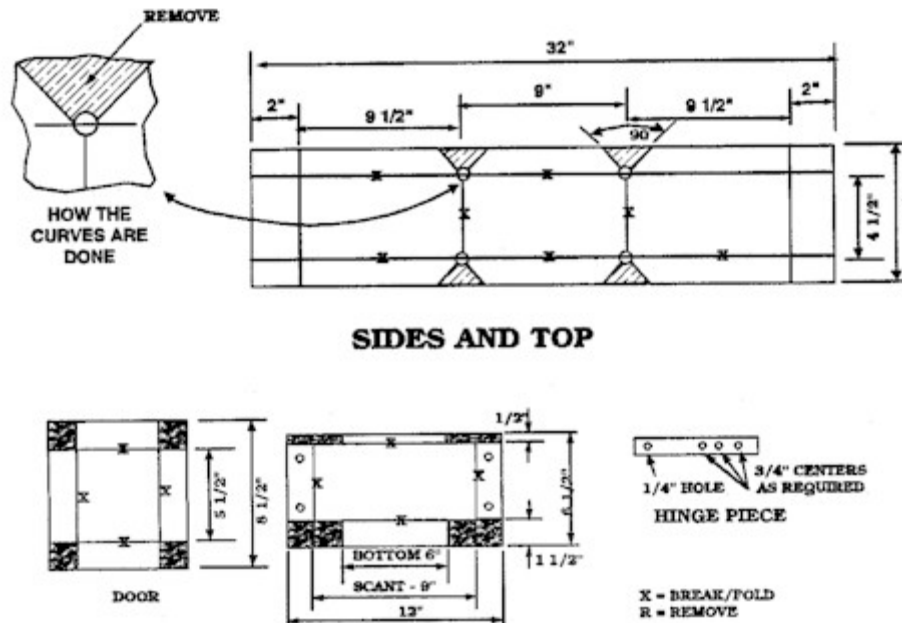

Several suppliers make this brick, and it can be bought in a suitable grade to withstand various temperatures. The 2300 ° F brick is sufficient for this type of furnace and should be specified as the type you want.

Take the two half bricks and looking at the coil layout, route the bricks so the heating elements will fit. The routed width should be slightly under the outside diameter of the Nichrome coil and sufficiently deep to contain the coil below the surface of the brick. The heating coil placement in the furnace is not critical, but should be close to the place shown in the drawings.

## THE DOOR

The door and back brick must also be routed to a depth of 3 inch along all four sides so part of the brick protrudes into the oven openings for better heat retention. This also can be done

## THE ADVANCE KNIFE MAKERS MANUAL

on a drill press using a flat-ended bit as a router or by carefully cutting and scraping away the excess material with a knife. Refer to the brick and coil drawing for the width of these cuts.

If you have a drill press or milling machine, the routing can be done by simply using a drill or router bit of the required diameter. We can carefully outline the coil layout on the brick in a soft pencil, the drill or router bit set to the required depth, and the brick pushed into the revolving bit, following the pencil outline. If you do not have a drill press, the routing can be done with a piece of round steel stock by pressing the end of the steel into the brick and using die rod as a scraper. This may seem difficult, but the brick is relatively soft and can be cut easily.

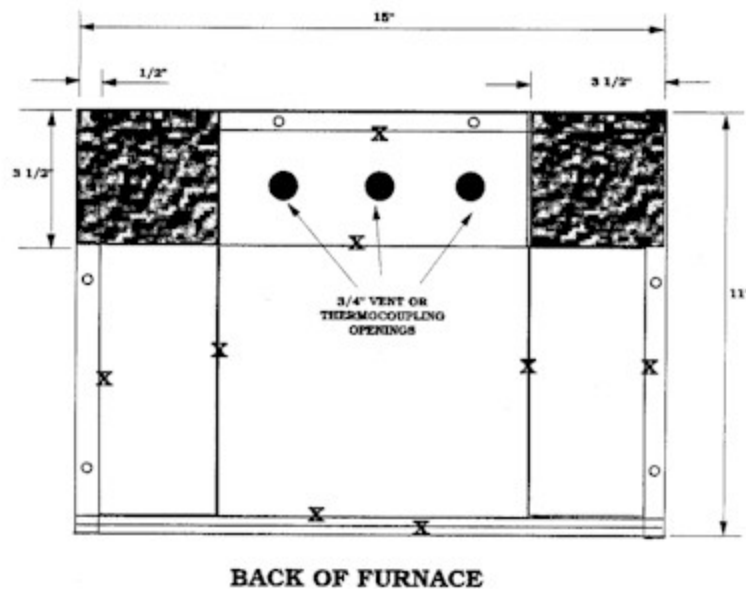

### HEATING COIL

Setting up the heating coil is next. Cut the coil exactly in half, this can be done by simply counting the number of coil loops and cutting it at the midpoint. At both ends of each coil half, if the coil must be straightened by stretching the coil loops out, so there is a 4-inch length of straight wire.

We will fasten the straightened ends to the terminal screws at the back of the oven. About 6 to 8 straightened coils are sufficient to produce the above length. The total length of the routing should now be determined and each coil stretched about one inch short of this length. Lay a yardstick on a flat tabletop, grasp both ends of one coil and stretch the coil using the yardstick as a guide.

# THE ADVANCE KNIFE MAKERS MANUAL

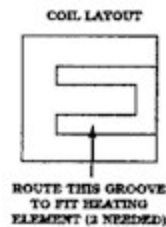
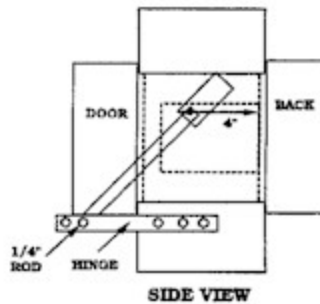
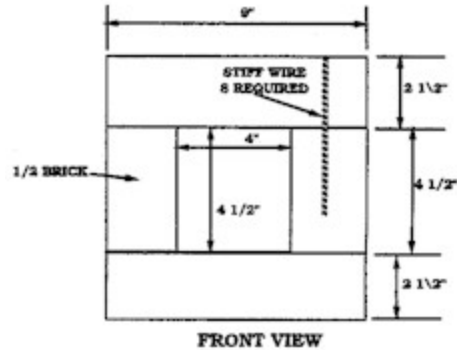

The amount to which the coils return should be the length needed as determined above. Starting 1/4 inch from the edge of the routed firebrick, press the coil into place. Get some staples 1/2 inch long with a radius of 1/16 inch and push these staples into the brick along the length of the Nichrome coil at points to hold the coil in place in locating the staples. Be sure they are pressed between the individual coils so as not to short out any adjacent coils. Once the Nichrome wire has been heated, it will take a permanent set. The use of the staples is to aid assembly.

## THE BOTTOM

Assemble the bottom, top and sides of the brick portion of the oven. Put one full brick on a solid flat surface. Then, position the two side bricks containing the heating elements flush with the front and side edges of the full brick and place the remaining full brick on the top of this assembly.

# THE ADVANCE KNIFE MAKERS MANUAL

Get some light, 4-inch pieces of stiff c inch diameter wire, and sharpened one end of each piece to a point. Drive two of these wires, as you would a nail, through each full brick into each side brick, both top and bottom.

The wires should be located through the full brick so they will be driven into the middle of the side brick one-inch from both the front and back edges of the assembly. You need the reinforcement of the bricks to hold them together for the assembly into the metal case. Drill pilot holes a little under the diameter of the wire used is drilled into the full brick. This will help in driving the wire into the side brick. When you predrill the holes, the wire is less apt to be driven into the sides at an angle. The firebrick is soft enough to accept the wires without breaking, if drive them in carefully.

## FITTING

When ready slip the completed brick assembly into the formed metal case. Turn the case containing the assembled bricks over so it rests on its top. Next, locate and drill two holes through the outside of the metal case. This should be one inch from the front and back edges of the oven, and centered with relation to the flange of the bottom piece.

We should put the bottom piece in position to check the locations where we should drill the holes. The holes should be the same size as the outside diameter of the sheet metal screws used. Now place the bottom piece in position again and locate the drilled holes on the side flanges of the bottom piece. When located, remove the bottom piece and drill holes the root diameter of the screw where you marked them. Assemble the bottom piece to the case using sheet metal screws.

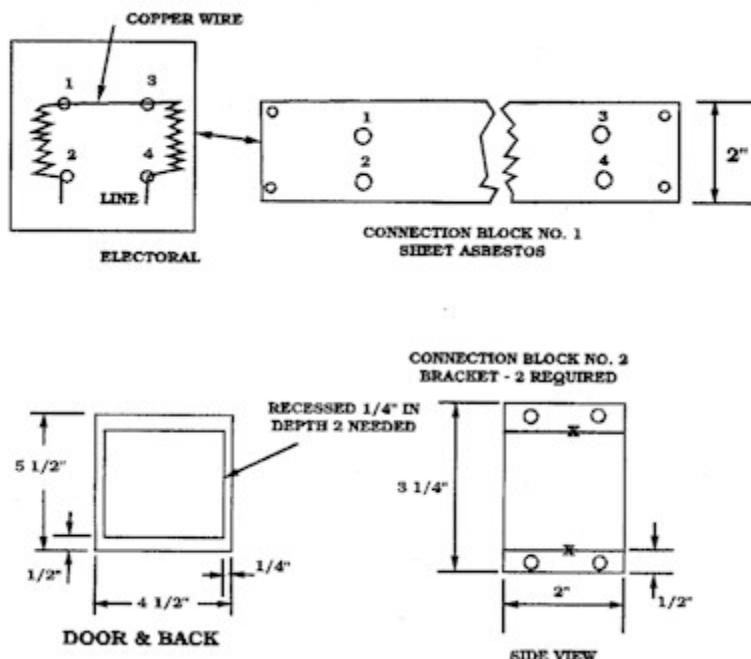

# THE ADVANCE KNIFE MAKERS MANUAL

## PUTTING TOGETHER

Sheet metal screws are self-tapping so to fasten two pieces of light gauge metal. The outer piece of metal is drilled to the outside diameter of the sheet metal screw and the inner piece drilled to the root diameter of the screw. By drilling the holes this way the sheet metal screw will bring the two pieces together and hold them tightly.

Take the two pieces of 2 x 3 1/2 inch sheet metal and bend them into a bracket for the terminal board. Bend an 1/2-inch flange on each 2-inch end in the directions indicated by the side view of the sketch. Drill the foot of the flanges for sheet metal screws and the tops to take 632 machine screws.

Locate the foot holes on the sheet metal on the back of the oven so the bracket will just clear the back brick. These brackets and the terminal board form the clamp to hold the brick in place. Fasten the brackets in place with sheet metal screws.

Cut and prepare the asbestos shingle and attach it to the brackets using the four, 6-32 machine screws. The asbestos can be broken successfully if it is first scored deeply with a scratch awl, and then snapped over a sharp edge. The asbestos sheet is the type normally used as siding to protect wooden structures. Before assembling the asbestos to the bracket pieces, drill four holes into the asbestos to accept the brass machine screws that will be the electrical terminal posts for both the Nichrome wire elements and the line cord. (See illustration.)

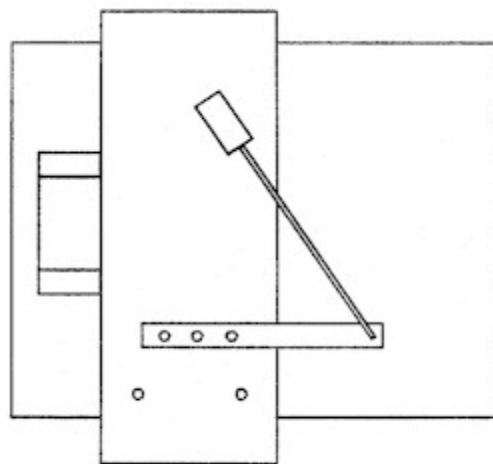

**SIDE VIEW DOOR HINGE**

The brass machine screws should now be inserted and the hex nuts tightened. Next, remove this assembly, place the back brick into position and reassemble. Be careful so you do not disturb the Nichrome wire leads, as each Nichrome wire lead should reach one of the brass terminal posts.

# THE ADVANCE KNIFE MAKERS MANUAL

## FILLETING THE BRICK

We should fillet all the firebricks on the inside with a high temperature furnace cement; this is done by spreading a fillet of cement with the tip of the finger to form a 1/4-inch fillet radius.

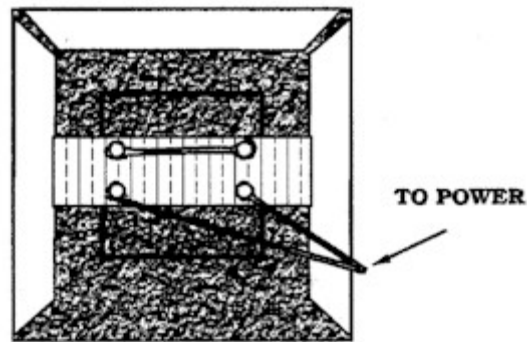

**REAR OF OVEN WITH  
BACKCOVER REMOVED**

Place the metal door piece face down on an insulated surface. We can position and weld the 1/4 inch steel rod or brassed in the correct position. The end of the rod should extend three inches beyond the width of the door and should be flush with the face of the door.

Use clamps to hold the door piece down against the insulated surface to prevent warping during welding or brassing. About 1-inch area at each edge of the door and rod contact points, are all that is necessary to hold the door securely to the rod. Bending the rod now is not necessary, but when ready the door handle can be either to the left or to the right of the oven.

Position the oven between two bricks placed at the top and bottom of the oven so the oven is level and we hold the back bracket above the working, surfaces of a workbench.

## MOUNTING THE DOOR

Take the front door firebrick, place it into the metal door piece, and center this assembly on the oven with relation to the oven opening. Now drill 1/4-inch holes into the hinge bracket piece. These hole, should be centered and 1/2 inch from the end of each piece, and from the opposite end, drill three holes on 3/4 inch centers to accept sheet metal screws.

## THE ADVANCE KNIFE MAKERS MANUAL

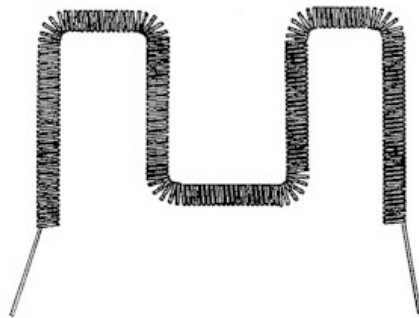
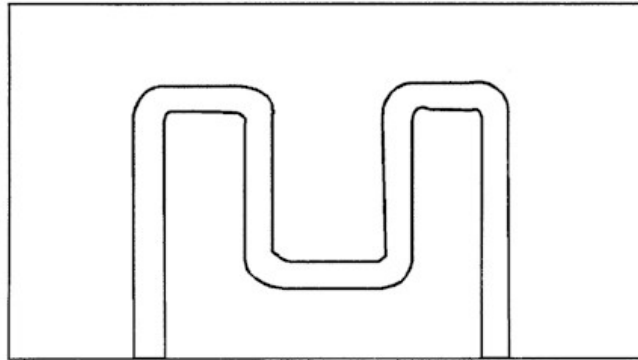

THE HALF BRICKS (TOP) ARE WHAT FORMS THE SIDES OF THE OVEN. THE BRICK IS ROUTED OUT TO TAKE THE HEATING COIL. THE HEATING COIL SHAPED TO FIT THE ROUTED AREA.

Set the two bracket pieces on the positioned door rod and locate the three screw holes on the sides of the metal case. Drill holes in the case to the root diameter of the sheet metal screws and assemble. The door can be opened and closed now to check any points of binding. If you have binding points, they can be relieved by further cutting away the firebrick.

Take two 1/4 inch retaining collars should be used to keep the hinge rod from sliding back and forth. The retaining collars can be 1/4 x 20 hex nuts drilled to a full 1/4-inch opening. Take one of the hex nut faces on each nut, drill, and tap them to accept a setscrew. Put the retaining collars on the rod, with one on each side of the hinge bracket, and center the door, position and tighten the collars in place.

Use a gas torch with a small flame to bend the rod, at a point, 2 inches from the hinge bracket. Heat the hinge rod to a cherry red and bend the rod up toward the top of the oven at an angle slightly less than 90°. This rod also should be bent back about 35° in relation to the front face of the oven.

Finish the counterweight by drilling an 1/4-inch diameter hole to a depth of about 2 inches. The counterweight can be made of any round stock with sufficient weight to hold the door tightly closed. The counter weight can be secured to the end of the rod by epoxy glue or a setscrew.

# THE ADVANCE KNIFE MAKERS MANUAL

## FINISHING UP

Now to the back of the oven, attach one Nichrome wire lead to each of the four brass terminals screws. Attached across the two upper screws, a piece of heavy gauge copper wire that acts as a jumper to give continuity to the two heating elements.

On the bottom two brass terminals, attach the heavy-duty line cord. Position and fasten the back cover using the remaining sheet metal screws. This will complete the oven assembly except for painting. Use aerosol wrinkled finish paint in either black or gray to give the oven a professional finish.

In mounting a pyrometer, the vent holes in the back cover can be used to pass the thermocouples through to the back firebrick and into the oven chamber. Mount the pyrometer on top the oven, and a silicone controlled power rectifier of the proper wattage can be used with this oven. By controlling the input of current, you can achieve an infinite range of heat adjustment over the range of the 1000-watt model.

Leftover firebrick pieces can be cut into slices 1 inch thick and used to set your tools on.



# THE ADVANCE KNIFE MAKERS MANUAL

## THE GAS FORGING & HEAT TREAT FURNACE

A gas furnace for heating materials in your shop is one of the handiest pieces of equipment that you can own. With a gas furnace, you can get the necessary heat so you can heat, shape and forge all type of metal objects.

My gas furnace has been indispensable in my small shop for years. I could make small metal parts and then heat-treat or case hardened them with this furnace. You can change this furnace to about any shape and size that you need moreover makes an excellent blacksmith furnace.

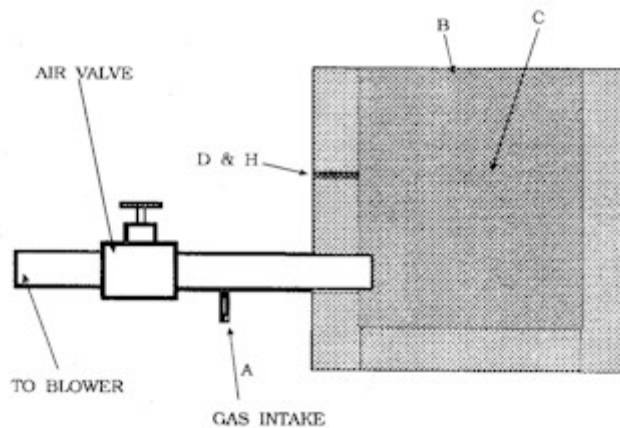

**FURNACE AND GAS VALVE**

It will not get hot enough to weld metal but you can do all of the forging with it. I will show you through drawings how to make a top loading and a front-loading furnace. Remember if you need a special size, changing the dimensions for any size that you need will be simple.

If you go to a larger furnace, you may need to run an additional fuel/air pipe to get the increased heat. By using pure oxygen on the air intake of the blower, you can increase the temperature somewhat.

A-Gas/Air outlet; B-Furnace opening; C- Side view; D-Opening for temperature sensor; E-Blower; F-Gas intake; G-Heat sensor pipe; H-Heat sensor opening.

We can make the gas furnace in about a day depending on the size, and usually everything that you will need can be found locally. I will cover in this article how to make a top loading gas furnace, and depending on the size, by scrounging you can probably make one for well under \$100.00.

The furnace for the top loader is easy to make. You will need eight firebricks to make this furnace depending on the size. When completed, you will have a furnace with an inside

## THE ADVANCE KNIFE MAKERS MANUAL

measurement of about four 1/2 by three by eight inches. This size will handle most any small jobs that you may want to do and it is an excellent furnace for heat-treating knife blades.

The first item you will need is some mortar cement that most hardware stores carries for wood burning stoves. Another source is a business that sells fireplaces and wood burning stoves. You will need eight standard size firebricks (9 X 4 X 2 inches) to build this furnace, and the above businesses should carry these.

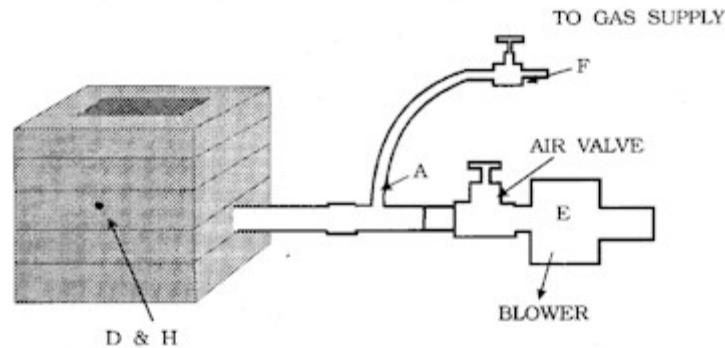

**COMPLETED HEATTREAT FURNACE**

You will need several pieces of threaded one-inch iron pipe and a two-inch valve that will be used to shut down the air/gas mixer. You also will need some two-inch pipe, also a reducer to go from two inches to a one-inch pipe. The drawings are self-explanatory on hooking up all the plumbing so there should not be any problem there.

### LIST OF MATERIALS

1. A high volume blower.
2. 2 inch to 1-inch pipe reducer or hose.
3. A 2-inch valve.
4. 1/2 inch needle valve for controlling gas flow and a high-pressure hose for connecting to a Propane bottle.
5. Several pieces of one and two-inch pipe, depending on your setup. Wait until you get everything made and set up before buying these.
6. Brick mortar.
7. Fire Brick, quantity will vary according to the size of your furnace.

## THE ADVANCE KNIFE MAKERS MANUAL

8. A high temperature gauge (2000 degrees).
9. A temperature sensor.
10. A small pipe that the sensor will fit in.
11. 3 inch pipe for gas valve and mixer.
12. Propane tank.
13. A 4-inch round flat metal for mounting on a blower to regulate airflow.
14. A light dimmer switch for regulating blower speed.
15. Electrical wires as needed.
16. A bottle of Tempilaq for the temperatures needed, this will eliminate the need for number 8 and 9 of the above.

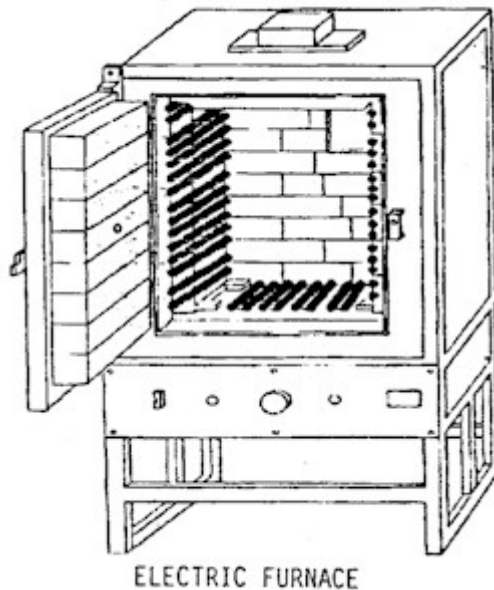

A high volume blower such as is found on vacuum cleaner, is necessary for the high volume airflow. This can be located, and bought used from a vacuum cleaner business, or you might even have an old one lying around in your garage.

You should also have a metal table with a metal plate on top of it the size of your furnace to build the furnace on and to help protect the table from the heat. Once you have your bricks and mortar, you can start building this furnace. If you have a well-ventilated building or

# THE ADVANCE KNIFE MAKERS MANUAL

garage you can operate this furnace there but be careful that you have no combustible materials overhead.

I do want to warn you that this furnace produces lots of heat, so it should not be placed near any type of combustibility material. Keep plenty of space between it and the wall. The fuel that you will use is propane and the propane bottle as the ones that is found on barbecues can be used to operate your furnace.

## BUILDING YOUR FURNACE

Set up your metal table with the metal plate on it, at the location you plan to build the furnace. Start with bricks (See Figure 1 & 2) for the bottom and mortar the firebricks with the cement that you bought. You place two of the bricks flat, side by side on the metal table. We should mortar these bricks together when you set them on the table. Two more bricks are then placed on the first two that are lying flat. These two and the others are mortared together on their edge. Let it set over night before doing any additional work on it.

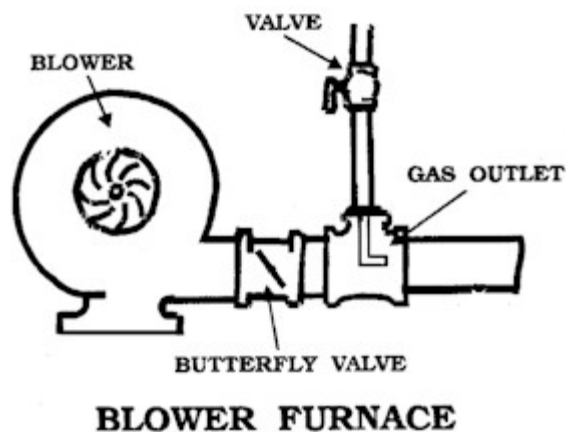

The next thing you must get is a cement drill that is slightly larger than the pipe that you are using from your hardware store. With this drill, you will drill one hole 2 inch above the base in the center of the furnace. This is where we will insert the one-inch pipe from the blower. There are many ways of hooking up the plumbing, so you will need to buy the correct length pipe after getting everything assembled.

The furnace that I am and describing is a top-loading furnace, which means that we hang the parts from the top using stainless steel wire. If you decide to build a front-loading furnace, you will need a three or five-inch opening depending on the size in the top of the furnace for the gas to escape.

When you hook the blower to the two-inch pipe, you will need a pipe reducer or a flexible hose and two hose clamps to attach the hose to the pipes.

## THE ADVANCE KNIFE MAKERS MANUAL

The rest of the connections can be done as shown in the drawings. We mount a round adjustable flap on the intake side of the blower to regulate how much air that it will produce.

### THE TEMPERATURE GAUGE

A high temperature gauge can be purchase from an industrial supply dealer if you want to control the temperature precisely. You can also buy from Gunsmith suppliers a temperature indicator called Tempilaq. It comes in many temperature ranges so you can buy a bottle of this for the temperature that you need.

To use Tempilaq, paint some on the metal and let it dry. When you put in the furnace watch it closely as the temperature rises. When the temperature of the metal reaches the temperature of the Tempilaq, it will melt the Tempilaq. At this point the part is ready to come out of the furnace or you can reduce the air/gas mixture to maintain this temperature.

If you want a high temperature gauge, we can buy this from an industrial supply business. You will need to have one at will reach 2000 degrees so there will be a safety margin for the gauge. You will also need a thermocouple that will be attached to the gauge, and the head of the thermocouple will be inside the furnace.

Get a large enough cement drill to drill a hole through the fire brick about two inches from the top if you have a top-loading furnace. The thermocouple will fit inside a short length of iron pipe that is large enough on the ID to allow the thermocouple to fit. We then mortar this pipe in place in the furnace.

By following the above instructions and the drawings that we include, you can build you a furnace that will have many uses. If you want to build a front-loading furnace that is larger than the one that I am describing. You will need to support the bricks as shown in the drawing on the front-loading furnace.

### LARGER FURNACES

What I do on larger furnaces for the additional support and strength of the roof bricks is to buy a long length of 1/2-inch rod from the hardware store. I cut out the necessary number of pieces four inches long to provide the support for the firebrick on the top of the furnace. I use a 1/2 cement drill to drill the holes in the end of the bricks.

I then insert the 1/2-inch rod into the hole that has mortar inside it, and then I will take the brick with the corresponding hole, apply mortar to it and put the two together. This is done on the flat floor, and then I let it set up over night.

While this is setting up, you can start cementing and setting the bottom of the furnace bricks. Once they are in place, start cementing the sides and the ends of the furnace. Be careful

## THE ADVANCE KNIFE MAKERS MANUAL

when you set the sides and the ends in place so that the tops of the bricks are even.

The next day, mix up some more mortar and put the top bricks in place, being very careful that they all fit together snugly. After you get the top mortared and put in place, let the furnace dry over night.

Now you need to drill the vent hole in the top part of the furnace. Now drill the three or five-inch hole (depending on the size of the furnace) in the top of the furnace. I have found that if you take an 1/2-inch cement drill you can make a circle in the bricks. To do this, mark a circle out on top of the bricks in the location where you want the hole.

With the 1/2 inch cement drill and electric drill, start drilling the holes all the way through the bricks, about 1 inch from the edge of the last hole. When you get all the holes drilled, you take a thin chisel and break the thin edges between the drilled holes.

Once they are broke loose, we can remove the center plug. I have even used the cement drill on the angle to cut those connecting ridges along with chiseling.

After you get the gas vent done, you will need to get a cement drill slightly larger than the blower pipes. We will drill the blower pipe hole in the sides of the furnace so that the bottom of the pipe is about 2 inch above the bottom. You have to watch where you put these pipes so that they will provide equal heat on the front and back and the center of the furnace.

When you finish drilling these holes, take two, one-inch (depending on the size) pipes that should be about six inches long, and place them in the holes you have drilled. They should extend through the holes on the inside of the furnace about 2 inch.

Once you have those pipes in place, you can take measurements and by the necessary elbows and pipes to finish the job. This is why I said previously that you should not buy the pipe and fittings until you have finished the furnace body. The gas/air pipes that you have placed in the holes in the side of the furnace should be mortared in place.

Usually, we will make this furnace to the size for what type of work for which we intend it to be used. After you have connected all the plumbing, you will need to connect the blower to the unit. I have found that an old radiator hose makes an excellent hose for connecting the blower pipes.

We can buy the air flap that you put on your intake opening on the blower at your hardware store. It is a cover plate for electrical boxes the metal type. You drill a hole in it at the top the size of the screw you are going to use. Next, holding it in place on the blower drill, tap the hole in the blower housing. There are two ways to attach the flap; one is to just screw the flap in place. The second way is to run a screw through the tapped hole and use a wing nut and washer to hold the flap in place.

About all that is left, to do is drill your hole for the heat sensors if you plan to use one. If you

## THE ADVANCE KNIFE MAKERS MANUAL

have a welder, you can finish the furnace out by enclosing it in metal. All you need to do is cut some c and metal plate to the size that you need for the sides, ends, and top. They can all be welded together so that the furnace will look neater. You can even make a door for the front of the furnace, which is handy for annealing metal. If you make a door for the front, be sure to use firebrick that will fit the opening of the furnace. The firebricks are attached to the metal door with long screws.

When lighting the furnace the first time be sure to shut the airflow way down. Leave the gas shut off until you have the air adjusted, and then slowly turn on the gas, while holding a lit Butane torch over the opening of the furnace. Once lit, more than likely there will be quite a bit of flame coming from the opening. If this happens, slowly increase the airflow until the furnace roars and produces a blue flame.

Once you have the flame adjusted, you probably will not need to adjust it again. You can also use a room dimmer switch to slow and adjust the blower. The flame from this furnace is very hot and will heat steel to a yellow heat necessary for forging.

The plumbing will be about the same for any type of furnace you will build. The pipe sizes may be larger on the bigger furnaces. If you have any doubt on the pipe sizes, go to the next larger size, as the fuel/air mixtures can be fine tuned for the larger sizes.

**BE VERY CAREFUL WHEN LIGHTING THE FURNACE.** We assume no responsibility for accidents.

## GETTING STARTED MAKING A KNIFE

### TEMPLATES

First, decide what kind of knife you want to build, or use a factory knife pattern to make your knife. First, if you want to use your own design you will need to draw the knife design to actual size. When you design a folder, you always start with the blade first, and sketch this out on thin cardboard. Estimate the location of the pivot hole (refer to the drawing) and use a compass to draw a small circle around this point. The circle should have about a half-inch a 1/4-inch radius.

After making a copy of it, take a piece of thin aluminum, brass, or 1/16-inch tool steel sheet, the tool steel is better to use for making the templates as it last longer. When you get the parts cut out and fitted, you can harden it. Get some rubber cement and glue the pattern to the metal. When dry go to the band saw and very carefully cut out each pattern. Take a file and go over it to smooth out the band saw marks.

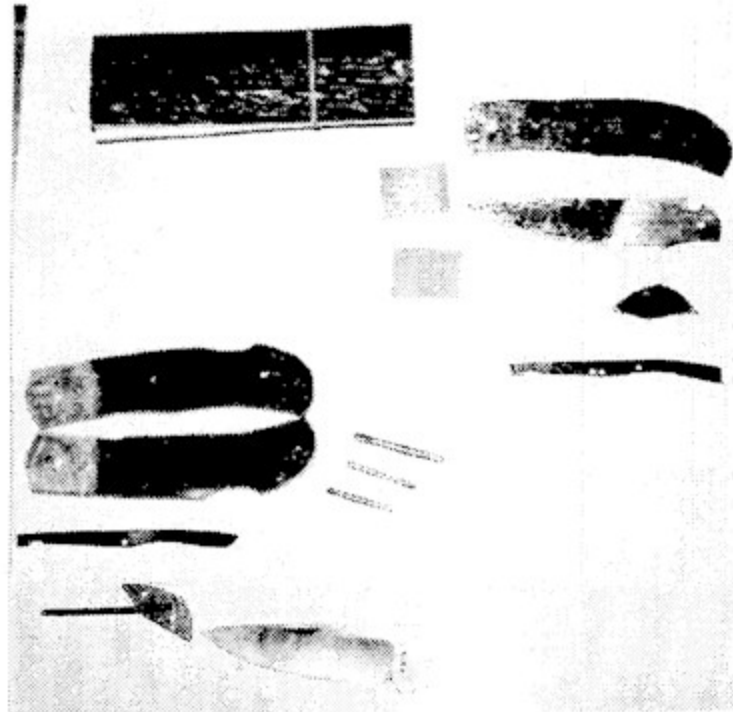

*TEMPLATES & FINISHED PARTS*

Carefully, center punch where the holes are and drill them. The main hinge pinhole is c inch, and the others are 3/32 inch. Slightly countersink these holes to remove any burrs. If you are working with a lock back, take the blade template, and with a narrow file true up the locking notch. The notch should have a very slight angle at the back so the lock will keep tight through use. If we cut the notch square, there will be slack in it when used for a while.



## THE ADVANCE KNIFE MAKERS MANUAL

Take the lock, and file the front square, (the part that goes in the blade notch). Carefully hold the lock against the front of the lock on the blade and check the angle of lock and blade. The blade and lock should blend in at the same angle.

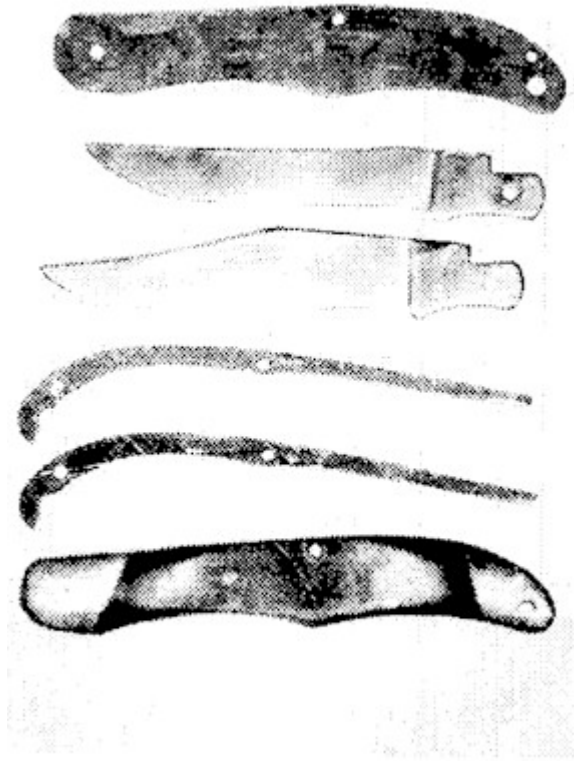

**USING FACTORY KNIFE AS PATTERN**

The blade should not stick up or point down. When you have this angle right, very carefully fit the back of the lock so it fits exactly in the lock of the blade. When the blade and the lock fit right, the top of the blade and the lock should be flush.

The spring retainer is cut out and filed like the other parts. The groove where the spring goes needs to be filed to a width of  $\frac{3}{32}$  inch; this is the usual size for most springs, unless you go into a bigger knife.

After getting all the patterns filed out, put the pattern back on the template. Now take a center punch and mark the templates where we should drill the hole. Drill all the holes  $\frac{3}{32}$ -inch except the larger blades. These should be drilled  $\frac{1}{2}$  inch.

The template for the liner is done the same. However, the only hole that you use is the hinge hole. We drill the other holes as you fit the parts.

## THE ADVANCE KNIFE MAKERS MANUAL

The exception to this rule is when you are making spring back knives. You drill all the holes, including the liner.

There are two different ways to do this. 1- Use the heat-treating furnace, 2-use a torch. If you use a torch, heat both sides evenly. When the template gets to a cherry red, quench straight down into the quenching oil.

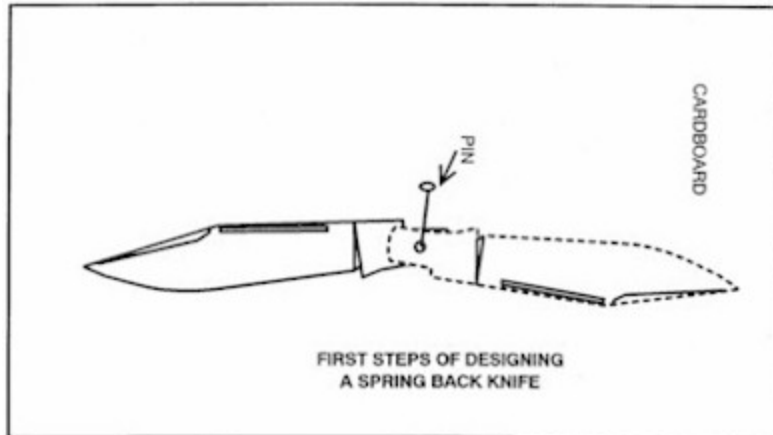

Going straight into the oil is very important. If you quench on an angle, the templates will warp. After hardening the templates, polish one side good. Take a butane torch and slowly heat the part. When you start to see some color in the metal be careful, as you want to get the color a straw color. Let it cool and the template is ready to cool.

Take a piece of tool steel the thickness that you want the blade and lock made from. Usually knives with blades less than two 1/2 inches you use 3/32 inch. Blades more than two 1/2 inches long use 1/8-inch stock.

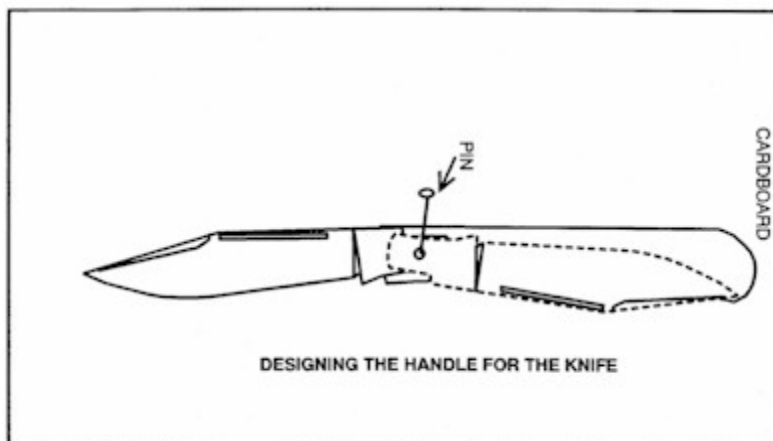

Wipe any grease or oil off the tool steel. Give it a good coating of layout fluid, or Dykem. We put this on so you can see the scribe mark that you use to mark out the pattern. Lay the blade template on the tool steel stock. Hold it down good, or use a clamp so it does not

## THE ADVANCE KNIFE MAKERS MANUAL

move. Take a very sharp scribe or a heavy needle and mark around the template. Repeat the process with the other parts. You can use brass or tool steel for the handle template.

Once we mark out the parts, they are ready to cut out on the band saw. Make sure that the band saw is running at a slow speed.

Do not try to cut the steel at wood cutting speeds. The teeth of the band saw blade would burn off. Carefully follow the lines that we marked on the tool steel.

Cut out each piece for the knife, leaving a .032 or so on the outside edge of all the pieces that you cut. Leave at least 3/32 extra in the kick area, which will be fitted later. This will insure that all the parts will be flush when we grind down the outside edge.

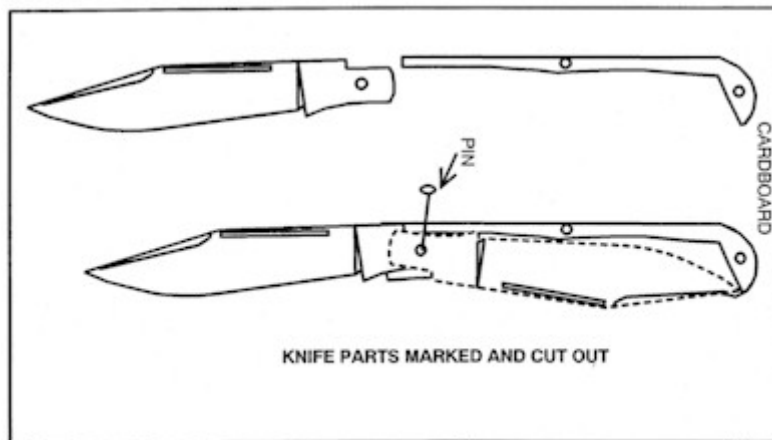

Take the template for the blade, and center it on the blade blank. Use a small C clamp and clamp the template to the blank. Go to the drill press and get the correct size drill bit. Drill through the hole in the template, and through the blank, and put a line up pin, or the drill bit in the hole you just drilled.

**NOTE**-After getting the fitting done, use a drill bit that is 3-4 thousands larger than the pin you will put the knife together with. This insures that the blade will not bind in the hole in the blade.

## THE ADVANCE KNIFE MAKERS MANUAL

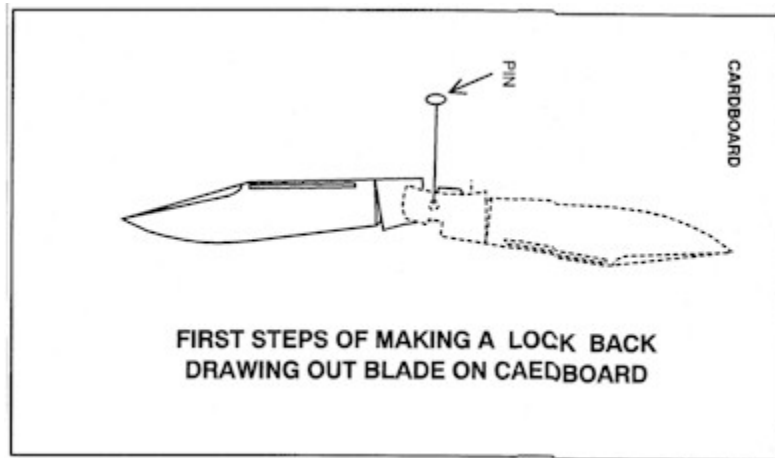

Clamp the blade and template in the vise. With a flat file, carefully file the blade blank down to the template. The only part of the blade that needs to be fitted is around the pin, and on a lock back, the notch, and the radius behind the pin. The area of the kick, cutting edge, etc. does not need to be taken down now.

The blade lock (if making a lock back, spring if making a spring back) is carefully centered to the lock template. Then we clamp it, and drill the pin hole, once the pinhole is drilled, stick a pin in the hole to keep everything lined up. Clamp the lock and template in the vise, and carefully file the lock down to the template. Remember that we harden the template, and it will take the edge off the file. Just file the blank down to where the file just hits the template.

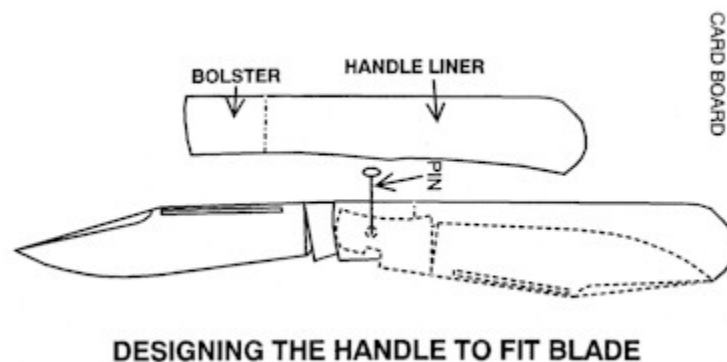

The final fitting is done with the blade blank. Set the lock in the blade blank lock notch, and see how well it fits but more than likely you will take more off the back of the notch. File, fit, and check until you have it most of the way down, but not all the way.

Clamp the blade blank in the vise, set the lock in the notch, then take a small hammer, and seat the lock the rest of the way. When you seat the lock, make sure that the lock stays straight with the blade. Seating the lock in this way assures you that you have a good fit. We should seat the lock and blade firmly together now, and for now leave them together.

## THE ADVANCE KNIFE MAKERS MANUAL

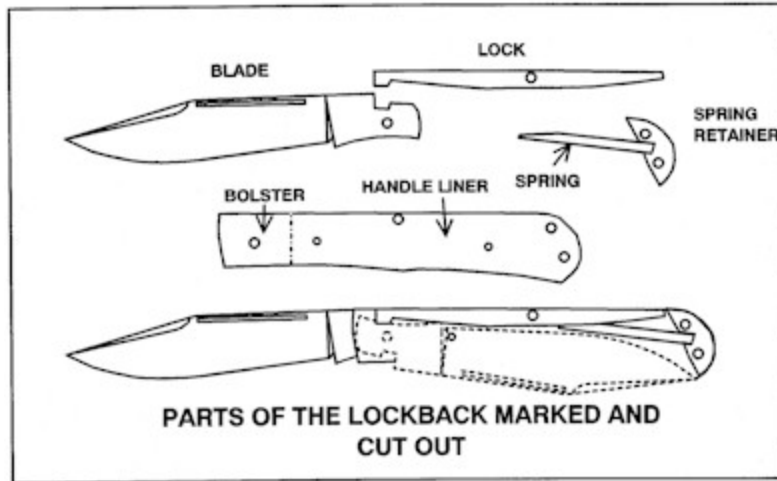

Usually you will use 1/32 material for the liner. Lay the handle template on the stock, mark it out, and cut it. When done clamp the pieces together, and file or sand them all to the same size.

The bolster is next. For most lock backs, and larger spring backs, make the front bolster 1 inch long. This adds strength to the knife. On smaller knives, we cut the bolster lengths for both ends one inch long. If you are making a larger knife, mark a line all the way across a piece of one inch thick nickel silver, or brass. Take the liner where the bolster goes and mark the width on the sheet of nickel silver or brass.

Once the width is set, band saw the bolster stock out. Once they are all cut, go to the table sander and sand one side flat. We will solder this side to the liner. Set the round disk sander table (on the belt sander), to 45 degrees. This angle will lock the handle material to the bolster.

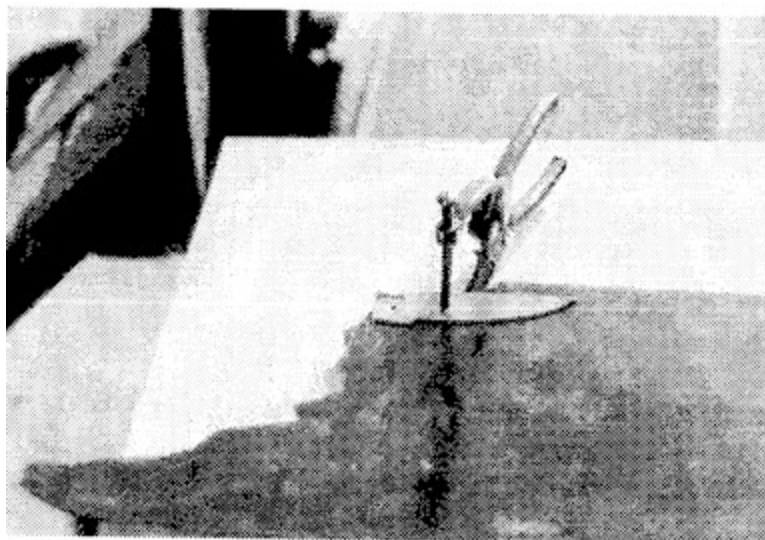

MARKING OUT PATTERN

## THE ADVANCE KNIFE MAKERS MANUAL

Turn on the sander and carefully press the edge of the bolster against the sander disk. This will cut the 45-degree angle. Have a pan of water handy, as the bolster gets hot fast. Grind for five to ten seconds, and dip the part. Keep doing this until the edge becomes sharp. Finish the rest of the bolsters and we will sweat them to the liner. The instructions here are for a bolster on one end.

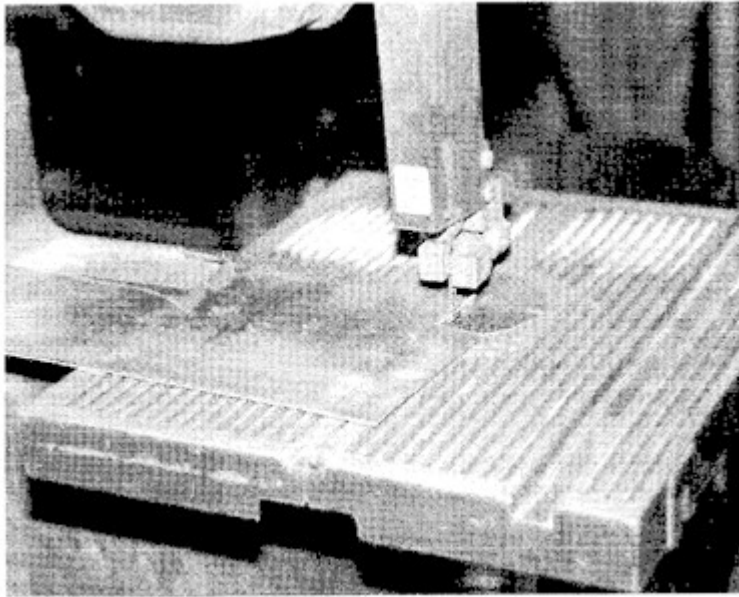

SAWING OUT KNIFE PARTS

You will need to get some powdered plumber solder from your local plumbing shop. This solder has the flux in it already, which makes it very simple to use. I have used other methods of applying solder, but this is the best and the quickest.

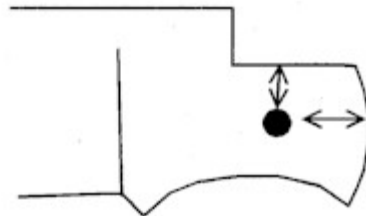

LOCATION OF PIN HOLE IN BLADE

Take a ruler and holding the edge on the topside of the liner, mark one inch. If you have a thin metal ruler, hold it so it measures one inch, and being sure it is flush with the top of the liner. Let me explain further. Holding the liner flat, and lay the ruler on it, flushing the edge of the ruler, to the top edge of the liner. Take a flat piece of cinch brass, lay it on the liner, flush it against the end of the ruler, and clamp it in this position.

Apply a very thin layer of powdered solder over the entire surface where the bolster will be.



## THE ADVANCE KNIFE MAKERS MANUAL

Take one of the bolsters, and lay it on the liner with the 45-degree angle flush against the piece of brass. Clamp this in place. Remove the clamp that holds the brass on the liner, and put the piece of brass back for later use.

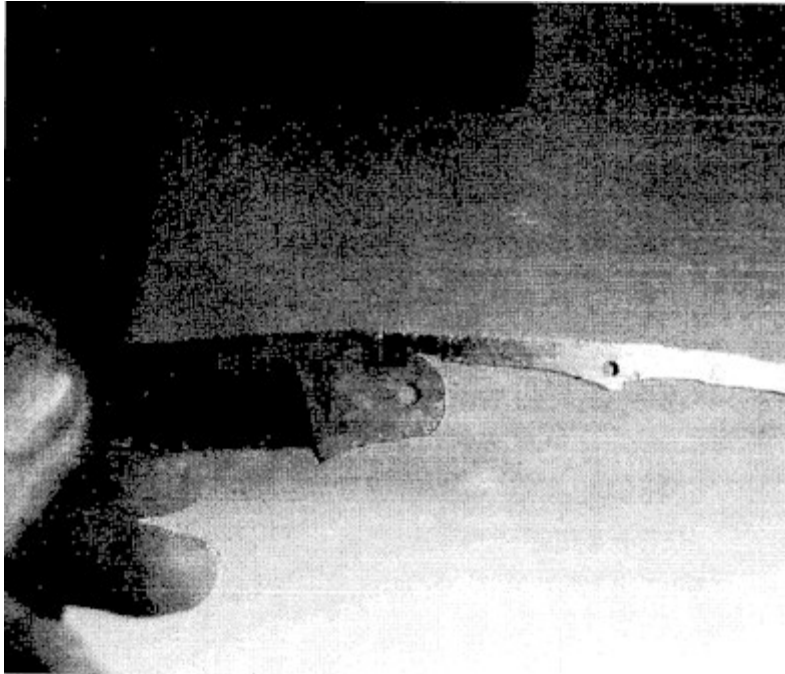

LOCK FITTED TO BLADE

Clamp the liner in the vise, and get a butane torch and heat the bolster until the solder melts, and the flux turns a dark brown. Turn off the torch, and quench the soldered liner/bolster in a pan of water. This removes most of the solder flux.

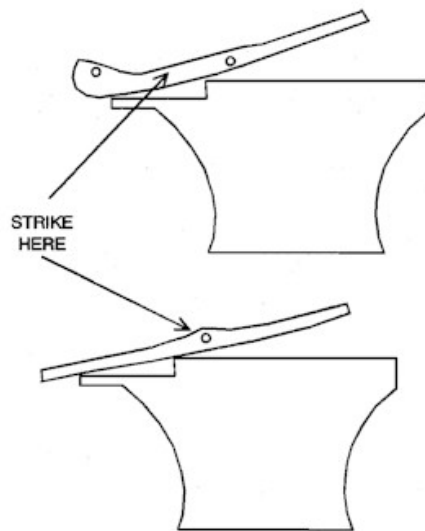

ADDING TENSION TO A SPRING

## THE ADVANCE KNIFE MAKERS MANUAL

Repeat the operation on the other liner, making sure that we line both bolsters up the same. Look for any puddles of solder on the 45-degree angle. If you do see these, scrape or file this off, as it will interfere with the fitting of the handle.

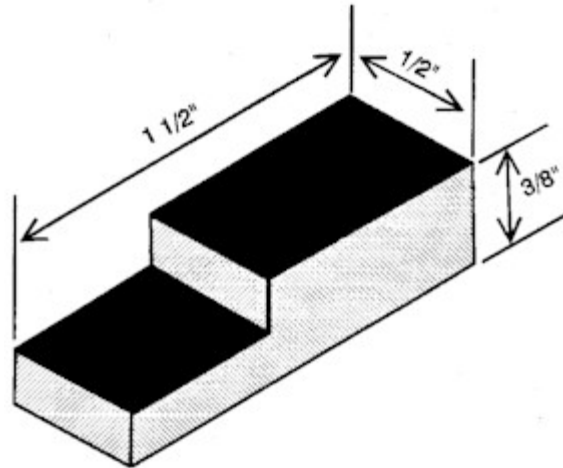

CRINKING BLOCK

If you are using rear bolsters, now is the time to attach them. On these, you will fit the handle material first. To do this, mark and cut out two pieces of Micarta or Pakawood. Have enough material around the sides so it will not be too hard to fit on the first knife.

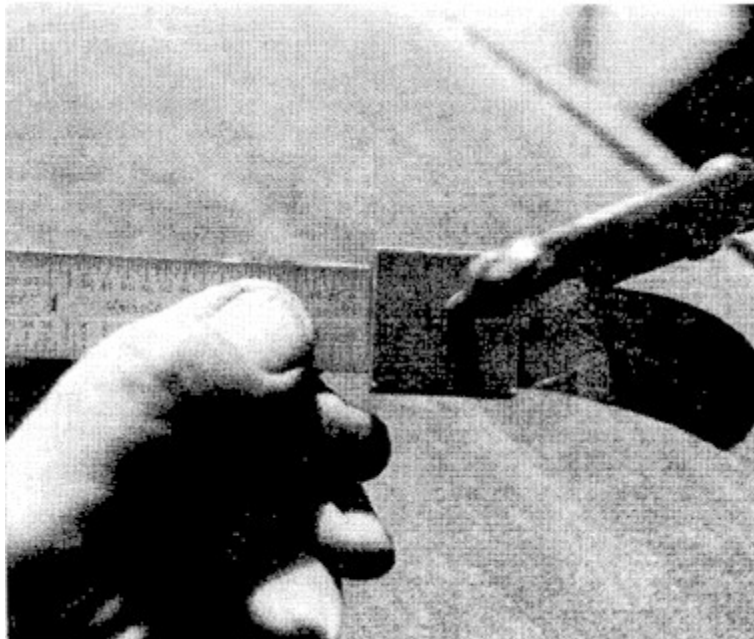

MEASURING LINER FOR BOLSTER

Go to the belt sander, and on the sanding disk, grind a 45-degree angle on the bolster material.



## THE ADVANCE KNIFE MAKERS MANUAL

Flatten the bottom side of this material on the belt sander. We need this to assure that the material will lie flat on the liner.



GRINDING THE 45 DEGREE ANGLE ON BOLSTER

Set the handle in place, against the 45-degree angle on the bolster. It should rest flush against the bolster, with no gaps. If everything is OK, clamp the handle in place on the liner. Turn the handle over so the underside will be up. Take one bolster that you have for the rear, and set it in place on the bottom side of the liner. Holding it in place, take a pencil and mark a dot on the handle material.

This should be on each side, and on the undercut of the bolster. To explain a little further, you take the handle material from the liner. Take a small ruler, holding it in line with the two dots, and draw a straight line from one dot to the other. The back end of this material is then band sawed off. Take this piece to the Disk sander and cut a 45-degree angle on the end that you cut off.

If you did everything right, you can probably clamp the handle material on the liner, and check for fit. With the handle materials in place, set the rear bolster in place, and check how much it is sticking over the liner. It should not be sticking more than 1/16 inch. If it is, take off a little more from the end of the handle. Try it again, and if it is OK, you can solder the rear bolster in place.

Put some plumbing solder on the liner, where the bolster will go. Carefully hold the bolster in place, and clamp it. Remove the handle from the liner now.

## THE ADVANCE KNIFE MAKERS MANUAL

Clamp the liner in a vise, and with the butane torch, heat the bolster until the solder melts. Remove from the vise and quench in water.

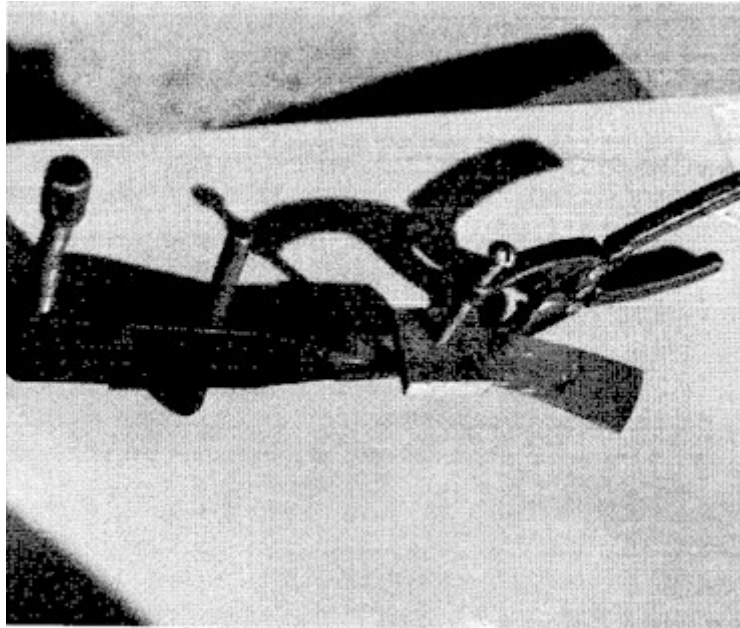

CLAMPING THE BOLSTER TO THE LINER

You can now use the handle as a pattern and cut out the handle for the other side. Make it the same as you did the first one.

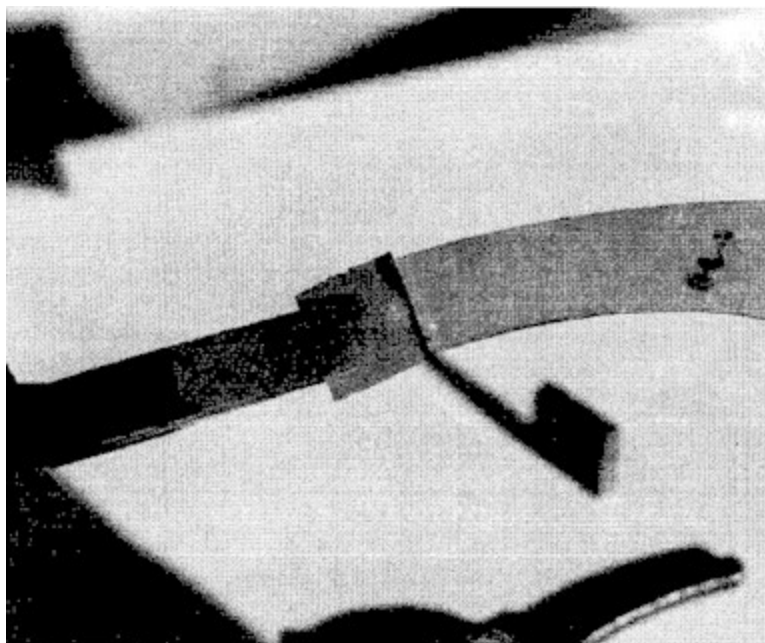

CLAMPED BOLSTER ON LINER

With the bolsters soldered in place, drill two or three 0.053 holes in the liner. Through these holes, you will attach the handle material. Mark a spot about 1 inch from the 45-degree

## THE ADVANCE KNIFE MAKERS MANUAL

angle on the bolster. We should center this on the liner. Center punch, and drill the hole. Now measures about 1 inch from the end of the liner, center, and drill another hole. If you use a rear bolster, measure 1 inch from the 45-degree angle.

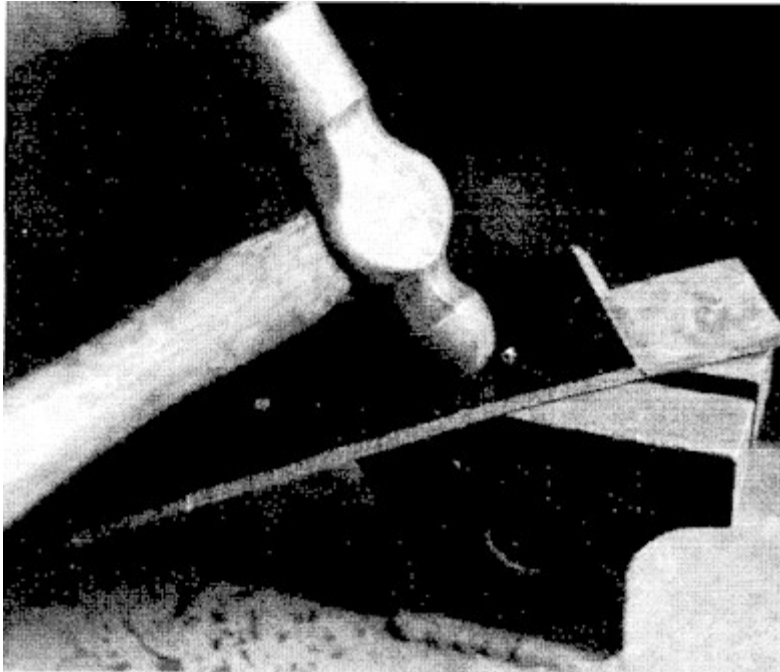

*PINNING THE HANDLE ON LINER*

With the handle clamped in place, turn over the liner, and drill through the holes, and through the handle. These holes will be counter sunk on both sides a little. Counter sinks these just enough so the pins will grip well.

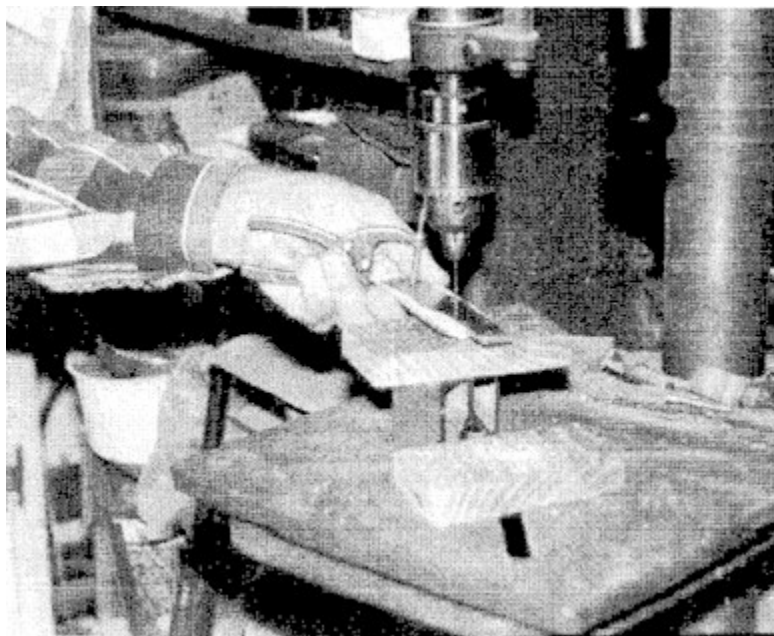

*DRILLING PIN HOLES IN THE HANDLE AND LINER*

## THE ADVANCE KNIFE MAKERS MANUAL

Take a piece of .050 nickel silver wire; insert it through one of the holes. Clip it off flush, turn the liner over, and lay the liner on the vise. With a little ball peen hammer, very carefully roll the edges of the pin just enough so it will fit the counter sink.

Turn over the liner and on the handle side and repeat the process. If you have more than .015 sticking out, take a little more off, so it barely sticks up. The reason for this is that if there is too much pin and peening it down will cause it to swell. It will then split the handle. Repeat the process on the other holes. When the handle is fitted to the liner/bolster, you are ready to grind the blades.

# THE ADVANCE KNIFE MAKERS MANUAL

## FIXED BLADE KNIVES

The process of making a fix blade knife is about the same as making a folding knife. The main difference is that we cut out the blade and handle together, and we then attach the handle material. The main parts of a rigid blade knife are the blade, tang, front guard, butt caps, and handles.

In fixed blade knives, there are two types of tangs used. They call these a flat tang, which uses rivets or screws to hold the handles on, and a round tang with the end threaded for a butt cap, such as the military knives.

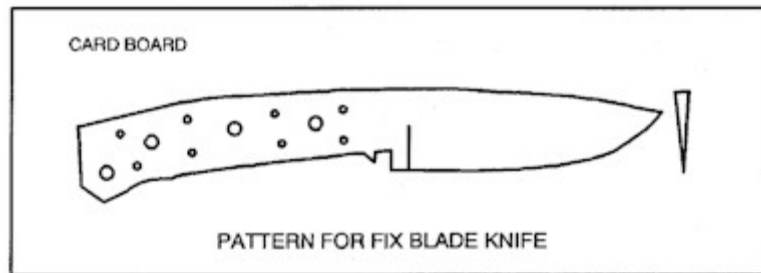

The flat tang will have handles riveted onto the tang. The round tang can use a solid handle such as Stag with a center hole or by using leather washers. This type handle is then placed on the round tang and we screw the butt cap onto the end. Using a hole saw you could make leather washers out washers from a piece of leather.

If you want to use your own design, you will need to draw the knife design to actual size. When you design a folder, you always start with the blade first. Sketch this out on thin cardboard. Estimate the location of the pivot hole (refer to the drawing) and use a compass to draw a small circle around this point. The circle should have about a half-inch a 1/4-inch radius.

In designing a fix blade knife, get some cardboard and draw the complete blade with the tang on it. You then cutout this cardboard pattern of the blade that you want to use, being careful to be accurate in the cutting.

With a scissors, cut out the outline of the blade. Whenever you design a knife always design a blade first, and then make the handle to fit the blade.

Take a piece of tool steel the thickness that you want the blade made from. Usually knives with blades less than two 1/2 inches you use steel under 1/8 inch, and blades more than two 1/2 inches long use 3/16 inch stock.

Wipe any grease or oil off the tool steel. Give it a good coating of layout fluid, or Dykem. We put this on so you can see the scribe mark that you use to mark out the pattern. Lay the

## THE ADVANCE KNIFE MAKERS MANUAL

blade template on the tool steel stock. Hold it down good, or use a clamp so it does not move. Take a very sharp scribe or a heavy needle and mark around the template. Repeat the process with the other parts. You can use brass or tool steel for the handle template.

Once we mark out the parts, they are ready to cut out on the band saw. Make sure that the band saw is running at a slow speed. Do not try to cut the steel at wood cutting speeds. The teeth of the band saw blade would burn off. Carefully follow the lines that we marked on the tool steel.

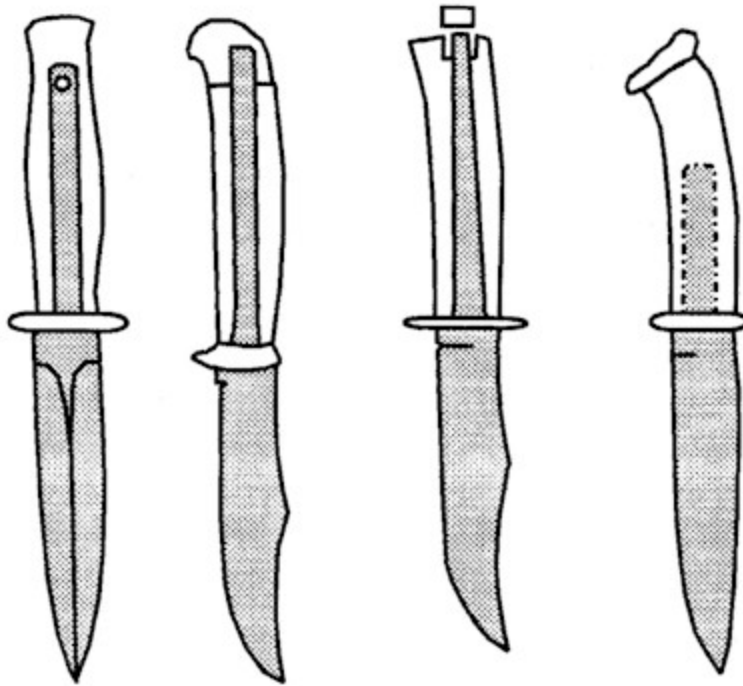

DIFFERENT TYPES OF HANDLE TANGS

Cut out each piece for the knife, leaving a .032 or so on the outside edge of all the pieces that you cut. When the design is ready, transfer the outline of the spring and blade onto the steel. Be sure that you have Dykem or lay out fluid on your steel now so it will mark easily.

Holding the pattern in place and with the scribe, carefully trace around the pattern so you will have a scratched mark for you to follow when you cut out the steel on the band saw. A pencil can also be used to trace around the pattern but you will find that this will be harder to see when cutting.

While the pattern is in place on the steel, center punch where you want the holes and drill the holes. By doing this right away you will have a large piece of steel to hold onto, this makes drilling a little easier and safer. Make sure to cut around the holes so at least 1/26 inch of steel remains all around.

Center punch, and drill the holes for the rivets that hold the handle slabs. I normally use three



## THE ADVANCE KNIFE MAKERS MANUAL

holes, but you can use any number that you want. The rivets placement is not only a practical matter, but one of aesthetics as well. Do not place the rivets too close to the edge.

This risks splitting the handle material or wearing away the rivet head as the handle is rounded into a comfortable shape. The size of the rivet is similarly a matter of looks. I use an 1/8-inch rivet on most of my knives, as this is large enough and gives the knife more strength. The same size rivet on a more delicate knife would be out of proportion.

### CUTTING OUT THE BLADE

The steel cutting band saw blade can only cut annealed steel, so the first rule is that the steel must be annealed. If you buy from a knife supplier, the steel will most likely be in the annealed state when you get it. Some knife makers use a torch, hacksaw, etc. but all these methods are slower and do not produce good results.

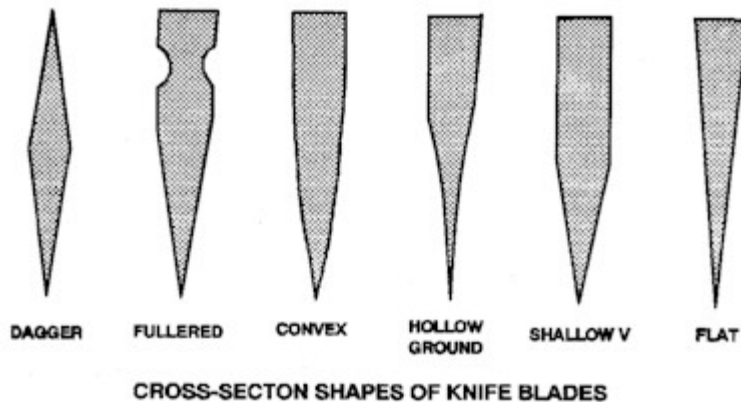

To anneal saw blade steel, or any low alloy carbon steels, heat it in a furnace to about 1200 ° F. This is a dull, faint red, and cool slowly for three hours by turning the furnace off with the steel still inside. The other way is to heat the steel and place it in powdered lime to hold the heat in the steel, allowing it to cool very slowly.

The metal cutting blade must be of fine quality and with teeth small enough so that three of the teeth are on the work piece always. The saw needs to run at the right speed, which means, if it is cutting at wood cutting speed we should install a speed reducer on the band saw.

The cutting speed for steel is very slow, or around 80 FPM for most steel cutting blades. I could not get a speed reducer and had to modify my saw with a double set of large and small pulleys to make it run slowly enough so that it did not burn the teeth off the blade. Once the knife is cut out, carefully grind off the saw mark from the edges, and true up the blank to its final shape on the outside.

If you haven't already done it, now is the time to drill all the holes in the tang. When drilling the tang to receive pins or rivets, you naturally want to use high-speed bits although the metal is

## THE ADVANCE KNIFE MAKERS MANUAL

relatively soft. Also lubricate the drill hole with cutting or light machine oil as you drill.

### TANGS

The full-tang design is also well adapted to the use of a double hilt or guard. If we want a single-hilt design, a fully slotted or split-end hilt design must be used, as the width of the tang is approximately the same as the width of the blade where it meets the tang. There are several variations of this design and coming up with about any style or shape is possible.

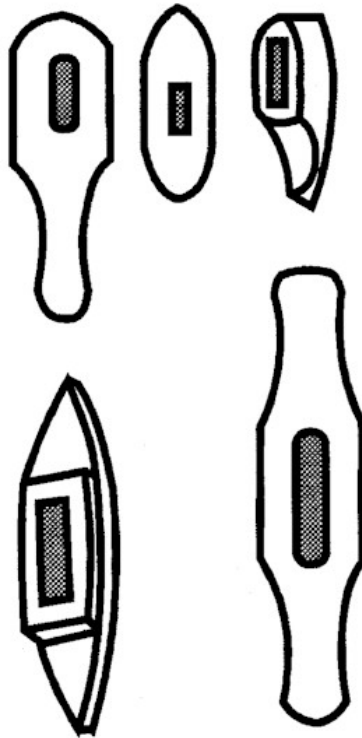

**TYPE OF KNIFE HILTS  
THAT CAN BE CAST**

The round tang is not actually round, but rectangular for most of its length. Only the upper inch or so of the tang is actually round, and we normally thread this portion to accept a tapped nut or pommel. On most tangs, you will find it necessary to file the end of the tang to a perfectly round dimension, and then thread it yourself with a correct size-threading die.

The threads on many factory-threaded tangs are made to receive a standard 10 x 24-machine screw thread. Drills and taps can be used for finishing the pommel material. Local hardware stores will have the taps and dies and they can be purchased individually if you want. The tang on the knife will need to be threaded before heat-treating.

When you use a round tang, you will usually use a stick or block material for the handle. When making a handle for a round tang, one or two parallel holes we drill the entire length of the stick, and we insert the tang through them. This should be done before any shaping work



## THE ADVANCE KNIFE MAKERS MANUAL

is done on the handle. Long, straight sections of stag are suited to this construction method, and round-tang construction is requisite to handles made of leather.

It is also possible to bend round tangs to obtain desired handle angles-something that may be increasingly popular in knife design.

To bend the tang, you need to place the knife in a vise, heat the tang with a torch, and then peen it rapidly but lightly with a medium-weight ball peen hammer. The tang can also be bent by inserting it in a pipe of appropriate size and applying steady pressure while heating the tang.

## GRINDING THE BLADES

The convex bevel is best for cutting materials that is heavy and hard, where a large amount of force is used, such as bone or wood. This is because the cutting edge is backed by thick, heavy steel that is unlikely to break.

The concave bevel is used for softer materials, such as vegetables or meat where the blade cuts deeply, producing little friction. They also know it as a hollow grind because the side of the knife is hollowed out along the edge. It cuts more easily, but is not as strong. As the cutting edge wears back after many subsequent sharpening, the convex blade becomes thicker and thicker. They also call it the axe grind and through use become harder and more difficult to sharpen, while the concave blade stays at the same thickness for many, many sharpening.

The straight bevel or simple wedge is half way between the other two shapes. The intended use of the knife determines the shape and thickness of the cutting edge and the way in which we grind it. I usually start with a hollow grind, and if the knife will have a convex bevel, or a straight bevel, then I do not take the hollow grind shallower. I hollow grind most knives and do about 85 percent of the stock removal with the heavy thirty-six grits on the knife grinder.

When you start grinding the blade, taking long even passes along the full length of the blade. Do not stop in anyone place or it will become deeper in that spot. If this happens, feel the evenness of your work so you can lighten up the pressure when you come to a depression or hold longer when you come to a high spot. You will have more leverage along the edge nearest the handle; we can take this area down too thin before you realize it. As you are about halfway through grinding, concentrate on keeping the edge even.

Grind out a groove along the blade matching to the arc of your wheel. Tilt the blade backward slightly on each pass, and gradually remove more stock toward the edge, producing a straight line from the deepest point of the hollow grind to the cutting edge.

Keep repeating this process until you are about half way done on one side, and then turn the blade around and continue on the other side.

Do not take too much material off in anyone place. When you have both sides approximately half ground, be careful about keeping things even and about the same distance up on each side of the blade. Dip the blade in water every so often, running your fingers up and down the edge feeling for thick and thin spots. Keep grinding until the blade it is about 85 percent complete.

If you are grinding a thin blade, such as a trapper knife, you probably cannot grind as much before heat-treating.

If we grind the blade too thin before heat-treating, it will probably warp. Now, heat treat the

## THE ADVANCE KNIFE MAKERS MANUAL

blade, and regrind it carefully to its desired thickness. The regrinding is done on a belt grinder, using a new, coarse belt.

If you want a good smooth job, grind the blade at least three or four more times with the belt grinder, each time with a progressively finer grit belt.

Grinding the tip of the blade, where the edge tapers off, is next, and it is difficult, requiring much practice. This is especially true getting the hollow grind to go clear to the tip. When finish grinding you will have a thin tip, but not so thin as to be weak. The line of the hollow grind should be mostly parallel with the edge, but perhaps tapering slightly toward the edge near the tip.

On grinding this bevel, I run a series of shallow cuts from the edge up to the backbone of the blade with the knife grinder. Usually, when I finish the blade I usually use a flat belt sander (8 X 48) for this type of grinding.

I believe this is the easiest type of blade to make. It is used for heavier knives such as combat knives, or hatchets. There is little danger of accidentally grinding the edge too thin and ruining the knife. You make the deepest cuts along the edge, where they are easily seen and felt. Grind the heaviest along the edge, and then tapering it according to the design of the knife.

If the blade is too thin when it is heat treated, it may crack or curl up like a potato chip during the process. If it is too thick when hardened, you will spend more time grinding the steel to its desired thinness. Hardened steel more difficult to grind, but it must be kept cool during the regrinding process.

We would damage a very thin knife, like a trapper blade, if we ground it more than 75 percent toward completion.

Normally, grind a blade as near to 90 percent of completion as you can, and use the 10 percent of the stock for removal in the final grinding and polishing steps. If the knife has a very thin ground edge, in relation to the thickness of the back of the blade, remove a smaller amount of stock before heat-treating.

Generally, I grind the blade to about .024 to .028 in thickness at 1/2 inch from the cutting edge after they have been heat treated and reground. I like blades with a fine grind, for outdoor use, with exception of heavy hunting and survival type knives.

If you have a Wilton grinder, get it set up with the eight-inch drum for grinding. The Wilton also has an attachment that has a flat surface for the blades to set against. This needs to be set up on the grinder. What this does is to give you added support when rough grinding.

Get a pair of Vise Grips and clamp it on tight to the rear of blade blank. This wants to be in

## THE ADVANCE KNIFE MAKERS MANUAL

front of the hinge pinhole.

Use a 36-grit belt for rough grinding the blank. You will need to scribe a line on the blank, following the curve of the blade. By doing this, you can grind both sides the same. After we rough grind the blades, and heat-treated you will need to scribe another line for the finish grinding.

Turn on the grinder and center the belt. Whatever you do, **WEAR SOME TYPE OF PROTECTIVE EYE SHIELD**. The belt is moving at a very high rate of speed, and if it breaks, it could cause serious harm.

With the blade being held in the vise grips, and the back of the blade against the support, make a light pass on the blade. The cutting edge of the blade will be up. Start from the back of the blade next to the kick, and bring the blade along evenly against the wheel. For now, do not try to bring the tip of the blade to a cutting edge. All of this will be done later.

You should experiment on the angle of the blade. You want both sides when completed to come to the center of the blank on the cutting edge. Make several passes along the side of the blade, while you get the feel of the grinding. After each pass look at the contour, and try to keep it even. With a little practice, you will be able to rough grind a blade in 3-4 minutes. Remember to do one side and then the other. This will help to keep every thing even.

Let me explain a little further. When I say to the center of the cutting edge, I mean leave about 0.040 on the cutting edge, and we should center this. This is how much stock to be left for heat-treating. This assures you a little extra stock in case the blade warps. More on this later.

Do not worry how hot the blank gets during grinding, as long as it does not get cherry red. Carefully grind both sides down so they will be even. Try to keep the hollow grind fitting the wheel. This is a little hard to do holding the blade in vise grips. Just remember that rough grinding is what it means, taking off excessive metal. If you grind the blade too thin there is a very good chance it will warp. The cutting edge will probably look like a washboard.

If the hollow grind is a little uneven, it can be straightened up when you finish grind the blade. On the scribe marks, leave them about 1/8" of the way from the top of the blade.

When you have the blade rough ground, and completed, it is time to stamp the nail notch in the blade. Yes, I said stamp the nail notch in.

# THE ADVANCE KNIFE MAKERS MANUAL

## NOTCH STAMPING TOOL

This is very easy to do. Get a tool bit 1/2 inch square; the kind used in machine shops for turning steel. Take a factory knife that has a nail notch in it for a pattern. Grind the end of the cutter bit down to match the shape of the notch in the factory blade. Do not worry if the factory notch is a little wider. You can walk this stamp to make the notch longer if you want.

When you get it almost finish, turn it end for end. If there is a sharp or square edge on the end that will be struck with the hammer, round it off, as tool steel is very hard, and may shatter and throw out steel splinters.

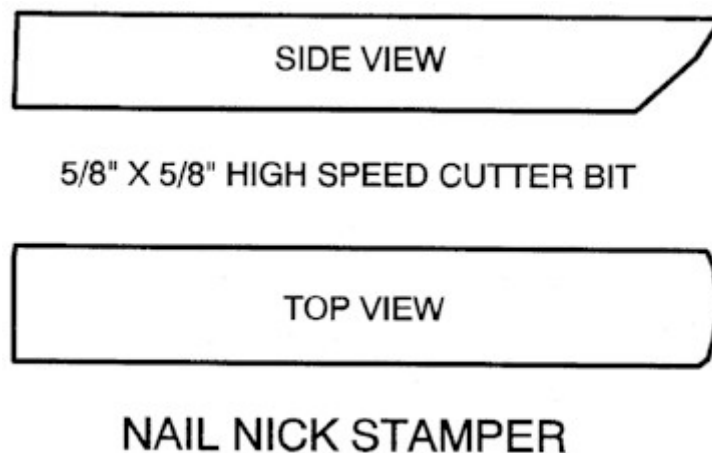

Use a piece of 1/4 inch flat cold roll steel or equivalent to check to see if you have it ground right. Set the plate on an anvil, or other hard surface, hold the stamp in place. With a large hammer, give the stamp a good smack. You should repeat this two or three times to get the proper depth.

**NOTE** - some steel such as stainless steel may split if we make the notch too close to the top. I would suggest heating the back of the blade to a dull red before stamping. Go easy with stainless.

I would suggest leaving at least 1/16-inch clearance from the back of the blade to the notch. If you get a little more, you can always grind it off later.

After stamping the nail notch, be sure to check to be sure the blade is still straight. More than likely the blade will be slightly bent from the swaging operation. Lay the blade on the anvil, and lap it lightly to straighten it. Check it with a straight edge for straightness.

The next thing that needs to be done is to stamp your name, a logo, and a date, serial Number on the shank of the blade. Stamp it deep, as sometimes during heat treating the blade will warp slightly. This can be straightened out also by tapping it out on the anvil.

## THE ADVANCE KNIFE MAKERS MANUAL

Check over everything to be sure you have not missed anything, and if everything is OK, you can now heat-treat the blade. Make sure that you have the springs, locks, etc. cut out and the proper size holes drilled.

This is the part where you take a soft piece of metal, and turn it into a cutting tool. Heat-treating is not difficult unless you get into Stainless Steel or other high temperature tool steels. I will show you how to heat-treat tool steels such as O1.

# THE ADVANCE KNIFE MAKERS MANUAL

## MARKING OUT THE FIX BLADE KNIFE

Take a piece of tool steel the thickness that you want the blade made from. Usually knives with blades under 2 1/2 inches you use 1/8 inch. Blades over 2 1/2 inches long, use 1/8-inch stock.

Wipe any grease or oil off the tool steel. Give it a good coating of layout fluid, or Dykem. This is put on so you will be able to see the scribe mark that you use to mark out the pattern. Lay the blade template on the tool steel stock. Hold it down good, or use a clamp so it doesn't move. Take a very sharp scribe, or a heavy needle and mark around the template. Repeat the process with the other parts. You can use brass or tool steel for the handle template.

Once the parts are marked out, they are ready to cut out on the band saw. Make sure that the band saw is running at a slow speed. Do not try to cut the steel at wood cutting speeds. The teeth of the band saw blade would burn off. Carefully follow the lines that were marked on the tool steel.

Cut out each piece for the knife, leaving a .032 or so on the outside edge of all the pieces that you cut. When the design is ready, transfer the outline of the spring and blade onto the steel. Be sure that you have Dykem or lay out fluid on your steel now so it will mark easily.

Holding the pattern in place and with the scribe, carefully trace around the pattern so you will have a scratched mark for you to follow when you cut out the steel on the band saw. A pencil can also be used to trace around the pattern but you will find that this will be harder to see when cutting.

While the pattern is in place on the steel, center punch and drill the holes. By doing this right away you will have a large piece of steel to hold onto, which makes drilling a little easier and safer. Make sure to cut around the holes so at least 1/26 inch of steel remains all around.

Center punch and drill holes for the rivets that hold the handle slabs. I normally use three holes, but you can use any number that you want. The rivets placement is not only a practical matter, but one of aesthetics as well. Do not place the rivets too close to the edge. This risks splitting the handle material or wearing away the rivet head as the handle is rounded into a comfortable shape. The size of the rivet is similarly a matter of looks. I'm use a 1/8-inch rivet on most of my knives, as this is large enough and gives the knife strength. The same size rivet on a more delicate knife would be out of proportion.

## CUTTING THE STEEL WITH A BAND SAW

This is a better way to cut your knife out, because it is much more precise, and there is very little heat generated which could set up unnecessary stresses in the steel.

Some knife makers use a torch, hacksaw, etc. but all of these methods are slower and do not

# THE ADVANCE KNIFE MAKERS MANUAL

produce good results.

The steel cutting band saw blade can only cut annealed steel, so the first rule is that the steel that you cut must be properly annealed. If you buy from knife supplier, the steel will most likely be in the annealed state when you get it.

To anneal saw blade steel, or any low alloy carbon steels, heat it in a furnace to about 1200° F. that is a dull, faint red, and cool slowly for three hours by turning the furnace off with the steel still inside. The other way is to heat the steel and place it in powdered lime to hold the heat in the steel, allowing it to cool very slowly.

The metal cutting blade must be of fine quality, and with teeth small enough so that three of the teeth are on the work piece always. The saw needs to run at the right speed, which means if it is cutting at wood cutting speed a speed reducer will have to be installed.

The cutting speed for steel is very, very slow, or around 80 FPM for most steel cutting blades. I wasn't able to get a speed reducer and had to modify my saw with a double set of large and small pulleys to make it run slowly enough so that it didn't burn the teeth off the blade. Once the knife is cut out, carefully grind or file the saw mark from the edges, and generally true the blank to it final shape on the outside.

If you haven't already done it, now is the time to drill all the holes in the tang. When drilling the tang to receive pins or rivets, you naturally want to use high-speed bits even though the metal is relatively soft. Also lubricate the drill hole with cutting or light machine oil as you drill.

## TANGS

The full-tang design is also well adapted to the use of a double hilt or guard. If a single-hilt design is desired, a fully slotted or split-end hilt design must be used, as the width of the tang is approximately the same as the width of the blade where it meets the tang. There are several variations of this design and it is possible to come up with about any shape possible.

The round tang is not actually round, but rectangular in shape for most of its length. Only the upper inch or so of the tang is actually round, and this portion is normally threaded to accept a tapped nut or pommel. On most tangs you will find it necessary to file the end of the tang to perfectly round dimensions, then thread it yourself with a die of correct size die.

The threads on many of the factory-threaded tangs are made to receive standard 10 x 24 machine screw thread. Drills and taps can be used for finishing the pommel material. Local hardware stores will have the taps and dies and can be purchased individually. The tang on the knife will need to be threaded before heat-treating.

When you use a round tang you will usually use of a stick or block for the handle. When making a handle for a round tang, one or two parallel holes are drilled the entire length of the stick, and the tang is inserted through them. This should be done before any shaping work is



## THE ADVANCE KNIFE MAKERS MANUAL

done on the handle. Long, straight sections of stag are suited to this construction method, and round-tang construction is requisite to handles made of leather.

It's also possible to bend round tangs to obtain desired handle angles-something that seems to be increasingly popular in knife design.

To bend the tang, you need to place the knife in a vise, and heat the tang with a torch, and peen it rapidly but lightly with a medium-weight ball peen hammer. The tang can also be bent by inserting it in a pipe of appropriate size and applying steady pressure while heating the tang.

# THE ADVANCE KNIFE MAKERS MANUAL

## GRINDING THE BLADE

### TYPES OF GROUND EDGES

The convex bevel, is best for cutting things that are heavy and hard, where a large amount of force is used, such as bone or wood, because the cutting edge is backed by thick, heavy steel that is unlikely to break.

The concave bevel, is suited to softer materials, such as vegetables or meat where the blade cuts deeply, producing little friction, It's also known as a hollow grind because the side of the knife is hollowed out along the edge. It cuts more easily, but is not as strong. As the cutting edge wears back after many subsequent sharpening, the convex blade becomes thicker and thicker. It is also called the axe grind and through use becomes harder and more difficult to sharpen, while the concave blade stays at the same thickness for many, many sharpening.

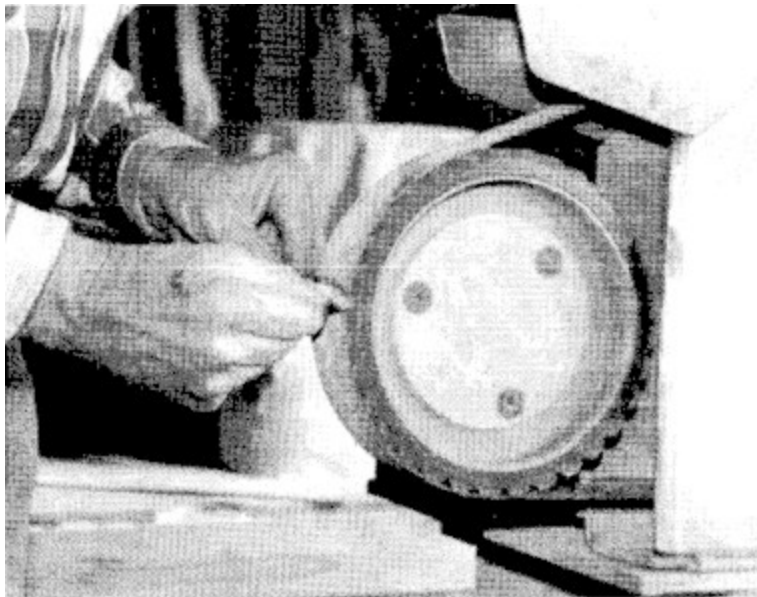

GRINDING THE BLADE

The straight bevel or simple wedge, is half way between the other two shapes. The intended use of the knife determines the shape and thickness of the cutting edge as well as the way in which it is ground. I usually start out with a hollow grind, and if the knife will have a convex bevel, or a straight bevel, then I do not take the hollow grind more shallow. I hollow grind most knives and do about 85 percent of the stock removal with the heavy 36 grit on the knife grinder.

### GRINDING

When you start grinding the blade, taking long, even passes along the full length of the blade. Do not stop in any one place or it will become deeper in that spot. If this happens, feel the evenness of your work so you can lighten up the pressure when you come to a depression or

# THE ADVANCE KNIFE MAKERS MANUAL

hold longer when you come to a high spot.

You will have more leverage along the edge nearest the handle, this area can be taken down too thin before you realize it. As you are about halfway through grinding, concentrate on keeping the edge even.

## THE HOLLOW GRIND

Grind out a groove along the blade matching to the arc of your wheel. Tip the blade backward slightly on each pass, and gradually remove more and more stock toward the edge, producing a straight line from the deepest point of the hollow grind to the cutting edge.

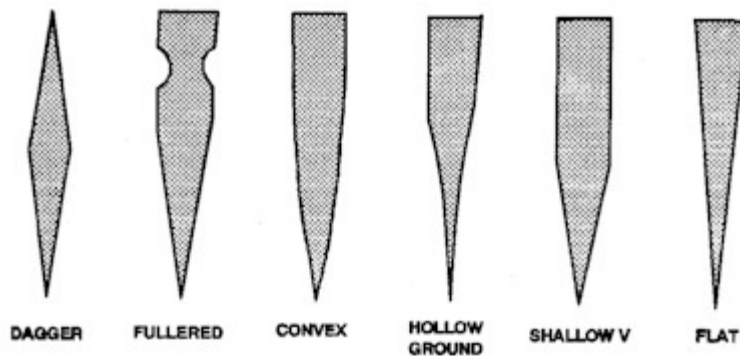

CROSS-SECTION SHAPES OF KNIFE BLADES

Keep repeating this process until about half done on one side is finished, and then, turn the blade around and proceed on the other side.

Do not take too much material off in any one place. When you have both sides approximately half ground, be careful about keeping things even and about the same distance up on each side of the blade. Dip the blade in water every so often, running your fingers up and down the edge feeling for thick and thin spots. Keep grinding until the blade is about 85 percent complete.

If you are grinding a thin blade, such as a trapper knife, you may not be able to grind as much before heat treating. If the blade is ground too thin before heat

treating it will probably warp. You only grind the blade so thin then heat treating the blade, then regrind it carefully, so as not to heat the blade, regrind it to its desired thickness. The regrinding is done on a belt grinder, using a new, coarse belt.

If you want a good smooth job, grind the blade at least three or four more times with the belt grinder, each time with a progressively finer grit belt.

Grinding the tip of the blade, where the edge tapers off, is next and it is difficult requiring much practice. This is especially true getting the hollow grind to go clear to the tip. When

## THE ADVANCE KNIFE MAKERS MANUAL

finish grinding you will have a thin tip, but not so thin as to be weak. The line of the hollow grind should be mostly parallel with the edge, but perhaps tapering slightly toward the edge near the tip.

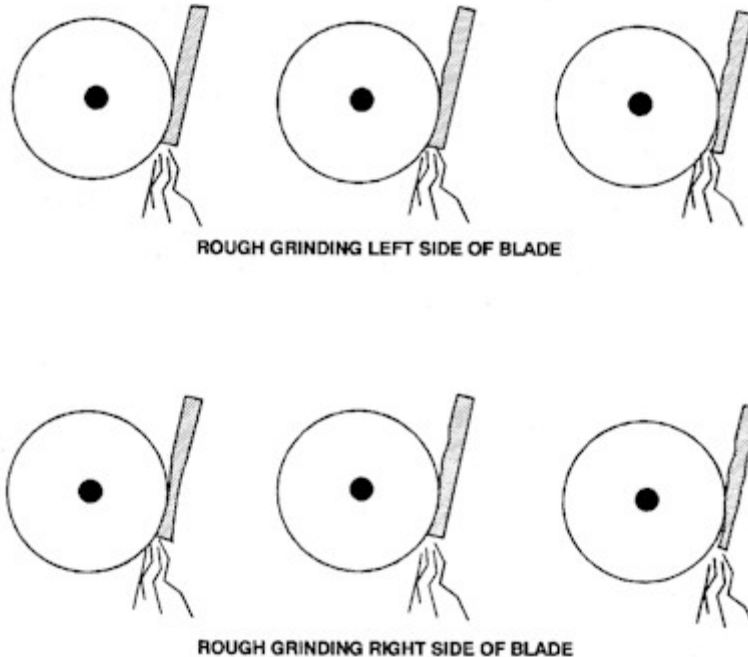

### THE STRAIGHT BEVEL

On grinding this bevel, I run a series of shallow cuts from the edge up to the backbone of the blade with the knife grinder. In most cases when I finish the blade I usually use a flat belt sander (8" X 48") for this type of grinding.

### THE CONVEX BEVEL OR ROLLED EDGE

I believe this is the easiest type of blade to make. It is used for heavier knives such as combat knives, or hatchets. There is little danger of accidentally grinding the edge too thin or messing up the knife.

You make the deepest cuts along the edge, where they are easily seen and felt. Grind heaviest along the edge, and then tapering it according to the design of the knife.

### HOW MUCH TO GRIND BEFORE HEAT TREATING.

If the blade is too thin when it is heat treated, it may crack or curl up like a potato chip during the process, or if it is too thick when hardened, you will have to spend more time grinding the steel to its desired thinness. Hardened steel more difficult to grind, but it must be kept cool during the regrinding process.

## THE ADVANCE KNIFE MAKERS MANUAL

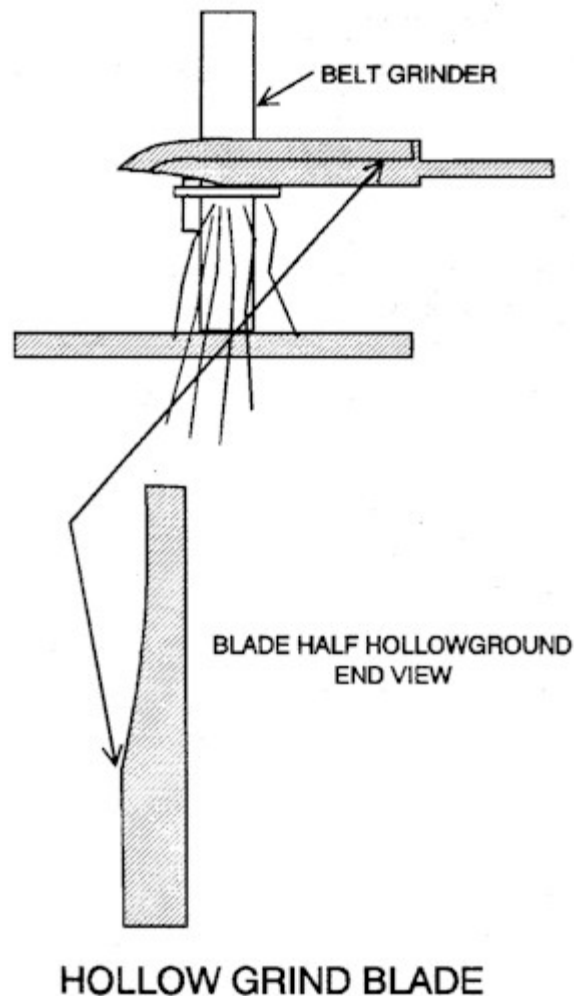

A very thin knife, like a trapper blade, would be damaged if it was ground more than 75 percent toward completion.

Normally, grind a blade as near to 90 percent of completion as you can, and use the 10 percent of the stock for removal in the final grinding and polishing steps. If the knife has a very thin ground edge, in relation to the thickness of the back of the blade, remove a smaller amount of stock before heat treating.

Generally I grind the blade to about .024" to .028" in thickness at about 1/4 inch from the cutting edge after they have been heat treated and reground. I like blades with a fine grind, for outdoor use, with exception of heavy hunting and survival type knives.

### GRINDING THE BLADE

If you have a Wilton grinder, get it set up with the 8" drum for grinding. The Wilton also has an

## THE ADVANCE KNIFE MAKERS MANUAL

attachment that set a flat surface for the blades to set against. This needs to be set up on the grinder. What this does is to give you added support when rough grinding.

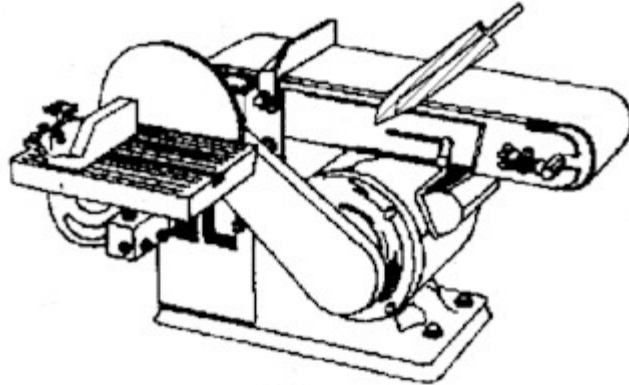

**FLAT GRINDING KNIFE ON BELT SANDER**

Get a pair of Vise Grips and clamp it on tight to the rear of blade blank. This wants to be in front of the hinge pin hole.

Use a 36 grit belt for rough grinding the blank. You will need to scribe a line on the blank, following the curve of the blade. By doing this, you will be able to grind both sides the same. After the blades are rough ground, and heat treated you will need to scribe another line for the finish grinding.

Turn on the grinder and center the belt. What ever you do, WEAR SOME

### **TYPE OF PROTECTIVE EYE SHIELD.**

The belt is moving at a very high rate of speed, and if it breaks it could cause serious harm.

With the blade being held in the vise grips, and the back of the blade against the support, make a light pass on the blade. The cutting edge of the blade will be up. Start from the back of the blade next to the kick, and bring the blade along evenly against the wheel. For now do not try to bring the tip of the blade to a cutting edge. All of this will be done later.

You will have to experiment on the angle of the blade. You want both sides when completed to come to the center of the blank on the cutting edge. Make several passes along the side of the blade, while you get the feel of the grinding. After each pass look

at the contour, and try to keep it even. With a little practice you will be able to rough grind a blade in 3-4 minutes. Remember to do one side and then the other. This will help to keep every thing even.

## THE ADVANCE KNIFE MAKERS MANUAL

Let me explain a little further. When I say to the center of the cutting edge, I mean leave about 0.040 on the cutting edge. This should be centered. This is how much stock to be left for heat treating. This assures you a little extra stock in case the blade warps. More on this later.

Do not worry how hot the blank gets during grinding, as long as it doesn't get cherry red. Carefully grind both sides down so they will be even. Try to keep the hollow grind fitting the wheel. This is a little hard to do holding the blade in vise grips. Just remember that rough grinding is what it means, taking off excessive metal. If you grind the blade too thin there is a very good chance it will warp. The cutting edge will probably look like a wash board.

If the hollow grind is a little uneven, it can be straighten up when you finish grind the blade. On the scribe marks, leave them about 1/3 of the way from the top of the blade.

### NAIL NOTCH

When you have the blade rough ground, and completed it is time to stamp the nail notch in the blade. Yes, I said stamp the nail notch in.

This is very easy to do. Get a tool bit 5/8 inch square, the kind used in machine shops for turning steel. Take a factory knife that has a nail notch in it for a pattern. Grind the end of the cutter bit down to match the shape of the notch in the factory blade. Do not worry if the factory notch is a little wider. You can walk this stamp to make the notch longer if you so desire.

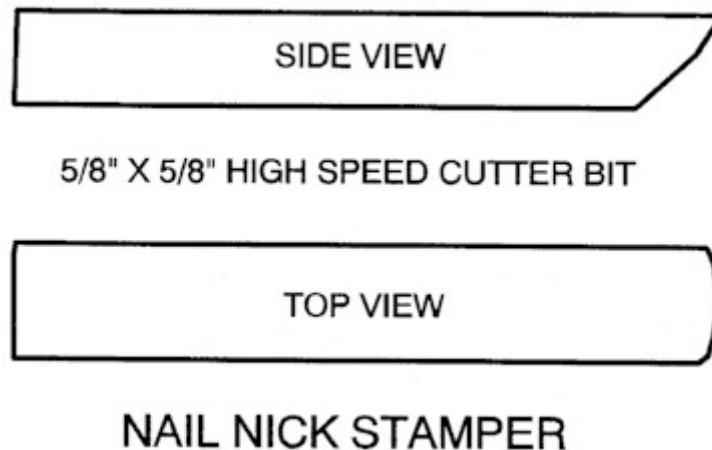

When You get it fairly well finish, turn it end for end. If there is a sharp or square edge on the end that will be struck with the hammer, round it off. Tool steel is very hard, and may shatter and throw out steel splinters.

### STAMPING THE NAIL NOTCH

## THE ADVANCE KNIFE MAKERS MANUAL

Use a piece of 1/8 inch flat cold roll steel or equivalent to check to see if you have it ground right. Set the plate on an anvil, or other hard surface, hold the stamp in place. With a fairly large hammer, give the stamp a good smack. You will have to repeat this 2 or 3 times to get the proper depth. If the stamp is ground as you want, you can stamp the nail notch in the blade.

**NOTE**--Some steels such as stainless steel may split if the notch is made too close to the top. Go easy with stainless.

I would suggest leaving at least 1/16 inch clearance from the back of the blade to the notch. If you get a little more, you can always grind it off later.

After stamping the nail notch, check to be sure the blade is still straight. More than likely the blade will be slightly bent from the swaging operation. Lay the blade on the anvil, and tap it lightly to straighten it. Check it with a straight edge for straightness.

The next thing that needs to be done is to stamp your name, logo, date, serial No. on the shank of the blade. Stamp it deep as sometimes during heat treating the blade will warp slightly. This can be straightened out also by tapping it out on the anvil.

Check over everything to be sure you haven't missed anything. If everything is OK, you can now heat treat the blade. Make sure that you have the springs, locks, etc. cut out and the proper size holes drilled.

### FINISH GRINDING OF THE BLADE

Now that the blade is heat treated, you can do the finish grinding. You will need to flatten the blank on the belt sander.

When I flatten out the blade; I will finish out the sides completely. I start with 36 grit on the flat belt sander, to flatten the blade. Then I use 180 grit to remove the grind marks, and finish with 240 grit.

When I flat grind the blade, I make sure that the topside of the blade where the lock area is .004 - .005 thousandths thicker than the kick area. The reason for this is that you need this clearance so the knife will close easily. If you leave it flat, it will bind in the handle.

For the final finishing, I use a worn out 240-grit belt; I then coat the belt with white buffing compound. I can then finish the blade to a high finish.

Make sure that all the grind marks are out of the blade, or they will show up when the knife is



## THE ADVANCE KNIFE MAKERS MANUAL

finished. This is important so you can mark the scribe lines on the blank for grinding. To do this, clean up the blade so all the scale is removed. This is done with a wire brush; on a grinder, buffer, or drill press but it needs to be cleaned up enough so that Dykem will stick.

Once the Dykem has been applied and it is dry, you can mark the grind marks. We should mark the grind marks very carefully. These lines will show you how far to finish grind the blade. Several suppliers in the back of this book carry special tools to mark the blade. If you have a good eye, you can grind the blade even without using the scribe lines.

### GRINDING THE BLADE

I usually start using 36 grit. This will true up the blade if there is any warping. You can probably grind the blade close to the finish size. We should grind the cutting edge of the blade now to .020 - .025. All the time that I am grinding the blade I hold it with my fingers. I do not hold the blade with any tool, such as vise grips.

Why don't you hold the blade with Vise Grips? When I am holding the blade with my fingers, I can feel the heat build in the blade. When it gets hot, I dip the blade in a water container that I keep next to the grinder.

If I held the blade with Vise Grips, I would probably burn the blade. This would remove the temper, and soften the blade. I cannot stress the importance of not over heating the blade. When you go to all the trouble of making a blade, then you draw the temper when grinding; you wasted all your work.

If you see any color from a heat buildup, you have gotten the blade too hot and you will soon learn how fast the blade heats up, and when to cool it. When grinding the cutting edge and point, be very careful, as it only takes seconds to heat. Stainless is bad about softening.

After rough grinding with 36 grits, put a 180-grit belt on the grinder. Repeat the process, and remove the 36 grit grinding marks from the blade. Be extra careful from now on, so you do not make any unnecessary mistakes.

### FINISHING THE BLADE

Repeat the process with 240, 320, and 400 grit belts, and when you have finished with the 400-grit belt, the blade should have a very good finish. You must be sure that the finish blade has a thickness of less than .020 on the cutting edge.

This thickness is what makes a blade cut well and hold a good edge, but any thicker, sharpening it will be hard, will not hold an edge good, and probably wont cut good.

The exception to this, is when you want a knife that you can split game with, and on this kind of knife, the blade can be left .030 - .035 on the cutting edge. This type of blade will not hold

## THE ADVANCE KNIFE MAKERS MANUAL

an edge too good, but it will be a much stronger knife.

## MAKING A WORK BLADE

When you are making a knife for this purpose, you should also do another step. With the blade polished, take a butane torch and draw the temper on the back of the blade.

This is done by using a small flame on the back of the blade. Start in the lock area, and holding the EDGE of the flame on the spine, or edge. As the edge heats, you will see color starting to appear on the blade. Do not let this color go to the cutting edge.

The color on the back of the blade should be purple and light straw about HALFWAY to the cutting edge. This will take some practice, and it is best done on an old blade first. Keep a pan of water handy as you draw the back. If the color is getting too close to the cutting edge, dip the cutting edge in the water.

Draw the temper all the way down the blade. Dip the cutting edge into the water anytime the color is getting past HALFWAY. When done, you will have a blade that is very tough, but with a hard edge. We can abuse this type of knife (Heaven Forbid) without too much chance of breaking. This method can only be used with carbon steels. On any type of stainless steels this will not work.

With this done, we can now go to the fitting of the blade.

## HILTS AND POMMELS

The hilt, or guard, of a knife, is the crosspiece that protects your hand from slipping from the handle to the blade, and the pommel or butt cap, which is the part that caps the handle. If you look at many different styles of knives, you will see that some do not have or need hilts or pommels, but they are attractive and useful features of most hunting and fighting knives.

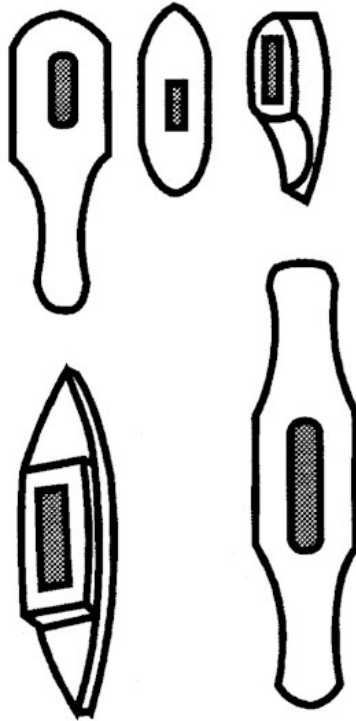

**TYPE OF KNIFE HILTS  
THAT CAN BE CAST**

There are three common types of metals used for hilts and pommels. Brass, aluminum, and nickel silver are normally used for making hilts and pommels. I have used brass for the guard and aluminum for the pommel, simply because it gives much better balance to the knife.

They can also make pommels from stag crowns, particularly when used in combination with wood or leather handles of contrasting color and will make an attractive combination.

**NOTE:** Please remember that the fitting of the hilt is only done after the blade is heat treated and finished. Heat-treating after soldering would melt the solder.

I use three different methods for hilt making. The first is to use bar stock of appropriate width and thickness, the second, you can buy rough castings from a knife supplier that still require considerable grinding, filing, and buffing to complete.

## THE ADVANCE KNIFE MAKERS MANUAL

The third method is what I normally use, and that is to work with materials that I have on hand, usually, I have several different types of material of the right thickness, which I find at a scrap yard.

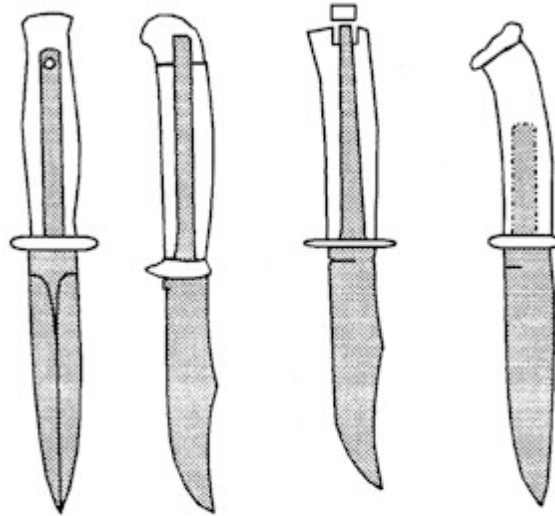

DIFFERENT TYPES OF HANDLE TANGS

Bar or sheet metal will give you the greatest latitude for innovation, because the shape of the hilt is limited only by your own imagination. The knife-maker supply houses carry many shapes and sizes of guards not available in cast form.

There are normally two thickness of stock used for hilts, which is 1/4-inch and d inch, the former is used in its original thickness, and we grind or filed the latter to produce a tapered hilt. I keep stock as thin as 1/8-inch and as thick as 5/8-inch if for hilts, and castings of several sizes and thickness.

Fitting the size and shape of the hilt to the size and design of the knife is important so it is pleasing to the eye and right for the knife use.

When you start to make a hilt from bar stock, scribe a line down the middle of the metal you intend to use. This scribed line should be as long as your tang is wide, and then use a center punch to indent both ends of the line, and at intermediate points along the line. The purpose of the indentations is to mark the hilt about as far apart as the tang is wide.

Use a drill bit that is slightly smaller than the thickness of the tang, and then drill out the hilt along the line you have marked and punched. Use a machinists vise clamped to the bed of the drill press so there will be no movement, and begin with the end holes. When you are through drilling, you have drilled out a slot that is almost as long as the tang is wide, and parallel to the sides of the stock. Rough metal usually remains between the drilled holes and this can be remove with a tungsten carbide cutter mounted in your Dremel Tool or drill press.

## THE ADVANCE KNIFE MAKERS MANUAL

When you get the hilt cleaned up, use a flat needle file to enlarge the slot to the exact dimensions of the tang. Be very careful and be accurate as the quality of the soldering job that follows depends on how good a job you do now. As you continue, test the fit several times, and take the time to fit it as close as possible.

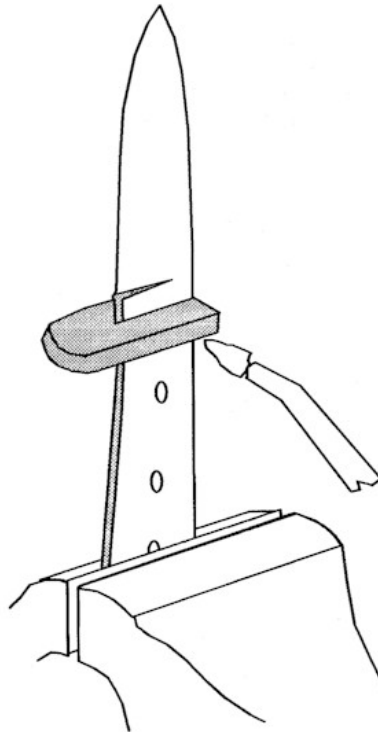

SOLDERING ON HILT

### FULL TANG

The method of construction for a full tang requires the use of an open or split-end hilt that will slide horizontally onto the tang, rather than down its length. If you are making a split-end hilt, you can cut the slot with a band saw rather than drilling it out. Now, scribe parallel lines width of the tang (thick), and drill a hole at the closed end of the slot.

After we have cut, filed the slot and finished to the proper size, grind and file the hilt to the rough, exterior dimensions. Do not take off too much metal but leave as much metal as possible to work with, in case you got the slot slightly off center.

### QUILLONS

If you are making a upswept or down swept quillons on the hilt, soft metals in thickness up to 1/4 inch, can be bent by heating with a propane torch and then peening while the stock is held in a vise. Most cast hilts that you buy from the knife suppliers can be bent, if you take it slow and peen very carefully.

# THE ADVANCE KNIFE MAKERS MANUAL

## SOLDERING

This operation is only done after the blade is heat-treated and flat ground to the final size. When you have finish and we cut and filed the slot to shape, you can solder the hilt to tang. I use only silver solder, as this alloyed of about 96 percent tin and 4 percent silver. If you use lead solder that is tin and lead, it will not give you a strong enough bond, and it will tarnish.

The best type of solder is the type used by gunsmiths for installing gun sights. Brownells has several, types and temperature ranges from which to choose. I like the solder that combines flux with solder in a stable paste form, and it is extremely easy to use.

Silver solder usually has a slightly higher melting point than common lead solder, and you should use a propane torch for the soldering. Be care with the choice of solders, as some silver solder have melting points that exceed or approach the temperature at which carbon steel loses its temper, so do not use solders that exceed 800° F. The low temperature solders melts at around 450-500 degrees F.

## CLEANING THE WORK

To get a good soldering job, you have to get your work extra clean with no traces of scale or oxidation. Sand lightly and then use acetone to remove all traces of oil and grease. At this point, you need to take care in the cleaning, as a poorly cleaned joint will show unsightly gaps when finished.

## SOLDERING ON HILT

When ready to solder, clamp the hilt in place with C clamps and heat the hilt all the way around by directing the tip of your flame at the underside of the hilt. By doing this, it will cause the solder to be drawn into the joint by capillary action. When the solder begins to flow freely, remove the flame. Then use your torch sparingly, because overheating weakens the bond.

Nickel silver conducts heat more slowly than brass so we require a slightly longer heating time. When you use aluminum, you should use epoxy or pin the hilt.

## POMMELS

When you make your pommel, it does not make any difference if the material is bar stock, casting, or antler crown, the method for making a tapped pommel to fit on a round tang is the same.

## THE ADVANCE KNIFE MAKERS MANUAL

After soldering, let the work cool to room temperature and check the joint to see if it is a good job. If everything is OK, clean off the excess solder with a needle file and 400 grit emery cloth.



# THE ADVANCE KNIFE MAKERS MANUAL

## MAKING THE POMMEL

On a round tang, you will use a drilled and tapped pommel. On a modified tang, you will use a slotted and pinned pommel, and a full-tang is normally completed without a pommel.

If you are making a round pommel, you will drill your hole in the approximate center of the stock with which you are working. This is done before you begin shaping the pommel.

If you are using bar stock, 1/8 inch is the thinnest you can use and get enough threads for holding. It would be best to use 1/4 inch or 3/8 inch stock, however, if you want the overhanging lip design, start with 5/8- inch minimum material.

If you have a thread chart use this to select a drill bit that is the correct diameter for the threaded tang. If you buy a pre threaded tang, we usually tap them with a standard 10 x 24 machine screw thread, and checking the thread chart, you will see that you will use a 9/64-inch bit.

I always drill the hole with a drill press to be sure the hole is drilled straight, for if you have not drilled it straight, you will know it when you assemble the knife. Now take your handle, screw the pommel into place, and always use spacers between handle and pommel.

With the handle and pommel firmly in place, grind the pommel into the shape that you want and finish it as you do the handle. After grinding, check over your work and if OK, use epoxy when you screw on your pommel the final time.

Making the handle for your knife is where the persons own identity really comes into its own. You have the choice of working with wood, leather, synthetics, buffalo horn, stag, or other materials, you can make your handle just as plain or fancy as you want.

# THE ADVANCE KNIFE MAKERS MANUAL

## INSTALLING THE HANDLES

I will show you how to install handles for the full tang knife. Cut out the material that you are going to use on your knife, and flatten it out on one side in the flat belt sander.

### CUTTING OUT THE SLABS

The first step is to trace the handle on the material you are going to use. Be sure that the material when added to the thickness of the tang is just a little wider than the desired handle. Cut out the shape on the band saw, the two pieces about the same shape.

Cut out the handle very carefully; make it slightly longer than the outside line of the tang. The more accurate you cut the handle, the less work you will have beveling the slabs flush with the tang. If you are using wood, watch for cracks and checks in the wood.

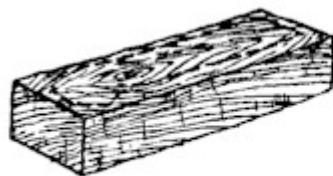

BLOCK MARKED FOR CUTTING



HANDLE CUT TO ROUGH SHAPE

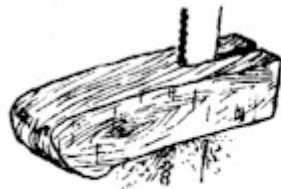

CUTTING HANDLE IN HALVES

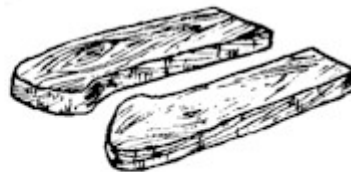

HANDLES READY FOR MOUNTING

### FITTING THE SCALES TO THE TANG

Use a new 80 grit belt on the flat sander and make the inside surface of the scales perfectly flat by sanding, to produce a perfectly smooth, flat surface to fit to the tang.

When you press the slab against the sander, hold it with both hands, one at each end of the slab. This will insure an even, steady pressure against the belt. Check the flatness by putting both slabs together and holding them up to the light.

### FULL TANG KNIFE

Place the scales onto the tang and hold the handle up to the light to see if there are any spaces. Be sure there is no gap between the tang and handle material, as it will distract from the appearance of the finished knife.

# THE ADVANCE KNIFE MAKERS MANUAL

The epoxy that you use will completely fill any gap, but it will still be noticeable.

Unless you are fitting the scales against a hilt, bevel the end of the slabs nearest the blade. We should completely sand and finish this area now, as it will be very difficult to work with later.

## FITTING THE SCALES TO THE BOLSTER

Clean up the inside of the bolster area with a file so it will be clean and fit the slabs perfectly. When you fit the scales to a knife that has a bolster or hilt, it will be a little tricky.

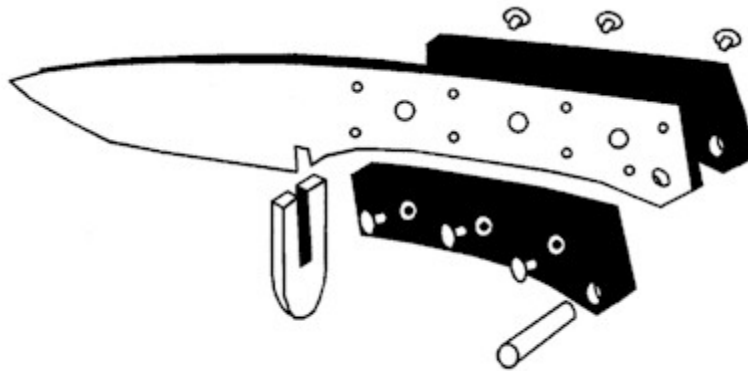

FULL TANG KNIFE

Carefully grind down the end of each scale with an 80-grit belt until it accurately fits against the hilt. Finish with a file to get them exact. Check the fit by holding it up to the light and see if there are any gaps between the scale, bolster or hilt.

## DRILLING THE HOLES IN THE SLABS

After you have the scales fitted perfectly to the tang, you can now drill the holes for the metal rivets or pins. Clamp one slab onto the tang with a small C clamp, and with the slab side down, drill the holes in the slab using the predrilled rivet holes in the tang as a template. Remove the first slab, clamp the second one against the other side of the tang and repeat the above.

If you are going to use rivets instead of pins, drill out the countersink holes for the rivet heads.

## CLAMPING THE SCALES

You will need three or four C clamps before you start, so have them ready. I have found that it makes it easier to install the handles to a knife that has a hilt if you modify a large clamp so that it can hold the scales up against the bolster.

# THE ADVANCE KNIFE MAKERS MANUAL

I use a hacksaw to cut a slot in the end of the C clamp. The other two or three other clamps will clamp the scales to the tang.

Make a trial run and clamp everything together to check the fit before mixing the epoxy! The modified clamp going lengthwise is only used when you have a bolster or finger guard on the knife.

## PINS AND RIVETS

We hold the scales onto the tang with epoxy glue and brass rivets or pins. The rivets have a head on each end that mechanically hold the scales tightly against the shank. The pins simply form a metal connection between the two slabs, being held in place by the epoxy glue.

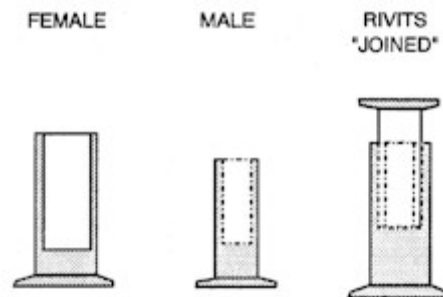

DIFFERENT TYPES OF RIVETS

## DIFFERENT TYPES OF RIVETS

In using rivets, you have to countersink the rivet head flush with the outside of the slab. You need a drill bit that is precisely the size and shape of the rivet head and shaft for this.

The bit consists of a long pilot shaft that fits snugly into the rivet hole, and the two blades that cut away the material, forming the countersink hole. Countersinking bits are available in many sizes from a knife supplier, but you can construct a countersink bit from an existing flat wood drill bit. Reshaping is a simple machining task on the belt grinder.

Pins are the simplest means of holding the scales on. We make them from short lengths of brazing rod.

## COUNTERSINK BIT

The angles of the blades that cut the countersink hole must be the same as the angle of the underside of the rivet head so there is no air space between the rivet head and the scale.

# THE ADVANCE KNIFE MAKERS MANUAL

The countersink is used with the drill press, and the outside of the rivet head should be set just below the surface of the scale.

## REMOVING A RIVET

We include this as invariably you will mess up on setting a rivet, or you need to replace a rivet with a new one. What I do to remove the rivet is to drill out the rivet head with a 13/64-inch drill bit and then knock the shaft of the rivet through with a punch. If the rivet gets hot while we are drilling it, it will break the epoxy bond, and the rivet will spin. Prevent this by placing a file underneath the rivet. The rivet head will catch in the teeth of the file.

After we remove the rivet, you may have to clean out the countersink hole a little in preparation for the new rivet.

## KNIFE MAKER RIVETS

There are rivets made for knife handles, and most are the screw on type, with long heads. After countersinking the heads, we bevel the portion remaining with the belt sander. These rivets are usually available at knife maker's suppliers.

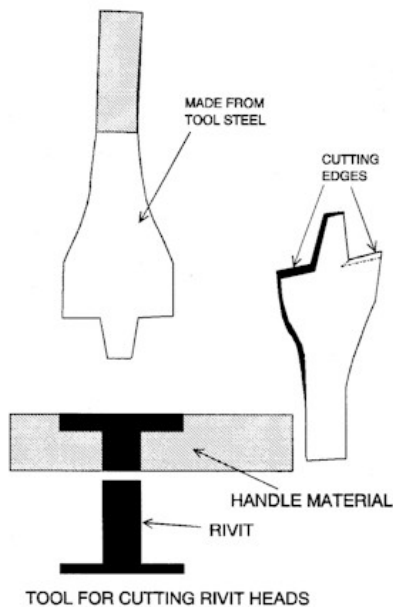

Cutler's rivets consist of two pieces, and one half looks like a nail with a large head and a blunt point. The other half has an identical head, but its shank is a thick-walled tube. The parts are assembled by clamping them, forcing the solid part into the tube where they achieve a very solid grip. Cutler's rivets are available in brass and nickel silver from knife making supplies.

In figuring the hole size for these rivets, choose a drill bit that is slightly larger than the tube

## THE ADVANCE KNIFE MAKERS MANUAL

shank. This will allow for the slight swelling that occurs when the two halves are pressed together.

When the holes are prepared, the rivets can be set into place. Unless your handle is exceptionally thick or thin, the rivets are probably ready to use. When we squeeze the rivet halves together, their total length will be the length of the tube half plus the thickness of the two heads. Hold the rivet next to the handle to check to be sure that it is the proper length and it will work. Before setting, the rivet should stick up no more than 3/16 inch or it will be too long when set. The idea is to have the rivets fit as snugly as possible, but not too tight.

### EPOXY GLUE

You can use a five-minute epoxy that is clear and can be found in a hardware store. The epoxy hardens up again when it cools. Now you know all that is necessary to affix the scales to the shank of your knife.

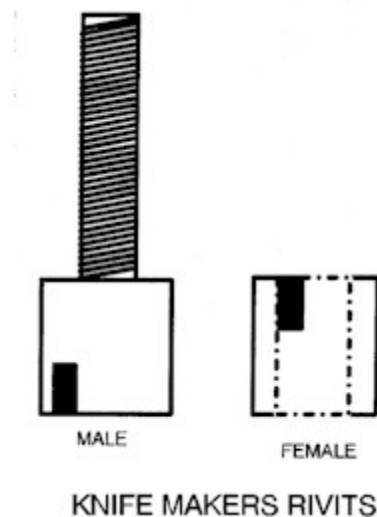

Clean the glue surfaces off with acetone. Mix the epoxy thoroughly and apply it lightly to both surfaces. Coat the pins or rivets. Place the slabs against the shank and set the rivets or pins.

Tighten the C clamps onto the handle, but be very careful. If you have a bolster, start with the lengthwise clamp and clamp the scales lightly against the bolster. When the slabs tighten up against the bolster, take the handle out of that clamp and clamp the sides of the handle with three or four small C clamps.

# THE ADVANCE KNIFE MAKERS MANUAL

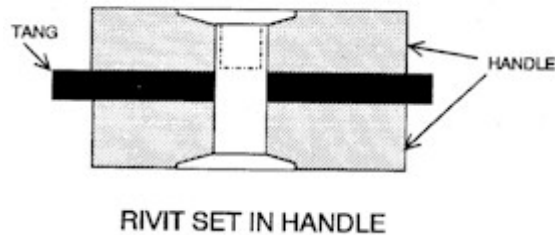

Epoxy should be squeezing out from around the scales, but watch the epoxy until it begins to set up, as the clamps may slip out of position, messing up the alignment of the scales.

## SHAPING THE HANDLE

The belt sander is what I use for shaping the handle quickly. Make the surface of the handle and the tops of the rivets flush. Do not take too much off the heads of the rivets. You will be going over them three or four more times, so leave enough material on them.

Rough shape around the edges, forming the handles basic shape and making the steel flush with the scales. Use a coarse grit belt for the first shaping processes, about 36 grit. We now file and sand the outer edge of the handle to make it flush with the steel of the tang. We then refine and rounded the shape of the handle with rasps, files, and sandpaper.

If you have a belt sander with a narrow belt, there may be a space where the belt is free from the metal backing. If so, this will be invaluable for finishing the underside of the handle.

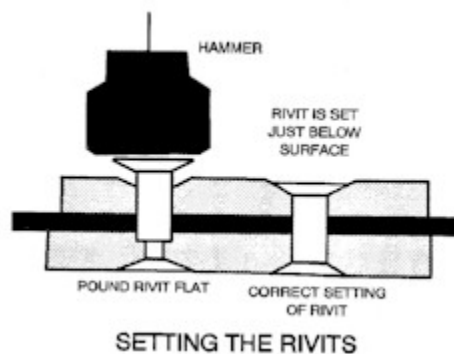

## FINGER GRIPS

If you want fingers to grip, the Wilton Belt sander will cut these as it has rollers down to 1". Form the finger grips as neatly and precisely as possible. You want the depressions to be rounded but the ridges to be well defined, not just lumps.

# THE ADVANCE KNIFE MAKERS MANUAL

## ONE PIECE HANDLE

We can make a one piece handle from just about any kind of material such as bone, horn, wood, or plastic. Lets start by making a handle from a piece of stag antler; the piece you use will be the butt end of an antler that is about 1 inch in diameter.

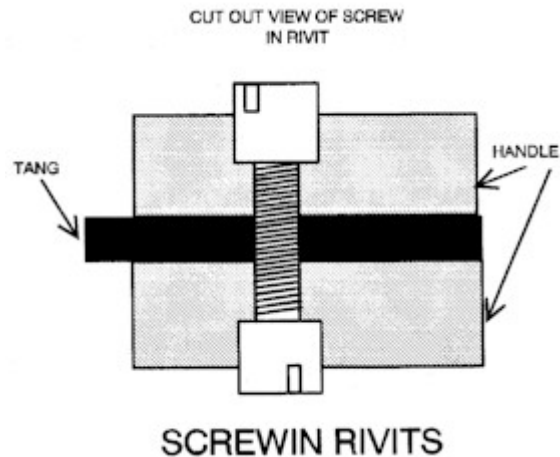

Place the knife next to the antler and decide where to saw it off, and at what angle. Cut the antler, leaving an extra 3 inch or so for adjustment. With the belt grinder, carefully bevel off the end where we have cut it so that the antler will butt properly against the bolster.

Find a drill bit that is about the same diameter as the tang. Drill a hole into the antler to receive the partial tang. Be careful when you drill this hole so that it will be in the right spot on the antler, and more important at the proper angle. Put the handle on the blade to see if it fits all the way up to the bolster? You may need to redrill and enlarge the handle or even bevel off the tang. Be sure the hole is deep enough, but be careful not to drill through the side of the antler.

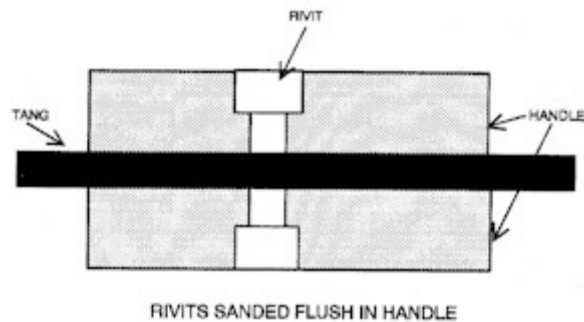

The antler needs to be squared off the end of the antler so it butts perfectly against the hill. You may need to bevel the bolster so that it is flush with the antler.

Mix a suitable amount of epoxy cement to fill the hole in the handle. Be sure it flows all the



## THE ADVANCE KNIFE MAKERS MANUAL

way to the bottom no bubbles. Coat the tang with epoxy, and fit the handle in place. Make sure the fit is perfect, and that the handle is turned to exactly the correct position that you want. Place the knife handle in a vise, blade up, so the whole knife is balanced. Check the alignment every so often in case it drifts a little.

## FINISHING THE HANDLE

Sand down the bone and brass on the belt sander until they are flush, but be careful that you do not overheat the epoxy. Leave the look of the handle as natural as possible.

Resand the handle to a 240-grit texture, and then and then buff with 320 grit. The knife is ready to polish. Do not buff any type of bone with a dirty wheel or one that you use for buffing the knife with, as the dirt from the wheel will become gummed into the pores of the bone. Always use a completely clean buffing wheel for the bone.

## FILLING IN CRACKS

They make the best wood filler, in case you ever do need to fill a small space or two, from epoxy glue and the sawdust from the wood you are using. Take a piece of the wood and grind it with a new, fine grit belt, mix the dust half-and-half with mixed epoxy glue, and quickly press it into the crack.

We need no sealer on antlers, but if wood is used, we should seal it. I used an even mixture of linseed oil and varnish. We liberally rubbed the mixture on with a cloth and allowed it to soak into the wood for about half an hour. We then wiped the excess off, and allowed the finish to dry overnight and then repeated this three or four times. Several commercial preparations will also produce attractive and durable results.

## HAIRLINE CRACKS

If anytime you see a minute check in the wood that would be a structural weakness or even a minor eyesore, I use a super glue that is so runny; it is absorbed into the most minute crack or check.

The glue sold under many names, dries as hard as epoxy glue and effectively removes small cracks and checks from the knife handle. It dries clear and the crack or check it absorbs into is invisible. Super Glue is the only modern adhesive I know of that has this particular absorbent characteristic.

Between the 90 and 120 grit sanding steps, I inspect all the edges of the handle, and around the rivets or pins and any part that might contain the threat of a crack or check. Any suspicious mark gets a drop of Super Glue; then, I just sand the glue residue flush during the 120-grit step. This glue works well to fill any minute cracks next to a bolster in a folding knife.

Continue sanding the handle in finer grit steps, polishing up to a 240 or 320 grit. Buff the handle using the same stainless buffing compound used for the blade.

## FLAP SANDING THE HANDLE

## THE ADVANCE KNIFE MAKERS MANUAL

A Flap Sander is a revolving abrasive cloth that strikes the work piece at high speed, use it to sand the hollow areas of the handle. It imparts a very smooth finish to the handle, or with different types of abrasives, it can produce different effects on the handle, such as driftwood or a raised grain effect. The flap sander action is very much like the action of a sand blaster and imparts a very attractive finish for a work knife.

### **FINISH THE HANDLE**

After buffing the handle, I clean all the buffing compound and dirt from it and apply a heavy coat of a Danish oil or Tung Oil. I then let it soak into the wood, and the next day followed by a second coat in about a half-hour. After this coat soaks in for half an hour, I wipe as much of the oil off as I can with a clean rag and let it dry overnight. This oil penetrates the surface of the wood and hardens, sealing it against moisture, which is very important for wood that does not have any natural oils.

# THE ADVANCE KNIFE MAKERS MANUAL

## FITTING THE FOLDING KNIFE

This is the most difficult part of knife making. This is where you take all the parts, and fit it into a working knife. You take the handles, with the bolsters attached, the blade, lock and fit them together, but if you do not have the hinge pinhole drilled in the handle, do it now.

Take the template that you used to mark out the handle, and clamp it in place on the handle. If you are using a larger style knife, drill this hole with an 1/8-inch drill. Be sure that you clamp the template on the both front and back. I have had many handle templates move when I only clamped it in one place.

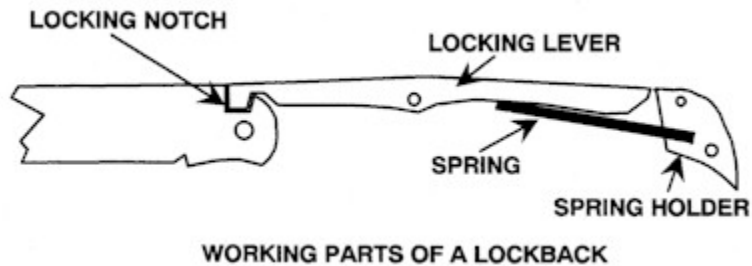

Turn on the drill press and slowly drill down through the hole in the template. Be sure that the drill bit is sharp, as I have had more than one bolster on small knives come off due to the heat buildup. The bolster will get hot enough to melt the solder if the drill is dull.

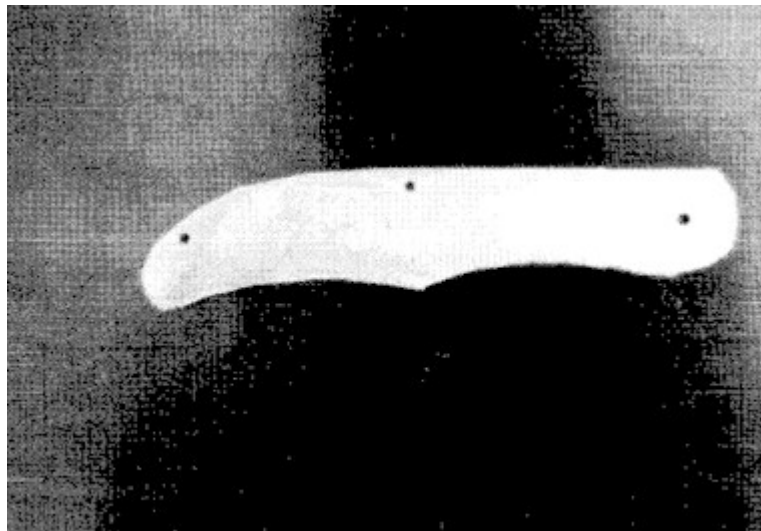

LINER AND HANDLE AFTER DRILLING

Now that you have the hole drilled, take the blade, lock, and put them together, clamping the blade in the vise holds them together. Take the lock, and gently tap in the notch on the blade. If it is fitted close, it will stick and stay in place.

## THE ADVANCE KNIFE MAKERS MANUAL

Remove the blade and lock from the vise. Attach the blade to the handle by inserting an c inch pin. Now that you have this together, and the blade with the lock attached, line up the lock on the handle.

Line the top of the lock with the top of the handle. Take a clamp, and clamp the lock to the handle.

Go to the drill press, and put a 3/32-drill bit in the chuck. Now very carefully drill through the hole that you have in the lock. Drill slowly through the liner and handle material. If you try to drill too fast, it will split the handle material when it goes through, just apply enough pressure to keep cutting, but do not force it.

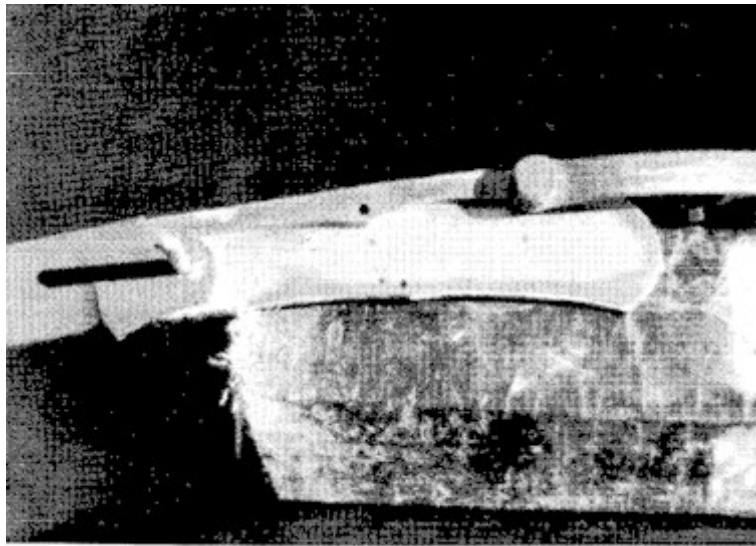

READY TO DRILL LOCK HOLE IN HANDLE

### FITTING THE LOCK TO THE HANDLE

When drilled through, remove the clamps and templates. Leave the lock attached to the blade. Insert a 3/32-inch pin through the lock and handle so you can fit the spring retainer to the handle.

Finishing the lock on the bottom side now, if you did not harden the lock when you heat-treated the blade, do it now. We can harden it with a welding torch, or if you are using O1 tool steels, with a butane torch. Always preheat the end where the lock is, and dip it in brazing a flux or anti-scaling compound.

If you have not done it yet, finish the thickness of the lock to .005-.006 smaller than the blade. You need the lock this much smaller so it does not bind up when you open or close the knife.

To do this, use the flat belt sander, and sand it down to the correct size. The blade is usually smaller than the lock, and spring retainer. The lock on the end, where you have the thumb

# THE ADVANCE KNIFE MAKERS MANUAL

recess cut, should also be a few thousands smaller for clearance.

When you have the lock taken down to size, put the worn-out 240 grit belt on the belt sander, and finish polishing the lock. Get a smooth a finish as possible. The smoother the finish the easier it will work, and the slower you will get wear.

## FITTING THE SPRING RETAINER

Finish the metal on this retainer on the part that will be on the inside of the handles. The surface should be flat and square. This can be done on the end of the belt sander.

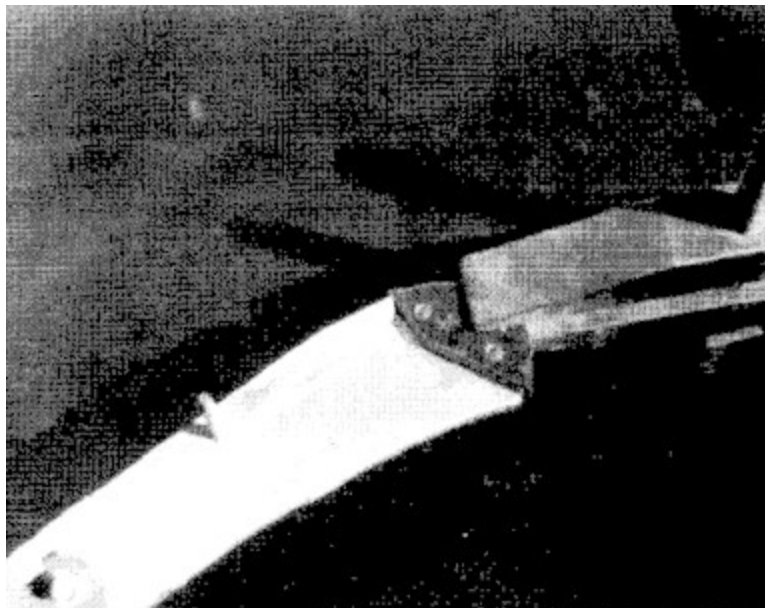

READY TO DRILL SPRING HOLDER

Set this on the end of the knife handle, and against the end of the lock. Mark where you want to drill the holes (two). We should drill the holes so they come no closer than an c inch from the outside edge of the handle.

Be careful that you do not drill the lower hole where the spring will be. You will look at the template to find this. The holes marked on the patterns should be close enough so there would be no problems.

## DRILLING THE HOLES

Drill these holes with a 3/32-inch drill also. **BE CAREFUL HERE AS THIS RETAINER CAN GET AWAY FROM YOU AND CUT YOU AS IT SPINS AROUND.**

I always hold the spring retainer with a vise grip or pliers, and even then, it will sometimes get away from me, so drill slowly and there should be no problems.

## THE ADVANCE KNIFE MAKERS MANUAL

After we drill the holes, remove any burrs with a file. Have the blade and lock in position on the handle. Place the spring retainer on the handle, butting it against the end of the lock. Clamp the retainer in place, being sure that you leave enough clearance so you can drill one hole in the handle. Go to the drill press and use the same drill bit that you used to drill the first holes.

### DRILLING THE HANDLE

Carefully drill down through the hole, and through the handle. Go through the handle material slow so you do not cause it to chip when it emerges on the other side. This is especially important if you are drilling bone, ivory, pearl, etc.

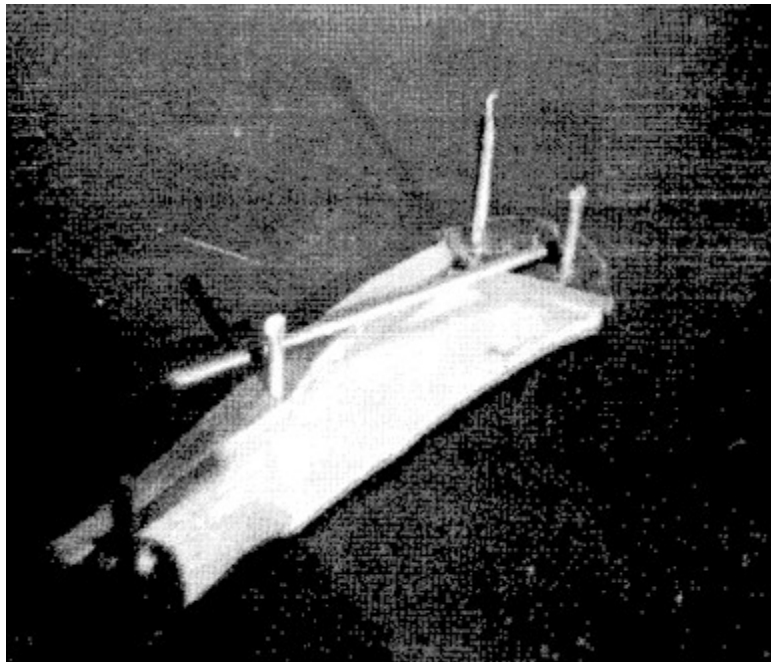

MARKING SPRINGHOLDER FOR CUTTING SLOT FOR SPRING

With the first hole drilled, remove the clamp and insert a pin in the hole to attach the spring retainer to the handle. Now get it lined again, and clamp it in place. Drill this hole and when completed, put a pin in place.

### FITTING THE SPRING

You will need a piece of spring stock .093 thousands in diameter for the lock spring. This can be purchase from Brownells.



## THE ADVANCE KNIFE MAKERS MANUAL



SLOT CUT FOR SPRING

With the knife pinned and locked in the open position, take a piece of the spring wire and mark the retainer. Holding the spring on the angle over the lock, and on the retainer, then with a scribe, and mark the retainer (spraying Dykem on the retainer is done so you can see the mark).

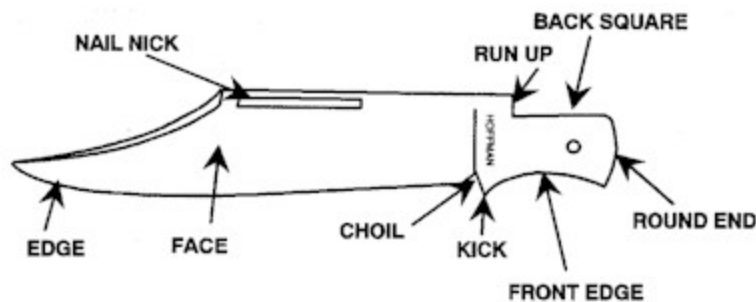

PARTS OF A BLADE

We should position the spring so that it will be in the proper place on the lock; this is about a third of the distance back from the hole in the lock. You have to be sure there is enough clearance between the lock and spring, so when we unlock the knife it will not hit the spring.

When you have it marked, remove it from the handle and drill a hole where you want the end of the spring to be. Use a center punch and about 3/8 to 1/2 inch from the inside edge, carefully center punch it in the center of the spring retainer.



## THE ADVANCE KNIFE MAKERS MANUAL

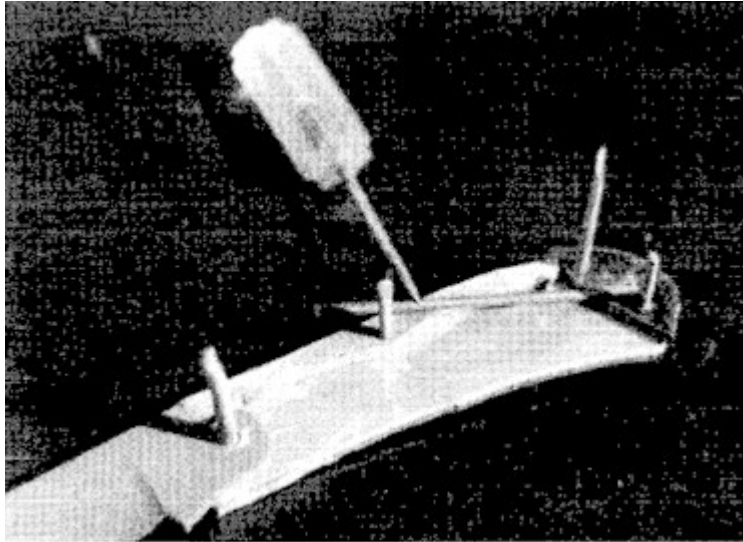

SHOWING WHERE TO CUT OFF SPRING

Go to the drill press again, and drill the 3/32 hole where you center punched it. The next thing to do is to cut the slot on the band saw, but be very careful doing this, as your fingers are very close to the blade. Cut to the inside of both lines, and be sure that you will have enough metal left to file the cut marks flat. When you file it flat, you will also have to fit the spring to this slot so it will be a close snug fit. You will use thin needle files for this purpose.

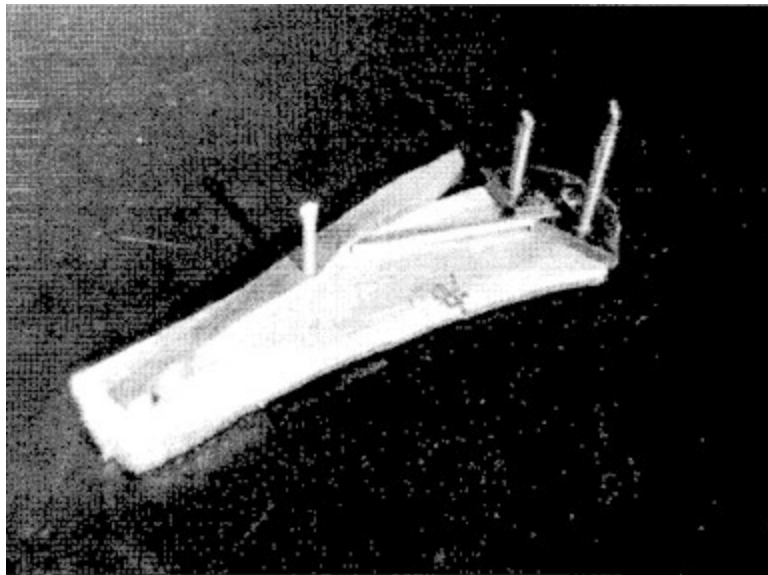

SPRING SET AT PROPER ANGLE TO LOCK

When the spring fits snugly, hold the retainer with the spring in place over the holes in the handle. Take a pencil and put a mark on the spring at the place that we will cut it off, but do not worry if you did not get the slot in the right place, and the spring is too low.

Clip off the wire with a side cutter. Go to the belt sander and bevel the ends of the wire so there will not be any sharp edges. If the spring is too low, and it does not touch the lock, this

## THE ADVANCE KNIFE MAKERS MANUAL

will be easily corrected. Place the spring in the vise and bend it up slightly. Make the bend close to the retainer, but not next to it.

# THE ADVANCE KNIFE MAKERS MANUAL

## FITTING THE HANDLES TOGETHER

Now that you have the holes drilled, drilling the holes in the other handle will be necessary. To do this, carefully line up the handles and clamp them. Go to the drill press and drill through the existing holes. Now you can put the knife together and fit the blades.

## FINISH FITTING THE KNIFE

Make sure that you have enough line up pins. You will need three 3/32-inch pins, and one 1/8-inch pin. Take one handle and insert a pin into a hole that holds the spring retainer. Set the spring retainer on the pin, and stick a pin into the other hole.

Take the other handle, and put it together on the pins, then take the lock and slip it between the handles and pin it. When you press the rear of the lock down, you should fill the spring pressure. Finish pushing it into the handle to be sure there is enough clearance on the spring retainer. If there is not, remove a little metal from the backside of the lock.

If everything fits well, take the blade, slip it in place, and pin it with an 1/8-inch pin. The lock should be all the way down in the notch blade. To be sure, use a small punch on the back and tap the lock all the way down.

Take a small C clamp and clamp the knife together on the bolster. This is to insure that the lock stays in place when you flatten out the back of the knife.

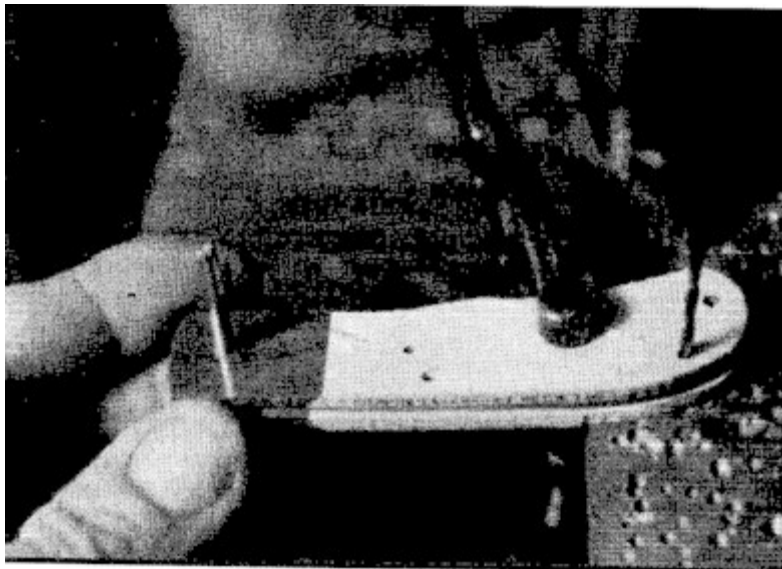

DRILLING HOLES IN OPPOSITE HANDLE

# THE ADVANCE KNIFE MAKERS MANUAL

## FINISHING THE OUTSIDE OF THE KNIFE

Use thirty-six grit belts on your belt sander (the 6 x 48-inch belts) for flattening the outside areas of the knife. If the style of the knife is such that it is flat on the back, flatten the back of the knife first. Remove the metal so there are no blade marks left on the back.

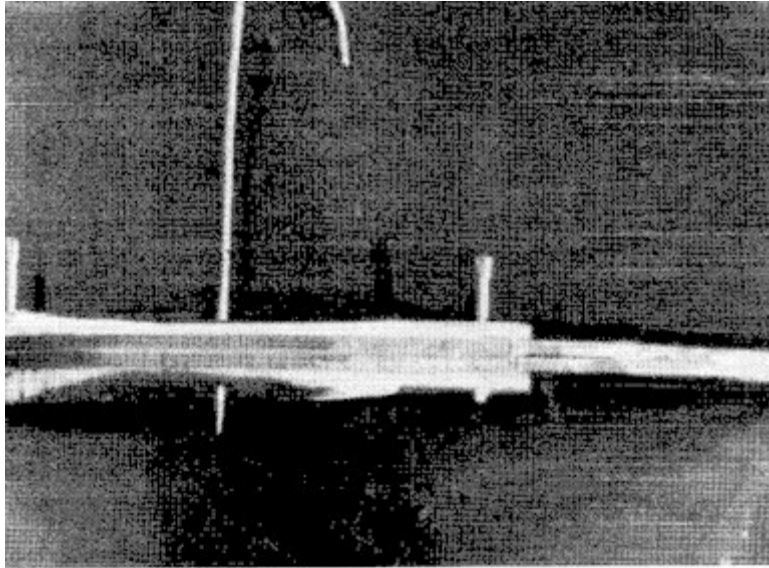

*LINE-UP PIN USED WITH EITHER LOCK OR SPRING BACK KNIVES*

Usually, there will be enough material so the outside area can be cleaned up without having to take off much from the handles. When the back of the knife is flat, and (this should include the rear of the blade) slowly clean up the rest of the knife. With this coarse a belt, just take enough to get to the liner or handle.

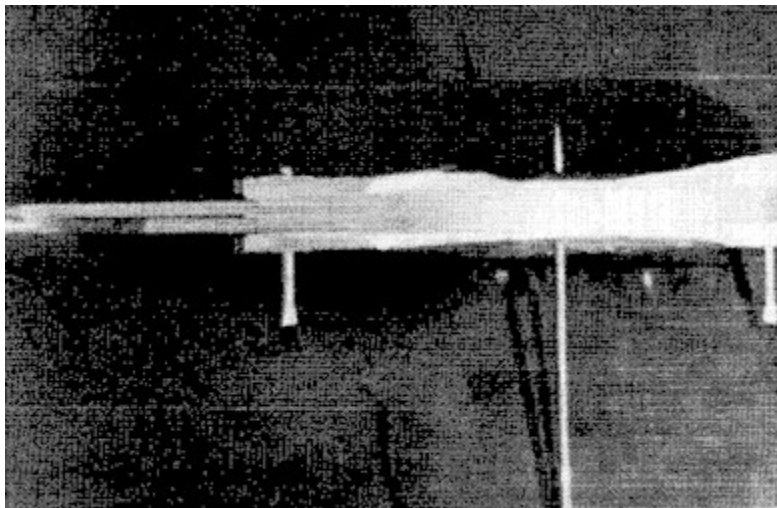

*BACK OF KNIFE SANDED SMOOTH*

## THE ADVANCE KNIFE MAKERS MANUAL

If you are making a lock back, it is now time to cut the finger recess in the rear of the knife where you will open it. Pull the pin that holds the lock in place and remove the lock. If you have the Wilton square wheel grinder, use the 1-inch roller for cutting this groove.

Very carefully, grind a groove in the back of the handle. Take the edge of this groove right up to the edge of the spring retainer, but not touching it. Cut it only deep enough so when the lock is pressed down it will unlock the blade.

When completed, take the knife apart, remove all the burs, and reassemble it without any knife parts. The reason for this is to be able to finish the outside of the bolster area. Go back to the thirty-six-grit belt sander (6 x 48 belt) and carefully finish the bolster area.

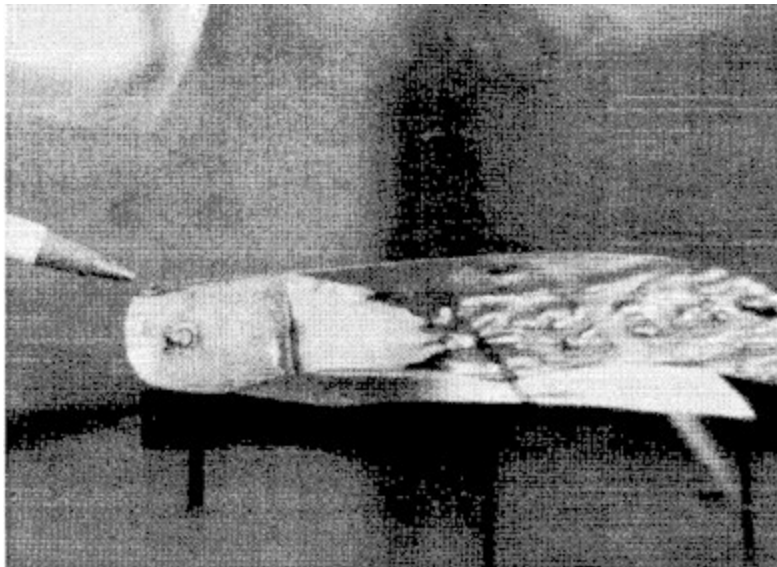

KNIFE CLOSED SHOWING SPRING AND BLADE PROTRUDING

Be very careful that the bolster does not overheat, as the solder will melt. Dip the bolster area in water every few seconds to keep this from happening. When completed, use a 180 or a 240-grit belt to finish the outside of the handles, however do not do anything on the back for now. When you assemble the knife again, and then finish the back of the knife.

### FITTING THE BLADE

Reassemble the knife again, and making sure that we have fully seated the lock. Go to the belt sander again and flatten the back again with 180 or 240-grit belt. This has to be fitted flush so you can get a good closing fit on the blade.



## THE ADVANCE KNIFE MAKERS MANUAL

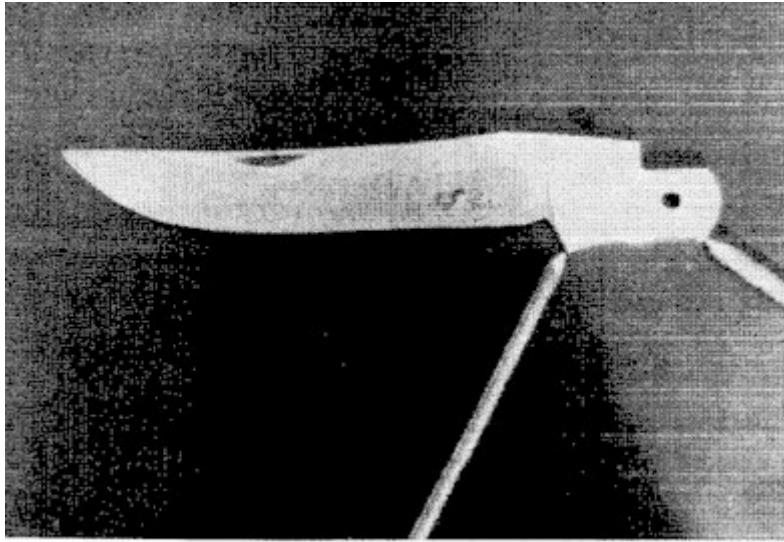

POINTS TO REMOVE TO FIT BLADE

Now close the knife blade in the handle and see how much we should remove to get the proper fit. If you have left enough metal; we should raise the lock area  $1/32$  to  $1/16$  inch above the top of the handle in the bolster area. In addition, the blade should not be fully closed in the handle in the kick area (see picture) we should remove the metal to make the knife close. Just remember taking metal off the kick will cause the blade to close more in the handle.

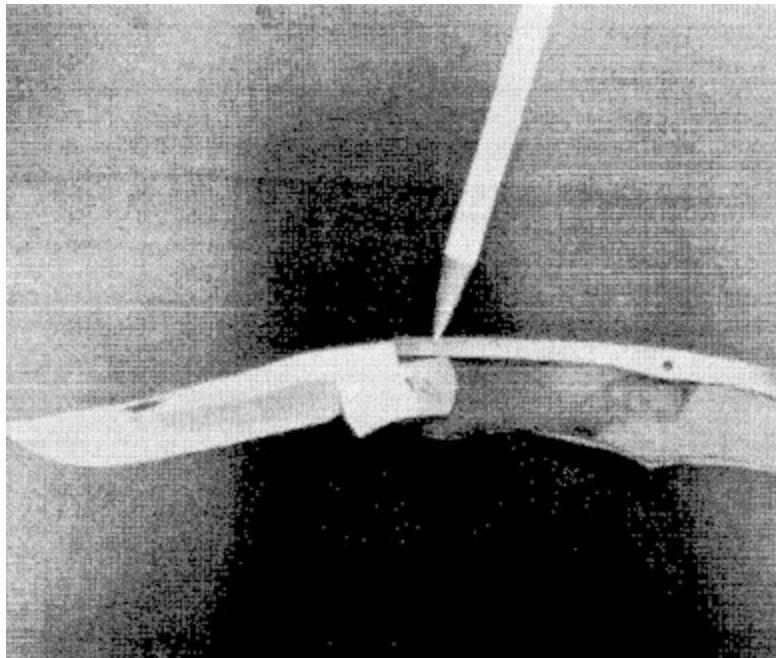

FITTING THE SPRING

Taking metal off further back near the round part of the blade, will cause the lock to come back to flush when the blade is closed.

## THE ADVANCE KNIFE MAKERS MANUAL

If the lock is extending a 32 of an inch or more, take metal off the kick area to lower the blade in the handle. This is done on the end of the 6 x 48 belt sander using a fine grit belt; use the radius that the roller of the sander will give you. From now on, it is trial and fitting, take off a little and then put the knife together and check the fit.

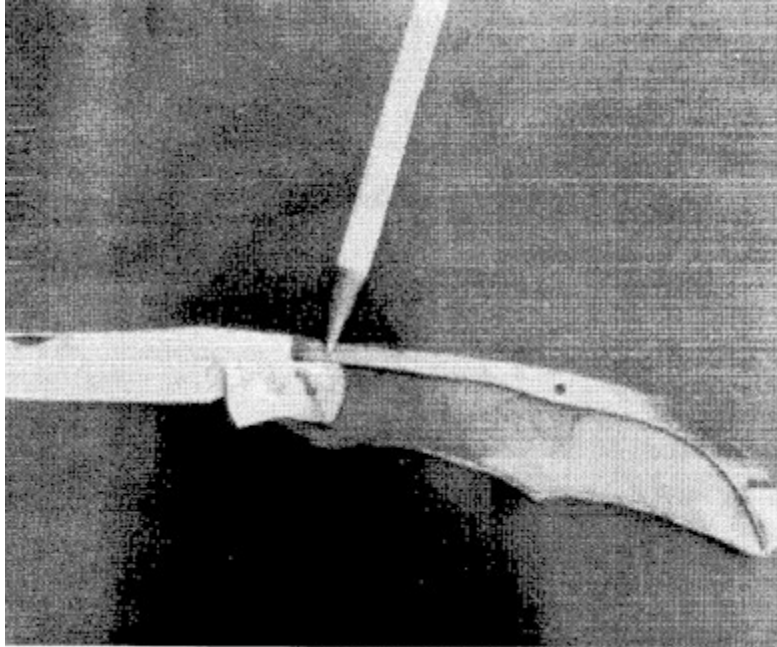

PROPER FIT OF SPRING

If the blade closes too much, and the lock is not flush, do not worry as it can probably be corrected. How can this be done? If you can remove a little more metal from the back, this will raise the blade a little.

If the lock goes below flush on the back of the blade when it is closed, you have a problem. The only way you can correct this is to have the lock seat deeper when the blade is open. Using an Arkansas stone, very carefully remove a little metal from the front of the lock.

When you get it to recess enough, flatten the back of the knife a little more so it will be flush. When you have the back flush when the knife is both open and closed, it is time to finish the blade for final fitting.

### FITTING THE SPRING BACK

You need to get the end of the spring the right length now before you fit the blade. Now, pin the blade in the handle, and the spring in the rear hole. With the spring in the notch of the blade, see how much the blade is pointing downwards.

## THE ADVANCE KNIFE MAKERS MANUAL

It wants to be pointing down two to five degrees on a spring back. If it is pointing downward more than that, you should take a little metal off the front of the spring until you get the right angle.

Do this a little at a time until you get it right. Remember that when we assemble the knife with a line up pin in the center hole, the blade will angle down 1 to 2 degrees more.

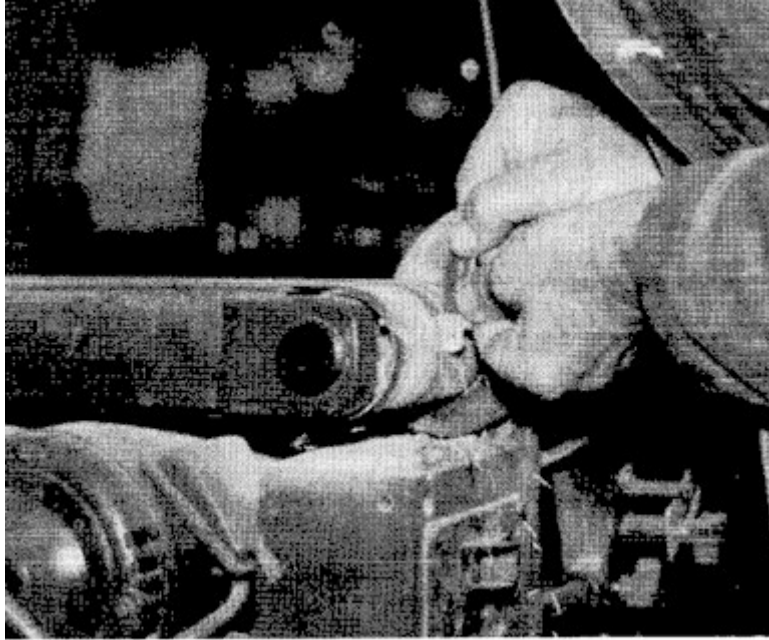

GRINDING THE KICK AND ROUND AREA IN FITTING

You need a line up pin, made from 3/32-inch spring wire and sharpened on one end, with an d inch taper. The end should be bent to a T shape so we can push it into the drilled hole.

When you have the line up pin made, assemble the knife, and clamp the handle in the vise so the spring is compressed a little. Now insert the pin through the hole in the handle and the spring. Once you have this done, finish the knife as you would a lock back. The exception is that you should clamp the spring every time to remove the line up pin.

### FINISHING THE BLADE

Now that the blade is fitted, you can finish the blade for final assembly. There are three options open to you for the blade finish.

1. The standard way to finish the blade is to polish it to a high finish. This is OK for a show knife, but for a work knife the finish will look bad in a year or so of use, what happens is the blade gets all scratch up with use.



## THE ADVANCE KNIFE MAKERS MANUAL

2. If you want a work knife, you may want to use the Matte or soft satin finish. This finish is very rugged, and will not show many scratches due to hard use.

3. The third finish is for carbon tool steel and is a soft satin finish. Then after matting, we plate it with a corrosion resistant coating. I have used a coating called Marine Tuff for three years now on carbon steel with no rusting problems. An Electroless nickel process sold by Brownells is very good and will give you the same protection.

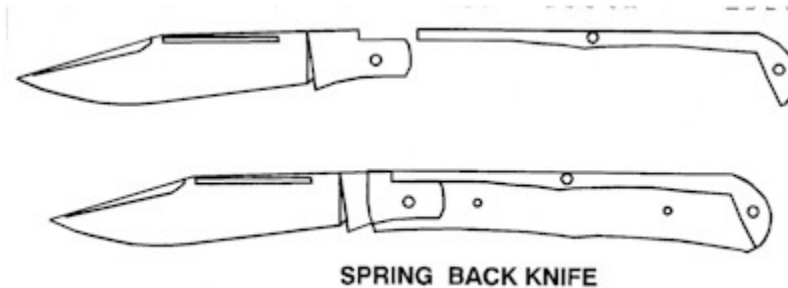

If you are going to polish the blade, it must be free from sanding belt scratches. When you are finish grinding the blade, you should use several grits sizes of belts. Each size should finish the blade a little finer.

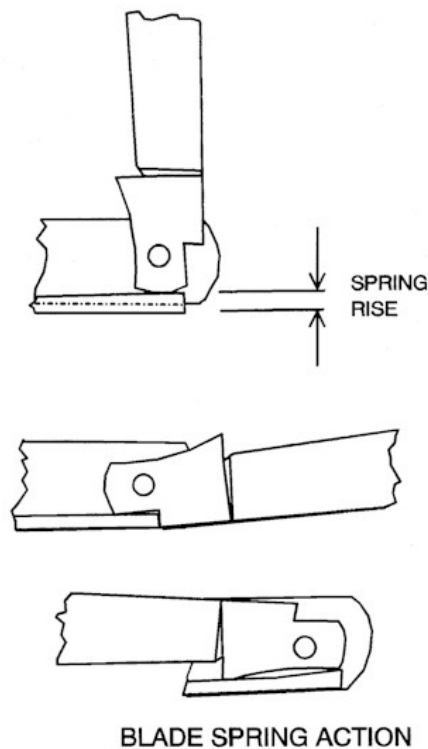

Make sure that you remove the previous grinding marks before you go to the next finer belt. Be careful that you not change the lines of your knife as you grind. Occasionally, look down the length of the blade from the top to be sure that we center the point of the blade.

## THE ADVANCE KNIFE MAKERS MANUAL

Finish the blade with 400 grit, and it will be ready to polish. They also make a cork belt that you put buffing compound on. This belt will remove many of the small shallow scratches.

If you want to eliminate much of your polishing, they even make belts with grits of 600 to 800. This will really put a fine polish on the blade. The one draw back of polishing the blade is, it will take an hour or so to do the job.

This translates into a higher cost on the finish product. This is important to remember, as the higher the cost, the harder it is to sell, and with a Matte finish, I can finish a blade in less than twenty minutes. When you have gotten the blade as good as you can on the belt grinder, you can then go to the buffing wheel for the final finishing.

Use a stitched buff in buffing with a good compound. For stainless steel they sell an aluminum oxide grease base compound to finish the blades. A good source for this is K & G Finishing Supplies (See Appendix). They have a choice of twelve different abrasives from which to choose, and they have just about everything that you would need to make knives.

Start with the coarser grits, and work up to the finer grits. Be careful about over polishing as you can get an orange peel finish.

When polishing blades, be extra careful so the blade does not catch the buff, always polish the lower half or three quarters of the blade, then flip it over and do the other side. If you let the top edge encounter the buff, it will grab the blade with such force; it can do serious harm.

**DO NOT** polish the blade if the edge is sharp. Always take the edge off first.

**DO NOT** hold on to the blade by the cutting edge, as it may grab and take your fingers off.

**DO NOT** have your feet under the blade when polishing. You might just have the blade sticking from your foot if it grabs and jerks from your fingers. I have had blades grab, and hit the floor so hard that it broke in two pieces, and chipped the floor.

If you can find meat cutters gloves, certainly buy them. They may just save you a trip to the hospital to sew the finger or fingers back on.

This is the most dangerous area of knife making. More accidents have happened here than in any other part of knife making.

### **SATIN FINISH**

The satin finish is for me the best and most practicable way to finish the blade. For a work knife, this finish is very hard to beat. To satin finish a blade, you will need a small bead blaster. Most industrial supplies outlets sell these. Get a bag of fine mortar sand from a

## THE ADVANCE KNIFE MAKERS MANUAL

building supply outlet. You can make up a large container to reuse the sand, or use a small container and bead blast the blade outdoors.

Make sure that your air compressor has at least 80 lbs. of pressure, and better yet 100 lbs. Put on a dust mask, and holding the blade about 4 inches away from the nozzle. Squeeze the lever and matte the blade evenly on both sides. Hold the blade up to the light to check to see if you missed any spots.

The finish should be even over the entire blade, but this finish is normally too coarse to look good. This is why I use a wire wheel to finish it. This finish will hold oil to help protect it from rusting. I have also used an auto wax on the blade to protect it from bloodstains, etc. This makes an excellent finish for stainless tool steels.

## FINISH GRINDING OF THE BLADE

Now that the blade is heat treated, you can do the finish grinding. You will need to flatten the blank on the belt sander.

When, I flatten out the blade; I will finish out the sides completely. I start with 36 grit on the flat belt sander, to flatten the blade. Then I use 180 grit to remove the grind marks, and finish with 240 grit.

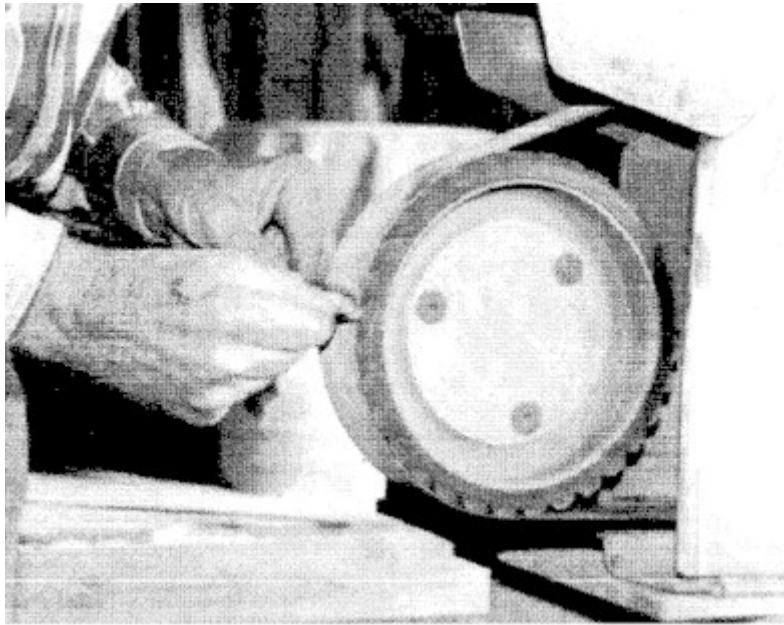

FINISH GRINDING THE BLADE

When, I flat grind the blade, I make sure that the topside of the blade where the lock area is .004 - .005 thousands thicker than the kick area. The reason for this is that you need this clearance so the knife will close easily. If you leave it flat, it will bind in the handle.

For the final finishing, I use a worn out 240-grit belt; I then coat the belt with white buffing compound. I can then finish the blade to a high finish.

Make sure that all the grind marks are out of the blade, or they will show up when the knife is finished. This is important so you can mark the scribe lines on the blank for grinding. To do this, clean up the blade so all the scale is removed. This is done with a wire brush; on a grinder, buffer, or drill press but it needs to be cleaned up enough so that Dykem will stick.

Once the Dykem has been applied and it is dry, you can mark the grind marks. We should mark the grind marks very carefully. These lines will show you how far to finish grind the blade. Several suppliers in the back of this book carry special tools to mark the blade. If you have a good eye, you can grind the blade even without using the scribe lines.

# THE ADVANCE KNIFE MAKERS MANUAL

## GRINDING THE BLADE

I usually start using 36 grit. This will true up the blade if there is any warping. You can probably grind the blade close to the finish size. We should grind the cutting edge of the blade now to .020 - .025. All the time that I am grinding the blade I hold it with my fingers. I do not hold the blade with any tool, such as vise grips.

Why don't you hold the blade with Vise Grips? When I am holding the blade with my fingers, I can feel the heat build in the blade. When it gets hot, I dip the blade in a water container that I keep next to the grinder.

If I held the blade with Vise Grips, I would probably burn the blade. This would remove the temper, and soften the blade. I cannot stress the importance of not over heating the blade. When you go to all the trouble of making a blade, then you draw the temper when grinding; you wasted all your work.

If you see any color from a heat buildup, you have gotten the blade too hot and you will soon learn how fast the blade heats up, and when to cool it. When grinding the cutting edge and point, be very careful, as it only takes seconds to heat. Stainless is bad about softening.

After rough grinding with 36 grits, put a 180-grit belt on the grinder. Repeat the process, and remove the 36 grit grinding marks from the blade. Be extra careful from now on, so you do not make any unnecessary mistakes.

## FINISHING THE BLADE

Repeat the process with 240, 320, and 400 grit belts, and when you have finished with the 400-grit belt, the blade should have a very good finish. You must be sure that the finish blade has a thickness of less than .020 on the cutting edge. This thickness is what makes a blade cut well and hold a good edge, but any thicker, sharpening it will be hard, will not hold an edge good, and probably wont cut good.

The exception to this, is when you want a knife that you can split game with, and on this kind of knife, the blade can be left .030 - .035 on the cutting edge. This type of blade will not hold an edge too good, but it will be a much stronger knife.

## MAKING A WORK BLADE

When you are making a knife for this purpose, you should also do another step. With the blade polished, take a butane torch and draw the temper on the back of the blade.

This is done by using a small flame on the back of the blade. Start in the lock area, and holding the **EDGE** of the flame on the spine, or edge. As the edge heats, you will see color starting to appear on the blade. Do not let this color go to the cutting edge.

The color on the back of the blade should be purple and light straw about **HALFWAY** to the cutting edge. This will take some practice, and it is best done on an old blade first. Keep a pan of water handy as you draw the back. If the color is getting too close to the cutting edge, dip the cutting edge in the water.

Draw the temper all the way down the blade. Dip the cutting edge into the water anytime the color is getting past **HALFWAY**. When done, you will have a blade that is very tough, but with a hard edge. We can abuse this type of knife (Heaven Forbid) without too much chance of breaking. This method can only be used with carbon steels. On any type of stainless steels this will not work.

With this done, we can now go to the fitting of the blade.

## SHAPING THE HANDLE

The belt sander is what I use for shaping the handle quickly. Make the surface of the handle and the tops of the rivets flush. Do not take too much off the heads of the rivets. You will be going over them three or four more times, so leave enough material on them.

Rough shape around the edges, forming the handles basic shape and making the steel flush with the scales. Use a coarse grit belt for the first shaping processes, about 36 grit. We now file and sand the outer edge of the handle to make it flush with the steel of the tang. We then refine and rounded the shape of the handle with rasps, files, and sandpaper.

If you have a belt sander with a narrow belt, there may be a space where the belt is free from the metal backing. If so, this will be invaluable for finishing the underside of the handle.

## FINGER GRIPS

If you want fingers to grip, the Wilton Belt sander will cut these as it has rollers down to 1". Form the finger grips as neatly and precisely as possible. You want the depressions to be rounded but the ridges to be well defined, not just lumps.

## ONE PIECE HANDLE

We can make a one piece handle from just about any kind of material such as bone, horn, wood, or plastic. Lets start by making a handle from a piece of stag antler; the piece you use will be the butt end of an antler that is about 1 inch in diameter.

Place the knife next to the antler and decide where to saw it off, and at what angle. Cut the antler, leaving an extra 3 inch or so for adjustment. With the belt grinder, carefully bevel off the end where we have cut it so that the antler will butt properly against the bolster.

Find a drill bit that is about the same diameter as the tang. Drill a hole into the antler to receive the partial tang. Be careful when you drill this hole so that it will be in the right spot on the antler, and more important at the proper angle. Put the handle on the blade to see if it fits all the way up to the bolster? You may need to redrill and enlarge the handle or even bevel off the tang. Be sure the hole is deep enough, but be careful not to drill through the side of the antler.

The antler needs to be squared off the end of the antler so it butts perfectly against the hill. You may need to bevel the bolster so that it is flush with the antler.

Mix a suitable amount of epoxy cement to fill the hole in the handle. Be sure it flows all the way to the bottom no bubbles. Coat the tang with epoxy, and fit the handle in place. Make sure the fit is perfect, and that the handle is turned to exactly the correct position that you

# THE ADVANCE KNIFE MAKERS MANUAL

want. Place the knife handle in a vise, blade up, so the whole knife is balanced. Check the alignment every so often in case it drifts a little.

## FINISHING THE HANDLE

Sand down the bone and brass on the belt sander until they are flush, but be careful that you do not overheat the epoxy. Leave the look of the handle as natural as possible.

Resand the handle to a 240-grit texture, and then and then buff with 320 grit. The knife is ready to polish. Do not buff any type of bone with a dirty wheel or one that you use for buffing the knife with, as the dirt from the wheel will become gummed into the pores of the bone. Always use a completely clean buffing wheel for the bone.

## FILLING IN CRACKS

They make the best wood filler, in case you ever do need to fill a small space or two, from epoxy glue and the sawdust from the wood you are using. Take a piece of the wood and grind it with a new, fine grit belt, mix the dust half-and-half with mixed epoxy glue, and quickly press it into the crack.

We need no sealer on antlers, but if wood is used, we should seal it. I used an even mixture of linseed oil and varnish. We liberally rubbed the mixture on with a cloth and allowed it to soak into the wood for about half an hour. We then wiped the excess off, and allowed the finish to dry overnight and then repeated this three or four times. Several commercial preparations will also produce attractive and durable results.

## HAIRLINE CRACKS

If anytime you see a minute check in the wood that would be a structural weakness or even a minor eyesore, I use a super glue that is so runny; it is absorbed into the most minute crack or check.

The glue sold under many names, dries as hard as epoxy glue and effectively removes small cracks and checks from the knife handle. It dries clear and the crack or check it absorbs into is invisible. Super Glue is the only modern adhesive I know of that has this particular absorbent characteristic.

Between the 90 and 120 grit sanding steps, I inspect all the edges of the handle, and around the rivets or pins and any part that might contain the threat of a crack or check. Any suspicious mark gets a drop of Super Glue; then, I just sand the glue residue flush during the 120-grit step. This glue works well to fill any minute cracks next to a bolster in a folding knife.



# THE ADVANCE KNIFE MAKERS MANUAL

Continue sanding the handle in finer grit steps, polishing up to a 240 or 320 grit. Buff the handle using the same stainless buffing compound used for the blade.

## FLAP SANDING THE HANDLE

A Flap Sander is a revolving abrasive cloth that strikes the work piece at high speed, use it to sand the hollow areas of the handle. It imparts a very smooth finish to the handle, or with different types of abrasives, it can produce different effects on the handle, such as driftwood or a raised grain effect. The flap sander action is very much like the action of a sand blaster and imparts a very attractive finish for a work knife.

## FINISH THE HANDLE

After buffing the handle, I clean all the buffing compound and dirt from it and apply a heavy coat of a Danish oil or Tung Oil. I then let it soak into the wood, and the next day followed by a second coat in about a half-hour. After this coat soaks in for half an hour, I wipe as much of the oil off as I can with a clean rag and let it dry overnight. This oil penetrates the surface of the wood and hardens, sealing it against moisture, which is very important for wood that does not have any natural oils

## COMPLETING THE KNIFE

If you have all the parts finish and ready to go, we can put the knife together. There are two ways to finish the outside of the handles.

1. After all the pins are in place the knife is placed on the belt sander, and the handles are finished flat. This gives an squarer handle that is not too comfortable, and a little hard on the pocket.

I do use this style some, as it is a little easier to hold on if your hands are cold and bloody. This style is a good candidate for a belt sheath.

2. The other way is to bevel the sides on the Wilton belt grinder. This puts a gentle radius on the out side of the knife that is very easy on the pocket. It will also make a neater and attractive knife.

If you choose the second option, the handles, and bolsters will need to be rough radius before putting the knife together.

The holes on the outside of the handles should be counter sunk a few thousands. These countersinks can be purchase at any hardware store. The reason for this is when you peen the rivets, they will fill the counter sunk and hold the knife together.

## THE ADVANCE KNIFE MAKERS MANUAL

Get a piece of 3/32 and 1/8 inch nickel silver rod or wire for the pin. Hold the spring retainer (if it is a lock back) or spring against the handle. Insert the 3/32-inch rod in the appropriate hole in the handle. Push it through the spring or spring retainer, and the other side of the handle.

Take a side cutter and clip off the rod, leaving about 3/32 inch sticking out on both sides. If you are working on a lock back, stick the pin into the other hole and clip off.

Now insert the lock in place and insert the pin in place, and clip it off. If you are making a spring back, do not pin the spring (in the center) yet.

Take the blade and line it up with the hinge hole and insert a 1/8-inch rod in place, and clip it off. Test the knife to be sure everything is fitted, as it should be.

If you are putting a spring back together, clamp the knife in a vise to compress the spring. Insert the steel line up pin in place to adjust the spring. Take the 3/32-inch nickel silver rod, and put a slight taper on one end.

This is to help you get it through the handle, as it will be a tight fit. Put a drop of oil on the pin, and then remove the line up pin. Start the nickel silver rod into the hole, and push it as far as you can. Pliers or vise grips can be used to help you work the rod through the handle.

When you have it sticking out about 3/32 inch, clip off the rod. Open and close the blade to check to see if the fit is OK.

# THE ADVANCE KNIFE MAKERS MANUAL

## RIVETING THE KNIFE TOGETHER

You will now need to grind the pins off so they can be peened. The belt sander can be used for this. All the pins except the hinge pin should be ground off so only about .015 are protruding.

The hinge pin is left with about 1/16 inch protruding on each side. The reason for this is with the slacking tool inserted you will need enough pin to fill out the counter sink.

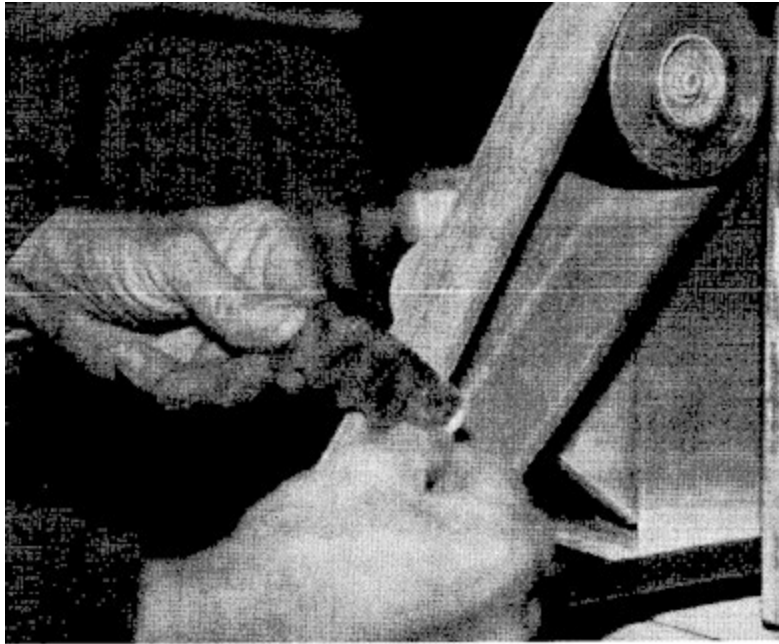

PUTTING RADIUS ON HANDLE

Take a small ball peen hammer, and with the knife lying on its side on an anvil, peen the rear pins. This is done by tapping the pins on the outside edge all the way around the pin. When the pin is rounded slightly, turn over the knife and do the other side. Keep rotating and peening a little more at a time until the pins are tight.

Do not over peen, as you stand a good chance of splitting the handle material. Peen them just enough to make them snug.

## DO NOT PEEN THE CENTER PINS UNTIL LAST

On the lock back, test the lock to see that it is not binding up. If it is, you may have to take off a little more metal on the table sander.

## PEENING THE BLADE

If the lock is working OK, push out the hinge pin slightly so a sealer can be put on the pin. The

## THE ADVANCE KNIFE MAKERS MANUAL

sealer that I use is Loc-tite, and it is used to keep the pin from moving.

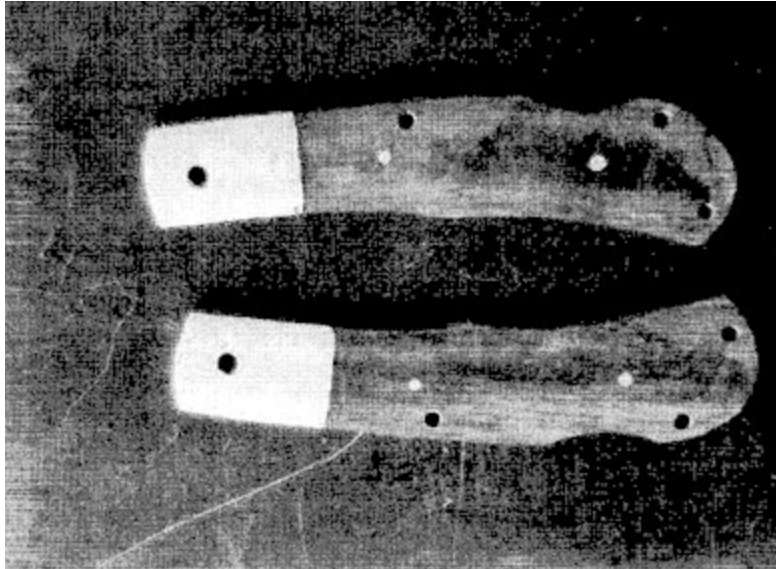

HANDLES WITH ROUGH GROUND RADIUS

With the pin recessed on one side about 1/16 of an inch, put a SMALL amount in the hole. Do the same on the pin on the other side.

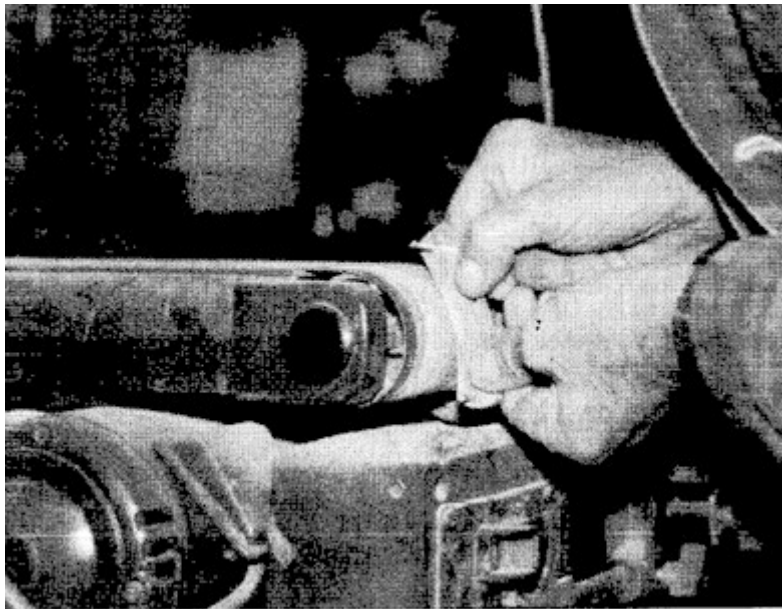

FINE GRIND THE OUTSIDE OF HANDLE

**DO NOT LET THE LOC-TITE GET DOWN TO THE BLADE.** If this should happen, the blade will open and close very stiffly, or not at all.

### USING THE SLACKING TOOL

Close the blade up half way, and place the slacking tool between the blade and the liner.

## THE ADVANCE KNIFE MAKERS MANUAL

With the knife on the anvil, carefully peen the edges on the pin. Turn the knife over and repeat the process. Keep doing this until you have the pin peened very tight, and it has filled up the counter sink in the bolster.

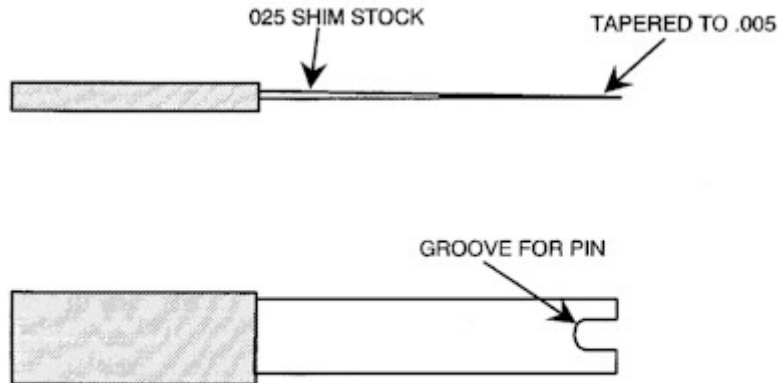

THE SLACKING TOOL FOR FITTING THE BLADE

Remove the slacking tool, and open the blade until it locks. Wiggle the blade sideways to see if there is any play. If there is, insert the slacking tool back in place and peen the pin more. This time peen the pin more on the top side (lock side) of the handle. I use the flat side of the ball peen hammer for this, and hit the pin one or two good smacks.

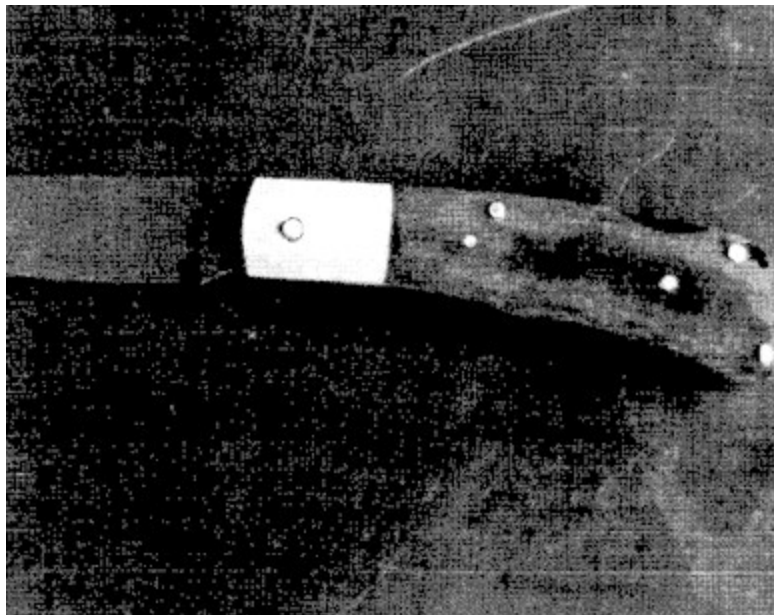

KNIFE READY FOR PEENING

Remove the slacking tool and open the knife all the way again to check for side play. When you feel the blade get tight about 3/4 of the way open you have it right. This is a self-tightening design of the knife, and will keep the blade tight through years of use.



## THE ADVANCE KNIFE MAKERS MANUAL

On a spring back, you do not tighten the blade this tight, as it needs the clearance to work satisfactory. When you close the knife up, it should snap shut with no binding, due to the clearance the slacking too gave it.

Now you can peen the center pin, if everything is working satisfactory. On the lock back, just peen it enough to fill the counter sink. Do not peen it to tight or the lock will be too tight to work freely. The spring back you do not have to worry about.

### FINAL FINISHING OF THE KNIFE

You now have the knife together, and it is working, as it should be. You can now finish the out side of the knife. Go to the Wilton, and put on the pivot arm (the one with the 1/2 roller on the bottom, and the 3 inch roller on the top). Start with the 180-grit belt, and clean up the out side of the handles.

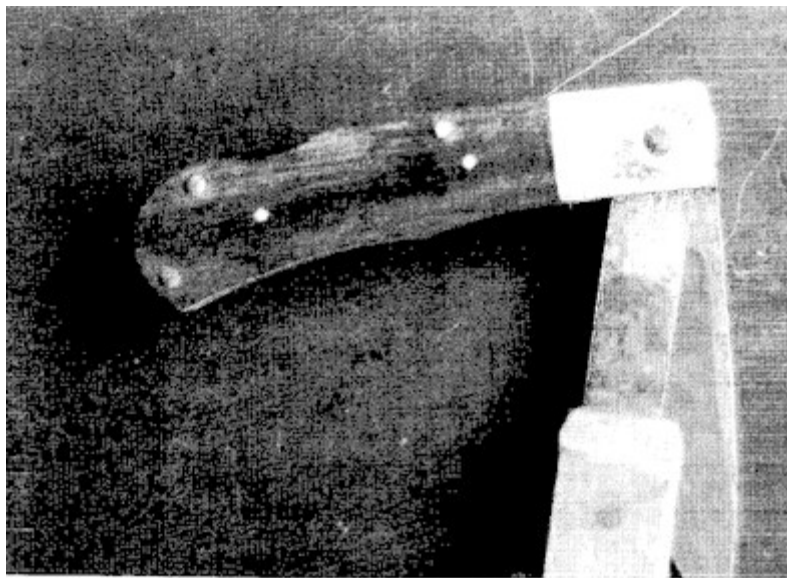

*FITTING BLADE IN HANDLE WITH SLACKING TOOL*

Remove the rivet, dents, etc. from the outside of the handle. If you are going to keep the knife flat, omit this process. We will cover this next. Put enough radius on the handle to give about 1/16 clearance on the edges from the liner. This bevel will make a more attractive knife.

## THE ADVANCE KNIFE MAKERS MANUAL

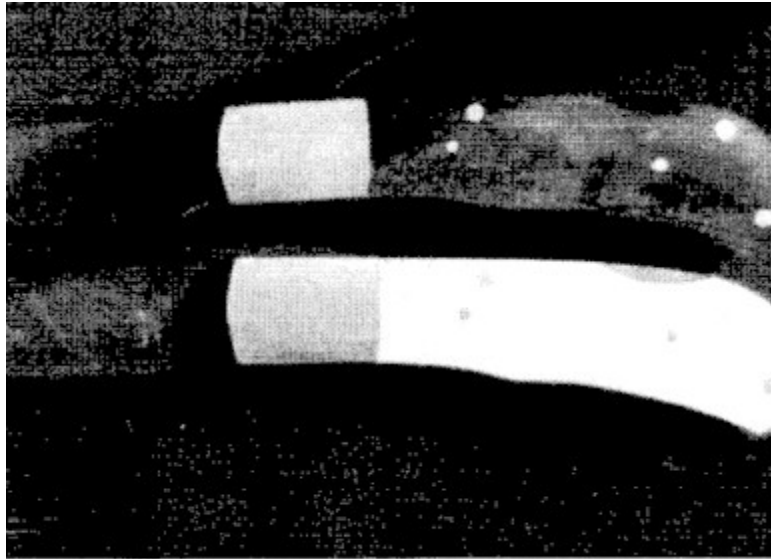

*OUTSIDE OF KNIFE FINISHED RADIUS WITH 180 GRIT*

When all the dents, nicks, are removed use a 240-grit belt to finish it a little smoother. You end up with a 320 grit belt to get the final finish before buffing (See Chapter On Buffing).

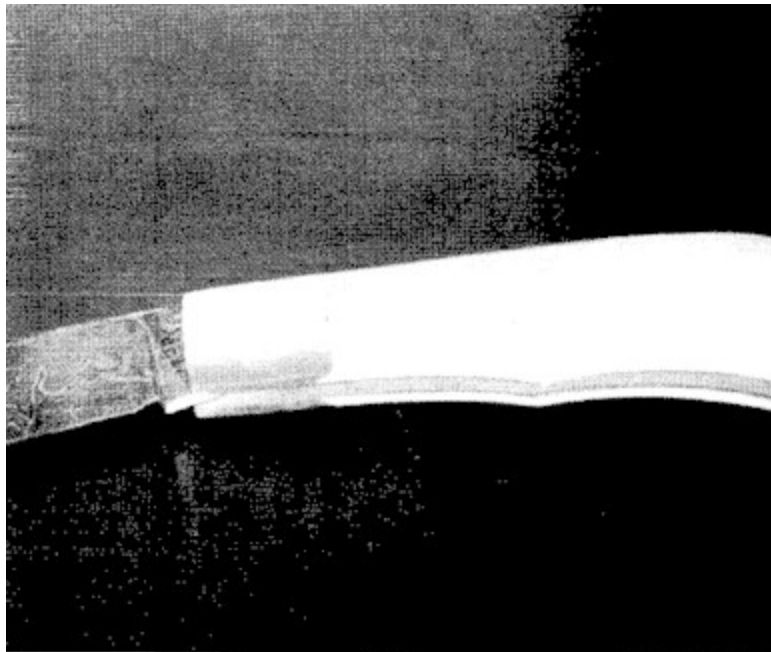

*KNIFE FINISHED WITH 320 GRIT*

### FLAT-SIDED KNIFE

On this type of knife all that is needed is go to the table sander, and flatten it out, and remove the dents with a 180-grit belt. Wholesale Tool has belts of all different grits; so once you have the handle flatten out, go to the finest belt to remove all the scratches.

## THE ADVANCE KNIFE MAKERS MANUAL

You will need to have a 1/16 inch flat all the way around the handle to break up the sharpness. This can be done by hand or on the belt sander.

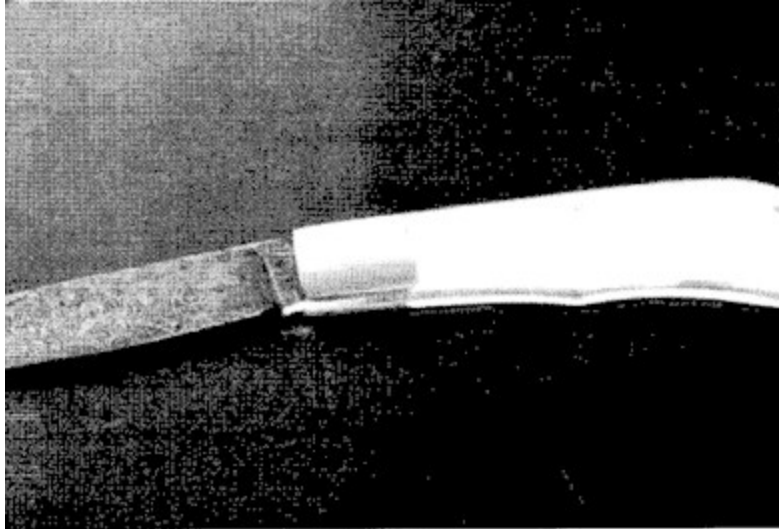

FINISHED KNIFE

The edge of the knife needs to be finished on the sander to even up, and make everything flush. Use a fine grit belt to do this. The lock, or spring may not be flush with the outside edges, and needs to be flushed so it will be flat.



## FINISHING

### WOOD FILLER

The best wood filler, in case you ever do need to fill a small space or two, is made from epoxy glue and the sawdust from the wood you are using. Take a piece of the wood and grind it with a new, fine grit belt, mix the dust half and half with mixed epoxy glue, and quickly press it into the crack.

No sealer is needed on antler, but if wood is used it should be sealed. I used an even mixture of linseed oil and varnish. The mix was liberally rubbed on with a cloth and allowed to soak into the wood for about half an hour. The excess was then wiped off, and the finish was allowed to dry overnight. This process was repeated four times. There are several commercial preparations that will also produce attractive and durable results.

### HAIRLINE CRACKS

If at any time you see a minute check in the wood that would be a structural weakness or even a minor eyesore, I use super glue that is so runny it is absorbed into the most minute crack or check.

The glue, sold under many names, dries as hard as epoxy glue and effectively removes small cracks and checks from the knife handle. It dries clear and the crack or check it absorbs into is invisible. Super Glue is the only modern adhesive I know of that has this particular absorbent characteristic.

Between the 90 and 120 grit sanding steps, I inspect all the edges of the handle, around the rivets or pins and any part that might contain the threat of a crack or check. Any suspicious mark gets a drop of Super Glue. Then, I just sand the glue residue flush during the 120-grit step. This glue works great to fill any minute cracks next to a bolster in a folding knife.

Continue sanding the handle in finer grit steps, polishing up to 240 or 320 grit. Buff the handle using the same stainless buffing compound that was used for the blade.

### FLAP SANDING THE HANDLE

A Flap Sander is a revolving metal drum with a series of abrasive cloth flaps that strike the work piece at high speed. Use it to sand the hollow areas of the handle. It imparts a very smooth finish to the handle, or with different types of abrasives it can produce different effects on the handle, such as driftwood or a raised grain effect. The flap sander action is very much like the action of a sand blaster and imparts a very attractive finish for a work knife.

# THE ADVANCE KNIFE MAKERS MANUAL

After buffing the handle, I clean it and let a heavy coat of a Danish oil or Tung Oil and let it soak into the wood, followed by a second coat in about a half hour. After this coat soaks in for half an hour, I wipe as much of the oil off as I can with a clean rag and let it dry overnight. This oil penetrates the surface of the wood and hardens, sealing it against moisture, which is very important for wood that does not have any natural oils.

## **BUFFING THE HANDLES**

The next step is to buff the handles to finish the knife. Use about 500 or finer grit for finishing the knife. Close the blade in the handle, and polish the bolster first on the front side of the bolster. You buff the bolster up to, but not where the handle material butts the bolster.

When you get all the scratches out turn over the knife and do the other side. DO NOT

**BUFF TO THE TOP EDGE OF THE HANDLE AS IT MAY GRAB AND JERK THE KNIFE FROM YOUR HANDS.** Always buff from the center to the lower edge.

Now polish the back part of the bolster down toward the handle. This will help keep the handle from dishing out where it joins the bolster. Polish this area only enough to get it scratch free, and no more. Finish polishing the rest of the handle and around the out side of the knife.

## **SHARPENING THE BLADE**

I usually do this on the belt sander to get the main edge and angle. From there I go to the grinder that has the cardboard wheels on it.

It takes about 1 1/2 minutes to sharpen a knife this way to get a shaving edge on it. Just remember that sharpening the blade is the last operation, except oiling the knife.

When the blade or blades are sharpened, blow out the knife, remove any buffing compound. Then oil the blade, spring or lock, the hinge area, and the outside of the knife. Work it a few times and you are done.

## **FILED BACKS**

Filing the Backs and adding exotic handle material for the handles will add greatly to the beauty of a knife. The four items needed for filing the backs are 2 files (a round file and a small three sided file) time, and patience.

Place the back spring or blade in the vise (this has to be done before heat treating). Paint the top with steel dye and mark off lines about apart. With your round file, file a 45~ angle to the side of every other line. Now do the same on the other side. After this is done, uses the three

## THE ADVANCE KNIFE MAKERS MANUAL

sided file and strike a line between every other notch. This will give you a good standard pattern. The inside of the springs can also be worked. Be careful and not work the area where the kick will strike for this may lower the blade.

## BUFFING AND POLISHING

### POLISHING AND BUFFING WHEELS

Polishing wheels in general use are constructed of muslin, canvas, felt, and leather. By changes in construction, offer to the operator wheels of varying flexibility that best suit the particular object to be finished and the condition of its surface.

Polishing wheels in widest use are made of woven cotton fabrics, the hardest wheel of this type being made of individual discs of canvas cemented together. The softest being composed of discs of muslin sewn together between these extremes is the most popular wheels are composed of sewed sections of muslin discs fastened together by adhesives.

For economy, these sewed sections are often made of balanced pieces of muslin rather than full discs of cloth. As a class, cotton fabric wheels, because of their versatility and their relatively moderate cost, are the most commonly used medium for general all-around polishing.

Pressed felt wheels, available in densities from rock hard to extra soft, are indicated where the face of the wheel must be kept true and be absolutely uniform in density over its entire surface. The face of a felt wheel can be easily contoured to fit irregularly shaped articles. Because of their higher initial cost, they are generally restricted to the finer abrasive grit sizes.

Solid leather wheels of walrus and bull neck leather are tough but resilient, with a springy open grain, and are favored for the fine polishing required in cutlery and gun work. Wood wheels covered with leather belting are popular for flat surfaces where a minimum of flexibility is desired. Wheels made of sheepskin discs are used where great flexibility and less density are needed. In the harder sheepskin wheels, the individual discs are cemented together while in the softer types the discs are held together only by hand sewing.

Practically all the materials mentioned above which are used in disc form for the production of polishing wheels can be used in a different manner in the production of the so-called compress wheel. In this wheel, small pieces of leather or woven fabric are placed in a rigid center section so their edges are perpendicular to the side of the wheel. Accordingly, there are no seams following the direction of rotation and more precise polishing can be done than with any other type of a built-up wheel.

Various grades of flexibility are available for each type of material used and, with the stiffer density woven fabric compress wheel in particular. A degree of fine polishing can be obtained that cannot be duplicated with wheels of different construction.

# THE ADVANCE KNIFE MAKERS MANUAL

## NITRIC ACID STRIPPING.

If the part you are going to buff has been plated, you will need to deplate it. The following is two methods that I have used.

A method that I have used to strip nickel-plating is to immerse the desired parts in a glass container that is filled with Nitric acid. When using this chemical make sure that the parts are completely covered by acid, take extra care that the bore and chambers are plugged. Since this solution will dissolve a 0.001" thick nickel plate in 15 to 20 minutes, you must watch the stripping operation constantly and remove the parts as soon as they are stripped. When the parts are taken from the fuming nitric acid they must be dipped into a chromic acid solution for a minute and then very thoroughly rinsed in water. Do not put the part when you remove it from the Nitric Acid directly into water, as the water will cause the nitric acid adhering to the surface to etch the steel.

Like hydrochloric acid, nitric acid gives off fumes that settle on and rust everything within several feet of the container. Nitric acid should be stored, poured, and used either outdoors or in an unused room where there is nothing that will rust.

## RAPID METAL REMOVAL

A need for rapid metal removal or where there are no contours and a flat surface is to be maintained. Conversely, the softer types of polishing wheels are used where there are irregularities in the surface and the fast removal of metal is not the prime requisite.

To remove pits, scratches and scale, and put a high finish on the surface of a barrel, receiver, part, or tool, various wheels must be used. For practical purposes the main wheels that the gunsmith needs are:

2 canvas wheels	8" dia. X 1" wide
2 " "	8" dia. X 1/2" wide
2 " "	6" dia. X 1/2" wide
1 felt wheel	6" dia. X 1" wide
2 cloth buffs (sewed)	10" dia. X 3/8" wide or 1/2" wide
21 "	10" dia. X 2" wide
2 (Loose muslin)	10" dia. X 2" wide

# THE ADVANCE KNIFE MAKERS MANUAL

## ADHESIVES:

Most widely accepted adhesives for fastening of abrasive grains to the surface of a polishing wheel are manufactured adhesives or cement compounds. They are replacing hide glues which, up to several years ago, were considered the ideal adhesives for preparing polishing wheels in all grit sizes. Polishing wheel cements are now formulated to give a wide range of viscosity's and flexibility, and can be used with a wide range of abrasives and grit sizes.

If hide glue is to be used, it should be a high-grade material selected for jelly strength, melting point, viscosity, and flexibility.

It should be free from excess bacteria content, which will decrease its strength. Melted glue should be made up only for the days needs and not in advance, to minimize the bacteria that will be picked up from the air.

Overheating and prolonged heating, even at low temperatures, quickly loses glue strength. It is advisable to have the glue pot thermostatically controlled to minimize the time that the glue is kept in the melted condition. At the end of the day the glue pot and brush should be sterilized so bacteria are not carried over to contaminate the next day's batch.

The correct proportion of glue and water will vary with the strength of the dry glue and the size of the abrasive particles to be held. When the type of hide glue has been selected from a reputable supplier, exact proportions of glue and water should be decided upon for the size abrasive to be used. This proportion rigidly adhered to measuring the glue and water by weight rather than by guesswork.

The following condensed table gives approximate proportion, which will help in determining the final figures after the brand of glue has been selected.

When glue stirring is required, a preliminary coat should be applied by a bristle brush and allowed to dry before putting on the coating that is to hold the abrasive. New wheels should be rinsed on both the face and sides.

To prevent chilling the glue, the wheel and the abrasive should first be heated to approximately 1200° Fahrenheit. The coating for the first head should then be brushed on and the wheel immediately rolled in a trough of the proper abrasive.

After allowing to air dry well for one to two hours, the second coating if required is applied in a similar manner. In order not to contaminate the wheels with wild abrasive grains, separate brushes and separate glue pots should be provided for each size abrasive.

After the final coatings, the wheels are dried in a well-ventilated room at about 200° Fahrenheit, with a relative humidity of about 50%.

## THE ADVANCE KNIFE MAKERS MANUAL

Wheels should be dried for 24 hours for each abrasive head applied.

After drying, the wheel is balanced and the surface broken up to provide resilience and free cutting by hitting with a round bar diagonally across the face of the wheel.

# THE ADVANCE KNIFE MAKERS MANUAL

## GRIT SIZES

GRIT SIZE OF ABRASIVE	% by weight Dry Glue
#30	50
#36	45
#46	40
#0	35
#80	33
#100	30
#150	25
#220	20

To prepare used polishing wheels for recoating; an abrasive stick is often used for reviving the old heads, which leaves the wheel trued up properly for reheading. Although the glue and abrasive can be removed by rotating the wheel on a pair of wet rolls, this method should be restricted to those wheels that will not be harmed by water soaking. If a polishing wheel lubricant is used, this grease must be removed before reheading and it is necessary in some cases to use organic solvents to effect this removal.

Proprietary manufactured adhesives and cements, which have made great inroads in recent years into the field once held exclusively by polishing wheel glues, offer many distinct advantages. They can be used at ordinary room temperature, as received from the manufacturer, thus eliminating special equipment, precautions, and preparations required for efficient use of hide glues.

## LEA POLISHING COMPOUND

Some of the compositions used with these wheels are abrasive powders, Lea Polishing Compound, and, glue to bind the abrasive powder.

All polishing wheels, no matter what method of setup is used on them, should be broken up. This is done by striking a blow to the face of the wheel with a round bar at a 45" angle to the



## THE ADVANCE KNIFE MAKERS MANUAL

side of the wheel. By striking a blow every 1/2" completely around the periphery at this angle, and then by striking another blow every inch at 90 degrees to the first blow, a diamond pattern will be formed, which is the ideal pattern for good polishing.

Breaking up of a polishing wheel, after it has dried and just prior to its use, also serves to localize any tendency the bonded abrasive might have to rip off if a sharp corner of the piece being worked is thrust against it too quickly.

The cake lime, which comes molded in containers, is excellent for putting a high polish on rubber butt plates, fore-end caps, plastics, and non-ferrous metals.

Emery paste is used as a lubricant and cutting agent on wheels coated with abrasive. Emery paste comes in a molded paper container and is made in grit sizes from 90 to 180 inclusive.

Lea Compound, is one of the finest compounds that I have used. It is a greaseless composition that comes in a round solid bar about 10" long and 2" in diameter, and enclosed in a hermetically sealed metal foil container. In addition, although it comes in various grits and grades, the grade "C" (200 grit) is best for all around polishing on guns and gun parts.

Where applied to a revolving wheel, the frictional heat causes the compound to melt at the point of contact with the wheel and to transfer. It immediately sets up and dries on the wheel, forming a dry, grease-free, abrasive-coated wheel. After a gun has been Lea-buffed, it need not be cleaned with a solvent, for Lea does not leave a greasy film on the metal surface. Another advantage of Lea Compound is the ease with which it cuts. With Lea, it is not necessary to apply much pressure to the work on the wheel. The artificial abrasives in it have sharp, fast cutting qualities and little or no lubrication to drag against the work.

Lea Compound can be used directly after the part to be blued has been deoxidized or, if deep pits are present, after they have been ground out by a canvas abrasive wheel. After the gunsmith has used Lea Compound, a few times he will no doubt appreciate what a useful addition it is to his polishing equipment.

In addition to its usefulness for pre-bluing work, it also does well as a deburring abrasive on small parts and springs that resist filing.

### **FOR MORE INFORMATION ON LEA COMPOUND CONTACT-**

Lea Mfg.  
237 E Aurora St.  
Waterburym, CT. 06720

The directions that come with Lea Compound must be followed to the letter, for when exposed to air it hardens to the point where it "ill not flow onto the buffing wheel. Here are the directions for using Lea Compound as recommended by the manufacturer:

# THE ADVANCE KNIFE MAKERS MANUAL

## USING LEA COMPOUND

1. Use a knife to cut the container close to the tapered end.
2. Remove the end.
3. Tear away a narrow strip of the container, exposing about 1/2" of Compound.
4. Do not remove entire container.
5. Hold the Compound against the revolving wheel until a uniform coating is produced.
6. Allow to dry a few seconds, after which polishing may be commenced.
7. Use mild pressure of gun parts against the wheel while polishing.
8. Place Humid cap over exposed end of the tube immediately after using. Never leave the Compound exposed to the air, as it will become dry and hard.
9. On hot days place sealed bars in cold water for a few minutes before using.
10. In addition, store unopened bars of Compound in a cool place to prevent softening and deterioration.

Cement bonded wheels will withstand higher temperatures both in drying and use, can be dried more rapidly, and withstand the great frictional heat caused by high polishing speeds. Although most cements are formulated for fast, tough, coarse polishing, they have been used successfully for fine polishing.

More recently cements are being formulated which have some of the desired flexibility found in hide glues. As such cements and adhesives are, in the main, proprietary mixtures, it is best to follow the manufactures recommendation in each case rather than attempt to set general rules to cover all if them.

## ABRASIVES:

The abrasive most widely used in polishing metals is fused aluminum oxide. The grain is normally heat treated to give it good capillarity and in addition many types are etched or coated to improve the adhesion to the bond used. Fused aluminum oxide is sharp, hard, fast cutting and long wearing.

Another abrasive used is silicon carbide, which fractures when dull to present new sharp

## THE ADVANCE KNIFE MAKERS MANUAL

cutting edges, and for this reason is selected in certain specialized operations. Silicon carbide grain, however, is more difficult to bond firmly to the wheel; its scope is limited. Before the advent of the electric furnace abrasives, Turkish emery, a natural compound of the iron oxides, was the standard polishing grain. The edges of Turkish emery tend to wear smooth without fracturing, and although this property decreases the spread of cut.

It is sometimes desirable for fine polishing operations, particularly in the cutlery field.

### **LUBRICATION:**

Lubrication of the cutting face of a polishing wheel, with oil or grease, is desirable in a number of cases to prevent gouging when a fine polished surface is required. It is also used to minimize frictional heat when polishing some of the softer metals, particularly aluminum. The most popular method of lubricating is by a tallow grease mixture applied by friction from a bar to the rotating polishing wheel.

Special bar lubricants are now available, which have the unique feature of freeing abraded metals, particularly the softer nonferrous type, and prevent them from loading at the face of the polishing wheel. Where polishing wheels can be lubricated automatically, spray-able liquid lubricants are now available in formulations, which are easier to clean.

### **SPEEDS:**

Speeds for the efficient operation of polishing wheels generally fall between the limits of 6,000 to 8,000 surface feet per minute when glue is the adhesive used. At higher speeds, because of overheating, the glue tends to break down although polishing wheels set up with cement can safely withstand this heat up to 9,000 surface feet per minute.

With too low a speed, the abrading operation is slowed down and, in addition, there is a tendency for the abrasive to be ripped out of the wheel. On certain metals susceptible to physical changes because of overheating, the ability of the adhesive to withstand heat is not the limiting factor but rather the heat tolerance of the metal.

### **POST WHEELS AND FLEXIBLE POLISHING:**

In the polishing coatings, described above, dry abrasive grain is fastened onto the coating of adhesive covering the polishing medium. Although the adhesive covers the lower part of the individual abrasive particle to grip it properly, a large proportion of the area of this abrasive grain is exposed free and uncoated.

## THE ADVANCE KNIFE MAKERS MANUAL

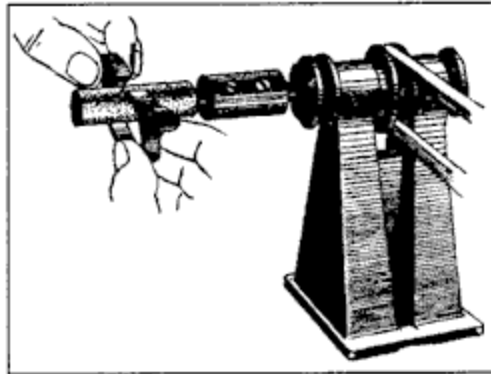

**POLISHING TRIGGER  
GUARDS**

This open feature on the polishing face is highly desirable in many instances, particularly where fast cutting is desirable. However, in a number of fine polishing operations, it is more desirable to have a closed surface that is obtained by having intimate mixtures of the abrasive grain and the adhesive.

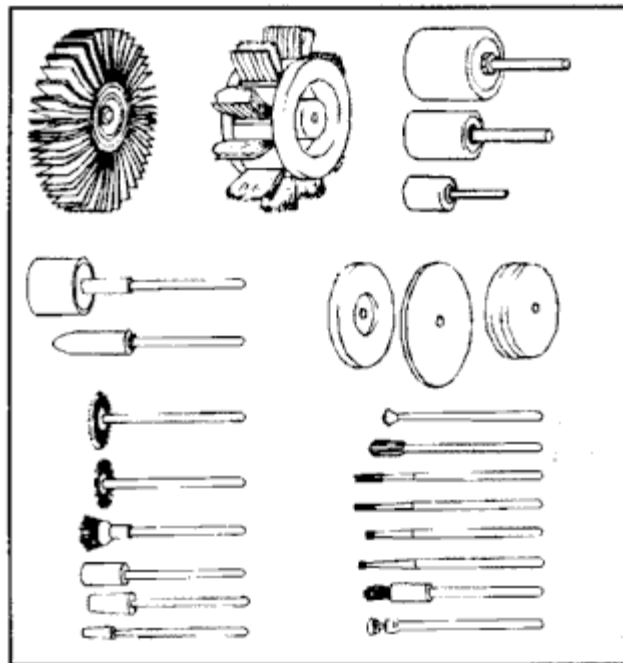

**DIFFERENT TYPES OF  
POLISHING BUFFS**

Paste wheels, where the melted glue is thoroughly mixed with abrasive and the mixture then troweled onto the face of the polishing wheel in multiple coatings. These have long been used in the cutlery industry particularly for double header polishing on steel knife blades. Silicate cements have also been mixed with abrasives for similar purposes. Special techniques have been developed so wheels of this type can be built up by frictional transfer of greaseless compound applied to the polishing wheel as it revolves on the spindle of the

# THE ADVANCE KNIFE MAKERS MANUAL

polishing arbor.

## APPLYING THE ABRASIVE

Flexible polishing wheels of this type are headed up by the following procedure:

A glue-base sizing material in bar form is brought to the revolving wheel, pressure is applied, and the power is shut off. During deceleration the sizing coat is melted and flowed onto the surface of the wheel. The motor is then turned on and off to start drying at less than full speed. It is finally run at full speed for about two minutes or until the sizing coat is no longer sticky to the touch.

The bar of greaseless compound, also glue-base, is applied in the same manner with pressure when the power is shut off. During deceleration the heavy coating of greaseless compound is melted and transferred to the wheel with sufficient frictional heat, so the layer of greaseless compound is firmly bonded to the sizing coat.

This coating is dried in the same manner as mentioned for the sizing coat and for approximately the same time.

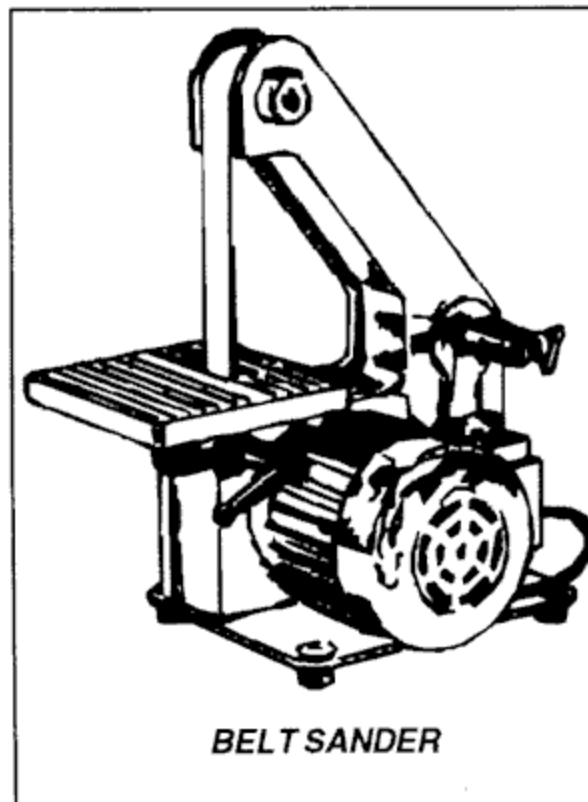

## THE ADVANCE KNIFE MAKERS MANUAL

A second coating of greaseless compound can be applied in like manner without additional sizing and in this manner, heads can be built up to 3/16" in thickness. In the formation of flexible polishing wheels of this type, it is essential that the stop and start technique be followed closely.

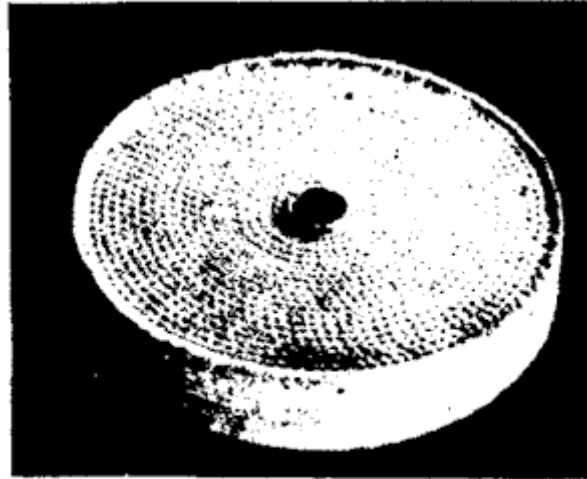

**POLISHING WHEELS**

If the lathe were allowed to run at full speed and the compound applied at the necessary pressure, centrifugal force would throw most of the material off. During deceleration, however, the greaseless compound is flowed evenly onto the face of the wheel. With this procedure, true polishing wheels #80 grit and finer can be produced and reproduced, ready for use in less than ten minutes without the necessity of ever removing the wheel from the spindle.

By selecting the cloth polishing wheel of proper resiliency, flexible polishing wheels can be made up with greaseless compound that have many advantages over broken-down conventional polishing wheels which have long been used for certain fine polishing operations.

### **TYPES OF WHEELS TO USE**

For removing pits-

Felt wheels or stitched buffs

For over-all polishing-

Loose muslin buffs

### **SIZE OF WHEELS TO USE**

6" diameter at 3,450 r.p.m.

# THE ADVANCE KNIFE MAKERS MANUAL

10" diameter at 1,750 r.p.m.

These wheels can be produced in the proper surface condition when wanted, rather than wait for preliminary polishing operations to break down the abrasive surface into the desired state. The technique in producing a flexible polishing wheel with greaseless compound is such that much softer cloth wheels can be employed than can be used by the conventional polishing wheel setup procedure.

Such wheels can call upon the resiliency of the cloth to cushion the cutting action of the abrasive grain, whereas with the conventional polishing wheel this effect can only be obtained by the use of excessive lubrication.

Advanced alkaline cleaning recommendations call for two complete cleaning cycles each with rinses and acid dips when greased wheels are used. One complete cleaning cycle is safely bring eliminated in many shops when flexible polishing with greaseless compound is substituted for the final grease conventional polishing wheel procedure. Flexible polishing wheels operate most efficiently at 5,000 to 6,000 surface feet per minute.

## **BUFFING**

Buffing, as the operation following polishing, can be divided into four operations, each of which can be an end in itself depending upon the finish required. These are Satin Finishing for producing satin, brushed or butler finishes, Cut down Buffing for producing a preliminary smoothness, Cut and Color buffing for producing an intermediate luster; and Color buffing for the production of a high gloss or mirror finish.

## **GRINDING AND POLISHING EQUIPMENT**

To achieve a good finish on metal, certain basic equipment and skill is necessary. Without the proper equipment, it is almost impossible to acquire the necessary skill, for skill comes from constant practice of the right kind with a good polishing head or polishing lathe and suitable wheels and polishing compounds.

## **POLISHING HEAD**

A good polishing head can either be made or bought. In either case, it must meet certain basic specifications. In the first place, the shaft should be at least 1/2" in diameter and threaded for a length of 2 1/2" at each end. The shaft should be set in a heavy iron or steel unit equipped with roller bearings. Tapered roller bearings are the most economical and efficient, for a buffing motor.

The motor should be at least one-half horsepower and equipped with a two-place step cone pulley to match a similar pulley affixed to the shaft. The pulley should be placed in such a way as to achieve a 1 to 1 and 2 to 1 ratio, thus giving a shaft speed of approximately 1,750 and

## THE ADVANCE KNIFE MAKERS MANUAL

3,500 r.p.m. When turned by a motor having a speed of 1,750 r.p.m. The low speed is for grinding operations and the high speed for buffing and polishing work. This provides an all-purpose setup suitable for all phases of gun work.

The shaft unit and motor must be bolted to a very sturdy and heavy stand, which in turn should be bolted to the floor. The height of the polishing head is important, which will have to be determined by the gunsmith, as all are the same height, nor do all choose to work at the same level. Generally ideal height, however, is when the shaft is at the same level as the operator's waistline.

A good arrangement for the motor switch is one so wired that it can be controlled either by hand or foot. This is especially handy when polishing rifle or shotgun barrels that require two hands to hold. In an emergency, the foot can be actuated to shut off the motor.

Metal guards placed around the ends of the shaft where the wheel rotates, and hooked up to a suction blower arrangement. Exhaust blowers are good, because they prevent the abrasive and lint of the wheel from settling on tools and machines in the shop.

### USING POLISHING WHEELS

The most important thing to remember when working with abrasive dressed wheels is that these wheels cut, and in cutting remove metal. Unlike hard-stone grinding wheels, the soft-back dressed wheels do not give off a great volume of sparks, which often fools the polisher into believing that practically no metal is being removed. Many a novice has almost ruin his first few guns to be blued by grinding hollows into the surface of a barrel thinking that there was metal being removed.



## PRACTICING ON AN OLD KNIFE

If you do have an old knife, the beginner can practice on a steel bar. The bar is a piece of flat cold rolled steel about 4" long, 2" wide and 1" thick and using various sizes and grits of dressed canvas wheels to grind the pieces. The same sort of exercise can be carried out on round, square, and octagon-shaped pieces until the beginner has gotten the feel of the wheels, so to speak.

When the knife maker knows how each type canvas, felt, cloth, etc. of wheel will cut when dressed with any of the various abrasives, in different grades. He has pretty well mastered the basics of grinding or polishing, if you are using the very fine compounds with so-called dressed wheel.

## CORRECT GRIT

Using too coarse a wheel to grind pits from a surface is poor practice because deep scratches are made which must in turn be obliterated by successively using finer grit wheels. On the other hand, using too fine a wheel makes for a slow job in which the metal gets very hot and breaks down the glue, which tends to clog the normal space between the abrasive grains.

The gunsmith should remember to always use the widest wheel possible for the job being done. With a wide wheel, the chances of waves on a flat surface are greatly minimized and the job can be done faster.

Unless a barrel is badly pitted there is really no need to use anything except a muslin buff dressed with a fine grit abrasive. If the barrel is not pitted at all and there are no deep scratches or tool marks in it that must be removed. A buffing wheel headed with Lea compound will cut away all the metal that is necessary to produce a surface ready for high speed buffing.

While barrels can be ground lengthwise on a formed wheel, made by cutting a concave radius in a canvas wheel in the lathe, and then dressing it. I do not believe lengthwise grinding is necessary on anything but a set of double barrels or a single barrel that has a full-length rib on it.

Standard single barrels can be ground and polished around their periphery, and then given a high speed buffing in any direction that will eliminate the cross grain grinding marks.

Satin finishing operations are performed by greaseless compounds combining fast-cutting abrasives with a glue base binder. Numerous grades are available, employing abrasive from #50 and finer, for varying degrees of dullness of finish on all base metals and electro deposits. In the most popular all-around grades, artificial aluminum oxide and silicon carbide abrasives are used in grit sizes from #180 to #220. Silicon carbide grades are widely used

## THE ADVANCE KNIFE MAKERS MANUAL

for finishing aluminum and stainless steel and the aluminum oxide grades are favored for brass and other nonferrous metals, as well as for carbon steel prior to plating. For finer effects on brass and electro deposits, finer sizes of American emery and hard silica are employed.

For butler finishes on silver plate and sterling, fine buffing powders of unfused aluminum oxide and soft silica are used.

Bright butler finishes that challenge the luster produced by grease base coloring bars can be obtained on silver by extremely fine greaseless compositions made with a specially lubricated binder.

### GREASELESS COMPOUNDS

Greaseless compounds are used at speeds of between 5,000 and 6,000 surface feet per minute. Higher speeds waste the composition without a proportionate increase in production rate. Greaseless compositions do not penetrate the buff as does grease base compositions but lie on the surface, which favors buff life.

The buff should be allowed to run for 20 to 30 seconds after greaseless compound has been applied before the work is brought to the wheel, so there will be no back-transfer of compound. When used correctly the work will leave the greaseless compound wheel clean, dry and in proper condition for inspection and finishing.

Certain metals, such as aluminum, are susceptible to dragging by dry abrading, but a light tip dressing of a low free-grease content buffing bar will sufficiently lubricate the surface and produce an even finish. In this case, care should be used so the lubricant does not penetrate the layer of greaseless compound and saturate the cloth, which will prevent the proper adhesion of subsequent additions of greaseless compound.

Binders for grease base buffing compositions are composed of fats and waxes of animal, vegetable, and mineral origin. Some of the more commonly used are stearic acid, hydrogenated fatty acids, tallow, hydrogenated glyceride, and petrolatum.

The fatty acids under conditions of buffing seem to have, in addition to their physical properties, a beneficial chemical effect in the formation of metallic stearates.

Cut-down buffing bars combine fast cutting buffing powders in a grease base binder formulated to give a great amount of grip to drag between the wheel and the metal surface. Powder to binder proportions varies with the type of work, the condition under which it must be done, and the oil absorption of the buffing powder.

Careful study of the individual buffing operation is necessary to decide on formulation. The metal being buffed in a cut-down operation determines which buffing powder to use. Cut down compositions for non-ferrous metals most frequently contain once ground Tripoli. It

## THE ADVANCE KNIFE MAKERS MANUAL

Performs very efficiently and is relatively inexpensive.

Cut-down buffing bars for carbon and stainless steels are generally based upon fused and unfused aluminum oxide. Such compositions are sometimes recommended for use on some of the aluminum alloys, particularly parts made by casting or extrusion. Under certain conditions, a cut-and-color buffing operation is used in place of the cut-down and the highest coloring operations. Since fast cut is not a prime requisite, the cut-and-color compound binder is of the same general type as above, but with less drag.

Moderately cutting abrasive powders are selected to give some brilliance with moderate cut, thus sacrificing both cutting and coloring properties to produce a general-purpose composition.

Cut-and-color compositions for nonferrous metals contain white silica powders, or a blend of these powders with Tripoli. Similar compositions for the ferrous metals contain coarse unfused aluminum oxide powders or a combination of fused and unfused aluminum oxide powders.

On certain nonferrous articles, cut-and-color buffing is done with a crocus bar containing a coarse graded iron oxide powder. Producing a color, luster, or mirror finish on metals requires the use of compositions composed of the finest abrasive powders so a minimum of scratches will show in the final finish.

Fast cutting is not required in such operations, and binders are formulated primarily to hold the selected abrasive powder to the wheel, allowing it to color or burnish out the scratch marks left by previous buffing operations.

Bars containing powdered lime as the abrasive are used for coloring nickel plate and, in some cases, for coloring brass. Compositions with fine unfused aluminum oxide powders are used in coloring stainless steel, nickel and chromium plate, and sometimes brass and aluminum.

However, brass and aluminum are generally colored with bars containing soft white silica powders in the finer sizes positions composed of the finest abrasive powders so a minimum of scratches will show in the final finish.

Fast cutting is not required in such operations, and binders are formulated primarily to hold the selected abrasive powder to the wheel, allowing it to color or burnish out the scratch marks left by previous buffing operations. Bars containing powdered lime as the abrasive are used for coloring nickel plate and, in some cases, for coloring brass.

Compositions with fine unfused aluminum oxide powders are used in coloring stainless steel, nickel and chromium plate, and sometimes brass and aluminum. However, brass and aluminum are generally colored with bars containing soft white silica powder in the finer sizes.

## THE ADVANCE KNIFE MAKERS MANUAL

Fine chromium oxide powder is used in compositions for coloring stainless steel and chromium. Rouge compositions, containing the finest red iron oxide powders, are widely used in coloring gold and silver.

The fine red oxide powder has unique burnishing qualities to bring out the required high luster on the soft precious metals. Although the speeds for buffing with grease-bars will vary greatly from job-to-job and operator-to-operator, the following figures in surface feet per minute will serve as a starting point for hand buffing operations.

Buffing speeds may vary, as the contact of the work to the wheel can be more definitely fixed without depending upon the physical ability of the hand buffer to maintain the proper position and pressure.

# THE ADVANCE KNIFE MAKERS MANUAL

## FORGE SETUP

This is just the basic information on forging. Knife making after the Stone and Bronze Age all started with forging of steel to make swords and knives. In this chapter, I want to cover a little of the process of forging steel and making Damascus knives. I am not that experience on blacksmithing, but I am familiar with it as my Dad had his own forge setup on the farm when I was young. I talked to many Blacksmiths in our area, they supplied me with the information that follows, and I owe my thanks to their free information.

Blacksmithing is the art and science of shaping iron or steel while at red heat. This chapter will describe the use and control of the hammer, forge, and anvil, and will show the beginner how he can get started without making a big investment. For further and more detailed information, consult your local Blacksmiths in your area.

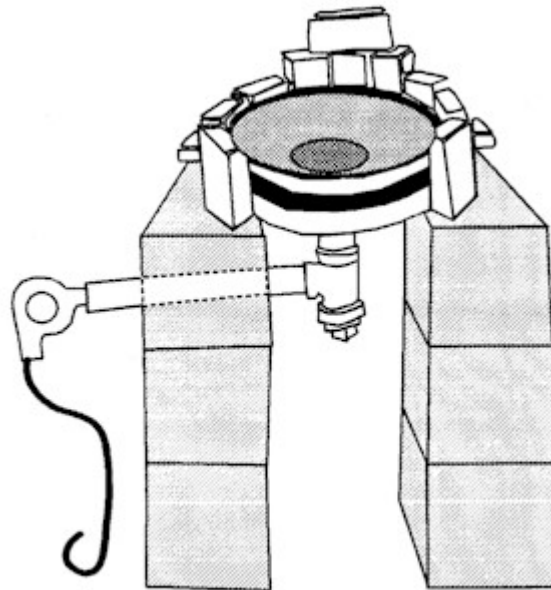

TIRE RIM FORGE

## THE FIRE

There are many types of hearth shapes and fuels that are being used for blacksmithing. The type used most, is often a cast iron bowl called a fire pot with legs mounted to it, and the main ingredient for heating is a source of driven air. A hand cranked impelled blower is not common nowadays, now they usually use a small blower driven by a variable speed electric motor. This motor is fitted with a rheostat to control how much air we are feeding to the fire. If you can find a forge with a hand crank, the speed and use of the crank will determine the heat of the fire.

## THE ADVANCE KNIFE MAKERS MANUAL

Some smiths prefer a hand crank, while others use an electric motor, so you should make the choice on the type you want.

If you are serious about blacksmithing, find a blacksmith supplier for a source of tools and buy the right equipment for the job. Centaur Forge Ltd., is one of the best sources for equipment, but in rural areas many small forges come up for sale at farm and ranch auctions, as well scrap iron buyers.

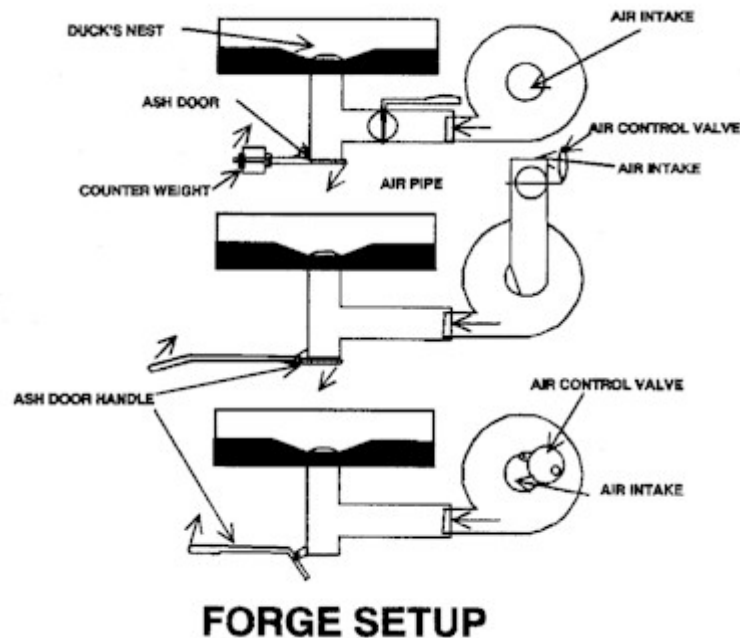

I will show you how to make an inexpensive forge how to use it. The forge is used on a solid surface, near a source of electricity and away from combustible surfaces. You can use it indoors, but because of the large amount of smoke that they produce; you will need some type of vent. There will be many hot sparks thrown off during forging, especially in the making of Damascus steel, so the floor must be concrete. If you are using a wooden floor, you need to sweep up any smoldering bits of steel to prevent the risk of a fire.

There are many ways to make a fire pot, I have seen many using a truck tire rim, and these can be found at a junkyard or local garage. In the forges, that I have seen it is set this up between two pillars made of three cinder blocks.

### TUYERE

The tuyere is the blow pipe through which a blast of air enters the forge. Most consist of 2 inch steel plumbing pipes, with a vertical pipe that slides up through the rim hole and is held in place by screws or a flange. You must set this pipe into position before they line the pot.

Usually, they make the lining of the pot with fireplace mortar, which we can purchase from a

## THE ADVANCE KNIFE MAKERS MANUAL

brickyard. The refractory cements can be purchased from Centaur Forge, or you might find it at a fireplace business. You can use pieces of firebrick to plug the holes in the rim and take up some volume, so you use less cement. Small stones or pieces of paving brick will also work. They laid these into position and the cement was pressed over them.

The drying of the cement might take several days in a damp climate. Do not lay the cement down in one thick layer, as cracking it is likely as it dries. To avoid cracking, build up the cement in layers over the course of a week.

We dampen each layer before the applying the next. If you do have cracks, the cracks soon fill with ash and do not diminish the heat of the forge.

The source of forced air in this forge is a motor from a vacuum or shop vacuum cleaner. I try to keep the heat of the forge from it, and use a 2-foot length of flexible dryer hose. You should install an adjustable rheostat in the line to the blower, as even at its low speed, it will be too fast for the forge. It would cause the fire to burn hot and use coal too quickly.

The pipe setup below the fire pot allows for the dumping of ashes and clinkers, which is the unburned residue of coal. A heavy screen or a couple short sections of steel rod are set across the opening will prevent the live coals from falling through the tuyere. Since the air keeps the fire directed upward by the force of its blast, we shield the screen from intense heat and will survive many uses of the forge before they need to be replaced.

### FUEL

The best fuel for a blacksmiths forge is coal, and the blacksmithing is best done with bituminous coal, a grade that is not as hard as anthracite. You can probably find a local blacksmith to sell you an appropriate amount of coal, or can probably recommend where to find it.

### TOOLS

The main tool of a blacksmith shop is the anvil. The anvil should be heavy enough to remain solid under use. A 150-pound anvil is a popular size, and they should mount it at a proper height and should be close enough to the forge to make it handy.

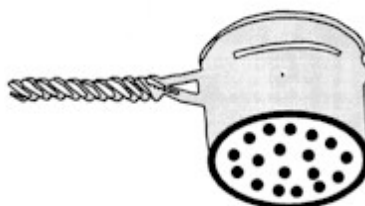

WATER CAN FOR FORGE

## THE ADVANCE KNIFE MAKERS MANUAL

A section of a railroad rail will make a workable anvil, and can be found at a scrap iron yard or foundry. We should mount it solidly, if the anvil is jumping away from you at each blow you will hold back on the hammering. Rig up a short sturdy table and bolt the rail into place.

You will need a good hammer that is heavy enough to work for you but not too heavy to be hard to use. It must be comfortable in your hand, have a flat face and a cross peen.

To set the work piece into the fire and, then hold it while we are forging it, you will need a pair of tongs. A fully equipped blacksmith shop might have as many as a hundred pairs of tongs, all made in different shapes. A pair with a flat grip will get you started and you can make more as you go. They can purchase tongs from a blacksmithing supply company and are sometimes available at iron scrap yards. A good size is 18 inches long, and most knife smiths with the relatively small work that they do can use a tong made to be lightweight.

Fireplace shovels and a garden trowel will come in handy, some type of metal scrub bucket, and a perforated tin can on a handle is also needed with a stiff steel brush.

### USING THE FORGE

Lay out all the materials before starting, they must be in a convenient workspace and well within reach of the anvil. You will need a bucket of coal, which is about ten to fifteen pounds per each work session. Have a cross peen hammer a coarse wire brush for removing scale. A vise and a pair of vise grips, a bucket of water, newspaper for starting the forge and matches.

Clothing should include heavy shoes, socks, long pants, and a long sleeved shirt. Do not use fabric's synthetic fibers like rayon's, since they melt when hit with a spark.

We start the fire with pieces of wadded up newspaper. Set this in the center of the fire pot and cover it with a mound of coal. You can also add a few pieces of kindling wood beneath the coal to help get it started. Light the paper at several places around its edges, and allow it to burn to a full flame. Turn on the blower, setting the rheostat on a low setting so the air will blow as slowly as possible.

In a minute or so, add more coal to the top of the mound with a small fireplace shovel. The fire should start producing a great deal of yellowish smoke, when this happens, add more coal to the top of the mound. When everything is correct the fire will be like a hill of coal, with thick smoke coming out all over it with small with yellow flame breaking through here and there. Don't play with the fire, but allow the fire to burn like this for several minutes.

After it burns like this for a couple minutes, throw a couple more shovels full of coal onto the fire. A supply of coal around the outside edge of the fire, and dampened this coal thoroughly with water. Fill the perforated can that has a dozen or more small nail holes punched in it, from the bucket and dribble water over the coal. The heat of the forge will burn off the volatile



## THE ADVANCE KNIFE MAKERS MANUAL

components in the coal and the water will keep it from smoking. As the fuel in the fire pot is used, we replace it with this coke from around the edge of the fire, as you add it, add more coal and repeat the above process.

Now with a steel rod, very carefully poke a hole into the cone, at its center you should see a red orange core of bright burning embers. This core is where the fire is the hottest and most intense and is where we will lay the steel to bring it to forging heat.

How long the fire will last depends on the quality of the coal, the force of the blast, the size of the tuyere. When we are heating the steel to a red heat in preparation for striking with a hammer, the blower should be on. With the blower on, the coal is being rapidly consumed, but just before we remove the steel from the fire, we turn off the blower.

When done with the forging, if you will be firing it up again within a couple days, pile coal high on the fire. This will turn into coke and give you a head start on your next fire. If you are not planning to do any more forging for a while, just pull any usable coal off the fire and let the rest burn itself out.

### FORGING

We all know that there is no better teacher than experience. After a little time using the forge, you will begin to get an understanding of the operation if you are paying attention to what is happening with each piece of steel. You will know how wide you can make a blade from a 2 inch rod, how long you need a handle to keep you comfortably away from the fire, and much more.

# THE ADVANCE KNIFE MAKERS MANUAL

## FORGING STEEL

Usually the forging starts with a straight bar of tool steel about 2 feet long. A car leaf spring is a good source of steel, and can be found at scrap iron yards or automobile salvage yards. A coil spring is a good source for knife blades and I will show you how to unwind the coil. You need to build a large, hot fire and place the spring in the center of it. When about an 8-inch length of the spring becomes a bright red heat, remove it from the fire, and straighten that section. Do this by hammering while it is astride the anvil. When the color has faded, return the steel to the fire and heat another half-foot or so.

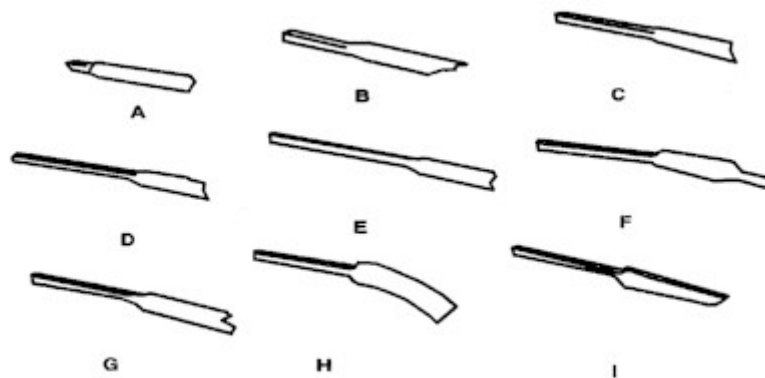

FORGING A KNIFE BLADE

When a section about 2 feet long is straightened, bring the area that you are going to cut off to a bright red. Cut off the piece you will be using, hammer it, at red heat, using either a cutting hardy or against the edge of the anvil. Strike with the flat face of the hammer until a dark line shows through the red of the hot steel. Then bend the crease back and forth until the pieces break apart. Allow the stock to cool slowly until we can handle it.

After cooling, bring the forge to a steady heat. When the fire produces a hot core, slide the tip of the steel bar into the center of the fire pot and bring the last three or four inches to a red orange heat. Now turn off the blower and remove the steel out of the fire, but do not to disturb the fire.

The cross-peen of the hammer is used to direct the flow of the metal from the hammer blows.

If you strike the blows with the cross peen at right angles to the bar, it will push the metal along its length, and will create a longer, thinner bar. On a wider blade, the cross-peen will be struck parallel to the axis, and this will cause the pushing the metal outward and broadening the steel.

Continue to square down the length of the tang, working on all four sides. Always work the steel when it is a bright red. Hitting tool steel when any cooler, risks the creation of internal stresses can show up later in the finished product.

## THE ADVANCE KNIFE MAKERS MANUAL

When the color starts to fade, return the bar to the forge and turn on the blower.

This is also a really good time to ruin the steel, so check the steel regularly by sliding it part-way out of the fire. This slows the heating process and burning it is easy. When the steel burns, it becomes a real sparkler, throwing off a steady stream of sparks. If you strike the steel at this point, it will shatter, sending dangerous pieces in every direction.

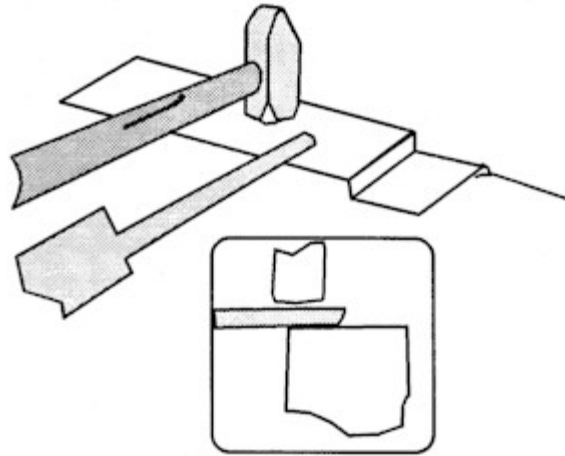

FORMING THE TANG

If you overheat the steel to a point that it is a sparkler, remove it from the fire and allow it to cool for half a minute, and then cut off the burned part and begin again. Quickly set the steel tip on the edge of the anvil, and at right angles to it. Strike the steel with a hard blow this will begin the making and reducing the tang. Start about 2 to 2 1/2 inches from the end.

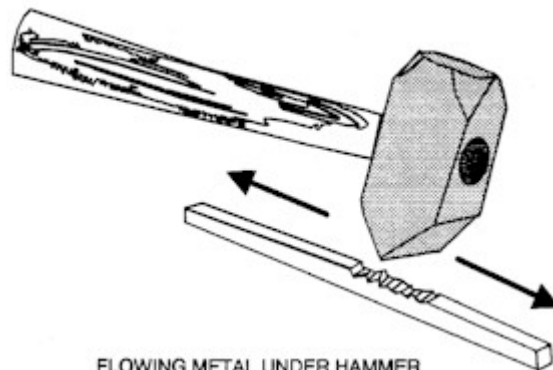

FLOWING METAL UNDER HAMMER

Continue the forging of the tang area, keeping it square, until it is the desired length. This will probably require putting it back in the fire six or eight times to accomplish this. When completed, the tang will be about 6 inches long and about a quarter-inch square.

We then heat the tang to a red heat and further reduced to a rectangular section and the

## THE ADVANCE KNIFE MAKERS MANUAL

longer side lying flat on the same angle with the blade. Be sure that the tang is of uniform thickness all along its length, as the guard should make a snug fit.

The area where the tang meets the blade usually requires very careful fitting. If you leave extra material in this area, we can file it away later, but try to get the proper thickness with a hammer as best you can, as it is faster.

### FORGING THE BLADE

How much shaping that you do will depends on the shape of the steel with which you are working. A rectangular bar close to the size to your intended blade, then very little forging will be needed. If using round stock, you will need to forge the rod into a square section done only at red heat. Most steel that is high in carbon develops a black scale as we heat it. When you leave this scale on the steel during forging, it is pressed into the metal and leaves a very rough surface.

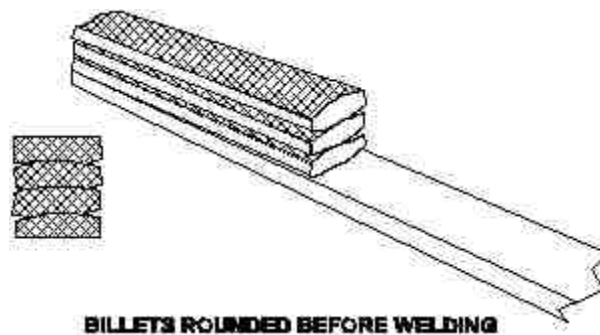

To eliminate this problem from happening, we brush the steel vigorously with a coarse wire brush. Brush the steel when the steel is withdrawn from the fire, and before any blows are struck, and the scale is thrown off in a shower of sparks. On the tang area, you will not have to clean, as it will be out of sight.

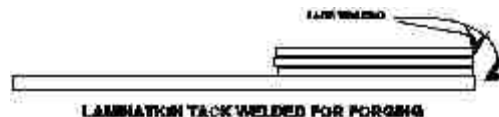

When you have the blade shape forged to a rough shape of the knife, you can cut off the longer bar. This is done by heating the cutoff area to a bright red, setting it against either a cutting fuller or the edge of the anvil and striking it with a hammer.

If the blade needs any additional shaping, it can be done with a hammer, and you will need tongs to hold the blade. We can buy blacksmithing tongs through the suppliers listed at the back of the book. For small work, Vise-Grips can also be used and are handier.

# THE ADVANCE KNIFE MAKERS MANUAL



In reshaping, heat the knife blank to red heat and strike it with the hammer in the required areas to achieve the shape that you want. The edge that is curved down is then struck, and this makes it thinner and causes the curve to straighten out. To finish the blade, beveling will be needed, this can be done by filing, but forging will shorten the time.

Check the blade over, and if the forging is completed heating it to a medium red overall normalizes the steel, and let it cool slowly. Normalizing will allow the grains to assume a uniform size and help to relieve stresses within the steel.

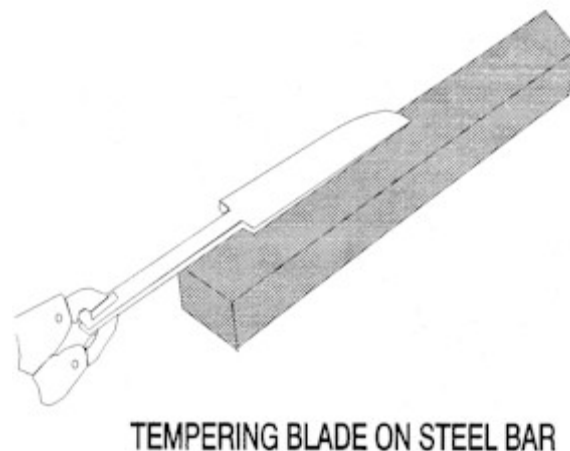

## FILING AND GRINDING THE BLADE

There will be quite a bit of filing and grinding to give a final shape to the blade, even when you become experienced. For the first knives, you should remove much of the excess steel to refine the shape. When the shape of the knife blank is correct, we file the bevel or shape of the blade.

## HARDENING AND TEMPERING

The blade can be heat-treated in the forge or with a heat treat furnace. If you use the forge, build up a bright, hot fire, and then lift away the top coals of the fire to the exposed mound of glowing coals. Place the blade on top of this and watch as it takes on a red heat, but flip it over every so often to even out the heat. After the steel becomes a uniform red orange, quickly pull the blade from the fire and plunge it into a can of thin oil, but be careful that you do not put the blade in an angle.

## THE ADVANCE KNIFE MAKERS MANUAL

Doing this may cause the blade to warp. Move the steel around to ensure that fresh, and we constantly bring cool oil into contact with the steel.

The tempering of the blade at the forge, it is different from when tempering other blades. Lay a heavy piece of scrap steel into the forge to heat up while you belt sand the black oxide film off the blade. Let the large bar get at least a dull red heat, then pull the bar from the fire, and lay it on the side of the hearth. Hold the knife blade with its spine along the bar, when tempering colors first appear, turn over the blade to let it heat evenly. The tempering colors will spread, and when the tempering is complete, we then quench the blade to stop the tempering.

### THE TANG

Now grind or file the tang to a uniform shape, and use dividers measure the thickness and width of the tang; this should be exactly the same size all along its length. However, it can taper away from the blade. Check the tang for length, and cut off any extra length, then the tang is rounded and tapped for the pommel.

# THE ADVANCE KNIFE MAKERS MANUAL

## DAMASCUS STEEL

The steel pieces for making Damascus steel are of two different types, one is a high carbon steel, and the other is a Nickel base lower carbon steel. Some smiths use 2 inch steel cables used on Cranes. If you are using two types of steel, we grind them with a slight bevel, and this is done to help the sloughing off the slag during welding.

Now take the two pieces of steel, placing one on top of the other and tack weld them with either a gas or electric welding machine. The ends of the stack are not usable for the blade, so long enough pieces.

Weld a length of steel bar about 2 feet long to the stack to act as a handle. The handle will make it easier to handle the billet while welding and forging. Making Damascus steel requires quite a bit of shifting of the work in the fire, and a fixed handle works better than tongs.

Start the forge and get a clean medium-hot fire. Try to get what we know as a "cave fire," which is a cone of coke supplied with a generous amount of red orange coals on the bottom. Slide the prepared stack into this cave with the laminates vertically placed, as this will allow any slag or ash to fall out of the seams and will create uniform heating of the steel.

Be sure that all the pieces in the stack reach welding heat simultaneously. The reason for this is the center of the stack will be slower to heat than the outside panels, so they require an even soaking. Watch the heating and flip it over occasionally to achieve uniform heating. Avoid too strong a blast of air, as this will cause the outer layers to heat too much and too fast.

## MAKING THE WELD

Forge welding creates a spray of sparks and hot flux, spraying over an area of maybe 15 feet in all directions. When you get ready to weld, you will want to be completely covered, by wear long sleeves, socks, heavy shoes, and gloves.

The steel will go from red, then bright red, then red orange. When you get to the fluxing heat, which is paler, or what you might call yellowish, it will hurt your eyes to look at. The colors of hot steel can be only be learned by direct experience, so the sooner you start, the sooner you will learn the colors you will see.

## BILLETS ROUNDED BEFORE WELD

To tests the welding heat, set a sample of the steel you will be using in the forge, and observe it carefully.

## THE ADVANCE KNIFE MAKERS MANUAL

Watch when it first starts to give off sparks, as it has just passed over the welding temperature. Do this several times until you learn the color and know what color the steel is just before the sparking occurs.

After the laminates has-reached a uniform lemon color, remove it from the fire, lay the bar across the anvil, and give the steel a vigorous brushing with a stiff steel brush.

Very quickly, apply a good amount of borax flux; this is a white powder that we can buy at a supermarket as a laundry additive. It must be pure borax, and not soap with borax added. Welding supply dealers sometimes carry Borax as a flux.

Hold the hot steel over the container of flux and pour on a good amount over the steel, allowing the excess to fall back into the box, then flipping the steel over and repeat the process. Return the stack to the fire. Bring the steel back up to welding heat. The steel should be set in the fire with all the layers vertical. The reheating should take only a minute or less, so watch closely, because the timing is very important at this stage of the process. Bring the steel back to the lemon yellow color and the flux will be shiny and almost as fluid as water.

Pull the steel from the fire as quickly as possible and shaking off excess flux as you swing it over to the anvil. Now, quickly strike a series of blows in a line down the center of the stack of the steel. Then apply another series of blows along the stack on one side of the center axis. Repeat the process on the other side of the center, moving to the outside edge and striking as rapidly as possible, using shallow blows.

The important thing to remember that the purpose of the blows is to squeeze the parts together, as this closes any gaps and allows the crystals of the steels to join. The flux aids the action by floating away any slag and by protecting the steel from oxidation.

When the weld is good and solid, we grind down all the edges. Allow the billet to cool slowly until we can handle it, and then grind it on a bench grinder.

### **RESTACKING AND WELDING**

Forge the bar to thin it, and this will result in a long bar of a 4-ply piece of steel about an inch wide. Cut it into thirds and the three pieces could then be restacked and welded, that would give twelve layers.

A fine-grained material is stronger than a coarse-grained one, and the more layers meant a much better steel. A Damascus pattern of over four hundred layers becomes difficult to see, and we are tripling the steel with each welding, the layer count increases rapidly.

When we have achieved the number of layers, we give the bar a final forging to straighten it, and we then bring to a uniform red glow and hold it at that temperature for about five minutes.



## THE ADVANCE KNIFE MAKERS MANUAL

We call this heat soaking and will normalize the crystals of the steel.

After five minutes, we then reheat the steel to a medium red and immediately buried in a bucket of lime to anneal it. The slow cooling will relieve the stresses and leave the stock ready for cold working. Go to the chapter on forging to shape the blade.

## FINISHING THE BLADE

After heat-treating, finish the blade with abrasive wheels or buffers, and after finishing, you will etch the blade to bring out the pattern.

### ETCHING

The next step is to reveal the pattern by etching. The acid will also attack and remove one type of steel faster than another, making it possible to create a relief pattern. This causes a color difference of the blade and shows the pattern better.

Degrease the blade before etching with an alcohol-based solvent, and then avoid touching the steel with your fingers. I usually etch with a solution of etchant and water used at room temperature. The Etchant can be found at most Radio Shacks Stores and is a strong acid.

Mix one part Etchant, and three parts of water in a glass container, following the instruction that comes on the etchant. Mix enough that we can submerge the blade completely in the mixture. When etching, hang the blade on a wire and lower it in the acid. Leave it in the acid for twenty minutes and then remove it. The blade will be a jet-black color, which is mostly scum from the acid.

Rinse it off good, and then dip it in a baking soda solution to kill the acid. Rinse off again, take a paper towel, and wipe off the black scum from the blade. After drying, go over the blade with crocus cloth to polish the raised surfaces of the etching. After polishing, the pattern will be very apparent and attractive, all that is left to do is oil the blade and it is ready to finish.

# THE ADVANCE KNIFE MAKERS MANUAL

## REPAIRING POCKET KNIVES

The steady is nothing more than a "cutler's anvil." This tool along with the hammer will be the most used tool in the shop.

The surface is flat with a step down at the front. A hole is at the rear for driving pins out of the bolsters and scales. A slot is at the front for grasping and pulling pins. The thin lip is used for tightening rivets in an assembled knife.

We slide the knife upon the lip with the blades open. This will give support to the back of the rivet while youpeen the top of the rivet.

We should make the steady from a good grade of tool steel and hardened accordingly. A small railroad rail can also be used to make a steady. Your local machine shop can grind the top and step down on a surface grinder. We should drill the hole at the rear approximately 5/16 inch. We can cut out the slot with the cut off wheel of your moto-tool or a milling machine. Be sure to have holes for bolting the steady to a good firm table.

There are two types of hammers that we will need; the first should have a standard face. A 7-oz. tack hammer will do. A cutler's hammer is similar to this but it is like a cross peen hammer, a flat end like a blunt chisel is at the rear. This has great advantage in crinking or bending blades. It is also quite useful in peening bolsters, blades, and springs.

The second hammer can be a regular 7-oz. tack hammer. With your cut off wheel on your moto-tool, cut a section of lines going north, south, and then east to west on the face of the hammer. The tiny square boxes will have a cutting affect on the surface that it will strike. We call this type hammer a cut face hammer. We will need this for peening bolster pins and rivets.

Any good four or six-inch vise can be used. Be sure to get one with removable jaws. We should grind these jaws smooth to prevent damage to your knife while you have it in the vise

## MOTO-TOOL

A moto-tool is also a very important tool used in knife repair. We also need a speed control unit along with the moto-tool. This unit can be used to cut, grind, and drill. Different size collets come with this tool. By using different size collets, you can use drill sizes from .125 down to .040. This tool will give you better control on drilling small holes, even more than a drill press.

We need a drill and wire gage, as with several small drills lying around it is very hard to tell a .082 from a .086. In addition, it is the best way to check pin size without a micrometer.

## THE ADVANCE KNIFE MAKERS MANUAL

We also need a series of number drill sizes that range from 3 inch and smaller. The following sizes will take care of about all of your pin sizes.

You will need a set of small pin punches. We can make standard 3 inch pin punches from a local hardware store into a good set of punches. To make the correct size you need grind these punches down on your belt or drum sander.

### **ALWAYS USE YOUR DRILL GAGE TO CHECK THE CORRECT THICKNESS.**

Also be sure not to allow the punch to become too hot, or it may draw the temper from the steel. Grind a set of punches for the following sizes: .080, .070, .060, and .050. On one punch, grind a blunt end as a center punch. This is very useful in starting to drive or find the pins in bolsters.

A standard pair of end nippers is also a very handy tool. You can pick up a pair of these pliers at your local hardware store. You will need one modification to make on the nippers; the face needs to be ground down flush with the lips. This will enable you to cut pins much closer and give you more ease in grasping pins and rivets.

Vise-grips are very handy to use while grinding and polishing single blades and springs. When a blade or spring is not in an assembled knife, vise grips will make a very useful tool for holding these parts while you work on them.

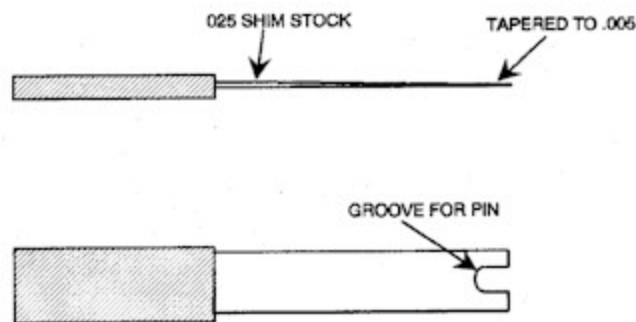

THE SLACKING TOOL FOR FITTING THE BLADE

The slacking tool is used as a spacer when we are assembling the knife. There must be a certain amount of play between the blade and the bolster scales. If there is not, the bolster scales will act as a brake and not allow the blade to move freely.

To have a good tight fit, and to be able to peen the pins snug in the bolster holes, we use a slacking tool to allow for slack between the blade and bolster scales.

The slacking tool is very simple to make. Cut one shim stock about .010 to .015 in thickness. They should be about 2 inch wide and 3 inches long. With a cut off wheel on your moto-tool

## THE ADVANCE KNIFE MAKERS MANUAL

cut a slot or notch  $\frac{3}{16}$  inch wide and deep. This will allow you to slide this tool between and bolster scale while the slot will pass over the pin.

The spreader does exactly as it says. It spreads the blades apart. During assembly if the front of the knife becomes too tight, this will cause the blades to strike each other. It is also used to level the knife, meaning the distance of the backside from scale to scale is the same as it is at the front.

We need two items to make a spreader. An old piece of a back spring and a file handle. Grind one end of the back spring into the shape of a flat chisel point. Sharpen the other end to a point and drive this point into the file handle.

A crinking block is used for crinking or bending blades. The block is used on the steady to rest the blade. The high or low side of the block is used according to which side of the knife the blade you are going to crink is on. This will keep your blade up level with the bolster. With the blunt end of your cutler's hammer, strike the blade directly on the long stamp area; this will cause the blade to bend upwards.

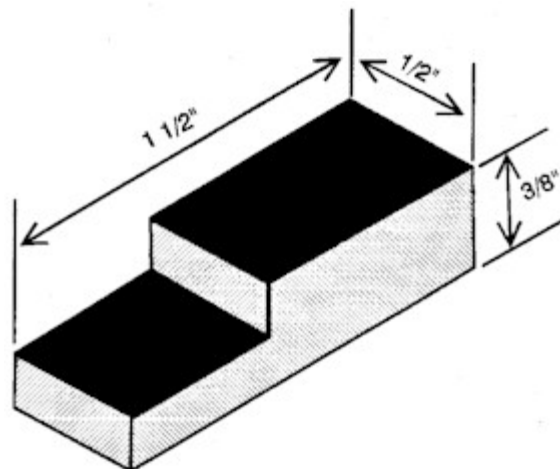

CRINKING BLOCK

**CAUTION** - If you temper some blades past the tang and if you try to bend them, they may break. Always check the hardness with a file before trying to crink a blade. If a small fine file will cut the metal, you should not have any trouble bending it slightly.

We can make a crinking block from a piece of key stock. You will need a different size block for the different size knives on which you will be working. A standard size will be 2 inch wide and 1 2 inch long. Grind one side down. This will give you a high and low side.

You need to make a rivet spinning tool will also. This tool spins the head on pins and rivets. A set consists of two, and one is placed in the chuck of a drill press with the other being stationary in a vise. The center pin or rivet in a newly constructed knife is placed between these spinners. After the top is spun, we turn over the knife and the other end of the pin is

## THE ADVANCE KNIFE MAKERS MANUAL

spun. There are two reasons for spinning pins.

First, it will cause pressure on the back to close it tight. Second, it will form a nice round head to hold the pin and cover scales securely.

The construction of a spinner can be quite simple. We make most of these from a drill rod that is turned in a lathe. We drill the cutting cavity from an 1/8-inch drill. It can either have a slot inside or ground to an angle for a cutting surface.

A very practical way you can make one is from a 3/16 inch set screw that you can purchase from most hardware stores, and a nail set will also work. With your cut off wheel on your moto tool, cut a series of six to eight slots at a twenty-degree angle around the cavity. This will give you your cutting edge. If the cavity is more than 1/8 inch across place the set screw in your drill press and while it is turning, take your file and taper it down. Do this before you cut the slots.

### **MACHINERY & TOOLS FOR KNIFE REPAIR**

To do the grinding on the back springs, blades, and cover scales you will need a belt grinder or drum sander. Belt grinders are the heartbeat of the cutlery industry. They can cut faster and give a better finish than any emery wheel, and they are much safer.

Several companies make belt grinders, but for all practical purposes, one that uses a 2 x 48-inch belt will serve all of your needs. The grit you can choose from will range from 60 to 700. The finer grit belts work very well when removing deep pits in blades.

Another word of advice, make, sure your belt grinder has a rubber contact wheel. This is what gives the uniform finish on your blades.

If you do, not expect to do much grinding a drum sander will do the same job as a belt grinder with less than half the expense. We can mount it on an arbor much like your buffing wheels. One main problem with a drum sander is that you should change the band or emery cloth very often. Recommended speeds for drum sanders six or eight-inch is 1750 RPM.

To set up a train of buffers there are two ways this can be done. You can buy commercial type buffers or you make one with a line shaft, pulleys, pillow blocks, and an old motor. We should thread the ends of the line shaft for locking nuts. One advantage to this system is by placing a set of step pulleys on the line shaft and motor, and you can have a different speed selection. The main speeds for buffing using six or eight-inch wheels are 1750 RPM and 3600 RPM.

Make sure there are no guards around the buffing wheels. We should mount a piece of flat

## THE ADVANCE KNIFE MAKERS MANUAL

bar stock at the back of the wheels to deflect a knife that may become hung in the loose buffs.

A standard 9-inch table disc sander will enable you to sand all of your handle material to a good flat surface. I would also suggest mounting a piece of flat bar stock on the table to act as a guide and will also help hold your work. Disc sanders also can act as a saw to the ends of your handle material. It will grind them to a good straight edge. This is very important when you are hand-fitting handles or cover scales.

A twelve or a fourteen-inch band saw is very handy around the shop. For sawing handle material or for cutting a piece of steel they are quite useful. The band saw can be used to trim excess handle material on scales and save much sanding on the disc sander or belt grinder. The best all around blade size to use is 3 inch width with a pitch or fourteen teeth per inch.

### GRINDING & BUFFING

When grinding or buffing always wear safety glasses. Grinding is the act of shaping, dressing, or finishing material on an abrasive surface. You will note that the quality of the work you do will depend on the handling, movement, and speed in which you grind.

To become proficient in grinding takes practice. Use an old piece of bar stock to grind on to obtain the feel and touch of grinding. You will learn that hard fast grinding causes the metal to heat up and possibly draw the temper. Allow a certain amount of time between each pass so that the metal will stay cool. You can even keep a pan of water close by to submerge the work piece to make sure it does stay cool.

Do not be afraid to grind a knife blade. This is how they shape them at the factories. The blades are blanked out, tempered, and then wet ground. If you should have a blade that has mooned out in the center, you can shape this blade to a good straight surface by grinding it down from the bottom of the edge.

Rust pits and grinding or buffing can remove scratches. Start with a 240-grit belt and work your way down to a 500 or 600 grits. Always be careful and not press too hard with the coarser grits or you will remove more surface than you intend to.

After we have ground the blade on the belt grinder, the facets or lines can be smoothed out on a Grease wheels". This wheel is also quite useful in giving a good even finish between the bolster and handle. You may even discover that a small amount of grinding can be done on these wheels. Again, proficiency will come with practice.

Grease wheels were used in the cutlery industry in finishing blades and preparing them for polishing. Most all manufacturers have now discontinued them for the silicon carbide impregnated nylon wheels. The nylon wheels are very expensive and will not cut any better than the grease wheels. The only advantage is they do not have to be charged or coated as

## THE ADVANCE KNIFE MAKERS MANUAL

often.

A grease wheel is a hard muslin buff, 70-90 ply sewn and glued together. They coated the face with hide glue and then they rolled the wheel in a pan of Turkish emery (depending on the size grit wanted) and then baked. After the wheel was placed back on the spindle, a shaping stone was used to knock off all high points. They also applied a light coating of grease to the surface to give a smoother cut, thus, the name grease wheels.

Today companies produce compounds of glue mixed with emery powder. They make their compounds in either a liquid that we may paint on or a stick that we can apply as a buffing compound. Most all these glue base compounds are water-soluble. By adding a small amount of water to the stick compound you can make a paste and spread it onto the wheel with your hand, thus, giving a more even coating. Another item about the stick compound is that if it becomes hard while sitting on the shaft you can bring it back to the paste stage by soaking it in a small amount of water for a few hours.

I highly recommend grease wheels for use in your operation. They will give a good refinish on about all of the parts of your knife (except for some synthetic handle material). Grit size for glue base compounds will range from 80 to 600. Recommended wheel size should be 6 or 8-inch. The arbor speed will depend on the grit you are using and the type of finish you want. A fast wheel may be better than a slow one on certain operations.

Buffing or polishing is for the most part the final act on repairing or building a knife. There are many different systems and rarely will you find any two alike. Some will consist of a high speed with ninety ply muslin or felt wheels while others will have a slow speed with loose twenty ply stacked muslin wheels.

There is also a factor in the size wheel you use; an eight-inch wheel at 1750 RPM will have a greater surface speed than a 6-inch wheel at 1750 RPM. You can change the SFM by changing the motor speed, different pulleys, or diameter of the wheel. To find out the surface speed in feet per minute multiply the diameter by 3.1416, by the RPM, and then divide by twelve.

$$\text{Diameter} \times 3.1416 \times \text{RPM} = \text{SFM} \div 12$$

Remember that buffing is an act of polishing. With buffing compound on a loose muslin wheel, you are only going to remove a very small amount of material in a short period. Therefore, it is very important that you have your work ready for buffing. Buffing will not remove deep scratches or pits in a blade, nor will it cut down handle material at the bolster seam. Using fine grit on the grease wheel should take down the blades and handle material to a semi polish.

Buffing compounds comes in cakes or bars. It consists of fine aluminum oxide and other polishing agents. They hold it together in a bar by a type of hardened grease. Do not confuse this with the Grease wheel, which is used in grinding. It is a glue base compound,



## THE ADVANCE KNIFE MAKERS MANUAL

whereas buffing compounds are grease base compounds.

The compound needed for buffing will depend on the type steel with which you are working. There are different compounds for carbon steels and for stainless steels.

To coat or charge your buffing wheels simply touch the bar to the bare wheel while it is running. We will remove a small amount from the bar and stick to the wheel. We will need two buffing and polishing wheels. We should coat the first with a coarser compound, or a cut compound. This compound will give a very light polish to the metal. The second is for color that will bring out a bright luster. You will find that most of the cut compounds are gray in color and the color compounds are white.

Hard muslin 70-90 ply sewn or hard density felt wheels 6 or 8-inch at a speed of 3600 RPM can be used to polish blades. They do not recommend these wheels because they will cause the blades to become too hot while buffing. Also, there is a danger in buffing with these type wheels going at this fast speed.

Loose wheels at a speed of 1750 will give a much better finish on blades. We also need them for composition handles. High speeds on hard wheels will cause these plastic handles to melt or smear. The loose wheels will give a bright slick finish to these materials. Bone, stag, and pearl should also be buffed on loose wheels. Again, the hard wheels at fast speeds will cause these materials to show burn or dark brown spots.

Whenever buffing with loose wheels, always hold the blade in a vertical position with the wheel. Since you have ground it in a horizontal position, the scratch marks can be more readily buffed to a smoother finish with cross buffing. Another reason to buff blades in the vertical position is that of safety. Hanging the top of a blade in the loose buffs is very easy while buffing it horizontal.

The first step you should take before working on any type of knife is to dull the blade. Do this by striking the edge with a file. In addition, it is a good idea to clean this knife with very light oil to remove the excess dirt and grease that may be wedged between the blades and scales. You will find that this will aid in the disassembly of the parts.

To break a knife down to the component parts you must cut the bolster and center pins. To cut a bolster pin, close all blades of the knife and place an old blade or cutting blade between the tang of the master blade and bolster scale. Set the knife on a piece of leather or hard plastic and strike the top of the cutting blade with your cutler's hammer. This will drive the blade through the bolster pin.

## THE ADVANCE KNIFE MAKERS MANUAL

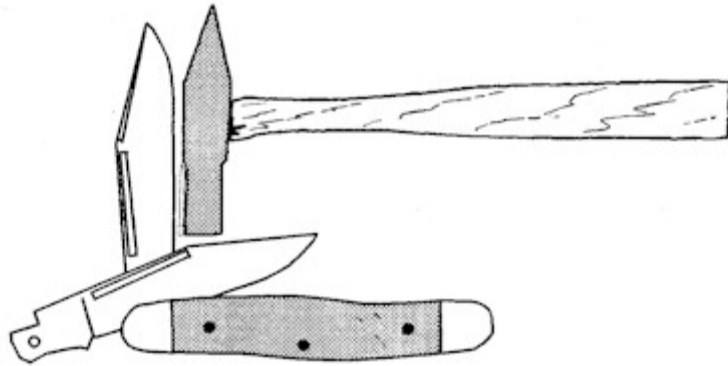

CUTTING THE PINS

The next step that we should take is the removal of the center pin. With a ball cutter on your moto-tool cut the head of the center pin. Lay the knife on the steady with the back of the pin over the end hole of the steady. Now you are ready to drive the pin through with the pin punch.

Sometimes you may want to remove the center pin first. The only problem you may encounter is tension on the springs and handle material. There is a greater danger of breaking a handle in this operation. To help avoid this, after you have removed the pinhead with your ball cutter, open all blades and place the knife in your vise with all blades open. This way, the jaws of the vise are giving tension to the back springs. Now you are ready to drive the pin out with a punch.

If the knife consists of double end springs, mark the sides of the springs and scales before we remove them. Replacing these springs to the same side that they were on will be easier before removal. Although these springs may look the same, there may be some differences in the way they ground them.

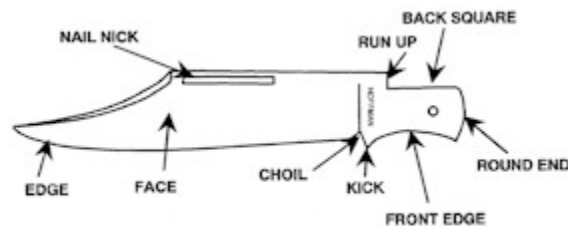

PARTS OF A BLADE

Some types of knives made today are made with a keyhole construction. The name comes from the way the bolster scale looks on the inside. These knives do not have a through bolster pin. The bolsters are hollow and the scales have a slot for the bolster pin to lock in. We assemble the blades, springs, and center scales with large steel pins.

## THE ADVANCE KNIFE MAKERS MANUAL

The heads on these pins are similar to nail heads. These heads lock into the slots and the tension holds together the knife of the springs and center pin.

To disassemble this type of knife, first remove the center pin. Slide the mark scale in one direction and the pile side in the other. This will allow the large bolster pinhead to fall out of the bottom slot.

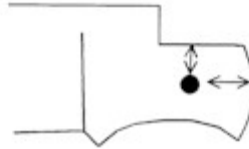

LOCATION OF PIN HOLE IN BLADE

Always check the position of parts before you assemble a knife. It is not uncommon to find you have placed a blade in a knife upside down or you have placed a butt spring in at the wrong end. Do not try to work on both ends of a knife simultaneously. After we assemble the parts into position, with your slacking tool between blades and scales, peen the bolster pin of the first end and then the other. Make sure the back springs are in place. This will prevent the knife from warping.

After we have peened the bolster pins, place the knife in your vise with all blades open, mark side facing up. A good angle for the knife to lay is about 45°, and then compress the springs by closing on the vise. Check the hold line-up with a pin punch. You are ready to drive your pin into place.

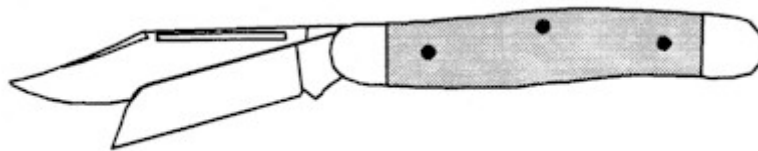

CORRECT ANGLE BACK ON KNIFE

The main problem a knife repairman has is finding blades. One might find a blade that seems to match the same shape as the one he is going to replace, however problems encountered maybe blade thickness, hole position, Back Square, and a round end.

I have even seen some people even try to weld blades together, if successful, there will always be a weak point at the weld. The main reason this is done is to save the tang stamp. It is much better to replace a blade with no tang stamp rather than welding blades.

To replace an old blade with one that does not match, place the two blades together and insert a pin through the pinholes. Now clamp them together at the end with your vise grips. With the two blades locked together, you can now use the old blade as a pattern to grind your

## THE ADVANCE KNIFE MAKERS MANUAL

new blade. Use a file to shape up the run up, back square, and round ends.

The round end of a blade acts as a cam to raise or give tension to the back spring. If the distance from the round end to the center of the pinhole becomes equal to or less than the distance from the back square to the center of the pinhole, there will be no tension from the spring. This can be corrected by welding a small amount of vanadium steel to the round end. After the weld has been placed, shape it down by filing. Be careful and not add or remove metal to the back square because this will raise or lower your back spring when the blade is open.

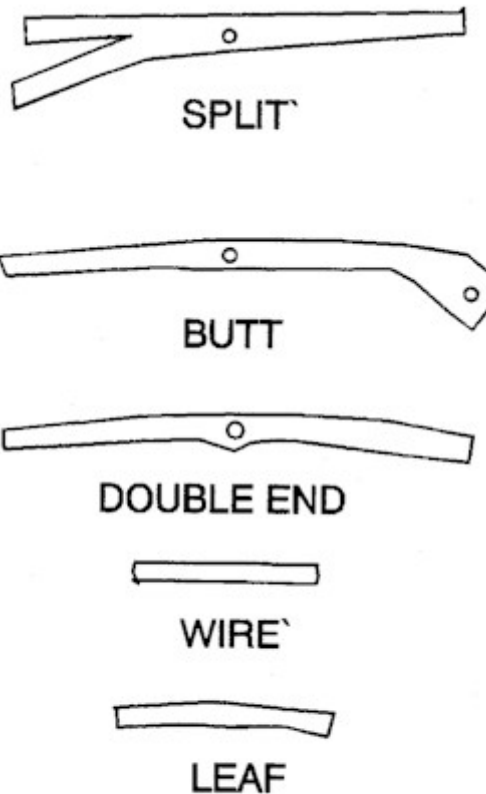

### TYPE OF KNIFE SPRINGS

The kick is responsible for the height of the blade when it is in the closed position. To lower a blade, simply grind off a small amount of metal at the end of the kick.

There are two ways to raise a blade. The first is to spread the tang by hammering the end of the kick. This will increase the length. The second way is to punch or stamp a dent into the spring where the kick will hit. This will also give rise to the blade.

After you have assembled the knife and the blades are still too tight, you can loosen them by slackening the blade." Place the blade on the steady in a horizontal position. The rest of the knife should be in a vertical one. Tilt the blade upward to a 20-30 ° angle. With your cutler's

## THE ADVANCE KNIFE MAKERS MANUAL

hammer, strike the kick first, rock the blade to where the angle is to the reverse side, and then strike the backside.

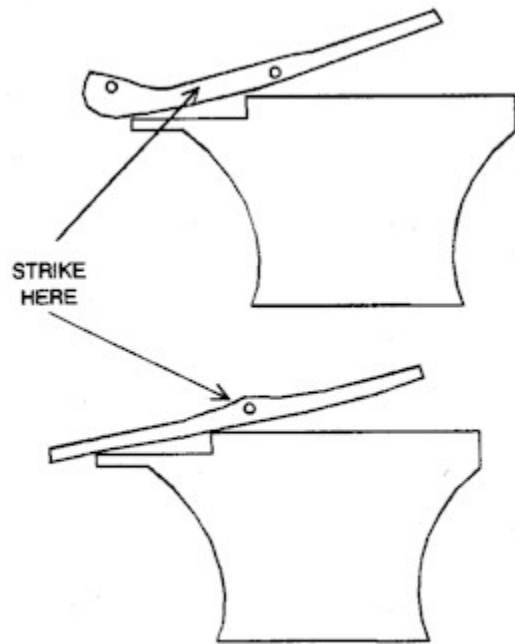

ADDING TENSION TO A SPRING

Angle Back refers to the position of the top of the blades in relation to the back spring when the blades are open. The blade or blades will not have good angle back if they go too far back or not back far enough. A good angle back will be a straight line up of the top of the back springs and blades.

To correct a problem of an angle back, we can adjust the blade or back spring. If a blade will not come back far enough, you can grind a small amount off the end of the back spring. This will allow the blade to come back more. Grinding a slight amount can make the same adjustment off the run up of the blade.

If a blade comes back too far, lay the end of the back spring flat on the steady and with your cutler's hammer, peen the end of the back spring. This will stretch the metal at the end of the back spring and allow the back spring to stop more forward when open. To compensate for more forward adjustment, peen the run up of the blade.

There are five types of springs used on folding knives. The butt spring is used for the operation of only one blade. The double-end spring is used for two blades. The split spring can be used in the operation of three blades and some lock backs. Infrequently you may find a double-split spring that can operate four blades. The leaf spring is used to give tension on a locking-lever in lock back patterns. A wire spring will act as a leaf spring, and the only difference is that we make it from a piece of hardened round stock instead of being cut or blanked from flat sheets.

## THE ADVANCE KNIFE MAKERS MANUAL

In production springs are blanked from flat stock and then hardened. The hardness will depend on the type spring it is. You will find that the hardness of springs will range from 37 Rc to 49 Rc. Some foreign-made springs will be even harder. Remember that the harder the spring the easier it is to break.

For replacement of a spring, use the old one as a pattern and grind the new one to fit. Be careful and not allow it to become too hot for it may draw some of the temper. Also, note that the back spring for a blade will always be slightly wider. This helps give slack to the blade for free movement. A back spring that is too wide will allow too much slack where one that is too narrow will allow the bolster scales to be too tight on the blade and prevent free movement.

Adding bending the spring can give more tension or strength to a back spring. Place the spring facing up on the steady with the butt end on the slope. With the blunt end of your cutler's hammer, strike the spring uphill of the center pinhole. This will give the spring a slight bend and therefore have more tension. Be careful not to bend the spring too much because the more you bend a spring the shorter it will become in length and therefore will affect the angle back.

# THE ADVANCE KNIFE MAKERS MANUAL

## CASTING PARTS

I have included this section for the knife makers who are serious about starting a business. The following chapters will show you different techniques that can be used for mass production, with a minimum of cost.

Why cast when you can already buy the parts already made? For many of you that depend on your work for your income, or for the others that need a much needed extra income, casting can make you money. If you make a special design of knife and the handle parts that is time consuming to make, you might like to consider casting. By casting, you only need to make one pattern, and then cast duplicates of this part.

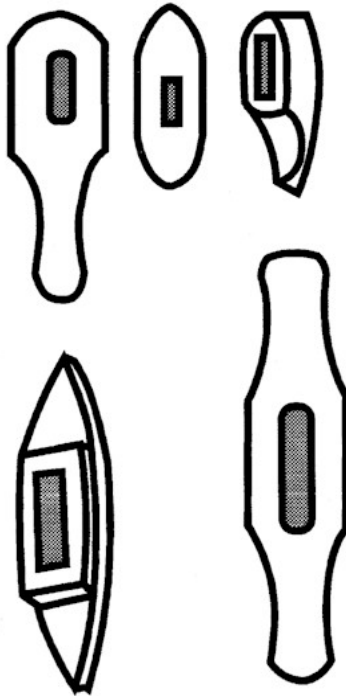

**TYPE OF KNIFE HILTS  
THAT CAN BE CAST**

What casting does is to save you much time in the finishing part of your business. For the knife maker, knife handles can be cast right on the finish blade.

By doing this, you save much time and work per each knife, thus more profits. This is true in the gun business and other types of business.

With the type of castings I described in this book, finished parts can be produced once the mold is completed. All the parts will be the same from one casting to another. Do you have an idea on some type of product that you think would sell well, but do not have the money to develop it? There again you can produce the item in the shop, test it on the public, and make

## THE ADVANCE KNIFE MAKERS MANUAL

modification on it to improve it. To do this it only takes a little time and very little money.

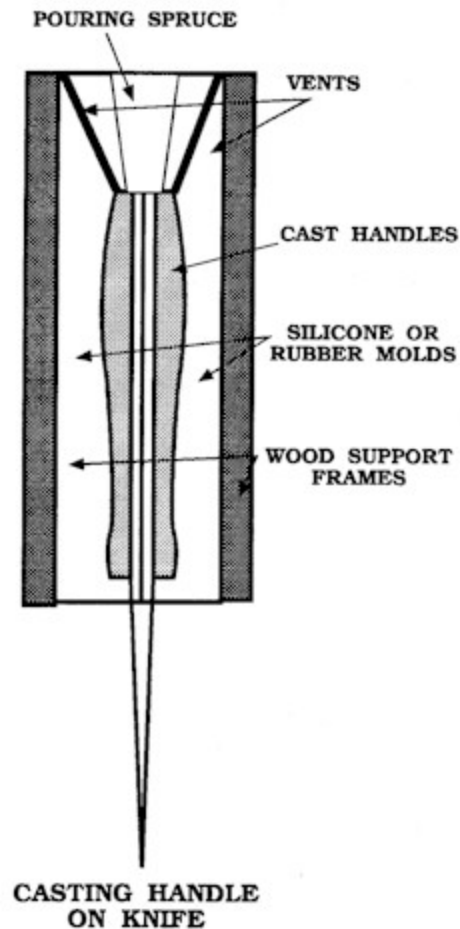

We can make grips for guns with the checkering already on it, and other inserts that are in the grip. We can also make completed knife or sword handles just as easily following the process described. Plaster casting can be used on most items that will be cast in metal and require finishing on the outside. Silicone and Latex molds can be used for casting plastic or making wax patterns for investment castings.

\* Investment casting is used where you want a finish product that will require very little to no machining.

\* Investment casting is what they make statues and other large item, so you see size is no problem.

\* Investment casting is used extensively for small jewelry casting, and small parts.

Silicone molds work great for casting grips, knife handles, and finish knife handles on knives. Silicone is very durable and will cast several hundred items before it has to be replaced.



## THE ADVANCE KNIFE MAKERS MANUAL

We are in the age of plastics, and by contacting various makers; you can probably find just about any type of material that you want. You can put various types of material in the castings for appearance and for making the product tougher.

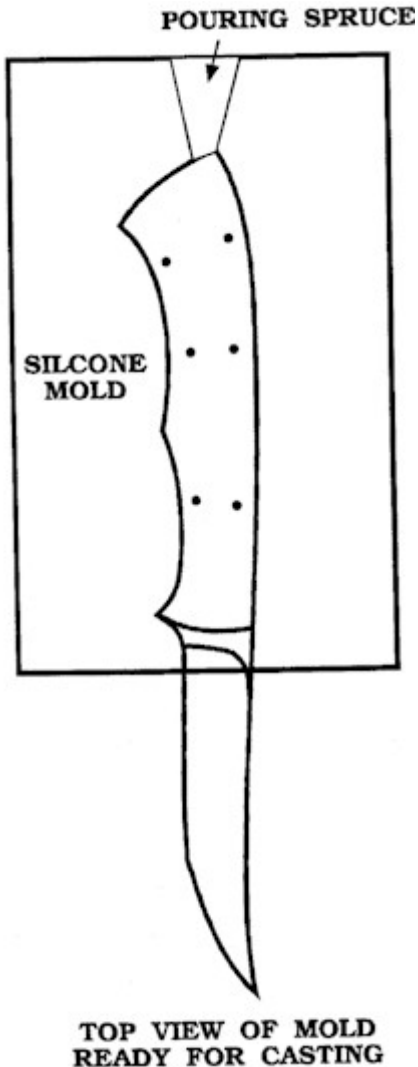

When you add filler to plastics, it will thicken it to a point that you may have to make a pressure machine as described for investment casting. The pressure machine will guarantee perfection for each finish part that you produce. It will need to be altered for your application, or a special one made.

You will find that this book will open a whole new area for you for making additional money and much enjoyment. Women will find that they can make many different items for craft show.

## PATTERN MAKING

If you are going to make small parts or large parts in quantity, casting the parts is much easier. By doing this much machining time can be eliminated. Once we make master patterns, they can be used indefinitely for making additional cores. In most cases for the best finish and accuracy, it is best to use plaster for the molds. It will take a little bit of designing to get the core made for the inside of some types of parts.

## MATERIALS

The best wood for making patterns is mahogany, but sugar pine is next best. Some varieties of white Pine are also good, but as a rule they have more grain than sugar Pine. They are harder to finish to a smooth surface with no grain showing through. They must thoroughly season the wood.

You should buy one plank 2 inches by 12 inches and one 1 inch by 12 inches and have them surfaced on two sides as thick as they will finish. Wood more than 2 inches thick may not be thoroughly seasoned all the way through, and this can cause trouble. Sections thicker than 2 inches should be made by gluing up laminations. You can get your clamps for gluing from a hardware store, as well as good furniture glue.

## DISC PATTERN

If you want the casting to come out as cast to the correct dimensions, we must make the pattern larger and thicker to compensate for the amount that the metal will shrink when going from a liquid to a solid. They call this pattern shrinkage. We must lay out and cut all dimensions of the pattern accurately, working to an accurate line. Since the hot metal will shrink as it cools, making the pattern slightly larger than the finished casting is necessary. Brass and aluminum shrink about  $\frac{3}{16}$  inch per foot.

You can use an ordinary scale to measure the work and make allowances for shrinkage, but purchasing a shrinkage scale would be better and use it for all measurements. These rulers are made of steel and having been worked proportionately over its length to compensate for the shrinkage. Thus a  $\frac{3}{16}$ -inch shrink rule 12 inches long will be actually  $12 \frac{3}{16}$  inches long, but will look like a standard rule.

When laid out against a standard ruler it will project  $\frac{3}{16}$  inch past the standard ruler. Usually the shrinkage allowance for brass is  $\frac{3}{16}$  inch per foot, and 3 inch per foot for aluminum. So if we wish to cast a bar in brass 1 foot long, we must make the pattern 1 foot and  $\frac{3}{16}$  inch long to start with. These scales are graduated for the amount of shrinkage, so get a scale made for the kind of metal to be cast. This varies with each type of metal and the shape of the casting.

# THE ADVANCE KNIFE MAKERS MANUAL

## MACHINING ALLOWANCE

The disc we want in brass requires that the outer diameter of the casting is to be machined (the 12-inch dimension is a machined dimension). We must then allow for machining to our 12-inch dimension. This allowance must be in addition to the shrinkage and draft allowance, taken at the short side of the pattern or smallest diameter.

We must have a pattern dimension of 12  $\frac{3}{16}$  inches, the  $\frac{3}{16}$ -inch to allow for shrinkage plus  $\frac{1}{16}$  inch for metal to come off. Therefore, we need an actual diameter on the small end of our pattern of 12 d inches.

If we dimension our layout as 12 and  $\frac{1}{16}$  inch (the  $\frac{1}{16}$  inch for machining) and we use a  $\frac{3}{16}$ -inch shrink ruler to measure this dimension, then when you build the pattern it will come out right.

## MASTER PATTERN

If we want to make one or more production patterns out of cast aluminum or brass, from which we intend to make several aluminum castings. We need a wood pattern from which to cast other production pattern. If we wanted as our finished product, a cast aluminum disc, we would have to make our wood pattern with a double aluminum shrink rule or 2 inch per foot shrinkage.

We are going to take 3 inch shrinkage in going from our wood pattern to our cast pattern and another 3 inch to our end product. They call these rules double shrink rulers. If we were going from a wood pattern to an aluminum production pattern to a brass casting as an end product, the shrinkage allowance on your wood pattern would have to be  $3 \times \frac{3}{16}$  or  $\frac{12}{16}$  inch plus finish. This type of wood pattern, they call the wood a master pattern, a pattern from which they make the production pattern or patterns.

## SPLIT PATTERNS

This is a pattern that we make in two halves split along the parting line. The two halves are held in register by pins called pattern dowels. The pattern is split to simply molding. The dowels hold the two halves of the pattern together in close accurate register, but also are free enough that the two halves can be separated easily for molding, like the pins and guides of the flask.

In the following paragraphs, we will cover the making of the pattern. Since the pattern will be split on the centerline, we must glue the stock up thick enough for each half and long enough to allow for turning. One edge and one face of each half is finished straight and flat. With a marking gauge, scribe the centerline down the inside face of each half. Dowels are used to align both halves after they are separated.

## THE ADVANCE KNIFE MAKERS MANUAL

Some patterns are not the same on both sides; you must decide which side of the pattern is to be up when it is placed in the mold. Since the bottom half of the pattern is placed on the moldboard as we are ramming the drag, this half should have the dowel holes, and the top half will have the projecting dowels. We usually install the dowels off center so that we can only put together the pattern correctly.

### DOWELS

We bore the dowel holes from the inside of the top half, on the center line, they should be placed asymmetrically so that there will be only one way in which we can put together the pattern. We should bore these holes in the drill press so that they will be square with the face of the work. Clamp the two halves together, lining up the center marks on the ends, and bore the dowel holes in the bottom half through the holes in the top half as guides.

We cut the dowels to the correct length and pointed. They should be long enough to fill the holes in the top half completely. Before driving the dowels into the top half, try their fit in the holes in the bottom half. So that the two parts of the pattern will separate easily in the mold, the dowels must be an easy sliding fit in the holes, but must still be tight enough to prevent side movement. Sandpaper the end of the dowel until it slips easily in the hole.

The point of the dowel should not be too long. As we lift the cope off the drag, the sooner the dowels are free from the holes, the less danger there is of damaging the mold by moving the cope sideways and catching it on the dowel, thus tearing the pattern out of the sand. A projection of  $d$  inch with half of it in the tapered point and the rest full size to fit the hole is about right.

Holding the halves of the pattern together while we are turning it, long wood screws are placed through the wave wood at each end. Whatever method you use, make sure that we fasten securely enough to stand the centrifugal force of spinning in the lathe.

You must accurately locate the holes for the lathe centers at each end. Use a center punch to start the hole and drill small holes to receive the points of the centers. Be sure we hold the work tightly on the centers, check that the tail center is locked so that it cannot separate and allow the work to fly out of the lathe. Start with a slow speed until the pattern has been roughed down to the largest diameter of the pattern.

Turn it to the same diameter along the full length. Lay off the several lengths of the pattern with the shrinkage scale and spin the work while holding the point of a pencil against it to mark it all the way around. The pencil marks are just guides lines for rough turning. After roughing out the entire pattern, finish turn one end as a starting point to make be final measurements.

In measuring the distances between points on the pattern, adding up all the individual distances so that we have made all measurements from one end. This way, we will eliminate

# THE ADVANCE KNIFE MAKERS MANUAL

errors of individual measuring, and the overall distance can be checked. Add up the distances and mark them on the drawing of the casting, being sure to add in the thickness necessary for finishing. Since the line on the drawing is the finished dimension, you must add the amount to be turned off in finishing the casting. One-sixteenth inch is a good amount to allow for finishing, unless the shape of the casting is such that it may warp in cooling, in which case they must allow a greater amount.

## **MOUNTED PATTERN**

When we mount a pattern to a board to make it easier for molding, they call it a mounted pattern. Now, the mount has on each end guides that match up with the flask used to make the mold. The plate is placed between the cope and drag flask, the drag rammed and rolled over. We now ram and lift the cope off, the plate with a pattern attached is lifted off the drag half, the mold finished and closed.

## **MEDIUM PATTERN**

A pattern used only occasionally or for casting a one-time piece is usually constructed as cheaply as possible. A core is a preformed baked sand or plaster inserted in a mold to shape the interior part of a casting that the pattern couldn't shape. The dowels hold the two halves of the pattern together in close accurate register, but also are free enough that the two halves can be separated easily for molding.

We usually install the dowels off center so they can only put together the pattern correctly. When a pattern requires a core, we must make a projection on the pattern, this projection forms an impression in the sand or plaster of the mold in which to locate the core and hold it during the casting. They call these projections core prints and are part of the pattern. Sometimes making a pattern is possible so a core will remain in the sand when they remove the pattern, which is the usual way for gun frames.

## **PARTING LINE**

On the pattern, the upper face of the pattern is designated as the parting line or parting face. A line or the planes of a pattern corresponding to the point of separation between the cope and drag portions of sand molds. The parting may be irregular or a plane, as the mold must be opened, the pattern removed and then closed for pouring without damage to the sand or plaster. The parting line must be located where we can accomplish this. We must draft the portion of the pattern in the cope so we can remove the cope and the same of the drag.

## **DRAFT**

When I use a simple disc pattern, the object we want to cast is 12 inches in diameter and 1 inch thick. We taper the edge of the disc from the top face to the bottom face. They know this taper as the pattern draft. This draft is necessary so they can remove the pattern easily from the mold causing no damage to the sand. They define pattern draft as the taper on

## THE ADVANCE KNIFE MAKERS MANUAL

vertical elements in a pattern that allows easy withdrawal of the pattern from the mold. The amount of draft required will vary with the depth of the pattern. The general rule is a c inch taper to the foot that comes out to about 1 degree and on shallow patterns such as our disc 1/16 inch taper or zero, but 5 degrees is sufficient.

### CORE PRINTS

We support the core in the mold in hollows made in the sand by the core prints. These are the same diameter as the cue and should be about as long as the diameter of the core. They bevel the ends of the cue points to the draft angle. The core will have a vent hole down its center, and the gas and steam must be collected and carried out of the mold. Making the core print on the cope half about 3 inch longer than on the drag, and then making the core the length of the drag half. This will leave an 3 inch space at the end in the cope to collect this gas. They make the cue to fit the bottom half so that it will be accurately located in the mold. This extra space at the ends of the core in the top half makes it easier to place the cope over the drag when closing the flask.

Some cores may be located in the mold in one position only. To place the core correctly, a flat place is left on the side of the cue print. A similar flat place is left on the cue so that there is only one way the cue can be placed. When the casting must be set up for machining in one particular way, locating marks are built into the pattern. An oval hollow on the inside of an otherwise round casting. There should be two such marks as far apart as possible. The guide marks should both be on the same part of the pattern, preferably on the drag. As there may be a shifting of the parts of the mold that would throw the guide marks out of line.

### FILLETS

All angles should have fillets, and when possible, turn these fillets in the lathe. Other places must have fillets fitted by hand. Pattern shops use wax that they extrude from a machine in the shape of the fillet. Plastic wood is best for the home workshop. They work this into the corner with a round end tool. Plastic wood will set too fast to be handled as it comes from the can, so have a small container of alcohol to dip the tool in. Alcohol is a poor solvent for plastic wood, but will keep it moist and slippery long enough for you to work it to shape.

Removing the fastening in the waste wood can now separate it at the ends. We lay the lengths of the finished core prints of, and they cut the ends on the saw table to the bevel of the draft. The table saw will probably not cut high enough to cut all the way through the core print, but it can be done on the band saw. Laying out a line on the top of the curved core print to guide the saw will be necessary. Setting up a board to the required bevel and butting the end of the core print against it so that the print is exactly square with the board. Set the dividers or hermaphrodite calipers to the proper distance and scribe a line over the core print parallel to the board. Saw just outside this line and finish by sanding on the sand disk to the scribed line.

On completion of the turning of the pattern, then we sandpaper it to a perfectly smooth finish, and all dimensions are checked. It should now be finished with a good lacquer finish and

## THE ADVANCE KNIFE MAKERS MANUAL

polish to a high finish for plaster molding. One or two coats of a good floor wax will further seal it. Since the dowels projecting from the top half of the pattern will be in the way, they make a false bottom from a piece of wood with holes for the dowels so that the pattern will lie level on the table for sawing and sanding. The holes do not have to fit tight on the dowels.

# THE ADVANCE KNIFE MAKERS MANUAL

## CRUCIBLE FURNACES

### NON FERROUS METALS

Usually, if you do castings of parts, you will probably use aluminum or brass to do so. They melt nonferrous metals in many types of furnaces. The crucible furnace is the most common and lowest in initial cost.

The furnace is essentially a refractory-lined cylinder with a refractory cover, equipped with a burner and blower for the intense combustion of oil or gas. They melt the metal in a crucible or pot made of clay and graphite, or silica carbide, which is placed in the furnace. When the melting is complete, they turn off the furnace, the furnace cover is opened, and the crucible removed with tongs and placed in a pouring shank. Then they pour the liquid metal into prepared molds.

### CRUCIBLE FURNACE CONSTRUCTION

We can make a crucible furnace from an old metal drum, a few pipefittings, the blower from an old vacuum cleaner, and twenty to sixty dollars worth of castable refractory material. The refractory suppliers can also furnish you with complete advice on what to buy for your particular purpose, along with tips and how to handle the material. Crucibles come in sizes from as small as a cup to several hundred pounds.

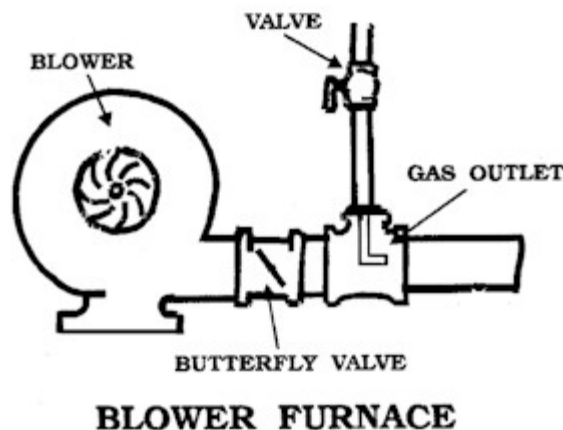

Homemade melting furnaces are simple to construct, and are easy to build and operate. A furnace for a No. 20 crucible, which has a capacity of 60 pounds for bronze, or 20 pounds for aluminum, would be considered average in size.

By weight, crucibles will hold three times as much bronze as aluminum. Always allow some clearance below the top of the crucible for safety-it is dangerous to melt a brimming pot full.



## THE ADVANCE KNIFE MAKERS MANUAL

You have chosen a No. 20 crucible, 10 2 inches high, 7 1 /3/16 inches across the top and bottom, and 8 2 inches at its bilge, or widest point (its shape resembles that of a barrel). This crucible requires a base in the form of a truncated cone 6 inches across the top, 7 inches across the bottom and 5 inches high. We have 15 inches of high and 8 inches in diameter to go in the flame.

There must be sufficient distance between the crucible and furnace lining for correct combustion and for room to fit it open tongs around the crucible. Also, they need enough space between the furnace bottom and the covers for correct combustion and exhaust through the cover opening. A good rule here is to allow 2 2 to 3 inches of clearance between the furnace wall and the bilge. Then 3 inches between the top of the crucible and the cover and above the furnace bottom. The lining should be a minimum of 4 inches thick to insure good insulation.

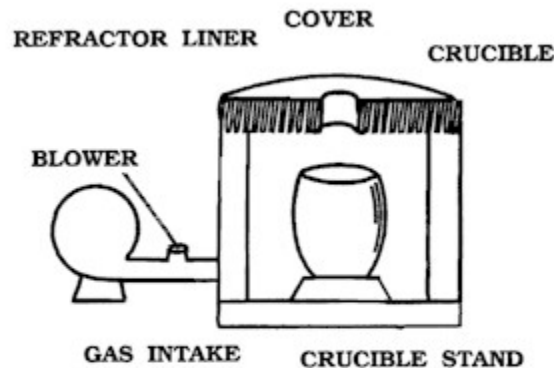

### MELTING FURNACE

With this, we need a shell for the furnace 22 inches (inside diameter) by 22 inches high, with a cover band 22 inches (inside diameter) by 4 inches in height. They need a safety hole directly in the front of the furnace, flush with the bottom and 3-inch square. Should the crucible break, the metal would run out of the furnace through the hole.

Without a safety hole, metal could run into the burner pipe, or simply fill the bottom of the furnace and solidify there. If it does, it will leave you with a block of metal next to impossible to remove without taking everything apart.

Making a 3-inch hot 6 inches completes the shell above the bottom of the shell, a third of the shells circumference away from the safety hole. This is where the burner pipe enters. We bring the burner pipe in 2 inches above the refractory lining of the bottom, and off center from the diameter of the shell. Then the flame coming will circle the space between the crucible and the lining, spiral around the crucible, and out of the vent hole, this gives the highest and most even heat.

### COVER

## THE ADVANCE KNIFE MAKERS MANUAL

The cover consists of a metal band formed into a ring 22 2 inches in diameter, but tapered slightly. You must rivet the lifting ears on directly across from each other on the cover ring. We should drill them with holes to clear an 2 inch pipe, which will be used to remove the cover.

The cover ring is placed on a smooth floor covered with newspaper in preparation for making the exhaust hole.

Within the center of the cover ring, place a number 6 tin can or jar as a form for the exhaust vent. We now mix the castable refractory according to the manufacturers directions, tamped firmly in place around the vent form. It is then leveled off smoothly with the top of the ring, and let to set overnight.

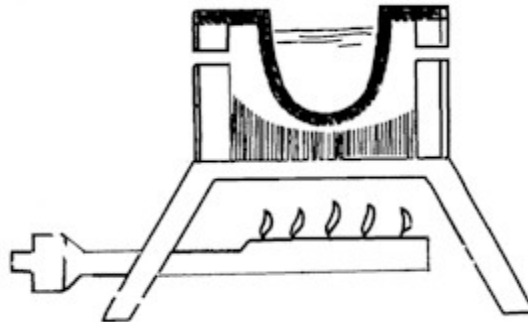

Now you can to line the furnace body. Place a heavy cardboard sleeve 14 2 inches in diameter and long enough to extend slightly above the top of the shelf in the center of the furnace, 22, or 23 inches tall should do.

Once the sleeve is centered, fill the inside of the sleeve with dry sand to give it added strength, and hold it in place while tamping in the lining all the way to the top. We will need two plugs for the furnace shell while we are installing the lining. One, to fit through the safety hole and against the cardboard sleeve, and another to fit the burner port.

Coat each plug with heavy oil or grease, and fit both into their respective places. Use small wooden wedges to get a snug fit. With both plugs securely in place, start tamping in the lining, making sure the castable refractory is well compressed. Do not place too much material between the sleeve and the shell at a time, as doing so will produce spaces. When we reach the top of the shell, trowel and smooth the refractory. The furnace is now complete.

Now we must have a suitable burner and blower-a blower that will deliver 3M cubic-feet of air per minute. A good blower, particularly one from an industrial vacuum cleaner, will deliver enough air at the right pressure.

We can make the simplest type of gas burner easily in the shop. There are many types, and the drawings will give you some ideas. We must provide the intake of the blower with a

# THE ADVANCE KNIFE MAKERS MANUAL

shutter or damper to regulate air going to the burner.

A butterfly valve will fit within the burner pipe. Whether you decide to control, the air in the burner pipe or at the blower intake does not matter. We must construct it in a way that it provides positive action without moving of its own accord.

Building a wood fire should slowly dry the newly lined furnace inside and letting the wood burn down to coals. It takes about two days of this treatment to be safe.

For the first heat, put two thickness of cardboard on the crucible support block and place the crucible on the cardboard. With the furnace cover off, place the metal charge loosely in the crucible. Do not wedge the metal in it, as it must have room to expand without restriction. Wedging metal in a crucible can cause it to split.

## LIGHTING THE FURNACE

Now place a wad of burlap material dampened with fuel oil, about a foot from the burner port, in line with the firing direction. We should jam the lighter wad snugly between the support block and the furnace wall. This will prevent it from being blown out of the furnace or away from the burner. The wad has to remain in place, burning until the furnace wall reaches ignition temperature. Prepare to fire the burner by opening the blowers air control valve halfway. Light the wad and allow it to burn briskly. Turn on the blower and check to see if the wad is still burning briskly. Should it blow out, turn off the blower and start over. Once you have decided that the lighter wad will burn with the blower on, open the gas valve until you get ignition:

Adjust the gas to the point that produces maximum ignition, the loudest roar in the furnace. At this point, you have maximum combustion for the blowers output. Allow the furnace to run for five minutes at this setting. After five minutes have elapsed, the furnace wall should be hot enough to maintain combustion. Place the cover on the furnace, and advance gas intake and blower output to the point where the gas is wide open and we adjust the air for the maximum output of air, without blowing out the flame. Now advance the blower out put slightly. This will give you a slight oxidation in the furnace, the best condition for melting.

During the lighting up and the five-minute period with the cover off, keep your hand on the gas valve. Should you lose ignition during this period, close the gas valve at once, let the blower run a minute or two to clear the gas-air mixtures, then close down the blower and start over.

Never relight a furnace using a hot wall; always use a lighter wad. Never light a furnace without the blower delivering at least half its capacity. Too low a setting can result in a backfire into the blower. The blower has to be blowing hard enough to overcome backpressure so that the ignition takes place in the furnace. Do not light a furnace with the cover on for the same reason. Should the power fail and the blower stops, immediately turn off the gas, so never leave a furnace unattended during the melting process. To shut down the furnace, close the gas valve first, then the blower.

# THE ADVANCE KNIFE MAKERS MANUAL

## POURING THE MOLD

The actual pouring of molten metal into molds is a very important phase of the casting operation. More castings are lost due to faulty pouring than to any other single cause. Some basic rules for gravity casting a mold poured from a crucible or ladle.

1. Pour with the lip of the ladle or crucible as close to the pouring basin as possible.
2. Keep the pouring basin full (choked) during the entire pour.
3. Keep the pouring lip clean to avoid dirt or a double steam.
4. Use slightly more metal than you think you will need.
5. Pour on the hot side, for more castings are lost by pouring too cold rather than too hot.
6. Once a choke is started, do not reduce the stream of metal.
7. Do not dribble metal into the mold or interrupt the stream of metal.
8. If a mold cracks and the metal starts to run out, do not try to save it.
9. If a mold starts to spit metal from the pouring basin or vents, stop pouring.
10. Don't use weak or faulty tongs, or shanks.
11. Keep the pouring area clean and allow plenty of room for sure footing and maneuvering.
12. Do not pour with thin weak crucibles.
13. Wear a face shield and leggings.
14. When pouring at night, dust the pouring basin with wheat flour in a bag to make a more visible target for the pouring.

# THE ADVANCE KNIFE MAKERS MANUAL

## PLASTER CASTING

If you decide to make a few special items, especially if the part takes quite a while to make, you will find it much easier to cast the parts, and then finish it to proper size. Machining the parts takes many hours, and cast parts will save you many hours.

When you needed special parts for a rifle, pistol, knife, etc. you can probably make them out of brass or aluminum. I have had to restore old rifles; mostly muzzleloaders that had broken trigger guards or butt plates using the following methods. On making some parts, we can make the pattern in two pieces from wood. It would take too much time to machine or file out the needed parts.

When we needed a special part, I found some soft pine and whittled out the pattern that I needed to have. I then got some gypsum plaster and made a mold. The wood pattern was sanded smooth, and we put a coat of lacquer on it to seal the wood.

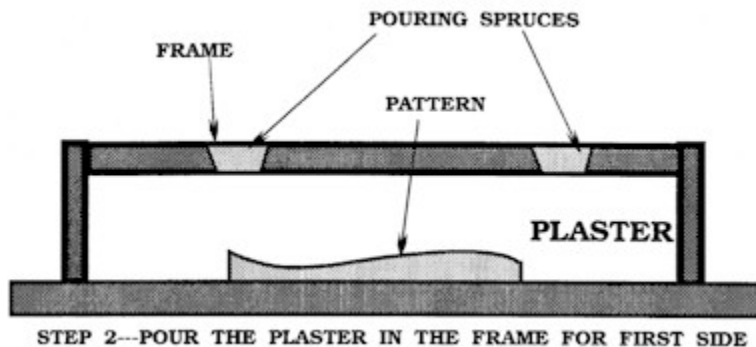

When the pattern was ready to use, I added a good coat of paste floor wax to it to guarantee it not sticking to the plaster. I poured some fine sand in a box, and then smooth it off, and then the pattern was pressed one half of its thickness into the sand. The patterns and parting surfaces are first sprayed with a suitable parting agent.

## PLASTIC SLURRY

After mixing the powder with about 60 per cent water by weight, we pour the plaster slurry into the flask, or surrounding frame, over the pattern. This should be done carefully to avoid the entrapment of air. Be sure that the pattern is just at 2 of its depth, as if it is too deep, or not deep enough, you will stick it in the mold. We then poured the plaster over the pattern, and in ten to thirty minutes, the plaster will become hardened. Then we must carefully remove the patterns with lateral rapping.

After it was set up, I removed it from the sand and removed all the sand. I carefully removed the pattern from the mold, taking care that we have not nicked the pattern. One method for removing a pattern is to blow compressed air through a small hole that leads to the separation surface between the plaster mold and the pattern. Later during pouring, the hole

## THE ADVANCE KNIFE MAKERS MANUAL

may serve as a vent for the escape of air.

We must then heat the mold halves in an oven at or about 400 degrees F (this temperature may range from 300 to 1500 degrees F) to drive off all free water and convert the gypsum again to CASO. This may require twenty or more hours.

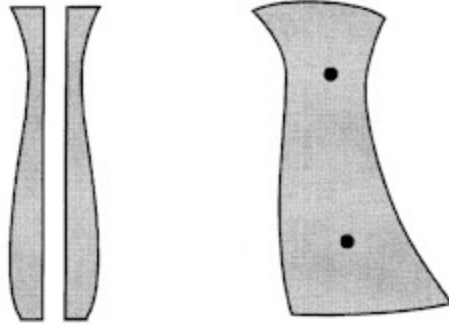

STEP 1--MAKE THE PATTERN OR USE A ORIGINAL

While the mold halves are still hot from the drying oven, we quickly assemble them, plaster cores are set if required, and we pour the mold. This is done without any delay to reduce the absorption of moisture from the surrounding air. Moisture must be kept at a minimum, because ordinary plaster molds have practically no permeability.

With plaster casting, producing castings with smoother surfaces and closer dimensional tolerance is possible. Small dimensions on one side of its parting line can be held, if required, too within tolerance of  $\pm 0.005$  inch. The molds are made of gypsum plaster, and they contain silica flour, silica sand, and other desired ingredients. Since water must not affect the patterns, I usually made them out of metal (Aluminum) when I had several parts to make.

There is a metal casting plaster available, which can be made permeable by whipping or mixing small air bubbles into the slurry with the use of a rapidly rotating, partially submerged disk or blade. Many small air bubbles thus formed become interconnected when the mold is dried, providing sufficient permeability. Small castings in nonferrous metals (aluminum, brass, bronze) can be produced in plaster molds with a surface finish as fine as .90 to .125 inch and an accuracy as close as 0.005 inch. On small dimensions with an additional 0.002 inch per inch on larger dimensions. From 0.005 to 0.015 inch, we usually require more across the parting line. Molds are made of a special plaster

### CORES

Cores, for holes and recesses, also can be made of the plaster composition. The size of the parts usually made in plaster molds ranges from a small fraction of an ounce to 10 lb. The plaster causes slower cooling of the casting than would occur in sand molds. This slowness has a tendency to improve the characteristics of bronze castings, but it is a disadvantage with aluminum, giving properties that are somewhat lower than those with sand or shell mold

## THE ADVANCE KNIFE MAKERS MANUAL

castings.

The pattern and the piece cost are much higher than for sand castings, but this cost is often justifiable because of the better finish and the elimination of machining. With these permeable plaster molds; eliminating the chemically combined water from the gypsum is not necessary, so drying requires less time.

One important application of plaster casting is the making of pressure cast fancy brass handles for pistols or knives, and frames for guns. In this application, the molten aluminum is first pored into a plaster lined, cylindrical metal receiver above the gate spruce

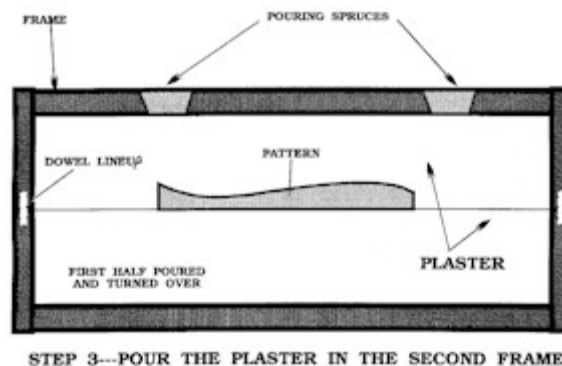

A sot asbestos disk about 1/16 inch, thick placed at the bottom prevents the metal from entering the sprue. When the metal is just beginning to solidify, we cover the metal receiver, and compressed air at or about 5 psi is admitted above it. This breaks the asbestos disk and forces the solidifying metal quickly into the mold cavity.

This casting procedure produces smooth surfaces, excellent detail, and a minimum of shrinkage. Because of the limited refractoriness of gypsum, plaster casting is limited to metals with pouring temperatures below 2150 degrees F. Since the heat conductivity of plaster is lower than that of molding sand, solidification of the castings will be slower.

We accomplish this without altering mold-cavity surface smoothness. Additional drying time may be necessary to drive off free water. We recommend the use of metal patterns, especially if we make more than one part. This process is well suited for intricately shaped castings, especially of aluminum, where dimensional accuracy and surface smoothness are the main concern.

A plumbers propane lead metal melting pot can be used to melt most alloys. If higher temperature is required, you will need to make up a forge to melt the metal in. If we need much casting, a forge will speed up the casting.

A split metal pattern is used, mounted on plates and so designed that we that can remove it

## THE ADVANCE KNIFE MAKERS MANUAL

in two halves from the mold. We pour around this pattern and allow the plaster to harden.

Then we remove the pattern, and the two halves of the mold are baked in an oven to harden them further, and to dry out all the moisture.

The nonferrous metals predominantly used for casting are alloys of copper, brass and bronze. Brass is generally identified by its color, and is said to be either red or yellow; color can serve as an indication of the temperature required for the melt.

### FLUXES

When we melt a copper-based metal in a crucible, some of the metal will combine with oxygen to form cuprous oxide. To convert the cuprous oxide back to metallic copper, something has to be added to the melt to draw the oxygen. The one most commonly used for red metals is phosphor-copper: an alloy of copper and phosphorous. Phosphorous has such an affinity for oxygen that it will ignite upon exposure to air: to make it stable enough to use, we alloy it with copper in the form of "shot." When introduced into the molten metal, the copper melts and releases the phosphorous, which deoxidizes the cuprous oxide in the melt.

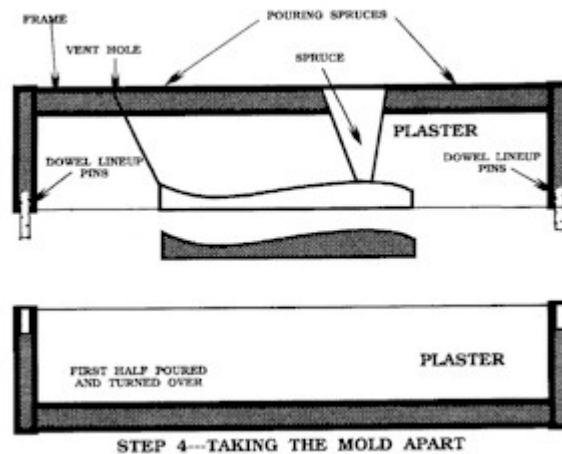

Nitrogen can carry out oxygen of a melt; we introduce the nitrogen gas (dry) through a hollow tube called a lance, which a rubber hose connects it to the gas cylinder. For red metals, the lance is carbon; for aluminum, it is iron or steel. We insert the tube into the molten metal too within an inch or so of the bottom of the crucible.

A very good deoxidizer for copper is 5 ounces of black calcium boride powder. It is sealed in a copper tube 2 inches long, with the ends crimped closed. The best flux for melting down extremely fine scrap pieces such as buffing or grindings is plaster of Paris.



## THE ADVANCE KNIFE MAKERS MANUAL

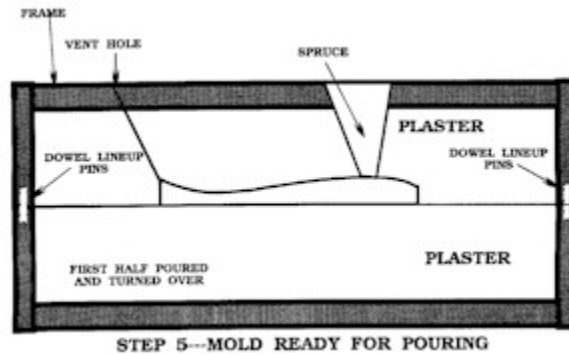

There is another group of fluxes used to prevent the gases in the furnace from being exposed to the molten metal and oxidizing it. Because they are used as a protective cover, they call them cover fluxes. This flux is made by mixing five parts ground marble with three parts sharp sand, one part borax, one part salt and ten parts charcoal. Another one, Mix equal parts of charcoal and zinc oxide, add enough molasses water to form a thick paste; roll the paste into 2 inch balls and let them dry. When the alloy starts to melt, drop in enough balls to cover the surface.

Some fluxes are very detrimental to refractory linings, often eating away a ring around the inside of a crucible during a single heating. Check with your crucible and flux supplier to find out what is compatible before using a particular flux.

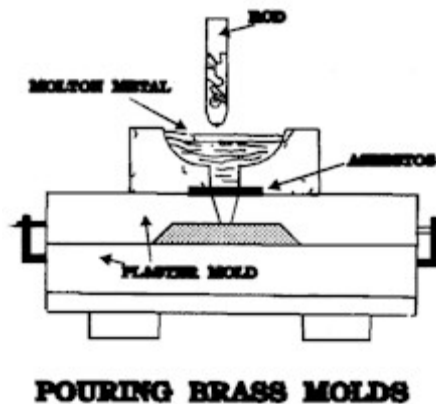

### RED BRASS

Leaded red brass can be used with a simple gating system but it must be choked because these alloys flow quite freely. We require risers for heavy casting sections, and the melt must be fast (under oxidizing temperatures). No cover flux is necessary for these alloys, especially when clean materials are used. Deoxidize with 1 ounce of 15 percent phosphor-copper, for each 100 pounds of melt. Too much deoxidizer will make the metal too fluid, and can result in dirty castings.

The average composition of red brass is: 85 percent copper, 5 percent tin, 5 percent Ann

## THE ADVANCE KNIFE MAKERS MANUAL

and 5 percent lead; they call this alloy eighty-five and three fives or ounce metal". They handle semi-red brass like red brass. Its composition is normally 78 percent copper, 2.5 percent tin, 6 percent Lead, and 7 percent zinc.

The pouring temperature range for this alloy is 1950 degrees Fahrenheit for very heavy sections, to 2250 degrees Fahrenheit for very thin sections. Generally, 2150 degrees Fahrenheit can be considered as an average pouring temperature.

Using leaded yellow brass requires gating similar to that used for red brass, with the exception that the sprue, gates, and runners must be somewhat larger. We must fill the mold cavity as rapidly as possible. If filled too slowly, the zinc in the alloy will produce a wormy surface on the casting. If melted in an open flame furnace, such as a rotary or reverberatory type, high zinc loss will result. Crucible melting is best for yellow brass.

The general pouring temperature is 2050 degrees Fahrenheit. We require no cover flux, but we should deoxidize the metal with 2 ounces of aluminum per 100 pounds of melt. (Never use aluminum and phosphor copper together.)

To prevent zinc from condensing in the mold cavity, the cause of the surface condition described, tip the mold so the sprue is at the low end of the mold.

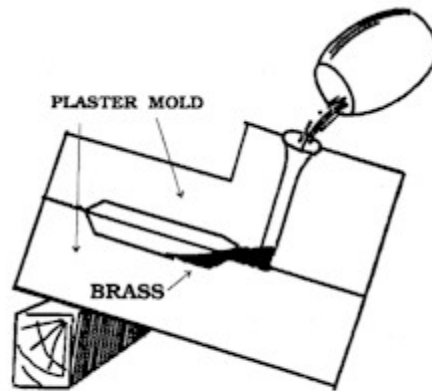

**USING BRASS MOLD**

The normal composition of yellow brass is 74 percent copper, 2 percent tin, 3.5 percent manganese and 20.5 percent zinc. High-strength leaded yellow brass (manganese-bronze) is characterized by high shrinkage, and the tendency to form dross (oxides) during pouring, or when agitated. We prefer bottom horn gating, and large risers and chills must be used. It is a tough metal to cast and requires considerable experience. We melt in crucibles and pour it at the highest possible temperature to prevent the excessive production of zinc fumes.

They also recommend that high temperatures reduce the risk of flaring, flames shooting up from the surface of the molten metal.

# THE ADVANCE KNIFE MAKERS MANUAL

Yellow brass will flare at about 185 degrees Fahrenheit. Approximately 155 pounds of zinc will be lost for every 100 pounds of alloy melted, and we must replace this.

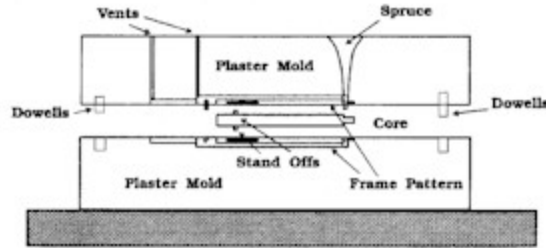

PLASTER MOLD SPLIT SHOWING PATTERNS AND CORE

## ALUMINUM ALLOYS

They melt aluminum alloys and they are handled much the same as copper-based alloys. They have, however, a high rate of shrinkage during solidification, we must pay attention to correct risering to prevent this. It is common to increase the strength of aluminum casting by as much as fifty to one hundred percent by redesigning or moving the gates and risers.

Cores must be low in dry strength and high in permeability. The pouring temperature range is usually between 1250 and 1500 degrees Fahrenheit. Deoxidizing is done with solid fluxes, or by bubbling nitrogen through the molten metal. We melt aluminum in crucibles, cast-iron pots, and in open flame furnaces.

## CASTING A PATTERN IN PLASTER

This is a simple method to cast a few small parts in plaster. We will use a simple project like a grip on a revolver as a starting point, but a pistol frame is done the same way. The frame must measure 5 1/2"x 3 1/2 x 2 inch high. We mount it on a piece of glass that has first been rubbed with liquid soap or Vaseline. We then fill it slightly less than half-full with a thick paste of plaster of Paris.

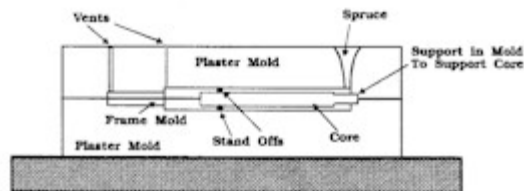

PLASTER MOLD READY FOR CASTING WITH CORE IN PLACE

To make the plaster harder, add a pinch of alum or some water glass. Use cold water for mixing warm plaster hardens too quickly. After the paste has been thoroughly smoothed with a spatula, wait two minutes until the plaster has started to dry. Press the grip, sideways on,

## THE ADVANCE KNIFE MAKERS MANUAL

halfway into the plaster, having previously coated it thinly with Vaseline or salad oil.

Be careful not to coat the fine detail too thickly, otherwise this detail will be missing from the mold. Make sure the model is pressed in only as far as the halfway mark to get no undercut forms in either half of the mold. Bits of plaster forced up around the edges or into the hollow parts of the model as it is pressed in, must be carefully scraped away with a small knife, after the plaster has hardened.

When we introduce the grip, a piece of doweling is pressed into the plaster to form a pouring channel leading to the mold. This should run obliquely from the top of the frame to the base of the figure so the mouth of the channel lies as low as possible. A second, thinner piece of doweling should run vertically upwards from the top of the grip, later, during casting, air can escape through this outlet. We must also coat these two pieces of doweling with grease so the plaster does not stick to them. Before the plaster has completely dried, make four conical holes in the surface of the half-mold with a blunt pencil.

When these are quite dry, carefully rub them smooth with a pumice stone. The lower half of the mold is now complete. We brush with graphite or wiped its surface and the four holes with Vaseline to separate them from the plaster of the upper half. For the latter, we use much thinner plaster that we should pour on gently from the side and allow to it cover the grip slowly and gradually.

### AIR BUBBLES

Be careful to prevent the smallest air bubble from forming in the plaster. Once the grip is covered with a thin layer of plaster, stop pouring for a moment. Then fill the frame to the top. Let the whole mold stand overnight so that the plaster can set properly, remove the surrounding frame, and separate the two halves of the mold, using a knife blade to remove the pieces of doweling.

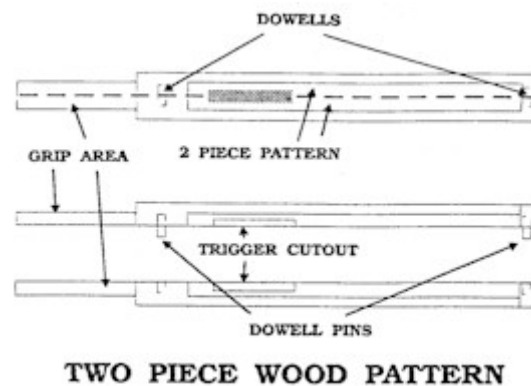

This is why we made the four conical holes in the lower half of the mold. The upper half has pegs that fit into these holes and ensure the exact matching of the two halves. After taking out the model, remove any surplus plaster from the mold, clean out the mouths of the two channels, and develop the upper opening of the pouring channel into a funnel shape.

## THE ADVANCE KNIFE MAKERS MANUAL

After a week of drying (we will not use heat on the first one), the mold is ready for use. It is sufficient to smear it lightly with soot before casting and to press both halves firmly together while pouring in the molten metal. We heat, but not overheated the metal, in a cast iron ladle.

The mold may break at the first or second casting because of cavities due to small air bubbles just beneath the surface, the walls of which are burst by the hot metal. However, a carefully made mold can give some twenty castings before the edges begin to crumble, rendering the mold unusable.

### MAKING A MOLD OF A ONE PIECE PATTERN

The first step in making a mold on the bench is to place the pattern with the parting surface downward on the molding board. Tempering the sand means to add moisture so it will pack.

Sprinkle the sand uniformly with water, and thoroughly mix with a shovel or trowel. Test for the proper moisture content as follows:

Make a lump of sand by squeezing a handful together in the hand. Break the lump into parts with the fingers, and if the edges at the breaks are firm and sharp, the sand is ready for use.

The pattern is checked to see that the draft is pointing upward so, when we turn the flask, we may remove the pattern without breaking the mold.

The drag half of the flask is placed on the molding board with the pins pointing downward. Place the pattern centrally on them old board with the largest dimensions down. A pattern must have draft (be tapered) so it can be withdrawn from the sand.

### SET UP THE DRAG

The drag is the half of the flask used for the bottom half of the mold. Select either half of the flask for this purpose. In either case, place the drag down on the moldboard and over the pattern with the pins or the sockets down.

### POURING THE MOLD

The actual pouring of molten metal into molds is a very important phase of the casting operation. More castings are lost due to faulty pouring than to any other single cause. Some basic rules for gravity casting a mold poured from a crucible or ladle is:

1. Pour with the lip of the ladle or crucible as close to the pouring basin as possible.
2. Keep the pouring basin full (choked) during the entire pour.
3. Keep the pouring lip clean to avoid dirt or a double stream.

## THE ADVANCE KNIFE MAKERS MANUAL

4. Use slightly more metal than you think you will need.
5. Pour on the hot side, more castings are lost by pouring too cold rather than too hot.
6. Once a pour is started, do not reduce the stream of metal.
7. Do not dribble metal into the mold or interrupt the stream of metal.
8. If a mold cracks and the metal starts to run out, don't try to save it.
9. If a mold starts to spit metal from the pouring basin or vents, stop pouring.
10. Wear a face shield and leggings.
11. When pouring several molds in a row with a hand shank, start at one end and backup as you go. Going forward to pour brings the knuckles of the hand closest to the ladle over the mold just poured.
12. When pouring several molds from a single ladle or crucible, pour light, thin castings first (the metal is getting colder by the minute).

If the metal in the ladle or crucible is not bright, clean, clear, and hot, do not pour it.

# THE ADVANCE KNIFE MAKERS MANUAL

## RUBBER MOLDS

This method of making molds for duplicate wax patterns is quite simple, requiring no elaborate equipment, processing or heat treating (vulcanizing). The original pattern may be made of any convenient material such as wood, metals, or plastic, anything except wax. The pattern, of course, must have a sprue attached so that we mold a pouring orifice into the mold.

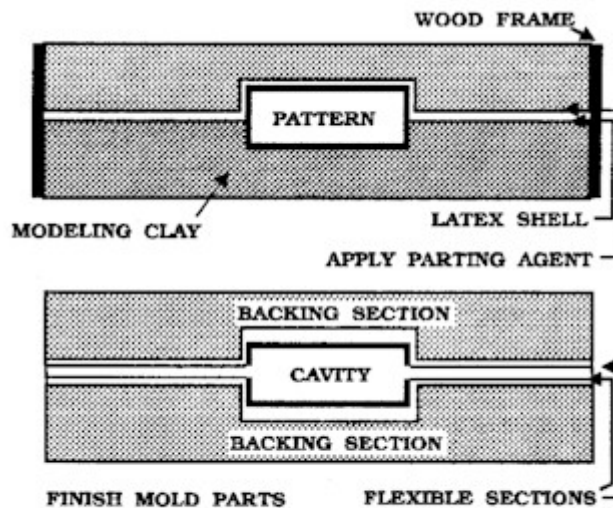

## LATEX MOLD

They call the mold material Pure Rubber Brushing Latex and is obtainable in many art supply, hobby, and plastic supply shops.

You will find that with the lost wax method, or investment casting you can make just about any type of part or frame. Even if it has many under cuts, holes, etc. you can still cast the finish part. To be able to get a perfect casting, you will need a pressure machine described in the following chapter.

There are many high strength materials on the market today that will probably meet your needs. Investment casting can be used to cast the actions, parts, and complete knife handles. All of this can be done with investment casting, and the information given in these chapters will start you on your way.

## MAKING THE MOLD

Embed the pattern to its halfway point in a block of modeling clay having a flat surface. This block of clay should be about three Inches Square, larger for larger patterns. Surround it with a wooden form extending about d inch above the pattern. Grease the inner surfaces of the wood form with Vaseline. Now coat the entire surface of the pattern and the block of clay

## THE ADVANCE KNIFE MAKERS MANUAL

with four or five coats of the latex. Apply it with a brush. Drying time for each coat ranges from a half hour at elevated temperature, (about 100 degrees F.) to two hours at room temperature.

When all coats are set, and tack-free, brush on two coats of a parting agent, such as silicone, and let it dry. Next fill the area within the wood frame with latex loaded with a very fine sawdust or some similar filler, brushing in successive coats that are no thicker than c inch. Thicker coats will take too long to cure. We should mix the Loaded latex as used as any that is left over will cure before you are ready for the next coat.

The brush will wash out readily if washed immediately after each coat in running water. They may mix the loaded latex in any cup or glass, as it will not adhere.

### MAKING THE SECOND MOLD

When we have completely cured the first half, remove the modeling clay, and invert the whole in the wood frame so that the loaded latex section is now at the bottom. The upper surface, now exposed, is that which was against the clay, with half the pattern exposed. Now coat this entire surface with parting agent and repeat the above process.

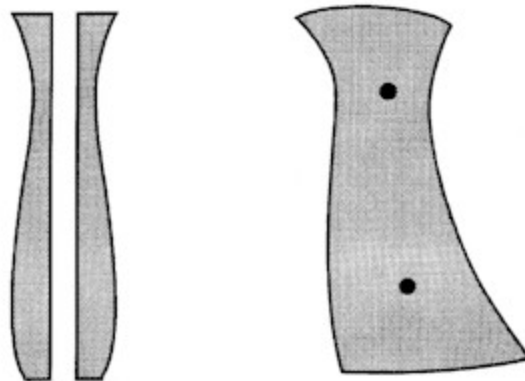

STEP 1--PREPAIRING THE PATTERN

The several coats of pure latex.

The coats of loaded latex. Be sure to apply the coats of parting agent between the two operations.

If properly prepared, the mold will part readily for the removal of the pattern, and the loaded sections will part from the thinner, pure latex, mold sections. The wooden frame will serve as a guide for reassembling the mold parts.

You now have a four-part mold. The two thin sections are sufficiently flexible to allow the removal of the wax patterns regardless of any undercuts. The firmer sections, made of loaded latex, will be sufficiently firm to back up the thinner sections and hold them in place.



## THE ADVANCE KNIFE MAKERS MANUAL

We may make the thin sections thicker or thinner as experience dictates, depending on the intricacies of the original pattern.

We must make provision in the wood frame to match the sprue opening for pouring the wax. This mold will stand warming to the temperature necessary to allow the wax to flow freely. It may sometimes be advisable to prepare for clamping the mold together with C clamps.

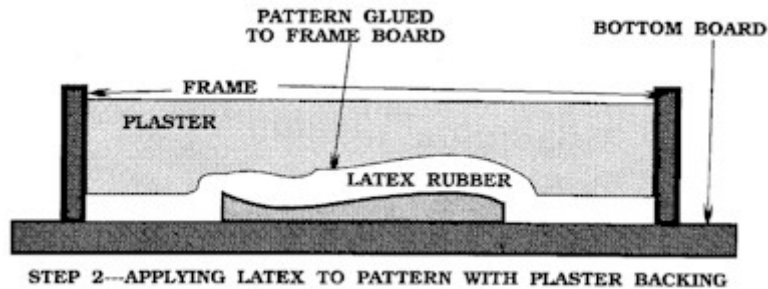

Latex is not a rubber cement, although for certain applications it does a good job, especially for temporary bonding to glass, such as wooden frames to contain plaster for intarsia. It is a liquid latex formulated for air curing. It is very commonly used for ceramic molds. While molds made in this manner lack the durability of vulcanized rubber, they are sufficiently durable for most purposes. Latex molds have a shelf life of about two years before deterioration sets in.

The secret of using this system is in working out the optimum thickness of the shell section in relation to the particular pattern to be reproduced. The more intricate the pattern as for undercuts, the thinner the shell should be. However, the thinner the shell, the more difficult it is to assemble the mold.

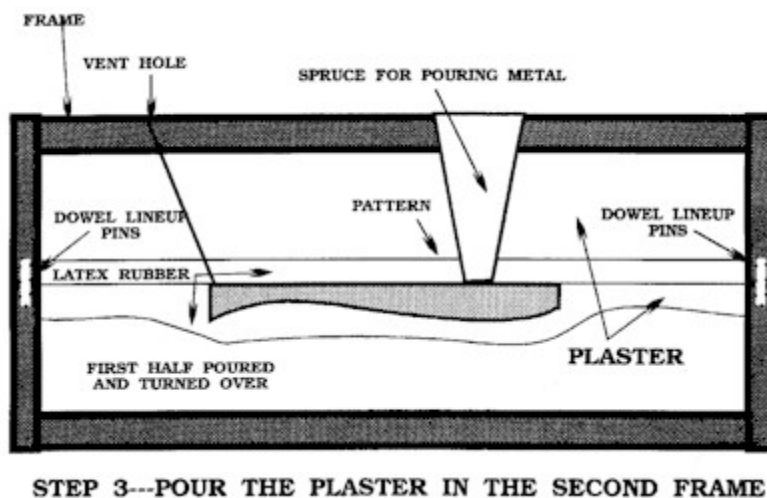

Any liquid or jellied parting agent containing silicone can be used to coat the sections. Ceramic or Art shops can supply this. The use of talc is not advisable since we must brush the latex on and this could disturb the powder and cancel its purpose.

## THE ADVANCE KNIFE MAKERS MANUAL

The latex has also been used as an electrical insulator. However, remember that it will loosen in contact with moisture and it is definitely NOT oil resistant. It is completely soluble in most light hydrocarbons such as gasoline, naphtha, benzine, xylol and similar solvents.

# THE ADVANCE KNIFE MAKERS MANUAL

## CASTING OBJECTS IN PLASTIC

Casting is a process in which a liquid plastic is poured into a mold. The plastic is a liquid resin to which a catalyst is added before pouring. The molds range from complicated to simple home workshop types. Molds used in casting processes are usually inexpensive and are made from materials such as plaster, glass, wood, metal, and other plastics.

Resins can be cast cold or hot and allowed to solidify through further polymerization with heat added if necessary. Exothermic heat is generated by a chemical reaction. A catalyst is used to start the chemical reaction. Heat from an outside source is called endothermic.

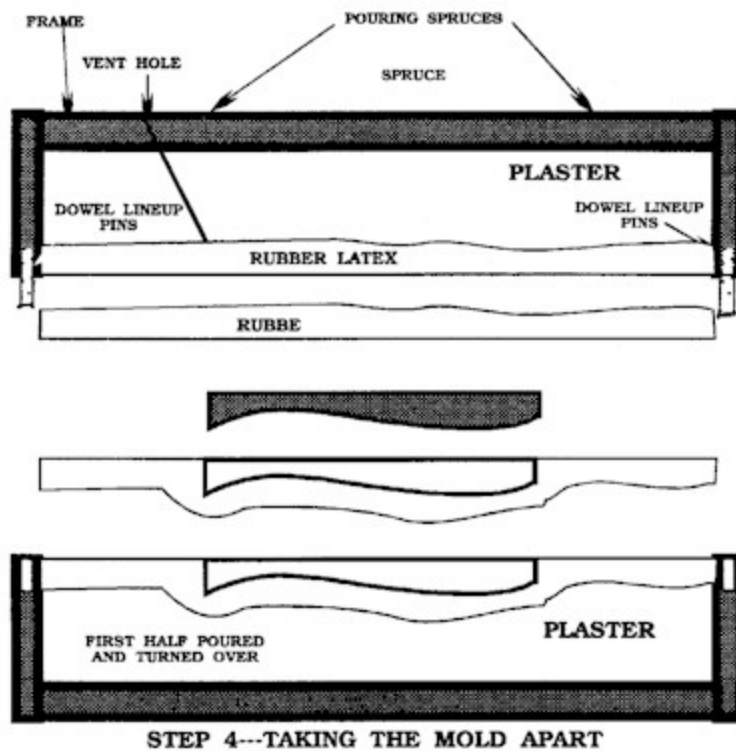

The advantage of casting parts is that the molds are inexpensive. They can be made from silicone, glass, cement, cast metal, and plastic. Very little pressure is used in casting. The only equipment needed is a mixing machine and an oven. Products with a very thick section are easier to cast than mold by other processes.

Many large and small parts are cast, and brush back handles, cutlery handles, and screwdriver handles can be cast. Acrylics, polyesters, plasticols, and epoxies are the most common plastics that are cast. Common casting resins are the acrylics, polyesters, nylons, silicones, epoxies, phenolics, and polyurethanes. Resins are often filled for reinforcement. They are available from clear too opaque and may be colored to any desired shade.

## POLYESTER CASTING

## THE ADVANCE KNIFE MAKERS MANUAL

Polyester resin is a common plastic that is cast, and it is an inexpensive resin. It can be cast clear or be colored. The resin is mixed with a catalyst, usually MEK (methyl-ethylketone peroxide). The amount of catalyst used is dependent on the thickness of the part. Resin manufacturers will give complete instructions on how much catalyst to use.

Generally, if the casting is up to 1/8" inch thick, 10 drops of catalyst per ounce of resin can be used. For castings up to 1/4 inch 8 drops are used, and for castings up to 1/2", 6 drops per ounce of resin are used. Very thick sections over 1/2 inch require about 2 drops per ounce of resin. If too much catalyst is used, the casting may cure too fast, trapping air bubbles. The casting will shrink and may crack. Not enough catalyst will result in a casting that will not cure properly. The exothermic heat produced from the chemical reaction is about 300 ° F (150 ° C).

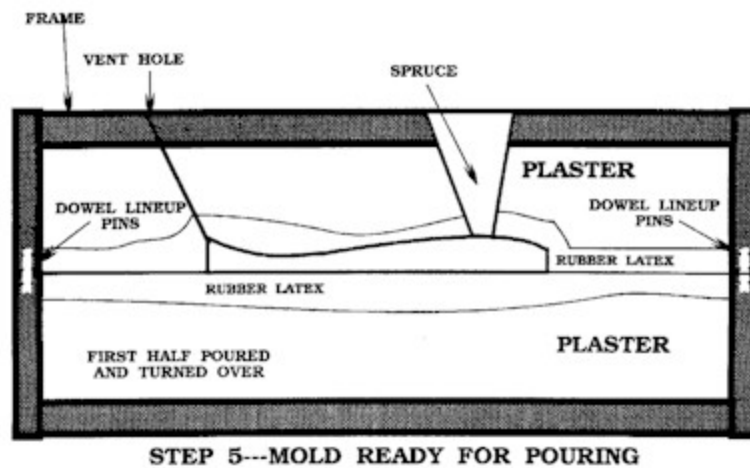

The polyesters are used for embedding items, hobby work, cast parts, gun parts and knife handles. Epoxy casting resins are sometimes filled with metal powder are used for making molds, tooling jigs, and dies. The flexibility of silicone resins has made them ideal for casting molds into which other resins are cast.

### CASTING PROCESSES

One of the major casting processes that of producing cast acrylic sheet, is done by using a premixed acrylic liquid in the form of a thick syrup. The liquid is poured between two sheets of polished glass and allowed to cure. After casting, the sheets are heated to relieve any stresses, cut to size, and paper coated to protect the polished surfaces. A process similar to this is used for casting acrylic rod.

### ENCAPSULATION

# THE ADVANCE KNIFE MAKERS MANUAL

Encapsulation is similar to casting and it is used to completely enclose an object in plastic. Polyesters, acrylics, and epoxies are used for encapsulating. Embedding is the encapsulating of an object for preservation and display. Stamps, coins, and biological specimens are frequently embedded in plastic and acrylics and polyesters are usually used for this type of embedding.

Polyesters for embedding are usually cast in two layers. After the first layer has jelled or cured, the embedment is placed in the mold. The second layer of resin and catalyst is mixed and poured into the mold. Most of the other mold materials will require a mold release with the exception of rubber or silicone.

Nylon is an important casting material because of its high strength and wear resistance. The nylon liquid is cast into one or two-piece molds and cures into the polymer. Size and thickness are limited only by the size of the mold. Mold costs are low for cast parts, making short runs feasible.

## PLASTISOL CASTING

Plasticols can be cast in an open metal mold. Endothermic heat from an oven is used to cure the plastisol. The plastisol is not cured as in polyester resins. The heat drives off some of the plasticizer. The rest of the plasticizer combines with the vinyl particles. The mold is filled and placed into an oven at 375° F (190 ° C).

The time in the oven is dependent on the thickness. A 1/8-inch thick casting will require about 8 to 10 minutes. Twenty minutes might be needed for a casting that is 1/4inchthick. Toy insects, fishing lures, and bottle stoppers and many different types of objects can be cast.

## MAKING MOLDS

Silicone resins are used extensively for making molds into which other plastics may be cast. The property of silicone as a mold material includes flexibility for easy part removal and exacting reproduction of detail. No mold release is required for part ejection. Lead may even be cast into a silicone mold since it is resistant to temperatures up to 600° F.

The preparation of a silicone mold begins with the construction of a pattern. The pattern is fastened to the base of a mold frame and coated with mold release. The silicone resins and catalyst are weighed in proportional amounts and mixed together. Bubbles caused by mixing are usually removed using a vacuum jar. Then, the resin is carefully poured over the pattern to avoid trapping air bubbles.

When the mold frame has been completely filled with silicone, a cover is placed over the mold to produce a flat surface. After a 24-hour curing period, the back plate is removed and the pattern is stripped from the mold. The finished mold is now ready for casting with any number of different liquid resins. Parts that are cast in silicone molds may be pigmented

## THE ADVANCE KNIFE MAKERS MANUAL

internally or painted. Silicone molds used for casting have an average life of 100 to 200 molding cycles.

## EMBEDDING OBJECTS

Embedding objects in plastics is accomplished with a smooth surfaced mold and a clear acrylic or polyester resin. This is done in two steps casting process. A catalyzed layer of plastic is poured into the mold and allowed to cure. Then, the object to be embedded is placed on the partially cured surface. The second layer is poured into the mold, surrounding the object and bonding with the first layer. Plastic embedments are used for clear display of valuable items and for the preservation of biological specimens.

## CASTING IN MOLDS

When casting in the plastics molds, thermosetting resins, the polyesters, silicones and epoxies are generally used. Plasticols (mixtures of polyvinyl chloride and liquid curing agents) may also be cast.

Most casting materials consist of a resin base to which a catalyst is added to cause final polymerization or hardening. The basic steps are:

1. Getting the mold ready.
2. Pouring the resin.
3. Removal of the part from the mold.

Molds can be made of many materials including wood, glass, polyethylene, silicone and a number of metals. A mold release such as a good wax is generally used to make easy removal of the product.

Polyester and epoxy casting resins are similar. They are obtained as a clear resin base to which a clear catalyst is added. The basic casting steps are as follows:

1. Get a suitable mold and apply a thin coating of mold release to the inside surfaces.
2. Pour into a measuring cup the correct amount of resin to completely fill the mold and add the amount of catalyst as specified by the manufacturer.
3. The mixture should be stirred slowly for a few minutes being careful not to stir air bubbles into the resin. If color or some type of fill is needed you add it now.
4. The resin mixture is then poured slowly into the mold to the correct level. Inexpensive glass molds in various sizes are available from plastics supply houses.
5. Upon curing, which takes from 2 to 6 hours depending upon the amount of catalyst used,

## THE ADVANCE KNIFE MAKERS MANUAL

the part is removed from the mold.

6. Final finishing can be accomplished by filing and buffing with a polishing wheel, however most items can be used as cast.



## CASTING PARTS

The general procedure described is used with all casting resins and molds with slight variations. The silicone resins are useful in the shops for casting molds for short production or intricate cast plastic products. This process involves two casting sequences.

A pattern made of wood; plastic, metal or other material is placed on a mold plate. A small amount of contact cement is used to keep the pattern in place. The mold frame is placed around the pattern with paste wax on the edges to keep the poured resin from leaking out.

The amount of catalyst specified by the manufacturer is added to the silicone resin and the mixture is stirred slowly. Slow mixing will avoid trapping air bubbles in the resin. The silicone resin is slowly poured into the mold starting at one edge, allowing the resin to cover the pattern until the mold is full. When the silicone mold has cured, the pattern is removed.

A casting resin is then prepared, as has previously been described, and poured into the silicone mold until the mold is full. The resin is allowed to cure and is removed from the mold in the same manner the pattern was removed. The edges of the casting are filed smooth, buffed, and the product completed.

Castings can be embedded with different objects are made by pouring the resin to the desired level and gently placing the specimen on the resin surface. Knife handles can be cast in one piece on the finish knife. The remainder of the resin is then gently poured over the specimen being careful not to trap air bubbles. If the specimen is too heavy, the two layer casting process can be used.

## WAX PATTERNS

Despite the origin of casting, the practice has evolved and refinement has brought it to its present state. With today's terminology, castings are possible within tolerances of one thousandth of an inch or closer. Not generally known is the fact that your dentist is a master craftsman in the casting art. Industry uses investment-casting techniques to produce many intricate mechanical parts that, without these processes, would require extensive machining at high cost.

Although the casting methods outlined here are simple adaptations, the basic principles of casting remain. Because of these simplified methods and the availability of the material, investment casting can become a most interesting and productive business. Using self-made tools and equipment, we can achieve satisfactory casting results.

The prime area of investment casting to be covered is the casting of parts for firearms. You can use investment casting for other applications such as making small parts and fittings also. Casting, as with other forms of art, requires a knowledge of the basic step-by-step procedures to produce the desired results.

The technique described here involves the use of a self-made pressure-casting machine. Although centrifugal casting is more popular, the centrifugal machine is more complex, expensive and difficult to use. Pressure casting, besides its simplicity, need not be as elaborately safety guarded as a centrifugal machine. Also, pressure casting, has an inherent safety factor, as there is little risk of spilling molten metal. They create the metal directly in the flask cavity, poured directly into the pressure machine and then forced into the mold by air pressure. Centrifugal casting requires that the molten metal revolve at high speed to attain the needed casting pressure.

## PRESSURE CASTING MACHINE

The necessary pressure needed to get finished size castings, must be done by one of several methods. I will describe the method that I believe will be the easiest and best suitable for the small shop, which is the use of air pressure.

The initial pressure necessary to force the molten metal into the cavity is five pounds. The metal should flow into the cavity without turbulence to prevent air from entering the cavity ahead of the metal.

After about five seconds at five pounds of pressure, they turn up the pressure to 20 to 40 pounds, depending on the density needed in the metal. This pressure is what makes a perfect casting, with no shrinkage, and fills out all the holes, undercuts, etc.

On my pressure machine I used square steel tubing for the frame. We weld the handle where there are no air leaks, and has an air pressure gauge mounted to it. On the far end we mount

## THE ADVANCE KNIFE MAKERS MANUAL

an air hose coupler so an air hose can be snapped into place.

Under the lever where we mount the pressure cap, there is a 1/8-inch coupler welded to the lever and we mount the pressure plate to this. The pressure plate is a circular piece of aluminum 1/4 to 3/8 inch thick, one inch larger than the size of the flask. You will need several of these to fit the different sizes of flasks. We drill and tapped it for 1/8 N. P.T. pipe thread.

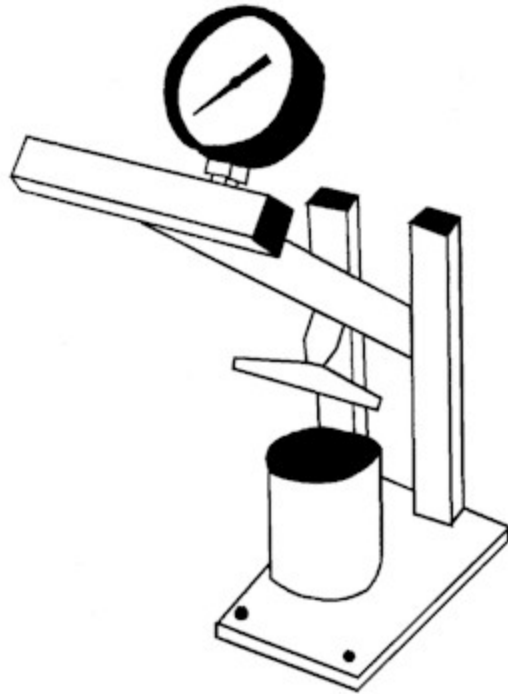

**Pressure Casting Machine**

To this piece affix a good adhesive such as silicone for automobile engine gaskets, three layers of sheet asbestos cut to size. This will seal the air pressure on the flask. We drill several holes in the up rights where we mount the lever. When you make the flasks, we should make them a certain height so the pressure plate will come down flat and seal it.

The flasks for pressure castings can be from any suitable tubing strong enough to withstand the pressure. After we invest the part, we make a reamer that will ream part of the top of the casting from the flask. This is done so the molten metal will flow directly into the mold. After the investment is set, we make a radius reamer, which can be any type of sheet metal or thin gauge metal, and we attach a rod to it for a drill.

The process also involves the use of other homemade equipment. We will start from the very beginning, which is the preparation of wax for a pattern and going through with each step necessary to complete a successful casting.

### MAKING A WAX PATTERN

## THE ADVANCE KNIFE MAKERS MANUAL

On larger parts, you will make the pattern from wood or aluminum. If you use wood it will need to be sealed so moisture cannot penetrate it. The finish needs to be flawless, as the finish castings will show all the marks that you have left on the surface. Making the finish part and then make a mold for it is best so you can make the wax patterns. By using investment castings and the pressure machine, you will not have to worry about shrinkage that you would have with sand or plaster castings. The finish part would be finished as it comes from the mold.

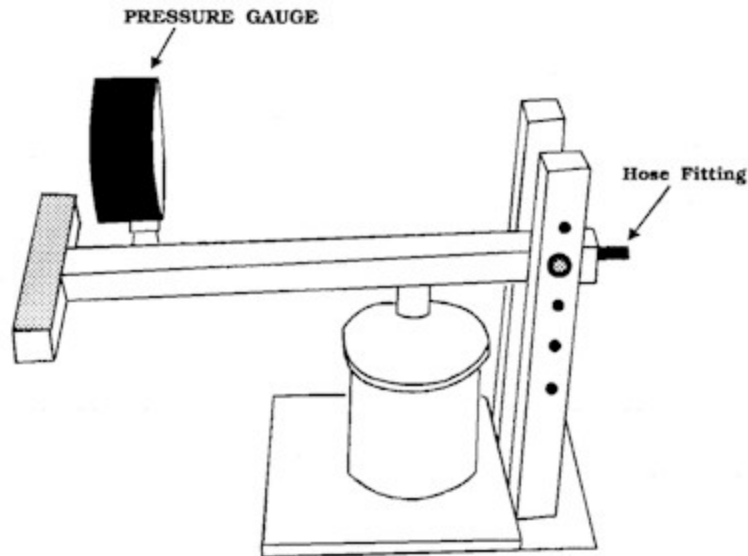

**Side View Of Pressure Casting Machine**

Besides, various wax wire shapes and sheet waxes, there are many other forms. Among these are hard carving wax, this wax yields readily to files and knives and can be sculptured into the most intricate designs and patterns. Also available is a sticky wax, and this can be used to fasten the various shapes together.

The sprue piece must be fixed to the pattern. Holding the sprue wire in intimate contact with the pattern and fusing the two pieces together. We can apply the heat to the joint with a pointed probe that we have heated over a flame. Be sure that the wax sprue wire is securely fused to the pattern to prevent subsequent loosening.

If you have an unusually large wax pattern, multiple spruces may be necessary. Note that each sprue ends at the center of the circular bottom plate and there is a space between each sprue. This technique can also be used if more than one wax pattern is cast at one time. Instead of the one large wax pattern, each individual sprue could hold one ring.

In this manner it is possible, depending on the size of the flask, to cast up to four or more

# THE ADVANCE KNIFE MAKERS MANUAL

rings or small patterns at one time.

## INVESTING WAX PATTERNS

To reduce surface tension on the wax pattern and sprue, we must paint a debubbler over all the surfaces. Commercial debubblers are available. Equal parts of tincture of green soap and hydrogen peroxide make a very good debubbler. Flow on an ample coat of debubbler, making sure it wets all corners and undercuts. Set the spruced pattern aside and permit the debubbler to dry thoroughly.

When the debubbler has dried, rinse the pattern in a beaker of clean water. Observe the pattern to be sure the water wets all surfaces. If the water forms small globules on the surface of the pattern, repeat the debubbling procedure. Again permit the pattern to dry thoroughly, rinse, and inspect. If we have not rinsed most of the debubbler from the pattern, an excessively heavy oxide will result on the finished casting.

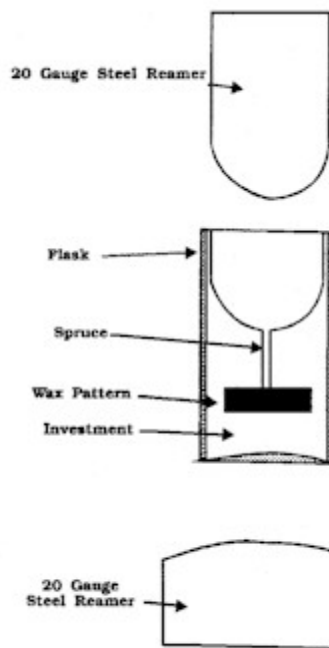

**CROSS SECTION OF FLASK**

Many flasks should be prepared in anticipation of the various patterns that may be cast. We can make the flasks from either brass or stainless steel tubing. Cutting several tubes approximately 2 inches in height. A good supply of flasks would range from 2 to 4 inches in height. The diameter of the flasks should vary according to the size of the casting that you need.

Select a flask at least 1/4 to 1/2 inch larger in diameter than the overall width of the wax pattern. The flask should be from 3/16 to 5/16 inch higher than the spruced pattern. A sufficient amount of investment should cover the pattern to prevent the molten metal from

## THE ADVANCE KNIFE MAKERS MANUAL

breaking through the bottom when the metal is cast. This thickness should not be so great, however, as to prevent the free passage of gasses through the bottom of the invested flask.

Next cut strips of sheet asbestos approximately 3 inch less than the height of the flask. Form these pieces over the outside of the flask to give them curvature. Insert enough pieces into the flask to cover the inside. A small amount of overlapping is permissible. We need the asbestos to absorb expansion of the investment during burnout. We should center the pieces with relation to the height of the flask. The exposed areas, both top and bottom, with no asbestos covering, will act as locks to retain the investment within the flask when we remove the flask from the burnout oven and transported to the casting machine.

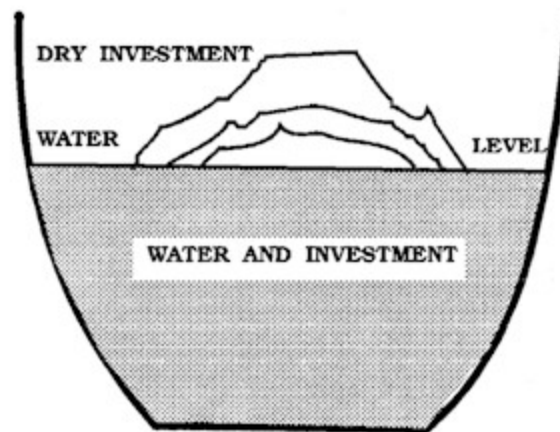

### MIXING INVESTMENT

Dip the asbestos-lined flask into a beaker of water. Wetting the asbestos is necessary to prevent excessive absorption of water from the investment. After we have dipped the flask, iron out with the index finger any air bubbles under the asbestos. Set the flask aside and permit any excess water to drain.

Place the asbestos Lined flask over the spruced pattern. Center it with relation to the wax pattern. We can hold the flask in place with a small quantity of sticky wax around the bottom at the junction of the flask and base.

### MIXING THE INVESTMENT

The next step is to mix the investment. If your flask is 1" inches high and 1" inches in diameter, measure out about one ounce of water at room temperature. Place the water into the mixing bowl. With a spatula, sprinkle the dry investment on the water. Sprinkle on only small amounts of the investment at a time. At first the water will absorb the investment and it will sink to the bottom. Eventually the dry investment will begin to build on top of the water.

If the pattern is intricate and detailed, we will need a thin mixture of investment. If the pattern is bulky, we will require a thicker investment. Although a thinner investment will more readily

## THE ADVANCE KNIFE MAKERS MANUAL

conform to an intricate pattern, it is inherently weaker. No hard-and-fast rule can be used to determine the consistency. Begin with a consistency approximately that of a pancake mixture.

Next, mix the dry investment by hand to produce a homogeneous mixture. The dry investment will tend to adhere to the mixing paddle of the vacuum mixer if not completely mixed and this can result in a distorted investment.

We can vibrate the hand-mixed investment to dislodge air bubbles. The purpose of vacuum mixing or vibrating is to remove all air bubbles captured in the mixed investment. After casting, air bubbles against the pattern will appear as nodules of metal. We can usually remove these with pliers but sometimes they have become so firmly attached that we ruin an otherwise good casting.

Hold the flask containing the pattern and vibrate the investment into the flask. The thumb of the left hand is in intimate contact with the vibrator. The thumb acts as a dampening device from vibrations transmitted to the flask and prevents breaking the sprue or wax pattern. The cup containing the investment is placed directly on the vibrator and tilted forward until a steady stream of investment flows into the flask.

When the flask is completely full of investment, we should again vibrate it directly on top of the vibrator with the little finger acting as a cushion. This additional vibration is an added safety measure to be sure that we have captured no air bubbles in the investing process. Naturally, if a vibrator is not available, we can pour the investment directly into the flask.

An alternate method of investing is to directly immerse the pattern into an investment-filled flask. This method is normally used if the pattern has severe undercuts, such as will be found on some frames.

If the pattern is extremely intricate, it is often a good idea to paint the investment on with a small brush. In this manner we can flow the investment into the most intricate cavities. The painting of the pattern is an added safety measure and can be used with either of the two investment methods outlined previously.

Set the invested flask containing the pattern to one side for a minimum of one-half hour. This is necessary to give the investment sufficient time to absorb any free water. If free water is present when the burnout schedule begins, there is a tendency for the water to form steam that will break down or distort the investment.

Remove the bottom plate from the flask with a twisting motion. The point at which the sprue attaches to the bottom plate will normally detach from the plate and be retained in the investment.

When the investment has set for one half hour, it should be hard to the touch. With a sheet metal reamer approximately  $\frac{1}{8}$  inch in diameter smaller than the inside diameter of the flask,

## THE ADVANCE KNIFE MAKERS MANUAL

ream a cavity into the investment. Use the wax sprue wire as a guide to center the reamer. Occasionally clean off the buildup of investment on the reamer. The reamed cavity will hold the casting metal after burnout.

The reamer should have a large radius so it will not cut too deeply into the investment. Reaming the top is necessary to provide a cavity for the melted metal. We ream the bottom to assure that none of the investment projects below the flask so the rim will present a flat surface to the casting machine. We now completely invest the pattern and ready for the burnout process.

### BURNING OUT THE WAX

Since we must make the actual casting immediately after burning out the pattern, while the mold is still hot, burnout and casting are almost one continuous operation. So, the pressure-casting machine must now be set to the correct height. If you are using a large pattern you can probably get by without the pressure machine.

However for the best casting I would recommend the pressure machine. Center the invested flask with respect to the base and the pressure plate. Remove the fulcrum pin and select the correct hole so that the lever arm of the casting machine will be as nearly parallel to the base as possible. Replace the pin. Press the lever arm down so that the pressure plate firmly contacts the flask. Release the pressure and repeat the pressure application to the flask many times. We attach the pressure plate to a swivel and may not completely seat with the first application of pressure. We now adjust the casting machine to receive the flask.

Place the invested flask into the burnout oven, with the sprue opening down. Close the door of the oven and turn on the switch, Normally, the burnout sequence takes about one hour.

This is dependent on the wattage rating of the oven and the number of flasks being burned out at one time.

If your oven is equipped with a pyrometer, it is a simple matter to gradually bring the temperature to 1200 degrees. Hold the temperature at 1200 degrees for ten to twenty minutes. The initial heating of the flask should be with the sprue hole facing down. As the heat penetrates, the wax will become molten and flow through the sprue hole onto the floor of the oven.

This operation of preheating, applying borax and reheating the metal should be done as quickly as possible to prevent excessive loss of heat from both the metal and the invested flask.

If you are using the pressure machine, begin pumping the foot pump to bring the pressure to approximately five to ten pounds. Hold this pressure for approximately two to three seconds



## THE ADVANCE KNIFE MAKERS MANUAL

and then bring the pressure to from twenty to forty pounds. We should maintain the higher pressure for approximately two or three minutes.

The initial pressure will gently force the metal through the sprue opening into the cavity. The higher pressure is necessary to attain density in the finished casting. Remove both the air pressure and the lever arm pressure from the flask. Permit the flask to cool for about five to ten minutes. At this point the casting operation has been completed.

Either a foot pump or a compressor can apply pressure to the casting machine. The compressor, if used, should have a rating of twenty to thirty pounds of free air per minute and a capability of generating at least thirty pounds of pressure. The use of an air compressor will require the modification outlined in the section on how to build a pressure-casting machine.

After the initial cooling period, remove the flask from the casting machine using a pair of suitable tongs. Plunge the flask into a bucket of water at room temperature. As the water contacts the hot investment, steam will be generated and the investment will disintegrate into the water. Permit the flask to remain submerged until completely cooled.

### CLEANING THE CAST PART

If the casting has not already dropped from the flask, when the flask is removed from the water, gently force the casting from the investment. Some investment will stick to the finished casting.

With a stiff bristled brush and a good laundry soap, scrub the casting thoroughly to remove all traces of investment. We can probe stubborn areas with a sharp nail to help remove the investment.

The casting must be pickled to remove the oxide. The pickling solution can be either a 10 percent solution of sulfuric acid in water. Although the acid-water solution is a little more dangerous, it does a better job. Also a safety reminder, if the acid water solution is used, always pour the acid into the water to prevent splattering of the solution. Pickle the casting until all traces of oxide have been removed. Remove the sprue with either a saw or a pair of nippers. The casting is now completed.

**MAKING A VACUUM MOLDER**

## THE ADVANCE KNIFE MAKERS MANUAL

1. Make the base, which is usually made of 1/2" or 3/4" plywood.
2. Cut the pieces for part No. 1.
3. Now drill a hole in one side in which to thread a piece of pipe. This pipe will lead to a source of vacuum, and an ordinary shop vacuum cleaner will generate sufficient suction but I prefer a vacuum pump made from a air conditioning pump from a automobile.

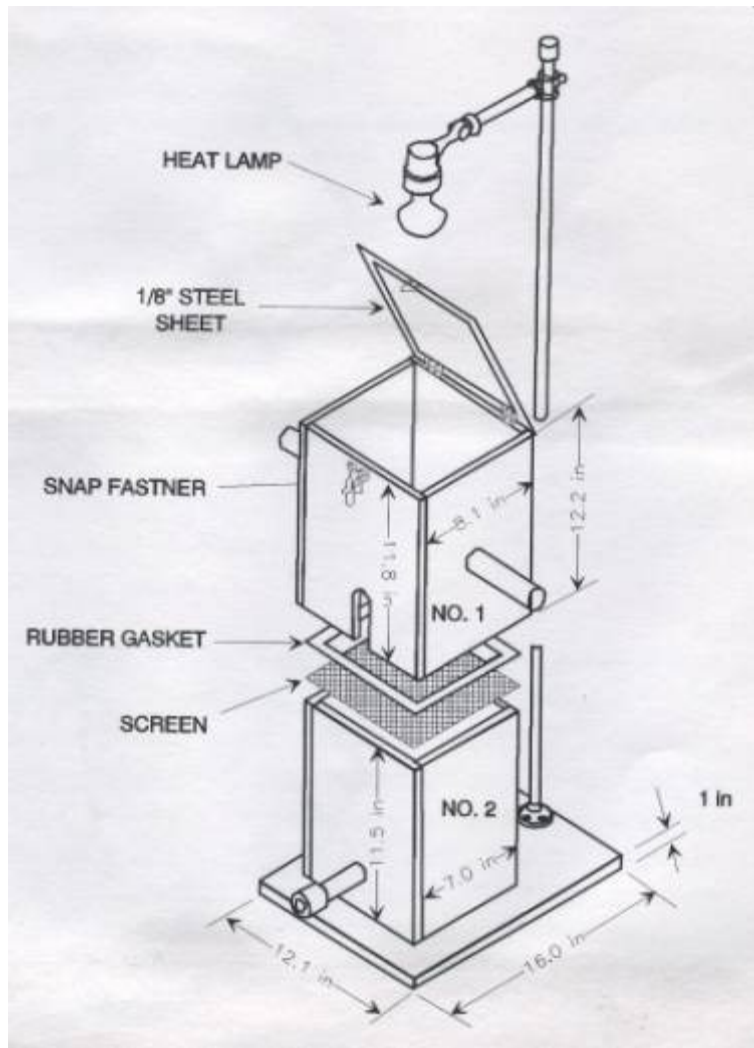

4. Assemble the four sides of part No. 1 with airtight joints using a good wood glue, such as Elmer's glue. Then seal and fasten this assembly to the base with wood screws.
5. Cut a piece of metal window screen to fit the top of part No. 1 and tack it in place.
6. Cut a rubber gasket to fit around the top edge of part No. 1 and cement it in place.

## THE ADVANCE KNIFE MAKERS MANUAL

7. Next, cut the pieces for part No. 2.

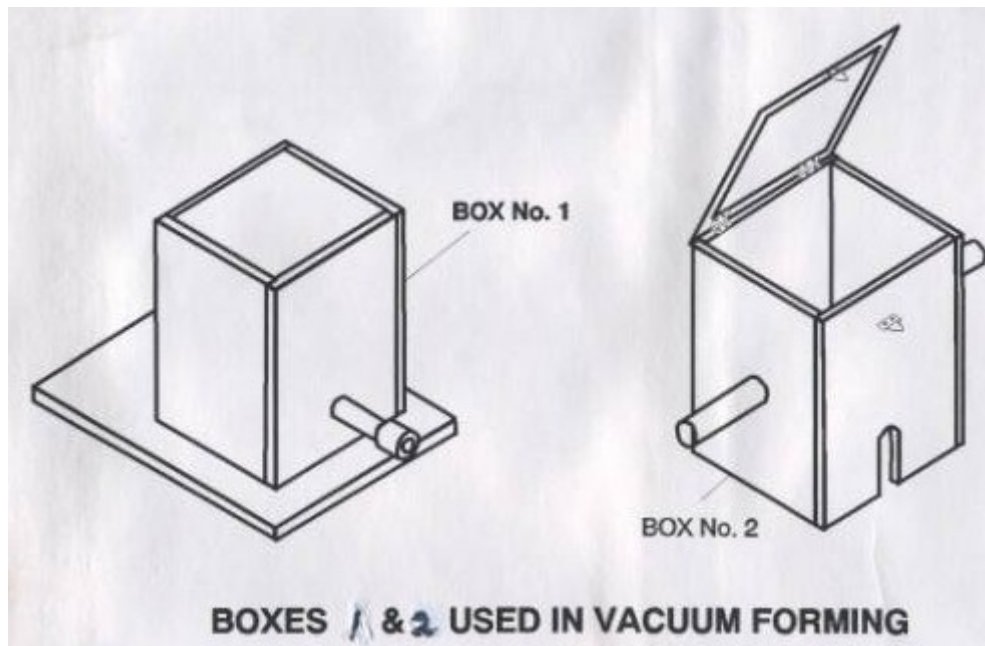

8. Cut out one side to fit down over the pipe in part No. 1.

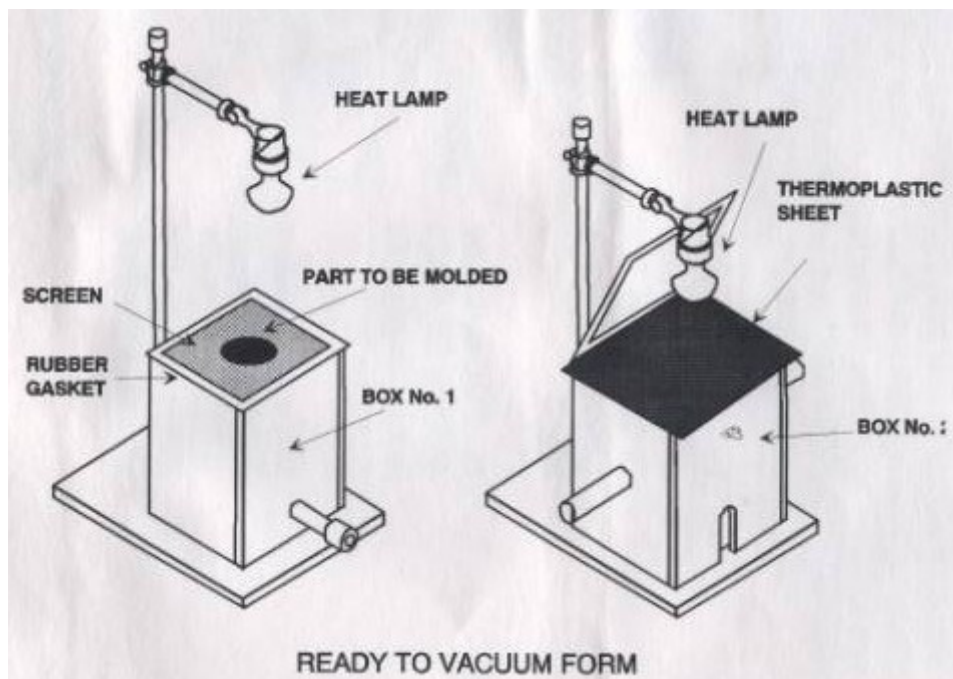

9. Drill the holes halfway through the two opposite sides to take the dowel handles. Fasten the handles in place with glue and wood screws.

10. Assemble the four sides of part No. 2 with airtight joints, and with just enough clearance

## THE ADVANCE KNIFE MAKERS MANUAL

to slip down over part No. 1.

11. Lay out and cut a piece of sheet steel to frame the top of part No. 2, which should be at least 1/8" thick.

12. Fasten the metal frame in place with hinges and a suitable fastener, which can be purchased at any hardware store.

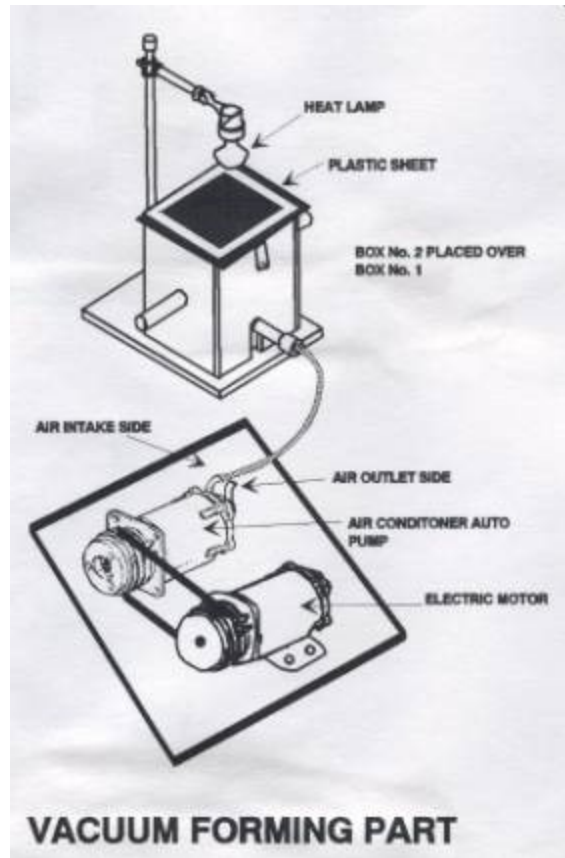

13. Drill and tap threads in the pipe to take the winged stud. This will allow the heat lamp to be adjusted to the proper height above the plastic for efficient heating.

14. Assemble the pipe lamp support parts, align the heat lamp directly over part No. 2 and fasten the pipe flange to the base to complete the equipment.

## USING THE VACUUM FORMING EQUIPMENT

1. Select the pattern which to form the .010 thickness thermoplastic. This thickness of thermoplastic material (cellulose acetate) can be drawn with very fine detail, and without thinning out much, over a pattern not more than 3/8" in thickness. The model may be any type of pattern that you make, or copy, if it is rigid enough to support the plastic sheet as it is heated and vacuum drawn.
2. Place the model on the window screen, part No. 1.
3. Clamp a sheet of plastic under the metal frame of part No. 2.
4. Slip part No. 2 over part No. 1, but do not touch the model with the plastic.
5. Adjust the height of the heat lamp above the plastic. Experiment until the heat lamp causes the plastic to change from a glossy to a dull appearance and sag slightly in a matter of seconds.
6. At the very moment that the plastic is hot, lower part No. 2 over part No. 1 and turn on the vacuum.
7. The formed plastic part maybe immediately removed and used.

# THE ADVANCE KNIFE MAKERS MANUAL

## ETCHING ON METAL

I decided to include the information on etching metal as it has use in many various aspects of metal finishing. If you have artistic talents, you can achieve many designs that will dress up the part.

In etching, a metal plate is first covered with a wax or resists wax, which is an - acid-resist waxing coating of wax, pitch, or asphaltum. The desired design is scratched through this and the plate is then treated with the etching fluid.

On side plates on firearms, designs can be deeply etched and inlaid with silver or gold, or with an inlaying paint. There are many uses for etching in the shop or business.

Of the waxes, paraffin is widely used, being cheap and always available. A thin, even coat is produced by pouring the melted paraffin over the plate that has itself been warmed. Waxes, however, sometimes cause trouble during scribing. If the coating is too cold and hard, it will chip; if too warm, it will pull.



ETCHED SIDEPLATE WITH INLAYS

Ready-made asphaltum varnish may prove more satisfactory for most decorative work. When it is allowed to dry hard, it will cut well and leave clear, sharp lines. If asphaltum varnish gets too cold, it may become too stiff to apply. If, at 70°F, it is still too thick to spread well, thin with a little turpentine.

Etching designs or scenes into the part may enhance a knife part or object. This is done before putting on the handle, by coating the entire gun part or object, with a special wax, scraping the design into the wax with an etching tool. It is then dipping the part into a tank of strong acid until the design is deeply etched into the metal.

## PREPARING THE SURFACE

To make the surface ready for etching, finish it completely smooth and free of pits and blemishes, then polish it to a very fine satin finish, and then buff it to a 600-grit finish before buffing. Then the etching is started, as it should be the last thing done to the part.

# THE ADVANCE KNIFE MAKERS MANUAL

## APPLYING THE WAX

Of the waxes, paraffin is widely used, being cheap and always available. A thin, even coat is produced by pouring the melted paraffin over the plate that has itself been warmed. Waxes, however, sometimes cause trouble during scribing. If the coating is too cold and hard, it will chip; if too warm, it will pull.

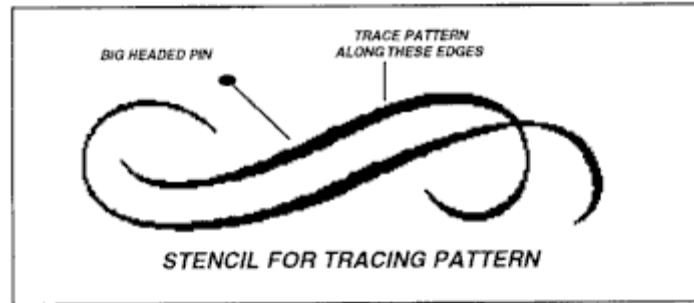

Ready-made asphaltum varnish may prove more satisfactory for most decorative work. Then it is allowed to dry hard, it will cut well and leave clear, sharp lines. If asphaltum varnish gets too cold, it may become too stiff to apply. If, at 70°F, it is still too thick to spread well, thin with a little turpentine. After etching, the varnish may be removed with naphtha or turpentine.

Wash the part very good with a cleanser, and then clean it with acetone, and then coat the entire surface, with etching resist wax. This is prepared from equal parts of powdered asphaltum and melted beeswax. A local art supply store should have these materials. Melt the beeswax in a saucepan, slowly stirring in an equal amount by weight of asphaltum.

Allow the wax to cool, and then break into small chunks that you can use. Heat the part that you are going to etch over a kitchen stove burner or hot plate and rub the resist wax onto the part. The part should be hot enough to get a smooth thin coating over the entire surface, but be careful that it is not so hot as to burn the resist wax. If the resist wax smokes, it has probably become too brittle and you should rewax the part. Inspect the entire surface to be sure it is completely covered with the resist wax. This also includes the areas you do not expect to immerse in the acid bath, as the fumes from the acid bath will etch or pit the surface.

## THE ETCHING TOOL

If you plan to do many etchings, get at least one good etching tool, since your ability clearly to inscribe the design into the wax is limited by the tool. You can make fine little scraping tools of various shapes out of round carbon tool steel, or sewing needles. Use the belt grinder to remove stock in the appropriate places. Harden and temper to a light straw color so the tool will hold its edge while being scraped against the gun part or object.

For very fine detail make a wooden handle from a dowel pin the size of a pencil, and then



## THE ADVANCE KNIFE MAKERS MANUAL

epoxy a needle into a small hole in the end. When you are at the art supply store, check with them as they have some that you can use.

### STENCILS

My drawing was never that good so I had to improvise when making the drawings. I found that I could take a drawing that was on paper and transfer it to the part easily. To do this I held the paper in place on the part and carefully traced the outline to the part with a needle.

The needle was a standard sewing needle that I sneaked from my wife's sewing room. I would carefully punch a hole through the paper following the outline of the drawing that I was using.

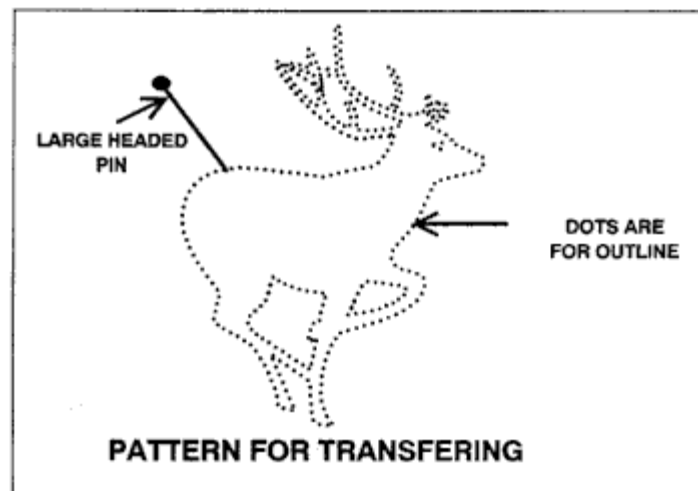

I then removed the pattern from the part and with a large magnifying glass; I carefully traced the outline following the needle holes. This was the quickest way that I could find to do the drawings.

### CUTTING THE ARTWORK INTO THE WAX

If you use the beeswax asphaltum wax, inscribe the artwork under a strong, hot light bulb, so that the wax is warm and pliable. If it is not warm, cutting away the wax is difficult, and will break away from the part. Don't get the wax too warm, or the wax will become sticky, making it hard to get clean lines.

I have found that a large magnifying glass, mounted on a stand, helps to cut fine detail in etching. Magnifying goggles worn by some machinists will also be a big help in cutting fine patterns.

Follow the lines of the gun part or object and you can find many ideas for etching subjects and techniques at the local library. The etching looks more sculptural if the back wax is

## THE ADVANCE KNIFE MAKERS MANUAL

etched out, rather than line drawings. Cut through the wax, clear down to the steel, even in the fine lines and in detailed drawings.

### USING THE ACID BATH

You will need to experiment on practice parts before you can get a clear, well defined etch regularly. Another problem that you will experience is that all the gun part or objects are different, and the acid influences them in different ways, so experiment on different steels before starting.

Before you immerse the wax-coated finished part into the acid, make sure there are no nicks or scratches in the wax anywhere outside the area to be etched. The wax tends to get very thin along the edges of the part. Coat these areas with an extra layer of wax just before immersing it in the acid. To do this, take a small piece of wax material and with a cigarette lighter and paint this onto the warmed part along the areas where the wax looks thin or nicked.

## ETCHING SOLUTIONS

Solutions for etching metal should always be mixed and applied in glass containers or containers heavily coated with asphaltum. Glass photographic trays or baking pans are excellent for flat work. Rectangular, one-piece fish tanks will serve for large work.

Nitric acid is used in etching most metals. For fast etching, this may be used full strength. For slower action carefully stir one part of acid in one part of water. When the process is carried out with a diluted solution, it is well to stir occasionally or to rock the tray to remove bubbles and scale that may interfere with even biting. Store the acid and solution in Teflon bottles or in glass bottles with acid-proof caps.

(Caution: Handle nitric acid with great care; it is extremely corrosive. Wear rubber gloves when mixing or using it; always add the acid to the water, and not vice versa; don't spill or spatter it. If you spill any on your skin, flush immediately with plenty of cold water.)

## AQUA REGIA ACID

The basic acid used to etch steel is called Aqua Regia and consists of three parts muriatic (hydrochloric) acid to one part nitric acid. You can get muriatic acid and nitric acid at chemical supply houses.

Acid is very dangerous. Aquas Regia is particularly dangerous, so always mix and use the acid outdoors. Always stand upwind of the acid because the fumes are very potent and can damage your lungs.

Do the etching where there is running water and baking soda on hand in case you need to flush and neutralize acid that has splashed on you. Never pour water or baking soda into the acid bath and never add water to acid, only acid to water, and then very slowly.

I strongly recommend wearing some type of face shield, and a chemical mask when working with the acid. When you are finished with a batch of acid, dig a large hole in the ground well away from people, plants, and animals, and pour it in there.

There are many different combinations of Aqua Regia, with water or additional hydrochloric acid added to the basic three-to-one Aqua Regia mixture. I have obtained the sharpest, cleanest etch, and with the least problems of lifting of the wax, with straight Aqua Regia that has been aged about one month. When you mix the two acids together, a chemical change occurs, as evidenced by prolonged bubbling and a change of color. If you use the acid while it is new and has not aged, you may find that the etching is very fast, but that the wax lifts even faster, and a too shallow etching.

The good thing about fresh acid that is, acid that you begin using after one month of aging is that the etching, though shallow, is very clean. Every detail will be etched perfectly, and the

# THE ADVANCE KNIFE MAKERS MANUAL

back wax will be absolutely free of imperfections.

After you have etched 50 to 100 parts with a batch of one to two gallons, you will notice some changes taking place in the back wax of your etchings, so then it is time to make up new acid.

## ETCHING COPPER AND BRASS

First clean the metal with any available soft abrasive powder, such as whiting or talc, and then wipe the surface with a soft cloth, being careful to remove all fingerprints. Paint all portions not to be etched with an even coat of asphaltum varnish. If a design is to be etched in, coat the entire surface. When the coating is dry, draw or trace the design on the asphaltum with a soft lead pencil. With a sharp scratch awl or other needle pointed tool then cut the lines through to the metal.

When ready, lower the piece carefully into the etching bath with plastic tongs. Full-strength, technical-grade nitric acid will etch copper and brass to a depth of about 0.002 of an inch in a minute. For all ordinary purposes the etching will be deep enough in from a minute to a minute and a half. A half-and half solution will require longer, but should be used where a deep etch is wanted.

## ETCHING ALUMINUM AND STEEL

Aluminum is etched in the same way as copper and brass, except that muriatic (hydrochloric) acid is used instead of nitric. Full-strength muriatic acid will etch to a depth of about 0.003 of an inch per minute. The etching will be slower, but can be kept under better control, if the acid is diluted one part acid to two to three parts water.

An easy way to etch aluminum is to first heat the metal enough to melt wax, lay it flat on half a dozen thickness of newspaper, and flow on a thin coat of the wax. When the coated metal is cold, scratch on the design or lettering, cutting right through the wax film to the metal. Apply the solution to the scratched areas with a small wad of absorbent cotton fastened to the end of a short stick with a rubber band. When the metal has been etched deeply enough, wash thoroughly with water and then remove the wax with boiling water. (Caution: Although muriatic acid is not quite as corrosive as nitric acid, it should be handled with the same care.)

Steel may be etched quickly and satisfactorily with a solution made by mixing one part muriatic acid with one part technical nitric acid. (Caution: Be especially careful with this combination, as it is more corrosive than either of the separate acids. If you store it in a bottle, leave the cap loose for the first one hour, as during that time it gives off gas.)

Among other applications, you may use this solution for etching names and designs on tools. Clean the metal thoroughly with whiting or other mild abrasive powder and wipe with a cloth. Outline the name or design with asphaltum varnish, or coat the tool all over with asphaltum and scratch the figure in this after it is hard and dry. Then apply a few drops of the solution to

## THE ADVANCE KNIFE MAKERS MANUAL

the part to be etched and let remain until the etching is deep enough. Rinse with water. After removing the asphaltum with solvent, dry the tool and coat it with oil or other rust preventive.

### TEMPERATURE OF THE ACID BATH

The acid should be about 70 to 75° F., otherwise the etching is too slow, and the wax could lift before the etching is deep enough. I usually warm up the acid with a light bulb shining into the bath from above.

When you are using the bath, the temperature will increase due to the action of the acid. If you etch many parts on the same day, you will find that the temperature has increased, and with it the intensity of etching of the acid. You can easily ruin a gun part or object by having the acid too hot.

### BATH

The best position for the gun part or object is flat in a pan with the etching facing up. When the part is setting so the etching is facing the side, the bubbles given off by the action rise, and follow the surface of the part, causing this area to etch faster.

### ETCHING THE PART

After checking the part for nicks, scratches, and thin spots in the wax, place the part into the acid, etching facing up. About every ten minutes or so take out the part or object and carefully inspect it. Brush out the etching with a soft acid brush. This brushing action swabs out the residue caused by the chemical action, leaving a clear area between the steel and the acid.

As you gain experience you can probably tell when the etching is ready, since the time will vary on the steel, how much etching activity in the tank, age and strength of the acid, acid, and temperature. The higher the temperature, the faster it will etch. If you have used the acid for a while, the weaker it becomes, and the more surface being etched, the higher the rate of activity, and the faster it will etch.

The etching should be noticeably cut out when it is done. After examining the etched part carefully, touch a spot very carefully with a sharp tool such as a needle to decide if there is enough depth to the etching. If the wax is starting to lift, quitting it is best and scrape off the wax. You can heat the part and then with several paper towels wipe it clean, or you can put it in a pan of boiling water, and then let the water cool before removing the part. By doing this, the wax can be retrieved and used again.

# THE ADVANCE KNIFE MAKERS MANUAL

## SHARPENING KNIVES

Most people cannot sharpen a knife, but with a little instruction and practice will become proficient at it. A person is not born with the ability of knife sharpening, but to sharpen a blade correctly is an acquired skill and can be only mastered with lots of practice.

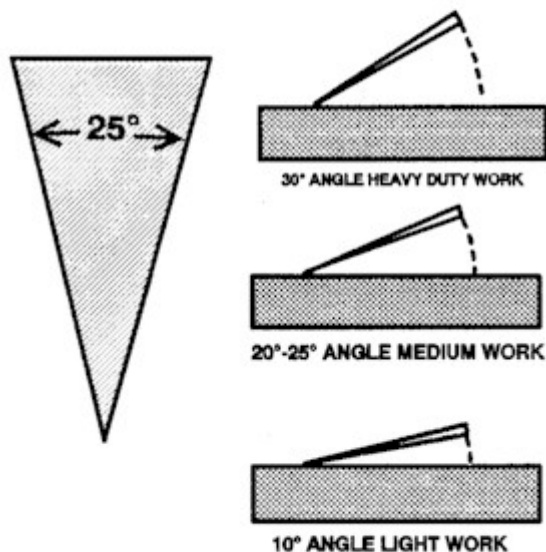
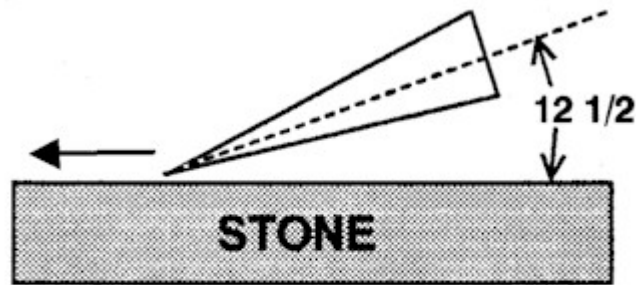

## SHARPENING A BLADE

A person usually grabs a knife when sharpening, and grinds the blade away on an emery wheel, which is the wrong way to do so. What is the correct angle that an edge must have for the knife to be sharpened correctly? I tell people that the proper angle is not a hard, set rule, but varies, accordingly to the material on which the knife will be used. If you are going to slice meat, a thin edge of some 15 degrees should work fine, but if your knife will be used for all type of abusive work, I would suggest an edge of 30 to 40 degrees. For a person that uses the knife for a general-purpose knife, the angle should be about 25 degrees.

## THE CORRECT ANGLE

The degrees listed above are the degrees actually used on the blade of the knife. When

## THE ADVANCE KNIFE MAKERS MANUAL

sharpening on the whetstone, for you to get 25 degrees on the blade, hold the blade at 12 1/2 degrees on the stone. I want to point out that this is not a hard and fast rule and one type of blade will work much better at 25 degrees than another of different steel and shape. I would suggest sharpening your knife at different angles until you find what works best for your needs.

I like to use three different stones when I sharpen a blade. The Medium Red India, Washita, and the Hard Arkansas. After finishing with this, a ceramic stick and leather strop can be also used. The Red India is a man-made stone put out by Norton. The Washita and Hard Arkansas are natural stones that they have quarried in Arkansas. The ceramic stick is a man-made rod of alumina ceramic.

When first sharpening a knife, I will start with the Red India. Be sure to hold the back of the blade at the proper angle for the type of use for which you plan to use it. Stroke the edge on the stone as shown in the drawing, from the choil to the point. Make a pass across the stone so that it looks as if you are trying to slice off a layer of the stone.

Stroke the blade first on one side and then the other. Be careful that you do not roll the cutting edge on the stone. When reaching the end of a stroke, stop and lift the blade straight up, reverse direction and commence with the other stroke. You need to use plenty of oil with the Red India stone.

The oil will keep particles of steel in suspension. If we allow these particles of steel to remain on the stone without the using oil, they will clog the stone and eliminate the abrasive action that cuts steel.

When you are through using the Red India stone, your knife should now cut through a newspaper without tearing the paper. For most people the sharpness of this edge will be just fine.

For many of us a sharper knife is more desirable and should go from the Red India to the Washita stone. The same strokes and methods are used on the Washita as on the Red India. You do not need to use as much pressure of the blade against the stone in this second operation. After you do this a few times, you can feel the edge and know when it is just right. The Washita stone will put an excellent shaving edge on your knife.

If you want the ultimate in sharpness, you want to continue to the Hard Arkansas Stone. The Hard Arkansas is of the same material as the Washita, but it is a much harder and smoother stone. It should be used the same as with the above stones. After using the Hard Arkansas stone, a leather strop is normally used to finish the blade.

### STROPPING THE BLADE

We can make a good strop from a large piece of shoe sole leather available at the shoe repair shop and attached with glue to a block of wood of the correct size.

## THE ADVANCE KNIFE MAKERS MANUAL

There also they call a ceramic stick that I use and have found to be good. I like to use my Crock Stick to touch up a blade a little from time to time. When using a stone, strop, or crock stick, always fasten the sharpener to a good steady bench or table. Your stones should be kept in a suitable box for protection. Often, when you buy the stones you get the boxes for them also. Most of the boxes are made of wood, while some are made of aluminum.



# THE ADVANCE KNIFE MAKERS MANUAL

## KNIFE PATTERNS

The following pages have several knife patterns that you can use. To use these, you can go to your local library or any place that has a copying machine. Make a copy of the patterns that you want and then glue them on a piece of thin cardboard.

Then cut them out closely to the lines and transfer them to the steel that you are planning to make the knives from. These patterns can be enlarged or reduced to the size that you want.

Cut them out on the band saw and follow the instructions that are in this book.

### Large Trapper

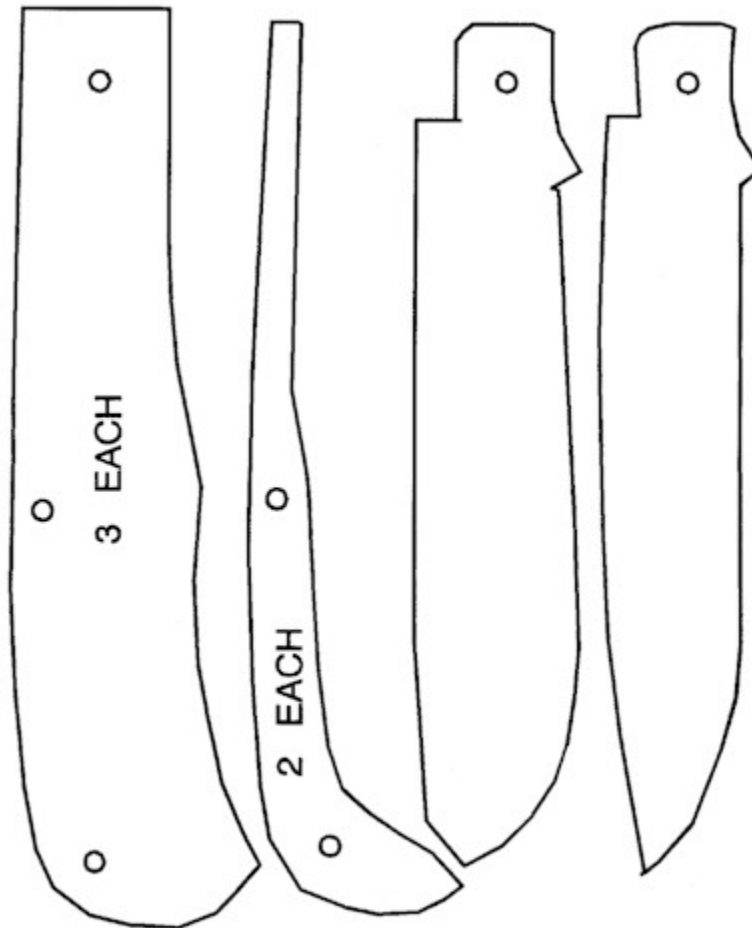

### LARGE TRAPPER

**Large Utility Knife**

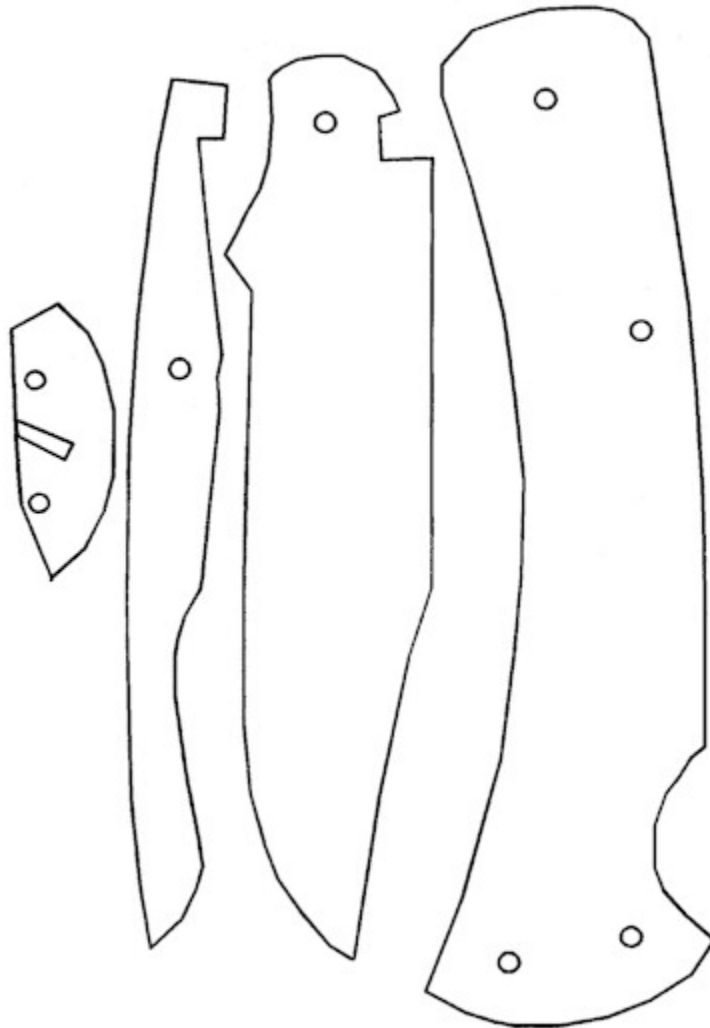

**LARGE UTILITY KNIFE**

Muskrat Knife

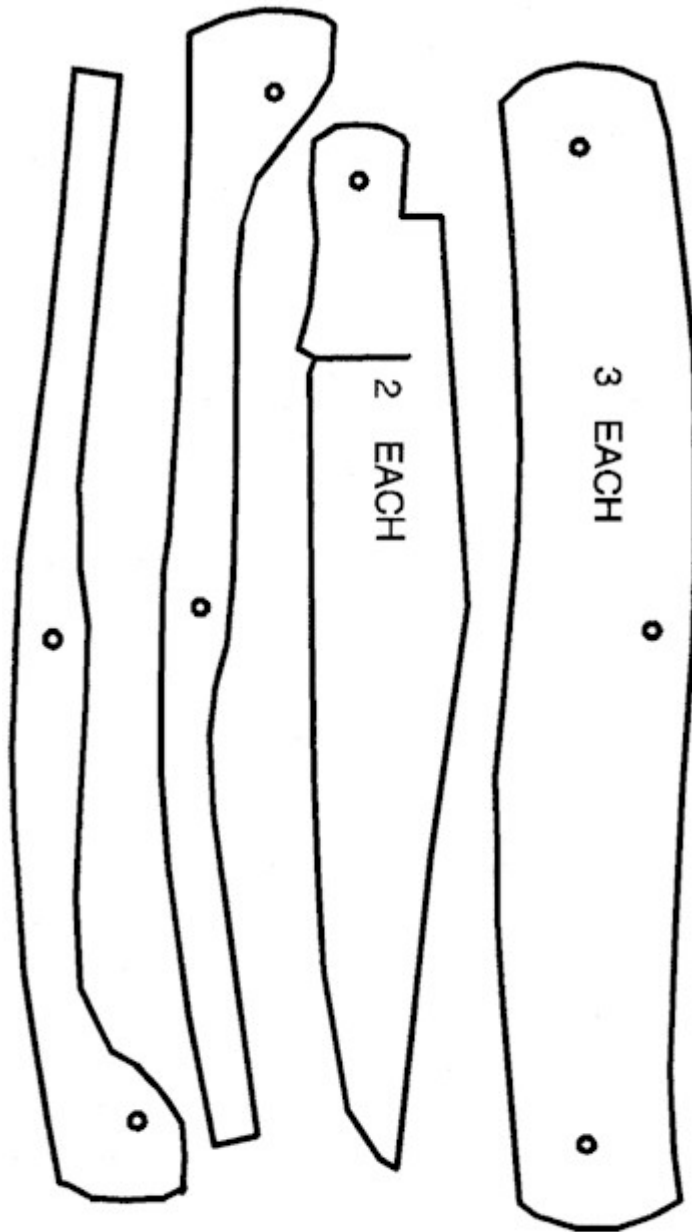

MUSKRAT TWO BLADE KNIFE

Medium Trapper

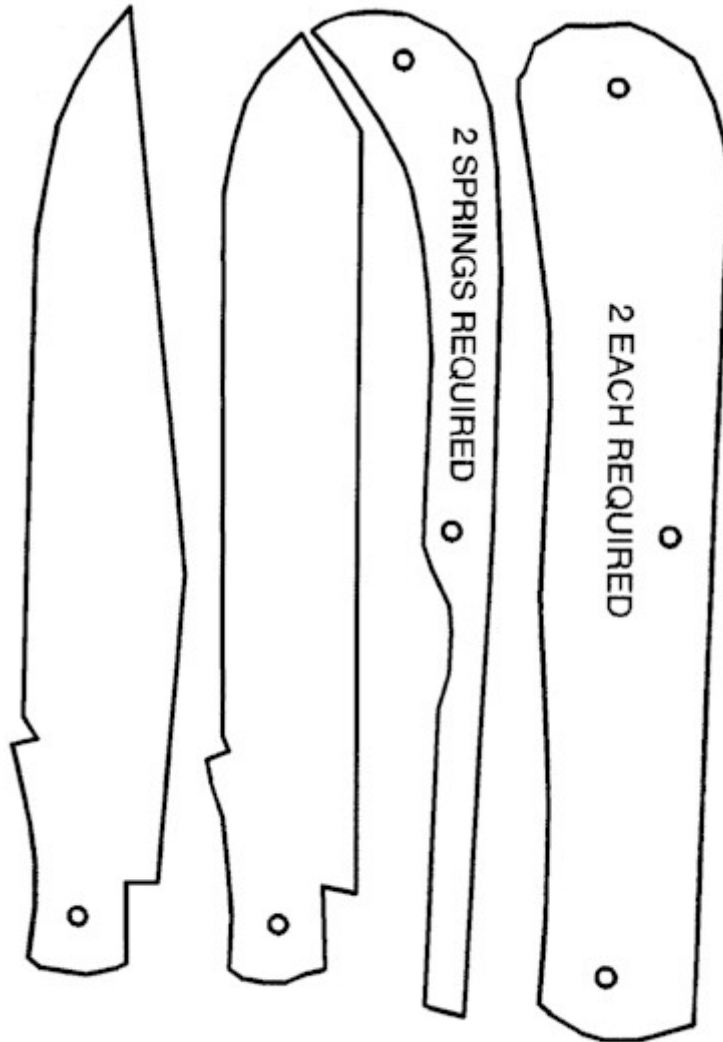

MEDIUM TRAPPER

Puma Style

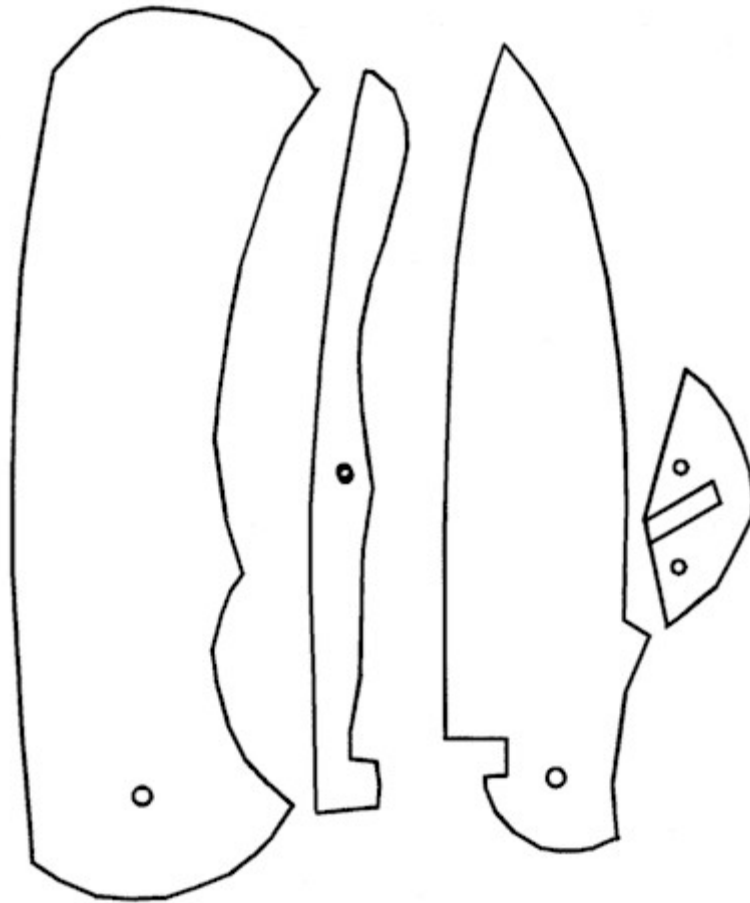

PUMA STYLE HUNTER

Small Pocket Knife

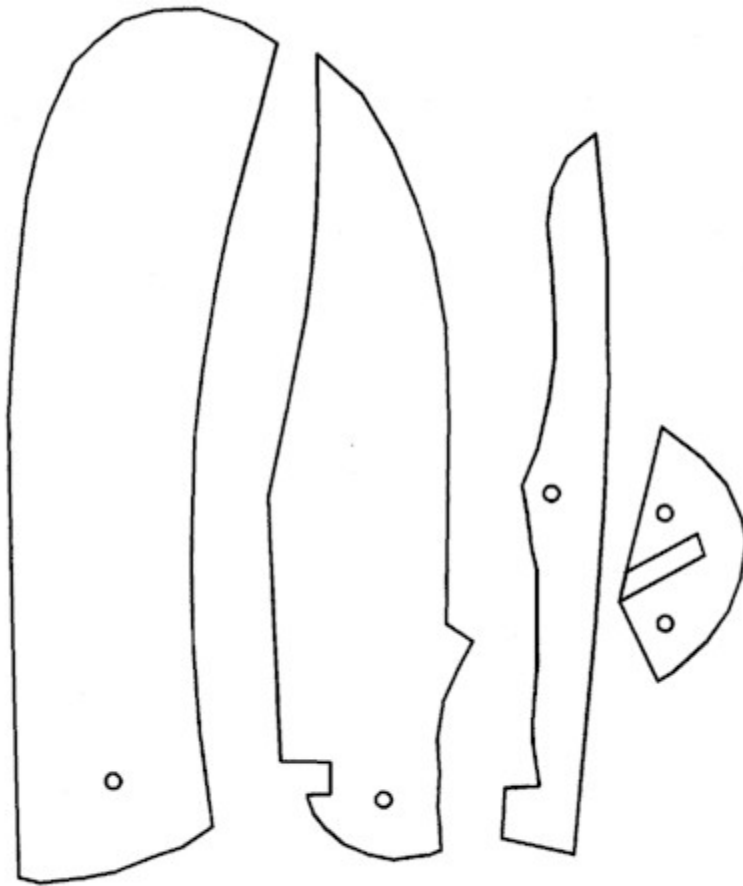

SMALL POCKET KNIFE

Small Hunter

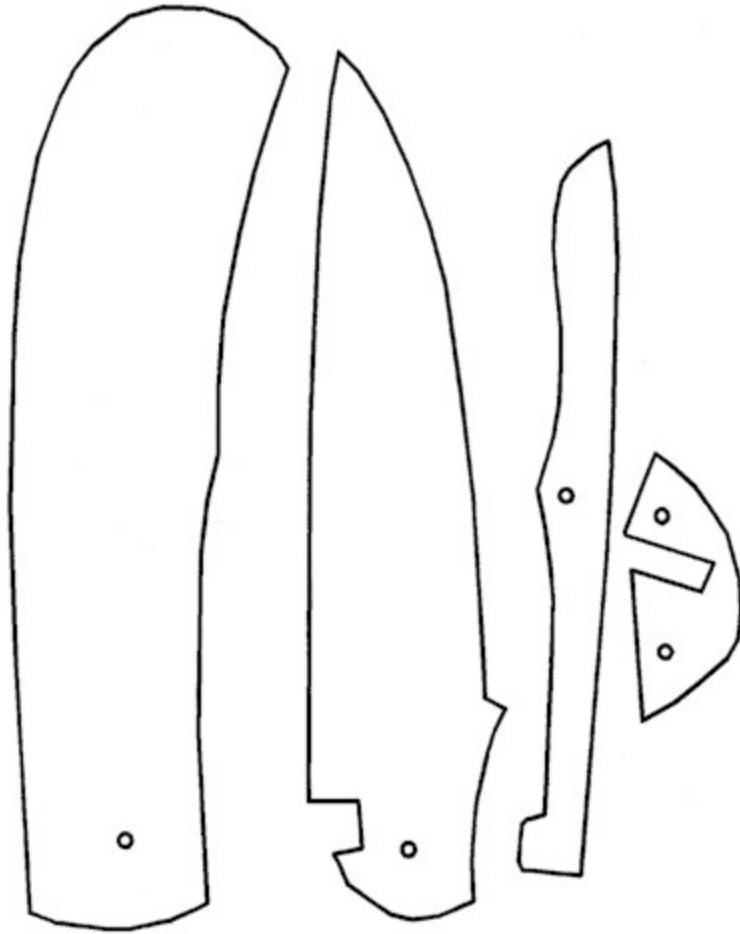

SMALL HUNTER

Texas Toothpick

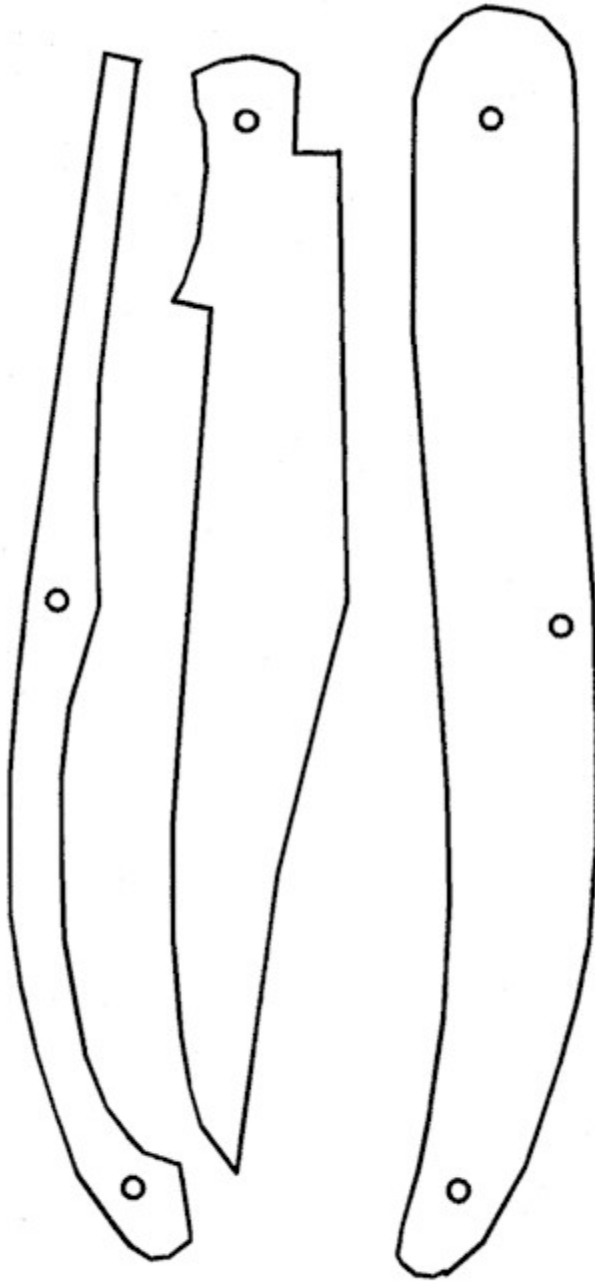

TEXAS TOOTH PICK



## SUPPLIERS & MANUFACTURES

American Buff Co.

PO Box 327

Claremont, NC, 28610

Berg & Ash Tool

1218 Santa Fe Ave

Detroit, Michigan

Chicago Wheel & MFG.

1101 W Monroe St.

Chicago, Il 60607

Dremel MFG.

4915 21st St.

Racine, WI 53406

Forster Products

82 E Lanark Av.

## THE ADVANCE KNIFE MAKERS MANUAL

Lanark, Il 61046

Henriksen Tool Co.

PO Box 668

Phoenix, Or 97535

International Nickel Co.

1 New York Plaza

New York, NY 10004

JGS Tool MFG.

1141 S. Summer Rd.

Coos Bay, Or 97420

United Mineral/Chemical

129 Hudson St.

New York, NY, 10013

Wholesale Tool

8758 Clay Road, Bldg. 410

Houston, Texas 77080

## THE ADVANCE KNIFE MAKERS MANUAL

Wholesale Tool

4200 Barringer Drive,

Box 240965

Charlotte, NC 28210

Allied Chemical Corp.

Plastic Div.

40 Rector St.,

New York NY 10006

Argo Plastic Product Co.

PO Box 18141

Cleveland, Ohio 44118

Celanese Plastic Co.

744 Broad St.

Newark, NJ 07102

Durez Plastic Div.

Hooker Chemical Corp.

1967 Walck Rd.

## THE ADVANCE KNIFE MAKERS MANUAL

North Tonawanda, NY 14121

Karman Rubber

2331 Copley Rd.

Akron, Ohio 44320

Aeroquip Corp.

Republic Rubber Div.

1410 Albert St.

Youngstown, Ohio 44501

Arwood Corp.

515 Madison Ave.

New York, NY 10022

Investment Casting Co.

60 Brown Ave.

Springfield, NJ 07081

Midwest Precision Castings

10703 Quincy Av.

## THE ADVANCE KNIFE MAKERS MANUAL

Cleveland, Ohio 44106

(501) 646-4711

Biesemeyer Manufacturing Corp.

216 S. Alma School Rd., Suite 3

Mesa, AZ. 85202

(602) 835-9300

Binks Manufacturing Company

9201 W. Belmont Ave.

Franklin Park, Il 60131

(312) 671-3000

(301) 467-741 1

Bosch Power Tool Corporation

3701 Neuse Boulevard

New Bern, NC 28560-9399

(704) 528-4528

(617) 585-4364

(216) 5483481

Craftsman Tools

## THE ADVANCE KNIFE MAKERS MANUAL

Sears, Roebuck And Co.

925 S. Homan Avenue

Chicago, Il 60607

Delta International Machinery Corp.

246 Alpha Drive

Pittsburgh, Pa 15238

(800) 438-2487

Dremel, Division Of Emerson Electric Co.

4915 21st Street

Racine, WI, 53406

401-403 Kennedy Blvd. P.O. Box 24

(609) 784-8600

(603) 585-6883

(203) 792-8622

Grizzly Imports, Inc.

P.O. Box 2069

Bellingham, WA 98227

(206) 647-0801

## THE ADVANCE KNIFE MAKERS MANUAL

4487-F Park Drive

(404) 925-1774

(617) 639-1000

(416) 293-8624

Jet Equipment & Tools

P.O. Box 1477

Tacoma, WA 98401

(206) 572-5000

Laser Machining, Inc.

500 Laser Drive

Somerset, WI 54025

(715) 247-3285

(503) 257-8957

(213) 926-8775

Milwaukee Electric Tool Corp.

13135 West Lisbon Road

Brookfield, WI 53005

(414) 781-3600

## THE ADVANCE KNIFE MAKERS MANUAL

(305) 633-6372

704-743-5551

Paasche Airbrush Co.

7440 West Lawrence Ave.

Harwood Heights, Il 60656

(312) 867-9191

(802) 674-5984

Porter Cable

Box 2468

Jackson, Tn. 38302

(615) 473-5551

Rbindustries, Inc.

201 First Street

Pleasant Hill, Mo 64080

Roto/Carve

6509 Indian Hills Rd.

Minneapolis, Mn 55435



## THE ADVANCE KNIFE MAKERS MANUAL

(612) 944-5150

(612) 755-1600

Sand-Rite Manufacturing Co.

1611 North Sheffield Avenue

Chicago, Il 60614

Shopsmith, Inc.

6640 Poe Avenue

Dayton, Oh 45414-2591

Skill Corporation

4801 West Peterson Avenue

Chicago, Il 60646

Sperber Tool Works, Inc.

Box 1224

West Caldwell, NJ 07007

(201) 744-6110

Stewart-Warner Corporation

1826 Diversey Parkway

## THE ADVANCE KNIFE MAKERS MANUAL

Chicago, Il 60614

(612) 5614210

(717) 296-8009

(217) 963-2232

(209) 678-7409

(717) 846-2800

(603) 673-3446

(617) 935-5860

Woodmaster Tools, Inc.

2908 Oak Street

Kansas City, Mo 64108

(816) 756-2195

Woodmizer

8180 West 10 Th Street

Indianapolis, In 46224

(317) 271-1542

Woodworker's Supply

5604 Alameda NE

## THE ADVANCE KNIFE MAKERS MANUAL

Albuquerque, NM 87113

(505) 821-0500

These are the main suppliers that I have used. A complete list can be found in the Knife Digest and other product catalogs in the back of the book under suppliers.