

NASA/TM-2014-218514



Review of Research on Angle-of-Attack Indicator Effectiveness

Lisa R. Le Vie
Langley Research Center, Hampton, Virginia

August 2014

NASA STI Program . . . in Profile

Since its founding, NASA has been dedicated to the advancement of aeronautics and space science. The NASA scientific and technical information (STI) program plays a key part in helping NASA maintain this important role.

The NASA STI program operates under the auspices of the Agency Chief Information Officer. It collects, organizes, provides for archiving, and disseminates NASA's STI. The NASA STI program provides access to the NASA Aeronautics and Space Database and its public interface, the NASA Technical Report Server, thus providing one of the largest collections of aeronautical and space science STI in the world. Results are published in both non-NASA channels and by NASA in the NASA STI Report Series, which includes the following report types:

- **TECHNICAL PUBLICATION.** Reports of completed research or a major significant phase of research that present the results of NASA Programs and include extensive data or theoretical analysis. Includes compilations of significant scientific and technical data and information deemed to be of continuing reference value. NASA counterpart of peer-reviewed formal professional papers, but having less stringent limitations on manuscript length and extent of graphic presentations.
- **TECHNICAL MEMORANDUM.** Scientific and technical findings that are preliminary or of specialized interest, e.g., quick release reports, working papers, and bibliographies that contain minimal annotation. Does not contain extensive analysis.
- **CONTRACTOR REPORT.** Scientific and technical findings by NASA-sponsored contractors and grantees.

- **CONFERENCE PUBLICATION.** Collected papers from scientific and technical conferences, symposia, seminars, or other meetings sponsored or co-sponsored by NASA.
- **SPECIAL PUBLICATION.** Scientific, technical, or historical information from NASA programs, projects, and missions, often concerned with subjects having substantial public interest.
- **TECHNICAL TRANSLATION.** English-language translations of foreign scientific and technical material pertinent to NASA's mission.

Specialized services also include organizing and publishing research results, distributing specialized research announcements and feeds, providing information desk and personal search support, and enabling data exchange services.

For more information about the NASA STI program, see the following:

- Access the NASA STI program home page at <http://www.sti.nasa.gov>
- E-mail your question to help@sti.nasa.gov
- Fax your question to the NASA STI Information Desk at 443-757-5803
- Phone the NASA STI Information Desk at 443-757-5802
- Write to:
STI Information Desk
NASA Center for AeroSpace Information
7115 Standard Drive
Hanover, MD 21076-1320

NASA/TM-2014-218514



Review of Research on Angle-of-Attack Indicator Effectiveness

Lisa R. Le Vie
Langley Research Center, Hampton, Virginia

National Aeronautics and
Space Administration

Langley Research Center
Hampton, Virginia 23681-2199

August 2014

Acknowledgments

This work was conducted under the NASA Aviation Safety Program's Vehicle Systems Safety Technologies (VSST) Project. The support of the Project Manager, Mr. Paul Krasa, is gratefully appreciated.

The use of trademarks or names of manufacturers in this report is for accurate reporting and does not constitute an official endorsement, either expressed or implied, of such products or manufacturers by the National Aeronautics and Space Administration.

Available from:

NASA Center for AeroSpace Information
7115 Standard Drive
Hanover, MD 21076-1320
443-757-5802

Table of Contents

1. Introduction	2
2. Angle-of-Attack.....	4
3. Historical Research.....	6
4. AoA in the Cockpit.....	10
4.1 General Types	12
4.2 Military AoA Systems.....	17
4.3 Commercial Transport and Business Aircraft AoA Indicators	19
4.4 AoA on the HUD.....	22
4.5 General Aviation AoA Systems	24
5. AoA Display Benefits.....	28
5.1 Energy State Awareness/Upset Recovery	28
5.2 Detect/Diagnose Air Data System Failures.....	30
6. Training	32
7. Concluding Remarks	34
8. Recommendations	35
9. References	36

List of Figures

Figure 1: Aircraft Accident Statistics for Worldwide Commercial Fleet 2003-2012.....	2
Figure 2: Angle-of-Attack, Flight Path Angle and Pitch attitude	4
Figure 3: Lift at Angle of Attack	5
Figure 4: Different Pitch Attitudes and Stall AoA.....	5
Figure 5: Common AoA Sensor Types.....	10
Figure 6: Angle of Attack sensor on Embraer 145	11
Figure 7: Specialties AoA indicator displaying arbitrary numbers	11
Figure 8: Teledyne Avionics Angle of Attack Indicator	12
Figure 9: AoA Indicator displaying degree units.....	12
Figure 10: Inset of Boeing AoA Gauge	13
Figure 11: Specialties, Inc. B-2 Dial-type AoA Indicator	14
Figure 12: Specialties, Inc. AoA Approach Index Indicator	14
Figure 13: AoA Display and Key	15
Figure 14: AoA Indexer	16
Figure 15: T38 AoA System and Displays	17
Figure 16: Navy F/A-18 HUD display showing AoA and the AoA Bracket	18
Figure 17: Navy F/A-18 AoA Indexer.....	18
Figure 18: F-16 AoA Display System	19
Figure 19: Cessna AoA Indicator and Indexer	20
Figure 20: Optional Airbus AoA Indicator	20
Figure 21: Boeing AoA Gauge	21
Figure 22: Gulfstream PFD AoA Located Under Airspeed Tape.....	22
Figure 23: Rockwell Collins HGS6250 AoA Indicator	23
Figure 24: Rockwell Collins HGS4200 AoA Indicator	24
Figure 25: Garmin GI 260 Angle of Attack Indicator	25
Figure 26: Garmin G3X AoA System	26
Figure 27: Alpha System AoA Griffin Chevron Display	26
Figure 28: ICON A5 Light Sport Aircraft AoA indicator	27

Nomenclature

AAIU	Air Accident Investigation Unit
AFM	Airplane Flight Manual
AoA	Angle of Attack
BEA	Bureau d'Enquêtes et d'Analyses
CRJ	Canadair Regional Jet
FAA	Federal Aviation Administration
HGS	Head-up Guidance System
HUD	Head-Up Display
LOC-I	Loss-of-Control – In Flight
NASA	National Aeronautics and Space Administration
NATO	North Atlantic Treaty Organization
NTSB	National Transportation Safety Board
PFD	Primary Flight Display
UPS	United Parcel Service
USAF	United States Air Force
VSST	Vehicle Systems Safety Technologies

Abstract

The National Aeronautics and Space Administration (NASA) conducted a literature review to determine the potential benefits of a display of angle-of-attack (AoA) on the flight deck of commercial transport that may aid a pilot in energy state awareness, upset recovery, and/or diagnosis of air data system failure. This literature review encompassed an exhaustive list of references available and includes studies on the benefits of displaying AoA information during all phases of flight. It also contains information and descriptions about various AoA indicators such as dial, vertical and horizontal types as well as AoA displays on the primary flight display and the head up display. Any training given on the use of an AoA indicator during the research studies or experiments is also included for review.

1. Introduction

Accidents resulting from Loss of Control – In Flight (LOC-I) continue to be the principal cause of commercial transport aviation fatalities worldwide (Figure 1). Between 2003 and 2012, 24 percent of fatal accidents, accounting for 39 percent of total aviation fatalities, were attributable to LOC-I. Of these, 59 percent occurred during the takeoff/initial climb and final approach/landing phases of flight (Boeing, 2013). In response to these findings, cooperative industry-government research into flight deck technologies, with the potential to minimize the problems and contributing factors of loss-of-energy state awareness, has been initiated.

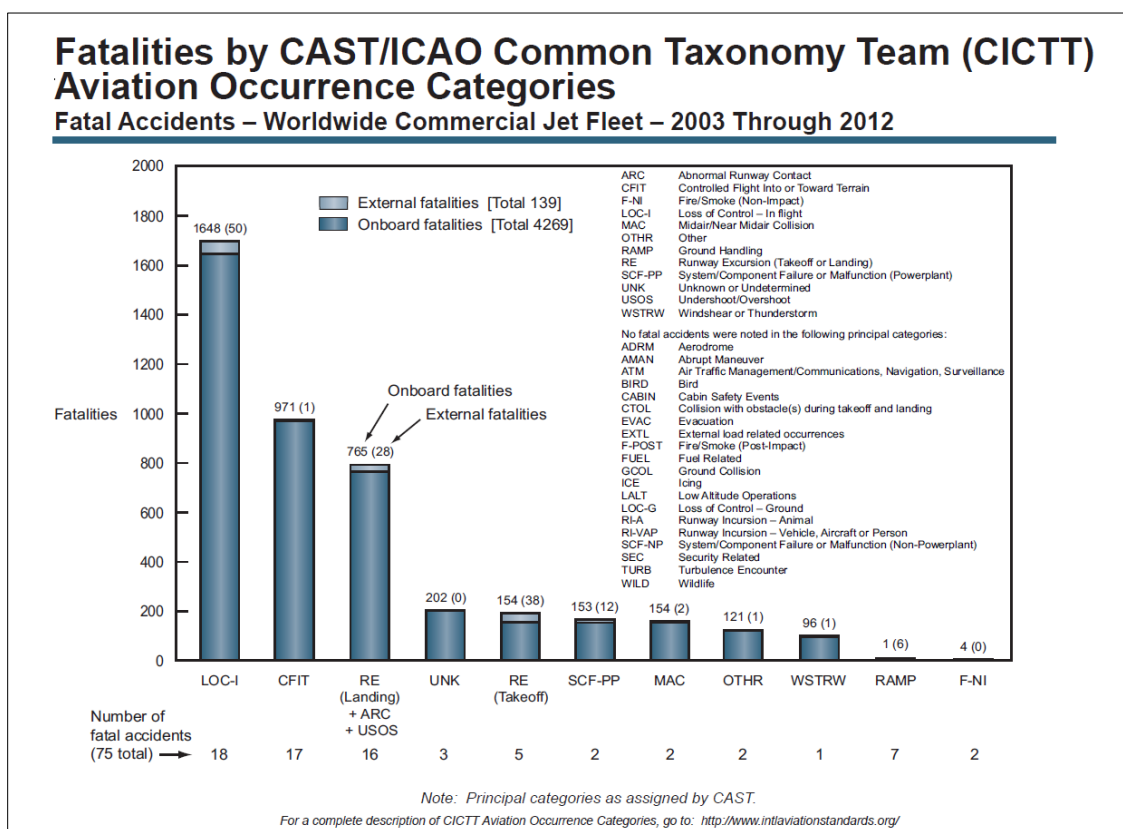

Figure 1: Aircraft Accident Statistics for Worldwide Commercial Fleet 2003-2012 (Boeing, 2013)

One technology that has been proposed to increase the pilot’s ability to avoid, detect, and recover from situations that may lead to LOC-I is an angle-of-attack (AoA) display. This idea is motivated by the following: AoA information is considered most useful to the flight crew to show the margin to stall or stall warning, and AoA information may also be useful in the diagnosis of an air data system (e.g., pitot or static system) failure. An AoA indicator may further aid the pilot in recovering the aircraft from an upset situation.

An airplane upset occurs when an airplane unintentionally exceeds the normal flight parameters found in either line operations or training. They are unintentional in nature because the aircraft is not doing what it was commanded to do, and therefore is entering

unsafe conditions. Upsets can be attributed to the environment, equipment and/or pilots (Upset Recovery Industry Team, 2008).

While each airplane model's specific value may vary, the following criteria are generally used to define an airplane upset situation (Upset Recovery Industry Team, 2008):

- Pitch attitude greater than 25 degrees, nose up;
- Pitch attitude greater than 10 degrees, nose down;
- Bank angle greater than 45 degrees;
- Within the above parameters, but flying at airspeeds inappropriate for the conditions.

The purpose of this research is to review literature from industry, academia and government agencies to evaluate past research on AoA displays and their effectiveness; review the types of AoA systems and their use; discuss the potential benefits of AoA displays to aid in energy state awareness, upset recovery and diagnosis of air data system failures; and review any previous training given or currently suggested regarding AoA indicators.

2. Angle-of-Attack

Angle-of-attack (AoA) is an aerodynamic parameter critical to understanding airplane stability, performance and control. AoA is the angle between a reference line on the airplane or wing and the relative wind or on-coming air.

Two other angles are more commonly referred to in reference to the fuselage (Figure 2). They are the pitch angle (attitude) and the flight path angle. The pitch angle is the angle between the fuselage and the horizon and is displayed on either the artificial horizon or the attitude indicator. The flight path angle, also referred to as the climb or descent angle, is calculated as the vertical angle between the velocity vector (i.e., where the airplane is going) and the Earth's horizon and can be displayed on the primary flight display as a flight path vector. In still air (i.e., no wind), AoA is the difference between the flight path angle and the pitch attitude (angle), assuming no wind (Cashman, Kelly, and Nield, 2005).

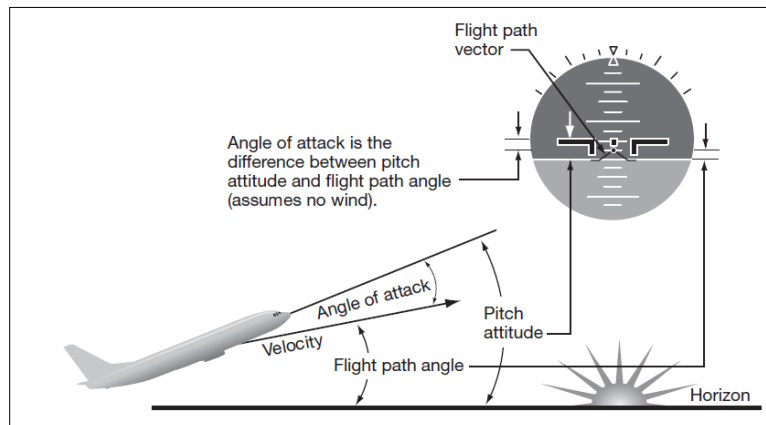

Figure 2: Angle-of-Attack, Flight Path Angle and Pitch attitude (Upset Recovery Industry Team, 2008)

A typical wing has a range of AoA over which it can function efficiently. With a typical cambered wing design, there is a small amount of lift at zero degrees of AoA (Figure 3). As the AoA increases, lift increases, until the air flowing over the wing will eventually separate from the upper surface, resulting in a loss of lift, or a stall. This stall condition can occur at any airspeed, altitude, or attitude (Figure 4), but will always occur at the critical angle of attack. Therefore, knowing when the wing is approaching this critical AoA is an important element of aircraft energy state awareness (Upset Recovery Industry Team, 2008).

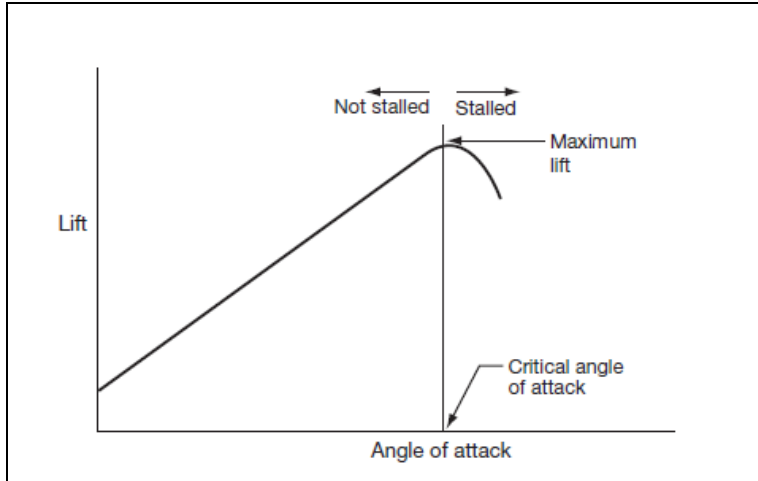

Figure 3: Lift at Angle of Attack (Upset Recovery Industry Team, 2008)

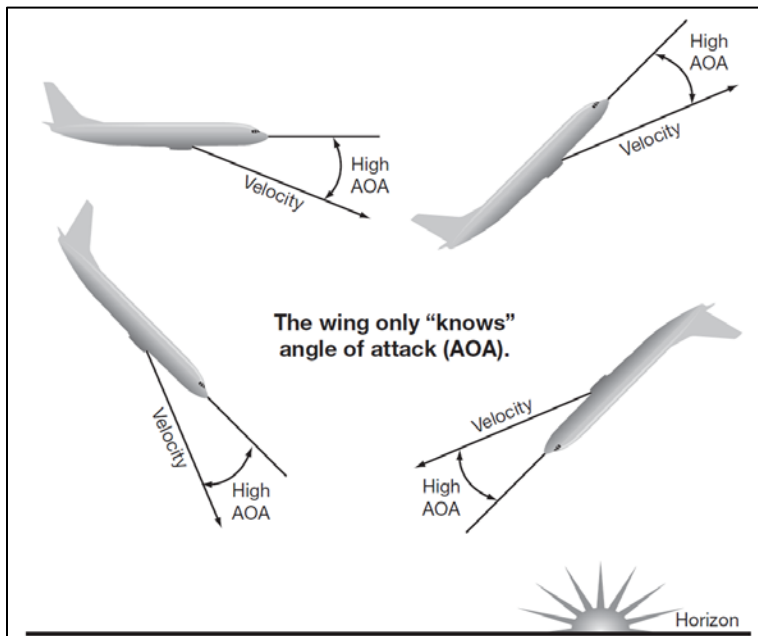

Figure 4: Different Pitch Attitudes and Stall AoA (Upset Recovery Industry Team, 2008)

3. Historical Research

The idea that usable AoA information can be gathered from a display already in the cockpit has persisted over the years. Cockpit displays, such as the stall margin on the airspeed tape and the pitch limit indicator on the primary attitude display, show AoA implicitly in the cockpit. Since AoA is a parameter that can't be sensed by pilots (Tucker and Gordon, 1959; Karayanakis, 1982), displayed AoA is beginning to be considered a valuable piece of information needed for many situations during flight; especially resolving upset recovery situations and detecting air data system failures. The following is a historical review of the studies done on AoA displays.

Svimonoff (1958) introduced the United States Air Force (USAF) Advanced Flight Instrument Panel that included an AoA indicator. This report detailed the evaluation of this system by various military, airframe and equipment test pilots as well as the implementation and recommended improvements of the overall system. At the time, AoA was an entirely new control parameter being displayed to the pilots. The large scale used on the indicator and the unstable characteristics during turbulence hindered the pilot's ability to develop a technique or use for the information presented. The AoA indicator developed for the test was only shown during the useful and well defined phases of flight: final approach, cruise and stall. No training on the use of the AoA indicator was given to the pilots beforehand. Pilots originally thought the AoA indicators were useless, but as they became familiar with and learned how to incorporate the information better, they understood the benefits and the resistance to the indicators subsided. The designers found that reducing the original scale factor of the AoA indicator and fixing the unreliable characteristics of the indicator in turbulent air helped increase acceptance and understanding by the pilots. There was a suggestion for further investigation on requirements for the display of AoA, as well as a training program that would allow pilots to take full advantage of the information.

Several other studies were done to test and judge the efficacy of AoA indicators. During flight studies to determine potential operating problems for the future of jet transports, Fishel, Butchart, Glenn, and Robinson (1958) investigated the relationship between 1g stall speed and stall characteristics that occurred during take-off and landing maneuvers. An AoA indicator was installed to give pilots a better indication of the aircraft's attitude during take-off. The pilots discovered that when the AoA indicator was used with other instruments (which the authors did not specify) they were able to achieve an optimal take-off attitude at speeds below the intended take-off speeds. This lessened the large AoAs and increased drag normally attributed to higher take-off speeds and over-rotation, and enabled the pilots to maintain proper aircraft attitude during take-off and climb-out.

Again in 1958, the Second Air Defense Command Safety Symposium (Orr, 1958), discussed flight safety issues in the terminal area and it was recommended that an AoA indicator be added near the airspeed indicator for future deliveries of their aircraft, and installed on the current inventory. This AoA indicator would be used in conjunction with a glideslope indicator to aid in establishing final approach sink rate.

Later, in 1963, during a presentation of ‘lessons learned’ from high speed supersonic transport flight operations, Barton (1963) stated that AoA indicators reduced pilot workload and allowed for more accurate control during the landing phase of flight. This increased control provided an additional margin of safety.

Several studies were done in the late 1960s through the 1970s. A study by Gee, Gaidisic, and Enevoldson (1971) evaluated whether AoA information was a useful addition to the General Aviation cockpit. The pilots, who did not receive any training with the display prior to flying in the experiment and varied widely in their piloting experience, appreciated the ease with which the AoA indicator allowed them to obtain trim and power settings. Piloting tasks that included take-offs, climbs, low speed maneuvers, approaches and landings were evaluated. The study found that an AoA indicator was a desired display to convey margin to stall as well as being a single reference point that allowed the pilot to select an approach trim condition which resulted in consistent flare and float characteristics regardless of weight or flap settings. It was concluded that displaying AoA was valuable during final approach as a way to maintain the flight path to the airport and in maneuvers to flare. Furthermore, it was found to be a desirable control parameter when used in conjunction with airspeed, attitude and other information.

In 1972, a conference was held by the Flight Mechanics Panel to discuss handling qualities criteria of aircraft within the North Atlantic Treaty Organization (NATO) countries. Twenty-one papers were presented and discussed to determine the direction that the panel should take in the future. In the comments section of the paper titled “Criteria for Stall and Post Stall Gyration,” (Lamar, 1972) several commenters mentioned the desire to have an AoA indicator included in the cockpit display and one commenter questioned “if the test pilot of an aircraft needed an angle of attack indicator to stay out of a stall, then shouldn’t every aircraft have one?” Hancock (1972) stated that:

Fundamentally, and it has always been recognized as such, stall is a function of angle of attack, also rate of change of angle of attack, rather than speed. It would be more logical to express the safety margin in terms of angle of attack, especially from the point of view of accounting for atmospheric turbulence effects. However, the use of speed is more convenient and is by now well established; it is understood that the definition of the slow rate of decrease of speed is equivalent to a statement on the slow rate of increase in the angle of attack.

It was further proposed that AoA information would be valuable during the transition flight phase as well as during upsets caused by turbulence (Hancock, 1972).

Odle (1972) tasked with studying and evaluating an AoA system for use in the United States Air Force (USAF) Air Training Command’s flight training program, found that AoA systems were most valuable in preventing stalls during the traffic pattern and landing phase. The study was used to determine which flying maneuvers could be flown using the AoA system and how, using AoA, those maneuvers should be flown. A large majority of the pilots in the study used AoA information and airspeed to control the

aircraft with greater confidence while flying traffic patterns and maneuvers requiring maximum performance. Further research was suggested to better understand other beneficial uses of an AoA indicator. Other studies cited in Karayanakis (1982) found that AoA feedback was useful during flight maneuvers such as: take-off, climb, turns, cruise, slow-flight, descent and landings. The AoA indicator gives the pilot a safe margin to stall that is independent of weight, bank angle, g-forces or density altitude variations.

The Navy evaluated AoA indicators to determine the optimum settings for the phases of flight where it determined it was most beneficial (Carlquist, 1960). They found that an AoA indicator provided useful information during steep turns, while gaining altitude where thrust was limited, maximum endurance flight at steady altitude, ground control approaches, normal field landings in smooth air, and carrier landings. It was impractical to use during cruise since the optimum AoA changed along with altitude, and it was difficult to use during times of turbulence. The AoA indicator was a primary reference during ground control approaches, stall warning, and smooth air landings and it was a secondary reference during other phases of flight. Following this study, it was recommended that AoA systems be installed according to military specifications. For the Navy, using AoA for low-speed control during carrier landings has shown a reduction in stall accidents and high energy landings (Forrest, 1969; Karayanakis, 1982). They also found that implementing the use of AoA on their other aircraft contributed to a substantial reduction in workload by providing a known margin to stall. This knowledge allowed pilots to achieve maximum aircraft performance during flight maneuvers. There was an almost complete elimination of early rotation during takeoff, and aircraft using AoA indicators were able to attain and maintain maximum range and endurance. Furthermore, AoA indicators were used to prevent stalls at high altitudes (above 40,000 feet) during high-g maneuvers. This led to significant improvements of all Navy jet operations. Forrest (1969) also believed that many of these advantages applied to commercial aircraft and anticipated the widespread use of AoA indicators in both jetliners and corporate jets.

Several studies, (Carlquist, 1960; Ellis, 1977; Gee, Gaidisic, and Enevoldson, 1971; Karayanakis 1982) noted that acceptance of AoA indicators varied with exposure. Most pilots have more experience and familiarity with the airspeed indicator and this may have had an influence on the perception of its usability. Pilots who were unfamiliar with AoA indicators needed practice with the instrument and an adjustment period to really understand the benefits. Carlquist (1960) found that acceptance by military pilots was varied due to factors which included: presentation, sensitivity, reliability, environmental conditions, aircraft maintenance procedures, individual pilot training and experience, and squadron policy and procedures.

Many of the previous studies called for further investigation into the actual requirements for an AoA display as well as further studies to better understand the full range of uses and benefits of displaying AoA in the cockpit. Studies of this nature were not found. In fact, research into displaying AoA information directly in the cockpit was primarily conducted prior to the 1980s. The research that was reviewed covered AoA use in

general aviation, military, and early transport aircraft; however, research using current general aviation, military and jet transport aircraft was not found.

4. AoA in the Cockpit

An AoA system contains all the components needed to calculate and display AoA in the cockpit. An AoA system typically contains these four components: sensors, transducers, indicators and stall-warning devices. Sensors can be either vane or probe types (Figure 5) which sense differential pressure through ports. One or more of these sensors are attached to either the wing or the forward fuselage (Figure 6) and sense the relative airflow. Transducers transform the sensor output to create a signal that is sent to the cockpit indicator. This signal can be sent directly or passed through an air data system (MacDonald, 2002). This signal must be corrected for flow effects across the aircraft nose and fuselage, position errors, and Mach number as well as other aerodynamic corrections to create an AoA measure relative to the aircraft wing. For commercial transport aircraft, these corrections can be significant (Cashman, Kelly, and Nield, 2005). AoA indicators include various display methods which may present the information implicitly (e.g., Pitch Limit Indicator, PLI, or ‘barber pole’ airspeed warnings) or explicitly indicating AoA using angles, normalized units, or symbols (e.g., indexers). Finally, stall-warning devices use AoA data to warn of impending stalls. Because AoA is critical for stall and stall margin awareness, the systems typically compute and display the critical AoA (stall AoA). For accuracy this computation must take into account how the critical AoA changes with the aircraft configuration (e.g., gear, flaps, spoilers, etc.), Mach number, and other aerodynamic effects (MacDonald, 2002).

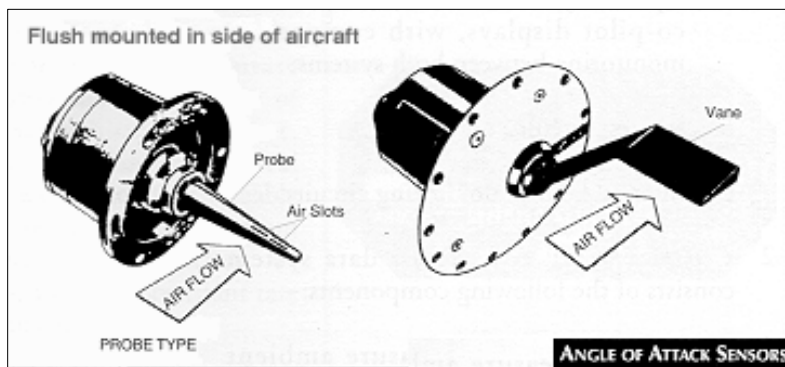

Figure 5: Common AoA Sensor Types (MacDonald, 2002)

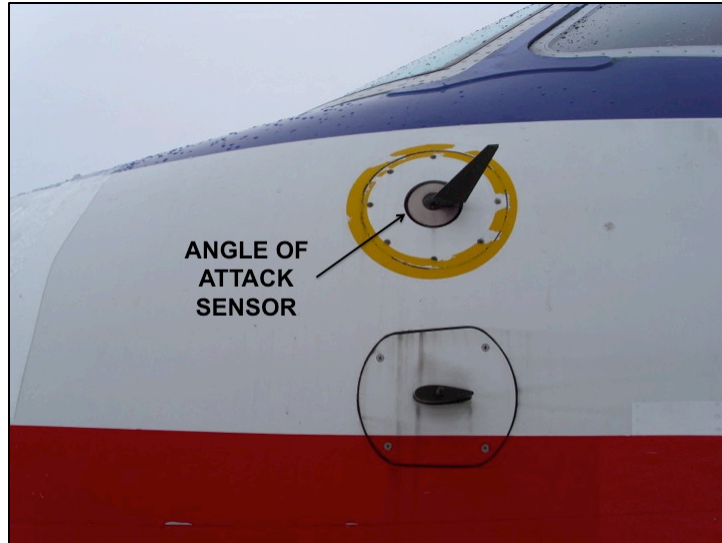

Figure 6: Angle of Attack sensor on Embraer 145 (Schock, 2014)

AoA is displayed in the cockpit in a variety of ways. Examples of AoA displays are taken from previous research as well as current AoA display options used in military, private and commercial aircraft. AoA indicators come in various stand-alone styles: circular/dial, horizontal, or vertical. They are also available on the primary flight display or head-up display as a dial, tape, or as a display of the calculated AoA value. Their size and position vary by manufacturer and aircraft. The scale on the indicator may display AoA in arbitrary units (Figure 7), normalized units (Figure 8), or actual degrees (Figure 9). The dial-type scale not only gives current AoA information, but it can also function as a rate-of-change indicator. This rate-of-change information can give the pilot an awareness of the situation that can keep the aircraft from entering a critical AoA state. AoA indexers, normally found in military aircraft, are also reviewed.

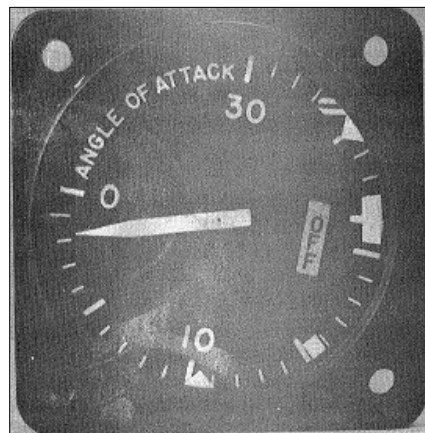

Figure 7: Specialties AoA indicator displaying arbitrary numbers (Carlquist, 1960)



Figure 8: Teledyne Avionics Angle of Attack Indicator (Starfleet Support, LLC, nd)

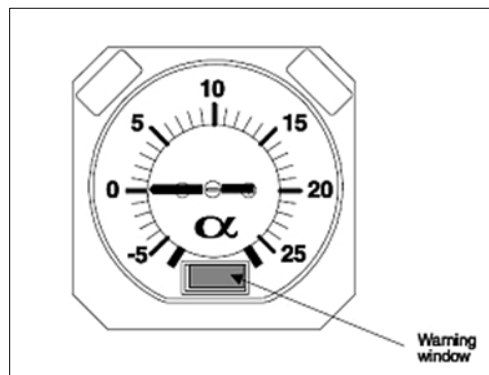

Figure 9: AoA Indicator displaying degree units (Airbus, 1995)

4.1 General Types

Normalized AoA indicators show a series of numbers between 0.0 and 1.0, where 0.6 is an AoA that is approximately 30 percent above margin to stall, taking into account the aircraft's current weight and configuration (Aarons, 2006). Since this stall AoA is dependent upon aircraft configuration, among other things, the normalization factor would need to change if a normalized AoA value of 1.0 is to always indicate the critical AoA. Furthermore, using normalized AoA indicators on commercial jet aircraft would require that the AoA calculation include Mach number which would inhibit the indicator from being used as a cross-check of a possible pitot or static system failure (Cashman, Kelly, and Nield, 2005). Color wedges can be added on a dial indicator to further situation awareness. As an example, a green wedge from 0.0 to 0.6, a yellow wedge from 0.6 to 0.8 and a red wedge from 0.8 to stall. Staying in the green should keep the pilot out of harm's way. The green-yellow border, which is still within the 30 percent margin to stall, is best for low-speed, maximum lift maneuvers that typically occur directly after takeoff or during final approach. At 0.8, the stall warning devices normally activate (Aarons, 2006).

With a non-normalized design, the AoA read-out reflects only the sensed AoA (Figure 10). In a pitot or static failure situation, the marks indicating stall warning, stick shaker and the speed tape bands may act erratically, but the needle and numerical read-out of AoA will remain stable and usable. This also enables non-normalized indicators to be used as a backup for an unreliable airspeed reading (Cashman, Kelly, Nield, 2000).

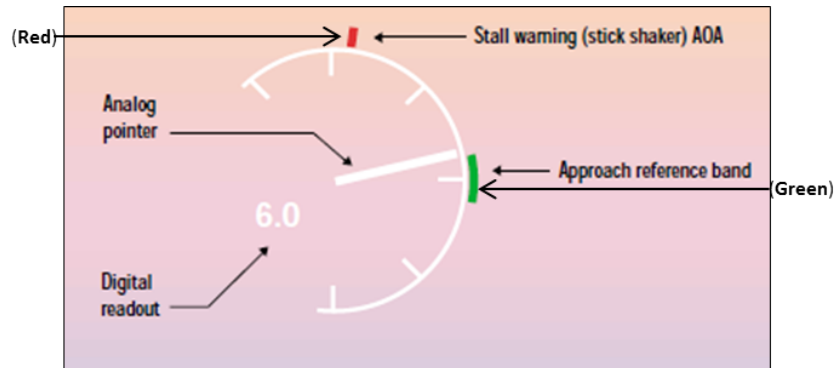

Figure 10: Inset of Boeing AoA Gauge (Cashman, Kelly, Nield, 2000)

Two types of early AoA indicators (not depicted), the Kollsman airspeed/AoA indicator and the Specialties Inc. AoA indicator were evaluated by Tucker and Gordon (1959) at the Air Force Flight Test Center. Thirty-two flights, primarily testing power approach problems, were flown. Secondary considerations included maximum range and endurance, as well as recovering from stalls and engine flame-outs during approach. The Kollsman airspeed/AoA indicator presented AoA indirectly on the airspeed indicator using a “marked ring which travels the circumference of the indicator. Aligning the airspeed needle with the appropriate AoA index, the airplane will be flown at the optimum airspeed for that condition at essentially all the gross weights and bank angles.” (Tucker and Gordon, 1959) Because there were two moving reference points, the information provided was not useable rate information until the aircraft’s airspeed and AoA was close to optimum. The movable reference points also made it unsuitable for measuring closeness to the desired AoA. The presentation allowed the pilots to reference either airspeed or AoA independently. The Specialties, Inc. gauge provided a direct indication of AoA, but it was done in arbitrary units that the pilots had no experience interpreting. Pilots in the Tucker and Gordon (1959) study preferred the Kollsman system over the Specialties, Inc. AoA system. Both indicators were evaluated and while it was discovered that both were good for optimizing cruise, neither was recommended for inclusion into the USAF’s F-106 or F-102 fleet because they were not believed to aid in the approach problems for which they were tested. The study did find that both systems would be useful in the event of a pitot-static system failure.

In a 1960 study looking to determine optimum AoA settings for all applicable phases of flight, the Navy studied two (of which only one system is pictured below) dial-type indicators with a pointer that moved counterclockwise in increasing value of AoA, in units from 0-30 (Figure 11) (Carlquist, 1960). This movement better matched the movement of both the airspeed indicator and aircraft pitch attitude. Three movable index markers rotated within the face. The marker with a hashed area at 25-27 units indicated

the point of the stall warning while the other two movable markers could mark other desired pre-determined values. A fixed marker at the 3 o'clock position marked the optimum approach AoA.

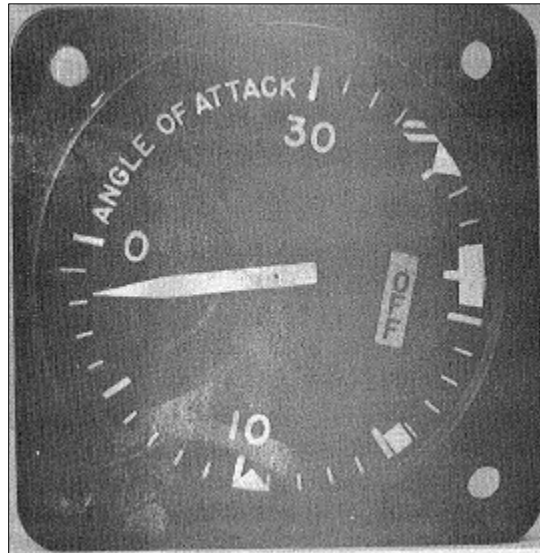

Figure 11: Specialties, Inc. B-2 Dial-type AoA Indicator (Carlquist, 1960)

The study also included an AoA approach index indicator (Figure 12). The center circle was lit to indicate the optimum approach angle and the chevrons lit up to give the direction of correction needed to maintain the optimum approach angle (Carlquist, 1960).

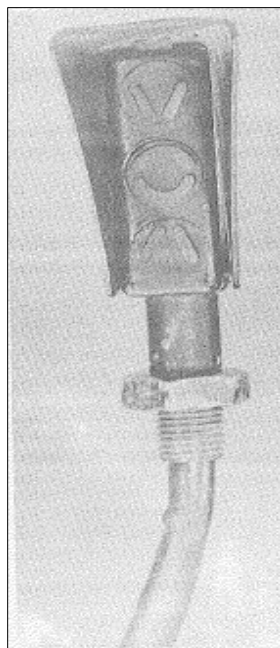

Figure 12: Specialties, Inc. AoA Approach Index Indicator (Carlquist, 1960)

In 1969, Forrest wrote a report for the FAA which studied whether using AoA information as well as other required instruments would “enhance the process of learning

to pilot an airplane”. They found that most of the benefit of using AoA came while flying steep ascent and descent. However, it was determined that AoA displays may be more beneficial to instrument rated pilots, since most beginning pilots use visual cues to fly. The researchers felt that one limitation to their study was the presentation of AoA. Sixty percent of the instructor pilots felt that a different presentation of AoA may have improved its use by the subject pilots during flight. The instrument used was a dial-type indicator that used arbitrary reference units, graduated in thirty units. Certain reference units applied to certain maneuvers, and it was the pilot’s job to know which reference unit correlated to which maneuver. Recommendations for further research into using an AoA indicator in instrument flight training were made since there are many benefits to using AoA that may be better realized at the instrument pilot level (Forrest, 1969).

The AoA indicator used on a twin engine general aviation airplane for a 1971 study conducted by Gee, et al., was a horizontal display, mounted above the instrument panel on the left side of the cockpit (Figure 13), to enable it to be within the pilot’s field-of-view as he looked through the windscreen. The regions were color coded to simplify understanding of the information.

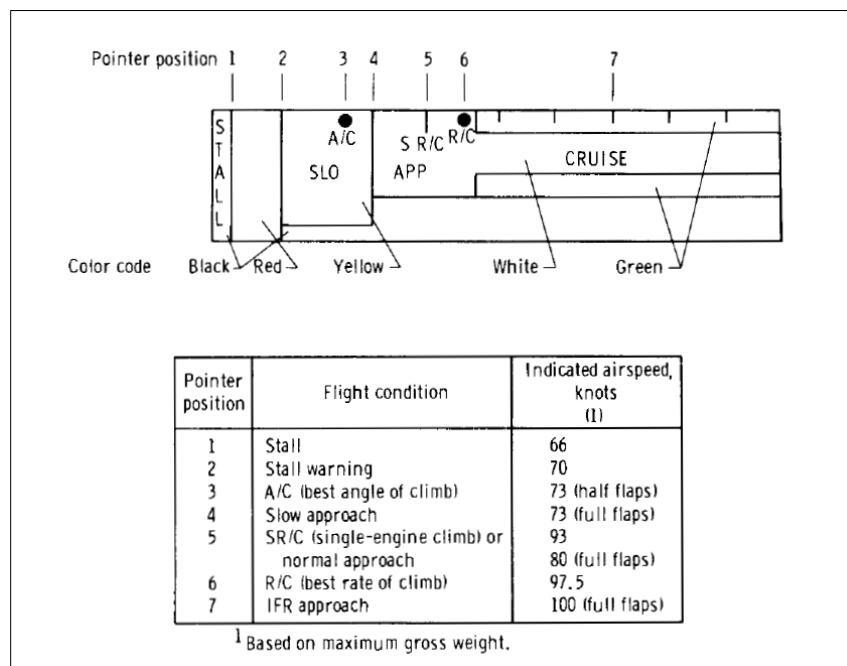

Figure 13: AoA Display and Key (Gee, Gaidisic, and Enevoldson, 1971)

Pilots in Odle’s 1972 study, which looked at AoA use in various flight maneuvers for the USAF’s Air Training Command’s Instrument Flight Center, stated a desire for AoA to be displayed as the percent of lift available. They felt that displaying the percent of lift available led to better understanding and easier application of the AoA information. Additionally, displaying AoA as a percentage of lift available was appropriate and desired due to the fact that when the display read 0.8, the pilots knew that there was 20 percent lift available, whereas when an indicator showing available AoA read 0.8, this corresponded to 20 percent of available AoA left. While similar, the differences are

significant. The pilots felt that displaying AoA as a percentage of lift available was more direct and transferable across aircraft. The study also recommended that a standardization of AoA displays and symbology across airframes be implemented (Odle, 1972).

For Odle’s (1972) study, a Bendix Standardized AoA System was used that included an AoA indicator and a head-up indexer. The Bendix indicator (not pictured) is a round dial which displayed the percentage of available AoA. The scale ranged from zero lift angle (0) through the stall angle (1.1), where 1.0 represents a stall. The approach index is set at 0.60, while maximum endurance is set at 0.30. The approach to stall is shown with amber coloring and begins at 0.90, while the stall area is shown with red coloring and begins at 1.0 (Odle, 1972).

The head-up indexer (Figure 14) was mounted directly in front of the pilot and used trend information to indicate high, slightly high, on approach, slightly low or low AoA flight information. The indexers were unanimously accepted by the study pilots who found them to be an effective cue of the direction of pitch attitude correction needed to maintain an optimum AoA. Furthermore, it allowed the pilot to fly ‘heads up’ with better aircraft control and more accuracy during the traffic pattern and landing phase (Odle, 1972).







<u>Light</u>	<u>Meaning</u>
 Red	High AOA, low airspeed
 Red	Slightly high AOA, slightly low airspeed
 Green	On approach AOA, on approach speed
 Green	On approach AOA, on approach speed
 Green	Slightly low AOA, slightly high airspeed
 Amber	
 Amber	Low AOA, high airspeed

Figure 14: AoA Indexer (Odle, 1972)

Odle (1972), Egan and Goodson (1978) looked at AoA displays in military aircraft and suggested a standardization of the system and the symbology across the military to reduce confusion and aid in skill and knowledge transfer when switching between different aircraft.

In Ellis’ Light Plane Stall Avoidance and Suppression study (1977), pilots evaluated three styles of AoA indicators: a dial-type indicator with a normalized scale of zero to one, which presented percent of maximum lift available; a vertical indexer with chevrons and a ‘donut’ indicating optimum angle of attack; and a slow-fast meter that was horizontally mounted. It was noted that with familiarity and practice that any of the three styles could be used effectively as an AoA indicator (Ellis, 1977). The study did not mention whether the pilots had any preference towards any particular display style sampled.

4.2 Military AoA Systems

The AoA system for the T-38 (Figure 15) includes a dial indicator for each pilot that displays AoA as a percentage of maximum lift during all phases of flight as well as an AoA indexer which operates and illuminates when the aircraft is configured for landing or when flaps are extended 5 percent or more with the landing gear up (USAF, 1978). The dial is calibrated counterclockwise in increments of 0.1, with each increment from 0 to 1.1, representing approximately 10 percent of aircraft lift. It has two colored arcs, yellow to represent buffet warning and red to represent stall warning. Furthermore, the AoA indicator contained three white indices at 0.18 to denote maximum range, 0.3 to denote maximum endurance, and 0.6 to denote optimum final approach at 1g flight. The indexer will illuminate the chevrons and circle independently or in combination to indicate different AoA conditions such as red for low speed, green for on speed, and yellow for high speed.

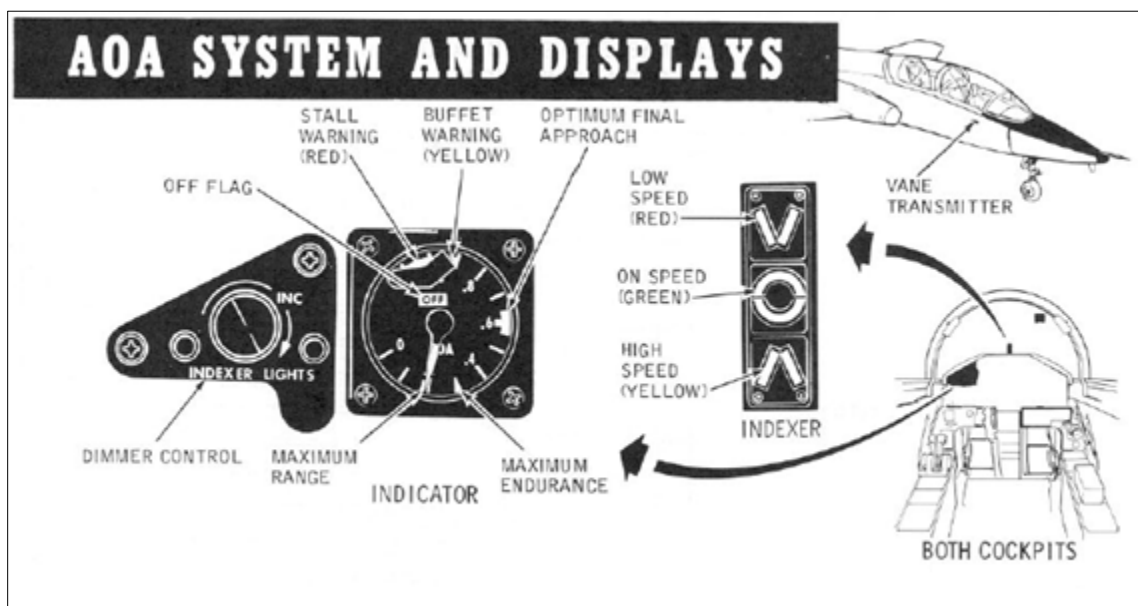

Figure 15: T38 AoA System and Displays (USAF, 1978)

The Navy F/A-18 displays true AoA in degrees in the Head-Up Display (HUD) (Figure 16). When the landing gear is down, an AoA bracket appears. The bracket moves with respect to the velocity vector and the center of this bracket indicates the optimum approach AoA. The pilot also has an AoA indexer mounted to the left of the HUD which operates when the landing gear is down and locked during flight (Figure 17). The chevrons and the circle light up in different combinations to give the pilot a visual indication of the aircraft's airspeed and AoA during landing. The true airspeed and AoA can be referenced on the HUD as described above (United States Navy, 2008).

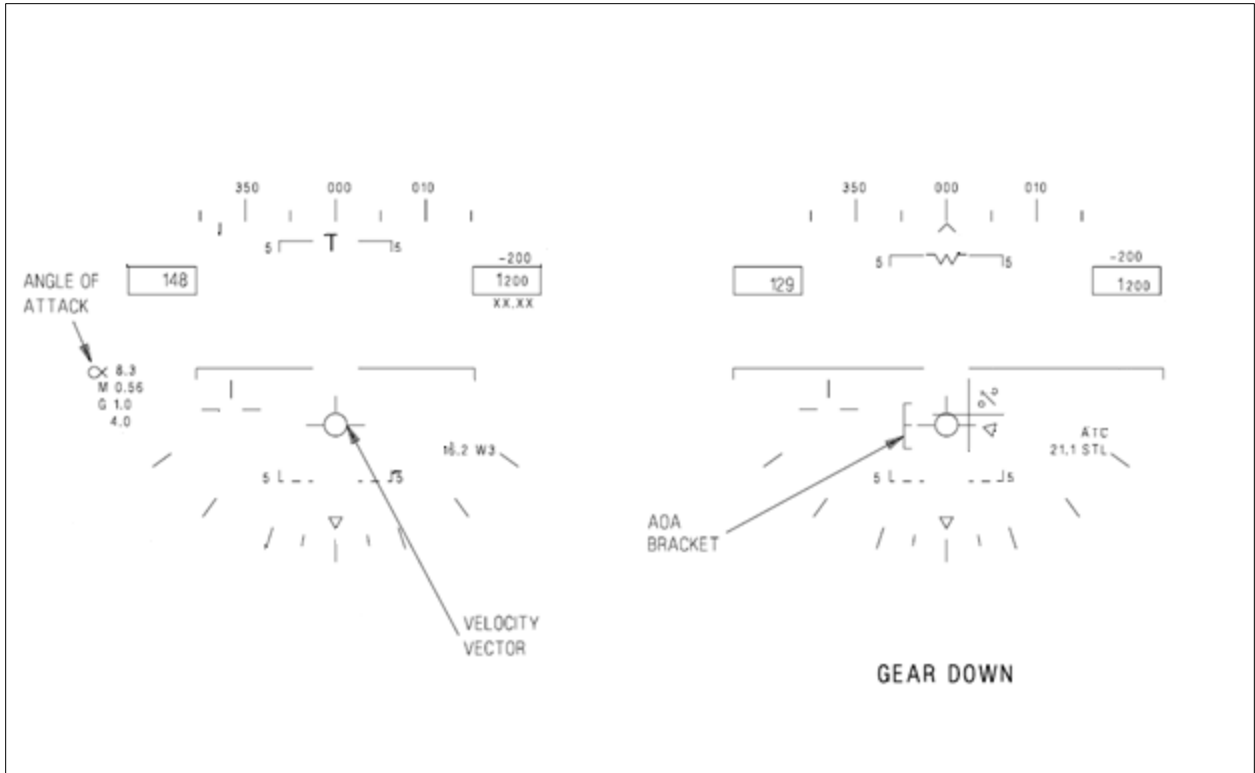

Figure 16: Navy F/A-18 HUD display showing AoA and the AoA Bracket (United States Navy, 2008)

SYMBOL	AIRSPEED	AOA
	SLOW	9.3° TO 90.0°
	SLIGHTLY SLOW	8.8° TO 9.3°
	ON SPEED	7.4° TO 8.8°
	SLIGHTLY FAST	6.9° TO 7.4°
	FAST	0° TO 6.9°

SHADED INDICATES ILLUMINATED

Figure 17: Navy F/A-18 AoA Indexer (United States Navy, 2008)

The F-16 AoA system (United States Air Force, 2002) consists of an indicator located on the instrument panel, an indexer located on the top left side of the glareshield and the HUD AoA display (Figure 18). The AoA indicator displays AoA in true degrees on a vertically moving tape indicating -5 to +32 degrees. Color coding from 9 to 17 degrees corresponds to the color coding on the AoA indexer. The AoA indexer provides a visual indication of aircraft AoA by illuminating either one of the chevrons or the circle. The indexer operates continuously with the landing gear handle up or down. The HUD display uses an AoA bracket when the landing gear is lowered. When the flightpath marker is even with the top of the bracket, the AoA of the aircraft is 11 degrees. When the flightpath marker is in the middle of the bracket, the AoA of the aircraft is 13 degrees and when the flight path marker is even with the bottom of the bracket, the AoA of the aircraft is 15 degrees.







INDICATOR	INDEXER	HUD DISPLAY	ATTITUDE
 15	(RED) 		 SLOW HIGH AOA
 13	(GREEN) 		 ON SPEED OPTIMUM AOA
 11	(AMBER) 		 FAST LOW AOA

Figure 18: F-16 AoA Display System (United States Air Force, 2002)

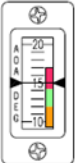
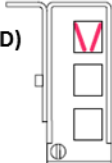
4.3 Commercial Transport and Business Aircraft AoA Indicators

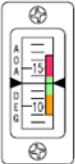
Cessna offers an optional AoA indicator and indexer on their Citation X Model 750 (Figure 19). The indicator is standardized from 0 to 1.0, and contains colored arcs (Cessna, year unknown). The green arc, located from 0 to 0.60, represents normal operation. The yellow arc, located between 0.60 and 0.80, represents the area where the aircraft may be approaching the critical AoA. The yellow arc also contains a symbol between 0.55 and 0.65 and represents the optimum landing approach airspeed. The red arc, from 0.80 to 1.0, represents where low speed buffet may occur and if uncorrected, could continue on to a full stall. The stick-shaker activates around 0.83 +/-0.02. This information is valid for all aircraft configurations and weights. The Cessna approach indexer is mounted on the pilot's glareshield and uses three lighted symbols to indicate one of five AoA conditions. When lit, the top chevron, colored red, indicates a high AoA. This chevron points down to indicate that the AoA should be decreased. A slightly

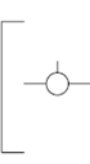
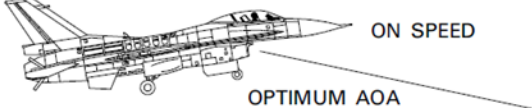
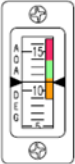
high AoA is indicated when the top chevron and the green circle are lit. Only the green circle lights up when the AoA is on the optimal approach reference. A slightly low AoA is indicated when the circle and bottom chevron, colored yellow, are lit. The bottom chevron lights up when the AoA is low. This chevron points up to indicate that the AoA should be increased.

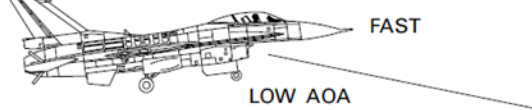
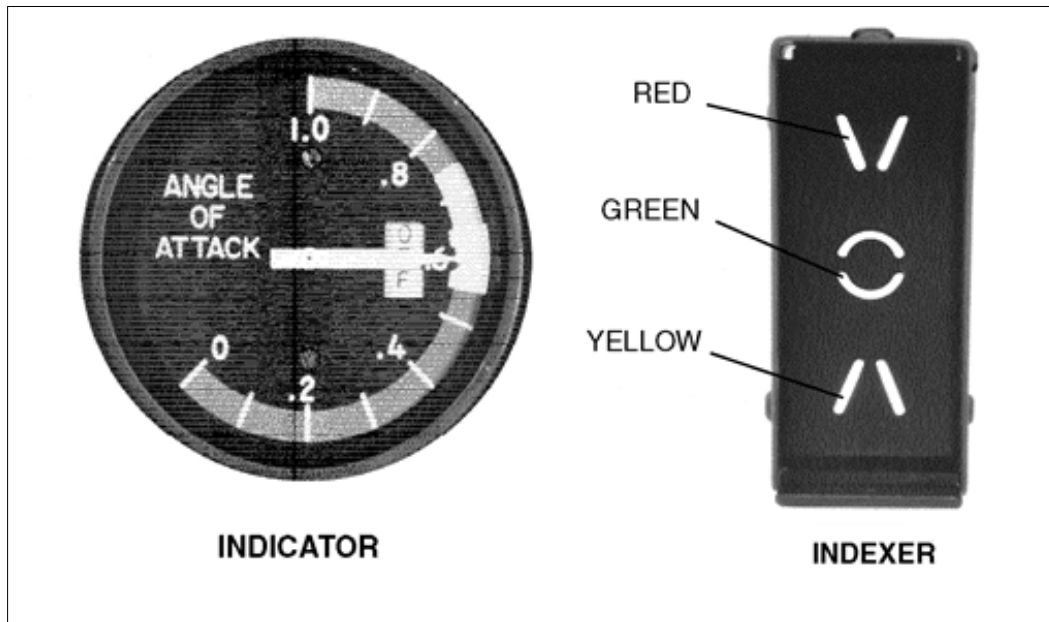

Figure 19: Cessna AoA Indicator and Indexer (Cessna, undated)

Airbus offers an optional AoA indicator on the A340 that provides the crew the true AoA between -5 and +25 degrees (Figure 20). There is an indicator on both the Captain and First Officer side; they are fed directly from the air data inertial reference unit on the corresponding side. In the event of failure of the AoA system, the pointer is positioned at the lower stop and an amber warning flag appears (Airbus, 1995).

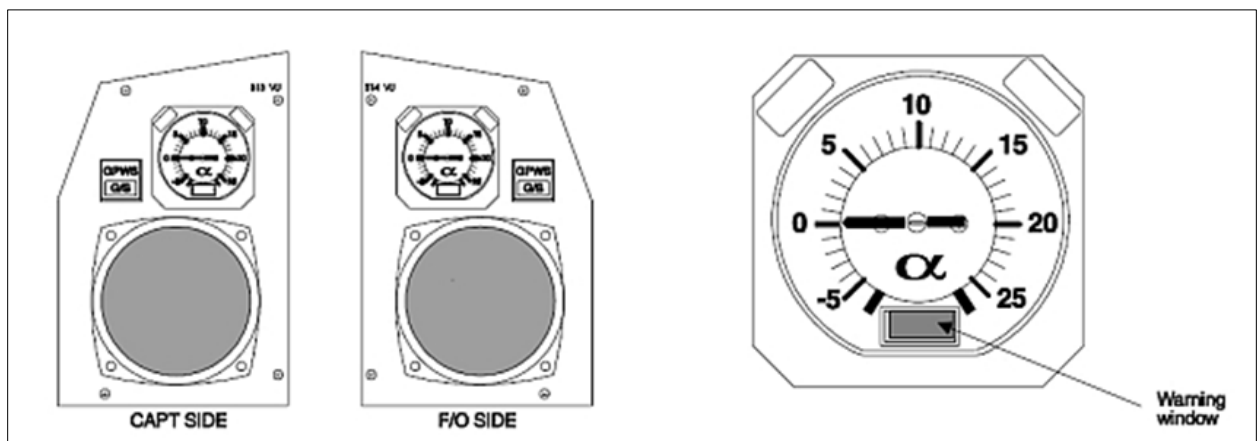

Figure 20: Optional Airbus AoA Indicator (Airbus, 1995)

Boeing offers an optional, non-normalized AoA indicator on its 737-600/-700/-800/-900, 767-400, and 777 flight displays (Figure 21). The indicator combines a digital readout, showing body AoA in degrees, and an analog pointer with a red tick mark indicating the stall warning AoA. In addition, an approach reference band in green is shown whenever landing flaps are being used. Because the displayed value of AoA is non-normalized, it can be used as a backup when there is a suspected pitot or static source blockage or failure. This indicator can also be used to determine margin to stall during upset recovery (Cashman, Kelly & Nield, 2000).

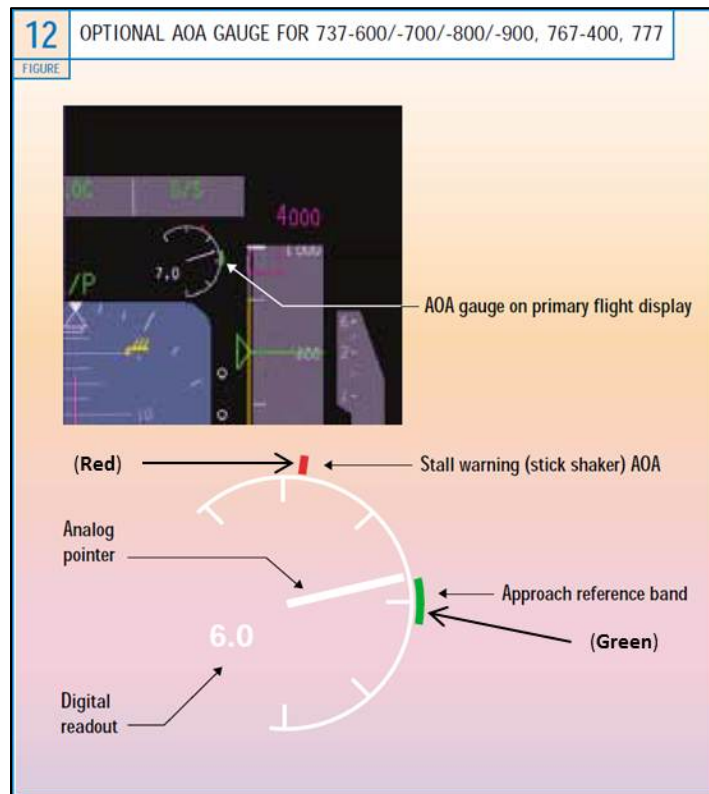

Figure 21: Boeing AoA Gauge (Cashman, Kelly, Nield, 2000)

Other aircraft manufacturers are also offering AoA indicators. Gulfstream displays AoA as a computed, normalized value ranging from 0.00 to 1.10 with 0.00 corresponding to zero lift, while 1.00 is the stick pusher activation threshold. This normalized AoA information is displayed on the primary flight display (PFD) below the airspeed tape (Figure 22). The AoA number can change color from white, during normal operations, to amber for approach to stall, and to red to indicate a stall. When used together with the airspeed tape, pilots can use these as indications of low speed and/or high AoA situations (Gulfstream, 2003).



Figure 22: Gulfstream PFD AoA Located Under Airspeed Tape (Gulfstream, 2003)

4.4 AoA on the HUD

The Rockwell Collins HGS6250 is a Head-up Guidance System that has an AoA indicator (Figure 23) for the HUD. It displays both an analog and a digital readout of AoA. It contains 6 index marks representing from -5 degrees to +20 degrees, and markers that show an approach reference band, a stick-shaker threshold and a maximum lift-over-drag reference (FedEx, 2012).





<p>Angle-of-Attack Scale and Indicator</p> 	<p>The Angle-of-Attack (AOA) Scale and Indicator shows on the upper right side of the Combiner display in a fixed position, and provide an analog and digital indication of the current AOA of the aircraft.</p> <p>The AOA digital value shows in horizontal, small- size numbers displayed within the AOA scale.</p> <p>The AOA Scale includes 6 index marks representing -5 degrees (6 o'clock position) to +20 degrees (10 o'clock position) on the scale.</p> <p>The AOA pointer provides a graphical representation of the current AOA with respect to the AOA scale. The pointer is centered within the scale and rotates counterclockwise for an increasing AOA and clockwise for a decreasing AOA.</p>
<p>AOA Approach Reference Band</p> 	<p>The AOA Approach Reference Band is an empty rectangle that rotates around the AOA Scale to indicate the desired AOA for approach.</p> <p>The Approach Reference Band is displayed when normal or engine-out landing flaps (20, 25, 30) are selected and indicates the appropriate range of approach AOA for $V_{REF}+15$ knots. The band adjusts for each flap position and is approximately 1.5 degrees wide. It is not displayed during takeoff or initial climb.</p>
<p>AOA Stick Shaker Trip Point</p> 	<p>The AOA Stick Shaker Trip Point is an empty triangle that rotates around the AOA Scale to indicate the AOA in which the stick shaker will be activated. AOA Stick Shaker Trip Point appears as the AOA pointer approaches stick shaker AOA (within 3 degrees).</p>
<p>AOA Max L/D Symbol</p> 	<p>The AOA Max Lift/Drag (L/D) symbol is an empty circle with reference to the AOA scale to indicate the AOA Max L/D for a given flight condition. Max L/D is only displayed with a clean wing configuration.</p>

Figure 23: Rockwell Collins HGS6250 AoA Indicator (Fed Ex, 2012)

Another option by Rockwell Collins (Figure 24) shows the approach reference band, (which is variable in accordance with flap settings), and a stick-shaker point which indicates the point at which stick-shaker occurs. The area past the stick-shaker pointer is the “stay-out zone” and is represented by groups of hashed lines (Rockwell Collins, 2002)

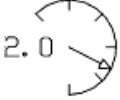
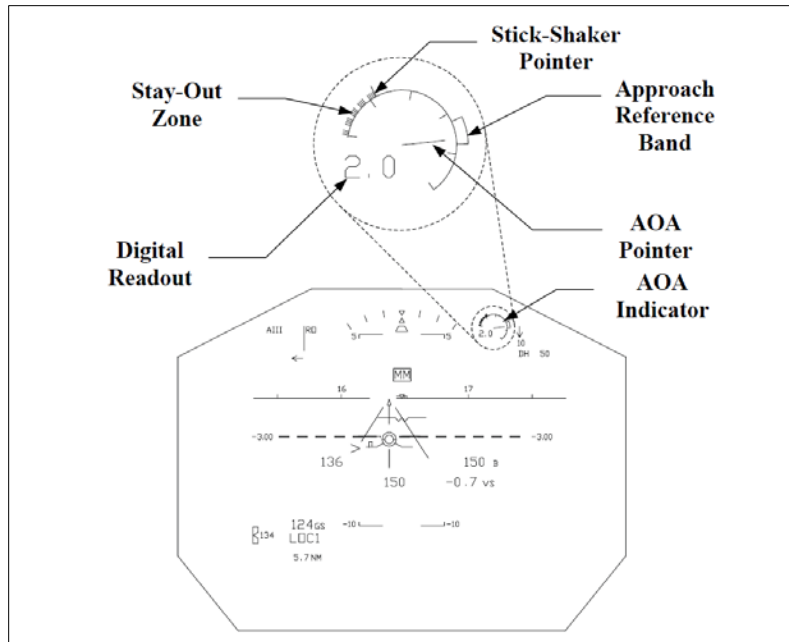

Figure 24: Rockwell Collins HGS4200 AoA Indicator (Rockwell Collins, 2002)

The styles and types of AoA indicators reviewed are diverse and varied. Most of the studies involving AoA indicators sampled only one indicator and did not compare types of indicators. In those that sampled more than one type, there was little mention by the researchers of any pilot preferences between those sampled. The following research did mention indicator type/style preferences. Tucker and Gordon (1959) stated that the Kollsman system of presenting AoA indirectly on the airspeed indicator was preferred over the Specialties, Inc. AoA indicator displaying arbitrary units. Sixty percent of the instructor pilots in the FAA report *Angle of Attack Presentation in Pilot Training* (Forrest, 1969) felt that a different presentation, other than displaying arbitrary units matched with certain maneuvers, would have been more beneficial. Another pilot preference mentioned in the literature was that AoA be displayed as a percentage of lift available (Odle, 1972). Many studies suggested designing a standardized AoA display to ease acceptance and understanding across aircraft; further studies into this were not found.

4.5 General Aviation AoA Systems

In May 2013, the FAA Fact Sheet for General Aviation Safety stated that AoA indicators are one of the technologies that have the highest possibility of significantly enhancing safety and reducing fatalities. According to the FAA, an AoA indicator gives the pilot a visual aid during critical phases of flight that helps to prevent Loss of Control. The approval of AoA indicators for GA aircraft has been streamlined by the FAA as the Administration works towards encouraging the retrofitting of the entire GA fleet (FAA, Dugette & Dorr, 2013). American Society for Testing and Materials (ASTM) International has published functional operation and minimum performance requirements for an AoA system in support of this effort (ASTM, 2013). More recently, in February 2014, the FAA released a memorandum that simplified the design and production

approval of AoA systems. Manufacturers, using the functional operation and minimum performance standards published by ASTM International, can apply for FAA approval via a letter certifying that the system meets those standards. This AoA system is a non-required/supplemental system that is to be installed and operated as a stand-alone/independent system. It must not interface with any certificated system (i.e., pitot static, stall warning, etc.) except to draw electrical power needed to run the AoA unit and any sensor or display unit mounting requirements. To keep policy interpretation consistent, the FAA's Chicago Aircraft Certification Office will be the only office to process the manufacturer's application of their AoA system for market (FAA, Dorr & Cory, 2014; FAA, Hemepe & Seipel, 2014).

Several manufactures offer AoA systems for general aviation aircraft. Garmin offers a normalized AoA indicator (Figure 25) which uses a combination of chevrons and colors to enable the pilot to easily understand the information. The green bars on the bottom show the minimum visible AoA and build towards the calibrated AoA approach target, the small green circle. Increasing the AoA beyond the target is indicated by yellow bars and further by yellow chevrons pointing down. If the AoA increases and exceeds the critical AoA, red chevrons, pointing down, illuminate and begin to flash. There is also an audible alert that begins to beep once the first red chevron is illuminated and increases in intensity and speed until it reaches a constant tone as the top chevron illuminates and flashes, indicating a stall condition (Garmin, 2014).

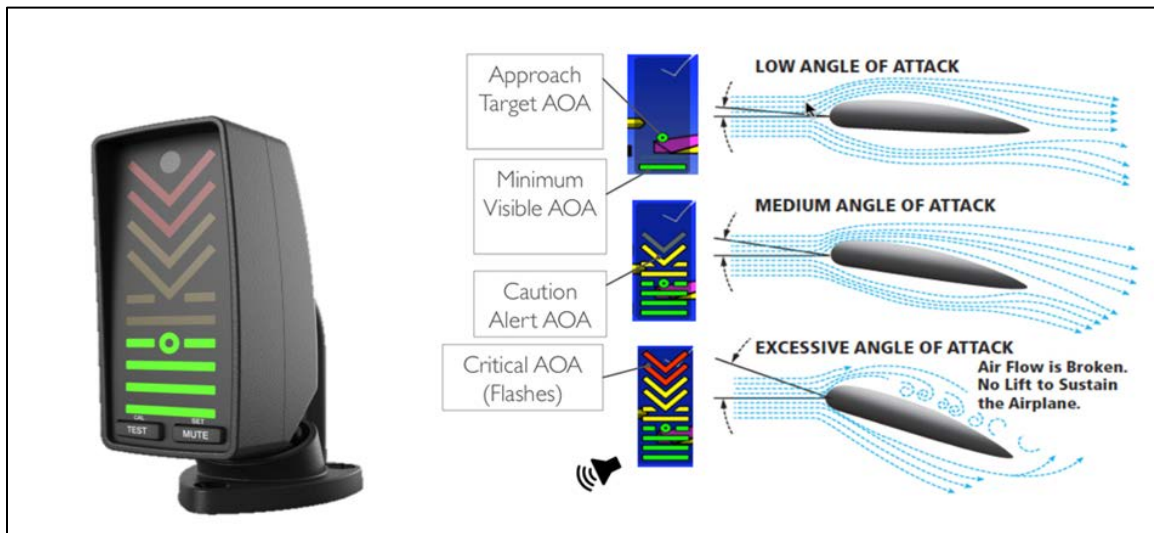

Figure 25: Garmin GI 260 Angle of Attack Indicator (Garmin, 2014)

Garmin also offers the same AoA indicator displayed on the PFD using the above color and audio features (Figure 26).

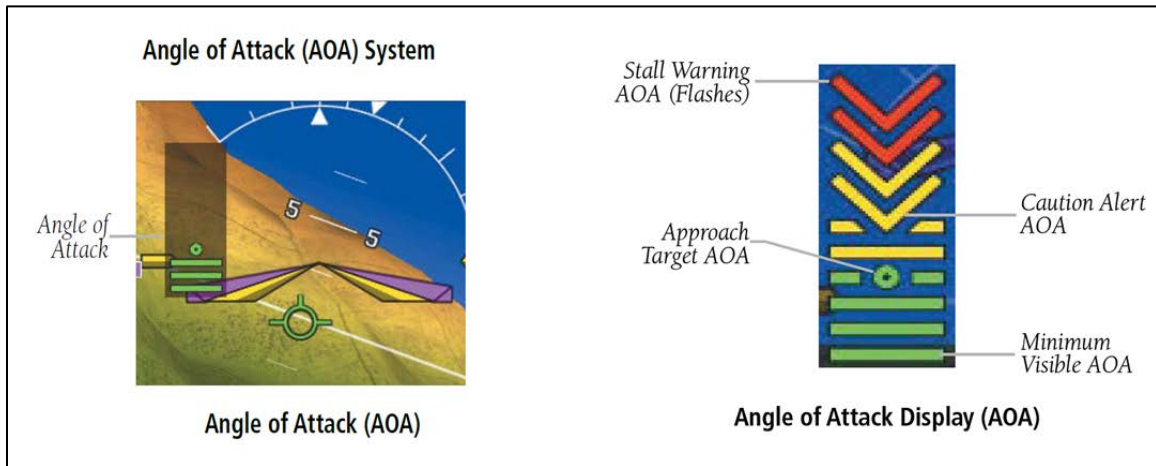

Figure 26: Garmin G3X AoA System (Garmin, 2014)

Alpha Systems has a chevron Style AoA display (Figure 27) that will display a green bar to indicate normal operations for cruise and that AoA is low, and no action is required. A blue donut lights up to indicate “Optimum Alpha Angle” which is a 30 percent margin above stall. A yellow chevron lights up indicating a relatively high AoA and the need to take action to reduce AoA. And finally, a red chevron indicates an AoA that is too high; immediate action is required to reduce the AoA and stall recovery procedures should be performed. The display also has sixteen different brightness levels and four different audio options. Each AoA display is calibrated to the aircrafts specific lift curve (Alpha Systems, 2014).



Figure 27: Alpha System AoA Griffin Chevron Display (Alpha Systems, 2014)

ICON Aircraft offers an AoA system on its A5 Light Sport Aircraft (Figure 28) that is currently in production. It is an analog display that gives graphical information about how much lift is available from the wing before it stalls. The indicator uses green, yellow, and red sectors to give a direct indication of the performance of the wing in real time (ICON, 2013).



Figure 28: ICON A5 Light Sport Aircraft AoA indicator (ICON, 2013)

These examples are just a sampling of the many different types of General Aviation AoA indicators currently on the market. This was not meant to be a complete list and peer-reviewed research was not found on any current AoA indicators on the market.

5. AoA Display Benefits

5.1 Energy State Awareness/Upset Recovery

During low speed conditions and/or upset recovery situations, presenting a visual cue of AoA information in the cockpit can allow the pilot to gather independent verification of how the wing is flying and whether the aircraft's AoA is increasing, decreasing or holding steady. This information may be useful when a pilot is disoriented and cannot trust vestibular cues or their own seat-of-the-pants intuition (Ellis, 1977; Langdon, 1969; Odle, 1972). The literature is reviewed to evaluate evidence that the display of AoA in the cockpit has been useful for energy awareness, stall awareness, and stall and upset recovery.

AC 120-09 from the FAA (2012) states that any transport category airplane must have one or more natural or synthetic indications of an approach to stall. These may include: *aerodynamic buffeting (some airplanes will buffet more than others), reduced roll stability and aileron effectiveness, visual or aural cues and warnings, reduced elevator (pitch) authority, inability to maintain altitude or arrest rate of descent, and/or stick shaker activation (if installed)* (FAA, 2012).

AoA information may drive one or several of these indications and the visual display of AoA may complement the stall warning systems already in place. Binary stall warning systems (i.e., stall horns, stick shakers) provide a fixed margin to stall. These systems typically do not provide information leading up to that activation, nor does it provide information between the stall warning and the aerodynamic stall. An airspeed indicator provides information across the entire range of the flight envelope, but is only accurate for stall prediction in un-accelerated flight. An AoA indicator provides information across the same flight envelope range as an airspeed indicator, but remains accurate under accelerated G loads. The AOA indicator can keep the pilot from entering into a situation where binary stall warning systems activate and can also provide information between the warning activation and actual aerodynamic stall, depending on the format and resolution of the display. An AoA indicator adds a margin of safety to low speed maneuvers by providing information about how the wing is flying and enables the pilot to keep the aircraft in the air. For example, when flying a holding pattern, an increase in AoA can be an indication of wing icing. The extra wing loading due to turns at low speed can induce a stall quickly, even on a "clean" wing (Air Safety Week, 1999).

When stall warning systems are misunderstood, as in Air France Flight 447 (Bureau d'Enquêtes et d'Analyses, 2012), an AoA indicator can be a single point of reference where the pilot can see the margin to stall and determine whether the aircraft is in a stall. An AoA indicator would have given the pilot knowledge of how the wing was flying. This knowledge can be crucial in the first few seconds of an emergency and can give vital information that assists the pilot in recovering the aircraft. In Air France 447, the accident report noted that the crew inadvertently entered an upset situation after an autopilot disconnect. The destabilization of the flight resulted in a sustained stall, which the crew never formally identified or recovered from. The instantaneous feedback of an AoA indicator can give the pilot key information quickly that can be used to assess the

flight condition and keep the aircraft in the air. This information may allow better comprehension of what is happening which can increase their situation and energy state awareness (Ellis, 1977).

While pitch attitude - the angle between the aircraft body reference and the horizon - can typically be recognized by pilots, this is not the case when pilots attempt to determine AoA. Trubshaw, as quoted in Karayanakis (1982) believes that, from the pilot's standpoint, the rate of change of AoA while approaching a stall is a significant piece of information that should be displayed. Furthermore, Hancock (1972) stated that a pilot can believe that the aircraft has recovered from a stall, based on pitch attitude, their vestibular system and/or other clues, but still be at a critical AoA which can lead to a secondary stall.

AoA information can give the pilot the ability to reliably use the aircraft's maximum climb performance, which is necessary to effectively travel through severe wind shear. However, this is rarely directly displayed in the cockpit. Therefore, in a 1983 report it was suggested that AoA indicators be installed as part of the cockpit instrumentation displayed to the pilot. These indicators are considered to be "simple instruments" that can accurately inform a pilot how best to fly their aircraft (Townsend, 1983).

The investigation of a fatal December 1995 accident of American Airlines Flight 965 in Cali, Columbia found that after the Ground Proximity Warning System sounded, the first officer repeatedly increased pitch attitude until the stick-shaker activated and then reduced pitch until the stick-shaker warning ended. The first officer may have been using the stick-shaker activation as an indication of the aircraft's maximum AoA that would enable him to gain the maximum available thrust and altitude. Without an actual AoA indicator, the pilot could not keep the pitch attitude in the stick-shaker region because he had no idea how much lift was still available or how close the aircraft was to a stall. The report showed that if he had held the AoA at stick-shaker activation steadily during his recovery, the aircraft may have cleared the first collision site (NTSB, 1996). As a result of these findings, the National Transportation Safety Board (NTSB) issued Safety Recommendation A-96-094. It reads:

TO THE FEDERAL AVIATION ADMINISTRATION (FAA): Require that all transport-category aircraft present pilots with angle-of-attack info in a visual format, and that all air carriers train their pilots to use the info to obtain maximum possible airplane climb performance. (NTSB, 1996)

This recommendation was reiterated again after a fatal December 1996 accident of an Airborne Express DC-8 in Narrows, Virginia. In this report the NTSB also states that "a display of angle of attack on the flight deck would have maintained the flightcrew's awareness of the stall condition and it would have provided direct indication of the pitch attitudes required for recovery throughout the attempted stall recovery sequence." The NTSB also believed that the accident may have been prevented if a direct indication of AoA was presented to the flightcrew (NTSB, 1997).

The FAA evaluated the NTSB's recommendation A-96-094 and found that using ground proximity warning systems would reduce the occurrence of ground proximity escape maneuvers by enabling the pilot to determine a terrain threat well before any maximum climb maneuver would be needed. The NTSB mentioned in a later response to the FAA that there were several other scenarios where AoA information would have been beneficial to the flightcrew. These included erroneous airspeed, blocked static ports, and improperly entered fuel weight. The FAA believed that these scenarios and the accidents they caused were not related to the original need for maximum climb performance, but instead could be addressed without requiring AoA indicators. The FAA further stated that pilots can reference the predetermined pitch and power settings to accomplish continued flight and landing in such incidents. The NTSB stated in 2001 that an AoA indicator is a single point of reference that gives a quick indication of the margin to stall and is more accessible than the charts providing recommended pitch and power setting for each scenario (NTSB, 2001). While the issues brought up in the discussion between the NTSB and the FAA have been addressed by incorporating terrain avoidance systems and better defined procedures and training in those systems, there is still a missing component, one that may improve all of the systems already in use, a cockpit display of AoA.

Ellis (1977), Langdon (1969) and Odle (1972) believed using AoA in low speed situations may be useful as an aid to upset recovery. The aircraft incidents described above are included as they contain recommendations that may prevent those same situations from happening again. Current studies researching the use of AoA indicators as an aid in airplane energy state awareness or upset recovery were not found.

5.2 Detect/Diagnose Air Data System Failures

An AoA indicator may be effective as an additional independent or redundant information source in the event of a pitot static system failure. AoA may be a useable indication of airspeed during recovery as both airspeed and AoA offer the same accuracy in low speed operations (Carlquist, 1960; Odle, 1972). The literature is reviewed to assess the efficacy of AoA in detection, diagnosis, or recovery in the event of air data system failures.

In 1996, both a Birgenair 757 and an AeroPeru 757 crashed due to blocked pitot systems. In these accidents, the airspeed and altitude indicators gave conflicting and erroneous readings and the pilots were without a secondary system to use as a cross check. An AoA indicator could be used to detect and diagnose air data system failures. In the event of pitot tube blockage, an AoA indicator can serve as a secondary source of information to confirm the suspected issue and prevent an inadvertent loss of control, thereby assisting the pilot in keeping the aircraft in the air. (Air Safety Week, 1999).

Following an incident involving a UPS 747-200 freighter with unreliable readings of both altitude and airspeed, due to open static port drain lines, UPS asked that their response be included in the final report of the Irish Air Accident Investigation Unit (AAIU). It is as follows:

An additional option that should be addressed is the inclusion of an Angle of Attack (AoA) presentation in the cockpit. The AoA provides immediate reference for stall protection in the event that there is a failure of both airspeed indicators. The information presented by the AoA is immediate and continuous as opposed to the task of referencing charts in manuals. It is also more accurate than using Target Pitch and Thrust Settings. Additionally, in cases where the Captain's and the First Officer's airspeed indicators do not agree, the AoA would provide a reference source to the flight crew to help determine which airspeed indicator is reading correctly (AIUU, 2000).

The AIUU's lead investigator for the case, Graham Liddy, stated that an AoA indicator is a single point of reference that is simple and easier than looking for pitch and thrust information from books and graphics during an emerging situation. Having AoA information readily accessible can keep the crews from becoming distracted and allow for a quicker diagnosis and recovery (Air Safety Week, 2004).

As part of its investigation into the Air France accident of Flight 447 on June 1, 2009, due to blocked pitot tubes, the Bureau d'Enquêtes et d'Analyses (BEA) stated that "only a direct readout of the angle of attack could enable crews to rapidly identify the aerodynamic situation of the aeroplane and take actions that may be required." (Bureau d'Enquêtes et d'Analyses, 2012) One of the many factors that are believed to be a contributing cause of this accident is the crew not identifying or reacting to the stall warning. This may be because of a combination of factors, one of which is that there was not any visual indication available to confirm the approach to stall given by the aural stall warning (Bureau d'Enquêtes et d'Analyses, 2012).

Most of the recommendations for using AoA indicators as a backup for pitot static system failure were written in response to incidents that occurred. Current research into the use of AoA as a verification for pitot static system failure was not found.

6. Training

The display of AoA as discussed in Section 2 has been shown to provide beneficial information to the flight crew. As part of the cost-benefit trade-off, the question of the training and proficiency requirements for various indicators must be considered. In this section, the literature was reviewed to identify training provided prior to the various research studies and any remarks about either provided or suggested training.

In some of the studies reviewed, little to no training was given to pilots before using the AoA indicators (Gordon & Tucker, 1959; Ellis, 1977). While there was also not any training done for the AoA portion of Svimonoff's 1958 *Air Force Integrated Flight Instrument* report, it was recommended that a training program be created to allow the Air Force to take full advantage of the new AoA system (Svimonoff, 1958).

Forrest (1969) studied the impact of presenting AoA instrumentation training during initial private pilot training. He also looked into determining when to present AoA during instruction so that it would have the biggest impact on learning. This study was carried out in the initial phases of flight instruction and ground school for student pilots. Training for both groups was identical except the experimental group's instruction contained the addition of AoA indicator instruction. Of the ten instructors, seven felt that incorporation of an AoA indicator during commercial and instrument training would improve the attainment of pilot skills enough to warrant installing an AoA indicator in general aviation aircraft. It was found that some of the student pilots in the experimental group seemed, at times, confused by the AoA indicator. The original idea that incorporating an AoA indicator into pilot training would simplify the process of learning to fly was only accomplished once the student pilot had enough knowledge to properly utilize the instrument. Once this occurred, the experimental pilot group obtained an 8.32% increase in their final check ride performance over the 20 hour check ride scores, while the control group only achieved a 1.54% increase in their performance. Some flight instructors and examiners involved in the study offered the opinion that teaching the use of an AoA indicator during instrument flight training would better utilize the full potential of the indicator. The study concluded that there was no significant difference in flying performance or apparent maneuvering skills between those students trained on the use of an AoA indicator and those trained without. This led to the recommendation that there be no further consideration given to adding AoA training at the private pilot level. There was a suggestion that a project be considered to determine the advantage of adding AoA indicator training during instrument flight training.

In Gee, Gaidstick, and Enevoldson's 1971 evaluation study, no formal training on how to use the provided AoA indicator was given. The safety pilot did direct the participating pilots to develop a technique to use for the study, but each pilot was encouraged to develop his own technique in using the information displayed.

In the 1972 military study to determine which flying maneuvers could be flown using an AoA indicator and how the information should be used during those maneuvers, the test pilots were given a thorough briefing before flight to ensure familiarity with the AoA

system (Odle, 1972). At the conclusion of the study, it was recommended that AoA training be available for instructor pilots at each base as soon as AoA equipped aircraft became available. Furthermore, it was recommended that a training film be made detailing the procedures, techniques, and uses and of an AoA indicator in the cockpit.

Boeing (Cashman, Kelly, Nield, 2000) stated that using an AoA indicator can be a way to increase understanding of the physics of flight as well as aid in a crew's situation awareness of their aircraft's wing during normal and non-normal flight conditions. While the AoA indicator is considered unambiguous, its use and reliability as a secondary backup indicator is dependent on each individual airline's training scenarios and procedures. Training should focus on emphasizing the use of an AoA indicator as a cross-check/back-up to airspeed and Mach indicators, as well as the understanding that AoA information is most useful during low speed, high AoA flight to aid in stall prevention and upset recovery. Furthermore, the green approach band on the Boeing AoA indicator can be used as a cross-check for configuration, reference speed calculation, and/or gross weight errors. However, staying within this green band during the approach phase of the flight, without taking into consideration the regulatory requirements that lead to normal variations of AoA measurement, can lead to inappropriate approach speeds.

Conclusive studies involving research into whether training on the use of an AoA indicator made a difference in its use was not found. The literature reviewed contained limited information on whether training was given or not, with little description to the type of training offered. Suggestions for training found in Cashman, et al. (2000) provide the only detailed discussion of training needs for large transport airplanes.

7. Concluding Remarks

This work collected and reviewed literature to assess the state-of-the-science with respect to the benefits of using various forms of AoA displays to aid in energy state awareness, upset recovery, and diagnosis of air data system failure. Different styles and types of AoA indicators and displays were discussed with descriptions of each.

AoA indicators have been shown to give pilots more accurate control and knowledge of the aircraft's performance and aerodynamics, which is especially useful as the aircraft approaches a stall. In addition, some studies have shown that AoA indicators are effective in reducing pilot workload. The most beneficial use of an AoA display may be as an aid in upset prevention/recovery situations and the detection of pitot or static system failures. However, definitive works quantifying these benefits were not found. The literature did show that AoA can be a beneficial display and may be used in the following phases of flight: take-off, climb, turning, maximizing cruise, descent, final approach, low speed maneuvers, maneuvers to flare, landing, as well as high g turns, approach to stall, and identifying and recovering from stalls at low and high altitudes. However, definitive works that determine the requirements for an AoA display were not found.

Training was offered in some studies, while others allowed the subject pilots to attain their own techniques for the use of AoA indicators in flight. Definitive works to determine the requirements for training for and with AoA information were not identified in this review. This work concludes with the recommendation that two lines of research be pursued for further investigation of appropriate AoA indicator design and training.

8. Recommendations

Based on the literature review, the benefits of an AoA display have been touted - that is, it can provide a direct indication of the airflow angle relative to the wing, which can be especially beneficial for stall margin awareness, and it may also be useful in detecting air data failures. However, most of the literature concerning the benefits in these areas is conjecture based on the information available from an AoA display and how it may be used by a pilot/crew.

Further, the lack of AoA research since about the late 1970s warrants further studies. In particular, two lines of research are recommended:

- Current research into the display of AoA is needed. Research should be conducted into how to best display AoA and when it should be used during commercial transport aircraft operations. The effectiveness of AoA, or any parameter for that matter, is significantly influenced by where and how the information is presented and how it can be integrated and used in the intended operation.
- Very little data was found on how pilots should be trained to use AoA and how a training program can best transfer its utility and benefits to the users. Future research must also consider the extent of training and training methods for dedicated AoA indicators.

9. References

- (1999, August). Angle of attack displays could enhance safety. *Air Safety Week*, 13 (34).
- (2004, February). In-flight emergency caused by simple maintenance oversight. *Air Safety Week*, 18 (8).
- Aarons, R.N. (2006, April). Using angle-of-attack indicators; it may not be a primary indicator, but its information can be primo. *Business & Commercial Aviation*, 98 (4), 46-48. Retrieved from <http://www.safeflight.com/upload/AoA%20article%20B&CA%20April%202006.pdf>
- Air Accident Investigation Unit. (2004). *Final Report: AIUU Report No. 2004-004*. Dublin, Ireland. Retrieved from http://www.aaiu.ie/sites/default/files/upload/general/12850-REPORT_2004_004-0.PDF
- Airbus Industrie Training & Flight Operations Support Division. (1995). *A340 technical training manual*, mechanics/electrics & avionics course, navigation. Retrieved from <http://takata1940.free.fr/aoa1.jpg>, <http://takata1940.free.fr/aoa2.jpg>, and <http://takata1940.free.fr/aoa3.jpg>
- Alpha Systems. (2014). *Griffin Installation Manual* P# AOA-9050-Griffin. (IOM-Griffin, Rev. A). Retrieved from <http://www.alphasystemsaoa.com/assets/PDFs/Griffin%20Installation%20Manual%20revA.pdf>
- ASTM International. (2013). *Standard specification for performance of angle of attack system*, F3011-13. West Conshohocken, PA. Retrieved from <http://www.astm.org>
- Aviation Safety Boeing Commercial Airplanes. (2013, August). *Statistical summary of commercial jet airplane accidents, worldwide operations, 2003-2012*. Retrieved from <http://www.boeing.com/news/techissues/pdf/statsum.pdf>
- Barton, J.A. (1963) Implementing safety lessons learned from high speed flight operations to the supersonic transport, *Flight Safety Foundation International Air Safety Seminar*. Dallas, TX.
- Bureau d'Enquêtes et d'Analyses (BEA). (2012). *Final report on the accident on 1st June 2009 to the Airbus A330-203, registered F-GZCP, operated by Air France*. Retrieved from <http://www.bea.aero/docspa/2009/f-cp090601.en/pdf/f-cp090601.en.pdf>
- Carlquist, R. (1960). *Recommended angle of attack setting for various flight maneuvers; Report #1, final report*. Naval Air Test Center, Patuxent River, Maryland.

- Cashman, J.E., Kelly, B.D., and Nield, B.N. (2000). Operational use of angle of attack on modern commercial jet airplanes. Boeing Commercial Aircraft Company. *Aero Magazine*, (4).
- Cessna. (undated). FAA approved airplane flight manual supplement for Cessna Citation-X series airplane. *Cessna Citation X Model 750, Section 3: Instrumentation and Avionics* (Document 750MA-00).
- Dorr, L., and Cory, E. I. (2014). *FAA clears path for installation of angle of attack indicators in small aircraft*. Washington, DC. Federal Aviation Administration. Retrieved from http://www.faa.gov/news/press_releases/news_story.cfm?newsId=15714
- Duguet, A., and Dorr, L. (2013) *Fact sheet - General aviation safety*. Washington, DC. Federal Aviation Administration. Retrieved from http://www.faa.gov/news/fact_sheets/news_story.cfm?newsId=13672
- Egan, D.E., and Goodson, J.E. (1978) *Human factors engineering for head-up displays: A review of military specifications and recommendations for research*. Naval Aerospace Medical Research Laboratory. Pensacola, FL.
- Ellis, D.R. (1977). *A study of lightplane stall avoidance and suppression* (FAA-RD-77-25). Springfield, VA: National Technical Information Service.
- Federal Aviation Administration. (2012). *Stall and stick pusher training*. (AC No: 102-109). Retrieved from http://www.faa.gov/documentLibrary/media/Advisory_Circular/AC%20120-109.pdf
- FedEx. (2012) FAA approved airplane flight manual supplement for Boeing 757-200 series airplane, revision 1. *Boeing 757-200 HUD/EFVS System Airplane Flight Manual (AFM) Supplement STC ST00313BO*, FedEx Document: ER 10-120.
- Fischel, J., Butchart, S.P., Robinson, G.H. (1958) Flight studies of problems pertinent to low-speed operation of jet transports. *NASA Conference on Some Problems Related to Aircraft Operation*. (pp. 61-81). NASA, Langley Field, VA.
- Forrest, F.G. (1969). *Angle of attack presentation in pilot training* (DS-69-6). Federal Aviation Administration. Washington, DC.
- Garmin. (2014). *Garmin GI 260*. [photograph]. Retrieved from <http://www.aircraftspruce.com/catalog/inpages/aoindicator11-12536.php>
- Garmin. (2014). *G3X Touch pilot's guide*. (Document 190-01754-00 Rev. A).

- Gee, S.W., Gaidstick, H.G., and Enevoldson, E.K. (1971) *Flight evaluation of angle of attack as a control parameter in general-aviation aircraft*. (NASA Document No. D-6210). National Aeronautics and Space Administration. Washington, DC.
- Gulfstream. (2003). *G550 Operating Manual, Production Aircraft Systems* (Document: 2A-27-00).
- Hancock, G.J. (1972). Criteria for stall and post stall gyrations. *AGARD Conference Proceedings No. 106 on Handling Qualities Criteria* (pp. 12-1 to 12-10). Technical Editing and Reproduction Ltd. London.
- Hempe, D.W., Seipel, J.D. (2014). Approval of non-required angle of attack (AoA) indicator systems (Memo No.: AIR100-14-PM01). Retrieved from [http://rgl.faa.gov/Regulatory_and_Guidance_Library/rgPolicy.nsf/0/eb0fac0c1641509586257c76005e6274/\\$FILE/AIR100-14-110-PM01.pdf](http://rgl.faa.gov/Regulatory_and_Guidance_Library/rgPolicy.nsf/0/eb0fac0c1641509586257c76005e6274/$FILE/AIR100-14-110-PM01.pdf)
- ICON. (2013, July). *ICON aircraft releases production details on A5's angle of attack system*. Retrieved from http://www.iconaircraft.com/dl/news/pdf/20130722_ICON_Aircraft_A5_Angle_of_Attack_System.pdf
- Karayanakis, N.M. (1982). *Angle-of-attack feedback in manual aircraft control: Piloting techniques and some flight training implications* (Doctoral dissertation). Available from ProQuest Dissertations and Theses database.
- Lamar, W. E. (1972). *Advisory Group for Aerospace Research and Development (AGARD) conference proceedings No. 106 on handling qualities criteria*. Technical Editing and Reproduction Ltd. London.
- Langdon, S.D. (1969) *Fixed wing stability and control theory and flight test techniques* (USNTPS-FTM-No. 103). Naval Air Test Center. Patuxent River, MD.
- MacDonald, S. A. F. (2002). *From the ground up*. New Castle, WA: Aviation Publishers Co., Limited.
- National Transportation Safety Board (1996). *Safety recommendation A-96-90 through -106*. Washington, DC.
- National Transportation Safety Board. (1997). *Safety recommendation A-97-46 through -52*. Washington, DC.
- National Transportation Safety Board. (2001). *Safety recommendation history for A-96-094 FAA*. Washington, DC.
- Odle, M.L. (1972) *ATC angle of attack training* (AD-757 243). National Technical Information Service. U. S. Department of Commerce. Springfield, VA.

- Orr, G.W. (1958). Seminar #1 - Flight safety operation of aircraft in the terminal area. *Report of the Second Air Defense Command Safety Symposium*. Colorado Springs, CO.
- Rockwell Collins. (2002). *HGS pilot guide for the Bombardier CRJ 700, model 4200* (Document: 9701-1153 Revision A).
- Schock, C. (2014). *Angle of Attack sensor on Embraer 145*. [photograph]. Retrieved from http://training.deicinginnovations.com/?page_id=1274
- Starfleet Support, LLC. (2014). *Teledyne Avionics Angle of Attack (AOA) Indicator*. [photograph]. Retrieved from http://starfleetsupport.com/images/Pages/Avionics2/IMG_2417L_AOA.jpg
- Svimonoff, C. (1958). *The Air Force integrated flight instrument panel* (WADC Technical Report 58-431) Arlington, VA: Armed Services Technical Information Agency (ASTIA).
- Townsend Jr., J.W. (1983). *Low-altitude wind shear and its hazard to aviation*. Washington, DC: National Academy Press.
- Tucker, R.C., and Gordon, H.C. (1959). *Evaluation of Kollsman and Specialties Inc. angle of attack presentation* (AFFTC-TN-59-28). Arlington, VA: ASTIA Document Service Center.
- United States Air Force (1978). *T-38A/B flight manual* (T.O. 1T-38A-1).
- United States Air Force. (2002) *F-16C/D flight manual* (T.O GR1F-16CJ-1). Lockheed Martin Corporation.
- United States Navy. (2008) *NATOPS Flight manual Navy model F/A-18E/F 165533 and up aircraft*. (A1-F18EA-NFM-000).
- Upset Recovery Industry Team. (2008). *Airplane upset recovery training aid, revision 2*. Federal Aviation Administration & Airline Industry.

REPORT DOCUMENTATION PAGE

*Form Approved
OMB No. 0704-0188*

The public reporting burden for this collection of information is estimated to average 1 hour per response, including the time for reviewing instructions, searching existing data sources, gathering and maintaining the data needed, and completing and reviewing the collection of information. Send comments regarding this burden estimate or any other aspect of this collection of information, including suggestions for reducing this burden, to Department of Defense, Washington Headquarters Services, Directorate for Information Operations and Reports (0704-0188), 1215 Jefferson Davis Highway, Suite 1204, Arlington, VA 22202-4302. Respondents should be aware that notwithstanding any other provision of law, no person shall be subject to any penalty for failing to comply with a collection of information if it does not display a currently valid OMB control number.
PLEASE DO NOT RETURN YOUR FORM TO THE ABOVE ADDRESS.

1. REPORT DATE (DD-MM-YYYY) 01-08-2014		2. REPORT TYPE Technical Memorandum		3. DATES COVERED (From - To)	
4. TITLE AND SUBTITLE Review of Research On Angle-of-Attack Indicator Effectiveness				5a. CONTRACT NUMBER	
				5b. GRANT NUMBER	
				5c. PROGRAM ELEMENT NUMBER	
6. AUTHOR(S) Le Vie, Lisa R.				5d. PROJECT NUMBER	
				5e. TASK NUMBER	
				5f. WORK UNIT NUMBER 284848.02.03.07.01	
7. PERFORMING ORGANIZATION NAME(S) AND ADDRESS(ES) NASA Langley Research Center Hampton, VA 23681-2199				8. PERFORMING ORGANIZATION REPORT NUMBER L-20361	
9. SPONSORING/MONITORING AGENCY NAME(S) AND ADDRESS(ES) National Aeronautics and Space Administration Washington, DC 20546-0001				10. SPONSOR/MONITOR'S ACRONYM(S) NASA	
				11. SPONSOR/MONITOR'S REPORT NUMBER(S) NASA/TM-2014-218514	
12. DISTRIBUTION/AVAILABILITY STATEMENT Unclassified - Unlimited Subject Category 03 Availability: NASA CASI (443) 757-5802					
13. SUPPLEMENTARY NOTES					
14. ABSTRACT The National Aeronautics and Space Administration (NASA) conducted a literature review to determine the potential benefits of a display of angle-of-attack (AoA) on the flight deck of commercial transport that may aid a pilot in energy state awareness, upset recovery, and/or diagnosis of air data system failure. This literature review encompassed an exhaustive list of references available and includes studies on the benefits of displaying AoA information during all phases of flight. It also contains information and descriptions about various AoA indicators such as dial, vertical and horizontal types as well as AoA displays on the primary flight display and the head up display. Any training given on the use of an AoA indicator during the research studies or experiments is also included for review.					
15. SUBJECT TERMS Air data systems; Angle of attack; Display devices; Systems failure					
16. SECURITY CLASSIFICATION OF:			17. LIMITATION OF ABSTRACT	18. NUMBER OF PAGES	19a. NAME OF RESPONSIBLE PERSON
a. REPORT	b. ABSTRACT	c. THIS PAGE			STI Help Desk (email: help@sti.nasa.gov)
U	U	U	UU	47	19b. TELEPHONE NUMBER (Include area code) (443) 757-5802