

# VENSTAR®

**DIGITAL THERMOSTAT**

**COMMERCIAL MODEL T2050**

7 Day Programmable • Up to 2-heat & 2-cool

# EXPLORER Mini

with  
**Wi-Fi**  
and  
Local API

HEAT  
COOL &  
HEAT  
PUMP



**Owner's Manual  
& Installation  
Instructions**



## CAUTION

Follow the Installation Instructions before proceeding. Set the thermostat mode to “OFF” prior to changing settings in setup or restoring Factory Defaults.

---

### FCC Compliance Statement

This equipment has been tested and found to comply with the limits for an intentional radiator, pursuant to Part 15, subpart C of the FCC rules. These limits are designed to provide reasonable protection against harmful interference in a residential installation. This equipment generates, uses and can radiate radio frequency energy and, if not installed and used in accordance with the instructions, may cause harmful interference in radio communications. However, there is no guarantee that the interference will not occur in a particular installation. If this equipment does cause harmful interference to radio or television reception, which can be determined by turning the equipment off and on, the user is encouraged to try to correct the interference by one or more of the following measures:

- Reorient or relocate the receiving antenna.
- Increase the separation between the equipment and receiver.
- Connect the equipment into an outlet on a circuit different from that of the receiver.
- Consult the dealer or an experienced radio or TV technician for help.

Notice: Only peripherals complying with FCC limits may be attached to this equipment. Operation with noncompliant peripherals or peripherals not recommended by Venstar, is likely to result in interference to radio and TV reception. Changes or modifications to the product, not expressly approved by Venstar could void the user's authority to operate the equipment.

### FCC - INDOOR Mobile Radio Information:

To comply with FCC/IC RF exposure limits for general population / uncontrolled exposure, the antenna(s) used for this transmitter must be installed to provide a separation distance of at least 20 cm from all persons and must not be co-located or operating in conjunction with any other antenna or transmitter.

This Device complies with Industry Canada License-exempt RSS standard(s). Operation is subject to the following two conditions: 1) this device may not cause interference, and 2) this device must accept any interference, including interference that may cause undesired operation of the device.

Under Industry Canada regulations, this radio transmitter may only operate using an antenna of a type and maximum (or lesser) gain approved for the transmitter by Industry Canada. To reduce potential radio interference to other users, the antenna type and its gain should be so chosen that the equivalent isotropically radiated power (e.i.r.p.) is not more than that necessary for successful communication.

*Cet appareil est conforme avec Industrie Canada, exempts de licence standard RSS(s). Son fonctionnement est soumis aux deux conditions suivantes: 1) ce dispositif ne doit pas causer d'interférences, et 2) ce dispositif doit accepter toute interférence, y compris les interférences qui peuvent causer un mauvais fonctionnement de l'appareil.*

*En vertu des règlements d'Industrie Canada, cet émetteur de radio ne peut fonctionner en utilisant une antenne d'un type et maximale (ou moins) Gain approuvé pour l'émetteur par Industrie Canada. Pour réduire les interférences radio potentielles aux autres utilisateurs, le type d'antenne et son gain doivent être choisis afin que la puissance isotrope rayonnée équivalente (PIRE) ne est pas plus de ce qui est nécessaire pour une communication réussie.*

We, Venstar, declare under our sole responsibility that the device to which this declaration relates: Complies with Part 15 of the FCC Rules. Operation is subject to the following two conditions: (1) this device may not cause harmful interference, and (2) this device must accept any interference received, including interference that may cause undesired operation.

---

This Explorer Mini thermostat has the ability to receive updates to its firmware. Periodically firmware updates are released by the manufacturer to add features and/or performance enhancements. This manual was produced reflecting the most current firmware/feature set at the time of publication, firmware rev. 1.0. Firmware releases after rev. 1.0 may not be adequately depicted in this manual. Please refer to the appropriate website or contact your place of purchase to learn about changes to the thermostat after firmware release 1.0.



**Industry  
Canada**

**Industrie  
Canada**

# Table of Contents

<b>Installation Instructions</b> .....	1
<b>Wire Connections</b> .....	2
<b>Thermostat Backplate</b> .....	3
<b>Dip Switch Settings</b> .....	4
<b>Connect to Wi-Fi</b> .....	10
<b>Front Panel</b> .....	13
<b>Display</b> .....	14
<b>Basic Operation</b> .....	16
<b>User Setup</b> .....	17
<b>Backlight Operation</b> .....	19
<b>Setpoint Limits</b> .....	20
<b>Service Filter</b> .....	21
<b>Installer Setup</b> .....	22
<b>Programming a Daily Schedule</b> .....	29
<b>About Advanced Features &amp; Operation</b> .....	31
<b>Turning On The Time Period Program</b> .....	31
<b>Advanced Setup Table</b> .....	35



## **IMPORTANT**

Follow Installation Instructions carefully. Disconnect Power to the Heater/Air Conditioner before removing the old thermostat and installing the new thermostat.

## Glossary of Terms

**Auto-Changeover:** A mode in which the thermostat will turn on the heating or cooling based on room temperature demand.

**Cool Setpoint:** The warmest temperature that the space should rise to before cooling is turned on (without regard to deadband).

**Deadband:** The number of degrees the thermostat will wait, once a setpoint has been reached, before energizing heating or cooling.

**Differential:** The forced temperature difference between the heat setpoint and the cool setpoint.

**Heat Setpoint:** The coolest temperature that the space should drop to before heating is turned on (without regard to deadband).

**Icon:** The word or symbol that appears on the thermostat display.

**Mode:** The current operating condition of the thermostat (i.e. Off, Heat, Cool, Auto, Program On).

**Non-Programmable Thermostat:** A thermostat that does not have the capability of running Time Period Programming.

**Programmable Thermostat:** A thermostat that has the capability of running Time Period Programming.

**Pre-Occupancy Purge:** Fan operation prior to Occupied 1.

**Temperature Swing:** Same as Deadband.

**Time Period Programming:** A program that allows the thermostat to automatically adjust the *heat setpoint* and/or the *cool setpoint* based on the time of the day.

# Installation Instructions

## Remove and Replace the old thermostat

To install the thermostat properly, please follow these step by step instructions. If you are unsure about any of these steps, call a qualified technician for assistance.

- Installation tools: Small flat blade screwdriver, Phillips screwdriver, wire cutters and wire strippers.



- Make sure your Heater/Air Conditioner is working properly before beginning installation of the thermostat.
- Carefully unpack the thermostat. Save the screws, any brackets, and instructions.
- Turn off the power to the Heating/Air Conditioning system at the main fuse panel. Most residential systems have a separate breaker or switch for disconnecting power to the furnace.
- Remove the cover of the old thermostat. If it does not come off easily, check for screws.
- Loosen the screws holding the thermostat base or subbase to the wall and lift away.
- If you have a smart phone handy, take a photo of the wiring for future reference.
- Disconnect the wires from the old thermostat. Tape the ends of the wires as you disconnect them, and mark them with the letter of the terminal for easy reconnection to the new thermostat.
- Keep the old thermostat for reference purposes, until your new thermostat is functioning properly.

# Installation Instructions

## Wire Connections

If the terminal designations on your old thermostat do not match those on the new thermostat, **refer to the chart below or the wiring diagrams that follow.**

Wire from the old thermostat terminal marked	Function	Install on the new thermostat connector marked
G or F	Fan	G
Y1, Y	Cooling	Y1
W1, W	Heating	W1/O/B
Rh, R, M, Vr, A	Power	R
C	Common	C
O/B	Rev. Valve	W1/O/B*
W2	2nd Stage Heat	W2
Ck1	Dry Contact Switch	CK
CKGND	Dry Contact Switch	R

\* O/B is used if your system is a Heat Pump.

# Installation Instructions

## The Explorer Mini Thermostat Backplate

### To remove the thermostat backplate:

Gently separate the display from the base by pulling from the center.

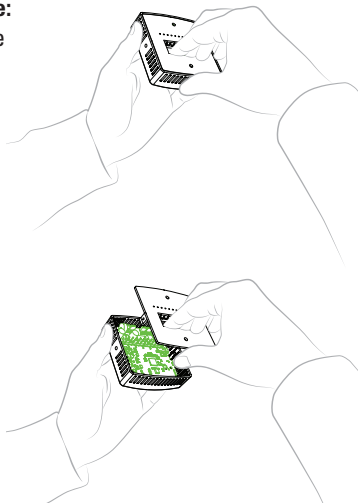
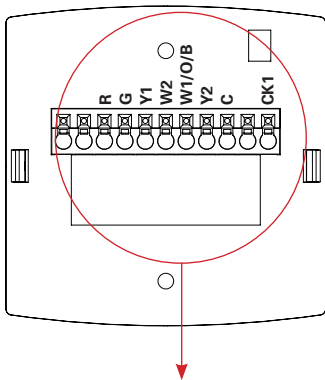

<b>R</b>	24 VAC return
<b>G</b>	Fan relay
<b>W1/O/B</b>	1st stage heat circuit
<b>W2</b>	2nd stage heat circuit
<b>Y1</b>	1st stage compressor relay

<b>Y2</b>	2nd stage compressor relay
<b>C</b>	24 VAC common
<b>CK1</b>	Dry Contact

**IMPORTANT: This thermostat requires both R (24 VAC Return) and C (24 VAC Common) wires be connected to the backplate terminals to operate properly.**



# Installation Instructions

## Check Dip Switch

Ensure which switch is correct for your system. Dip switches are located on the back of the thermostat.

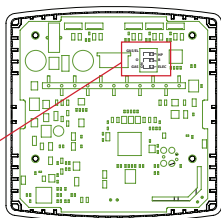
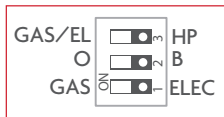

This switch (GAS or ELEC) controls how the thermostat will control the Fan (G) terminal in heating mode. When **GAS** is chosen, the thermostat will not energize the Fan (G) terminal in heating. When **ELEC** is chosen the thermostat will energize the fan in heating.

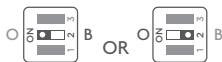

### For Heat Pump Only

When the **GAS/EL** or **HP** dip switch is configured for **HP**, this dip switch (O or B) must be set to control the appropriate reversing valve. If **O** is chosen, the **W1/O/B** terminal will energize in cooling. If **B** is chosen, the **W1/O/B** terminal will energize in heating.



This dip switch configures the thermostat to control a conventional gas/electric system or a heat pump. If your system is anything other than a heat pump, leave this switch set for **GAS/EL**.

# Installation Instructions

## 1 Stage Heat, 1 stage Cool

### Dip Switch Settings

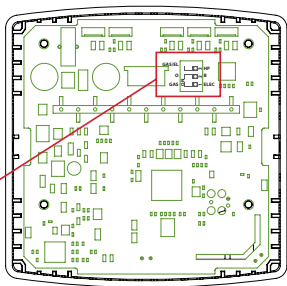
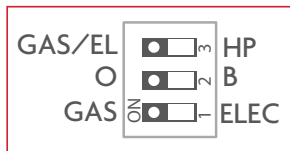

### Thermostat

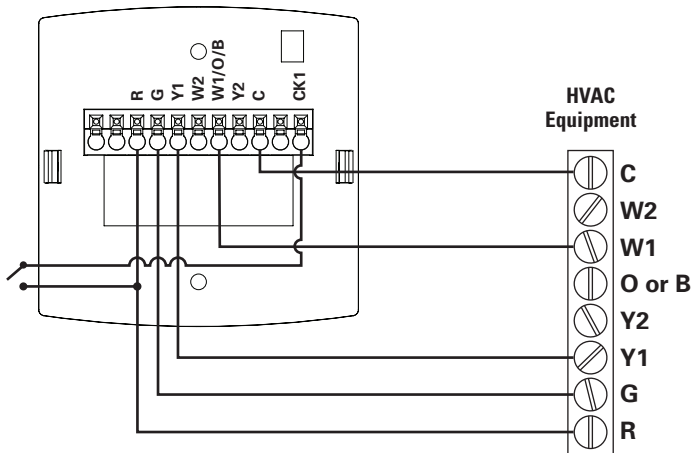

# Installation Instructions

## 2 Stage Heat, 2 Stage Cool

### Dip Switch Settings

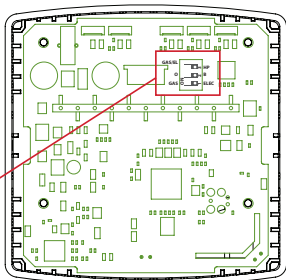
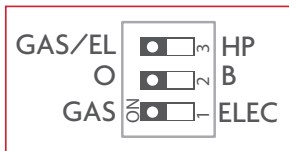

### Thermostat

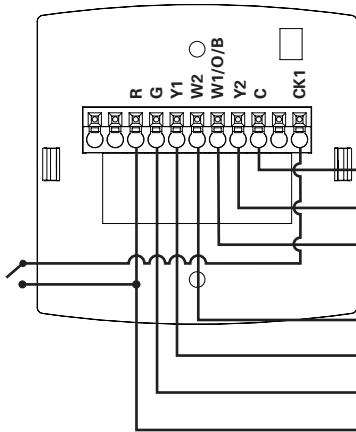

### HVAC Equipment

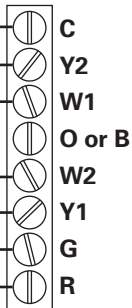

# Installation Instructions

## Single Stage Heat Pump with AUX Heat

### Dip Switch Settings

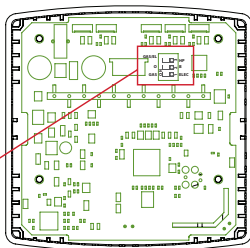
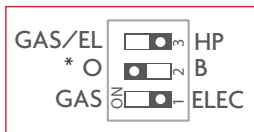

\*Reversing valve choice, O or B, is dependant on the type of valve installed in the heat pump.

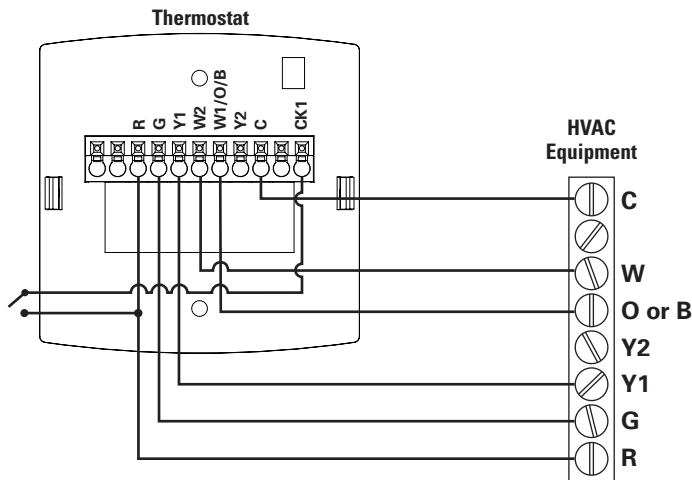

# Installation Instructions

## Dual Stage Heat Pump with AUX Heat

### Dip Switch Settings

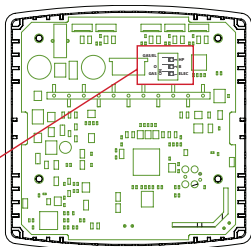
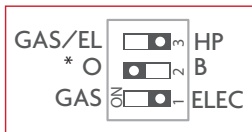

\*Reversing valve choice, O or B, is dependant on the type of valve installed in the heat pump.

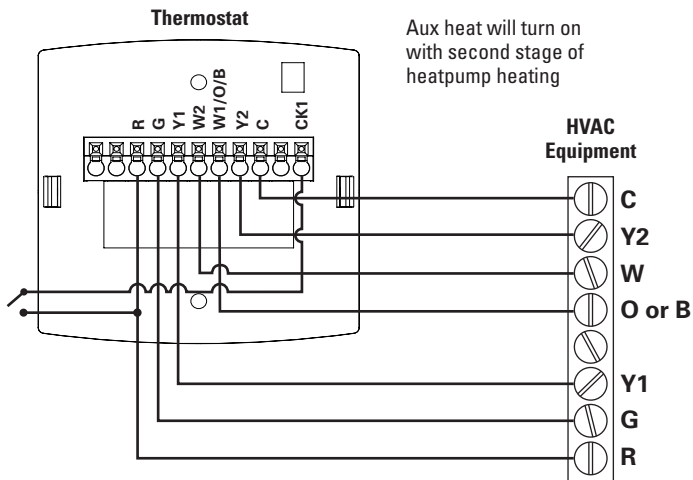

# Installation Instructions

## Heat Only - with Venstar 2-Wire Kit - ACC0436

### Dip Switch Settings

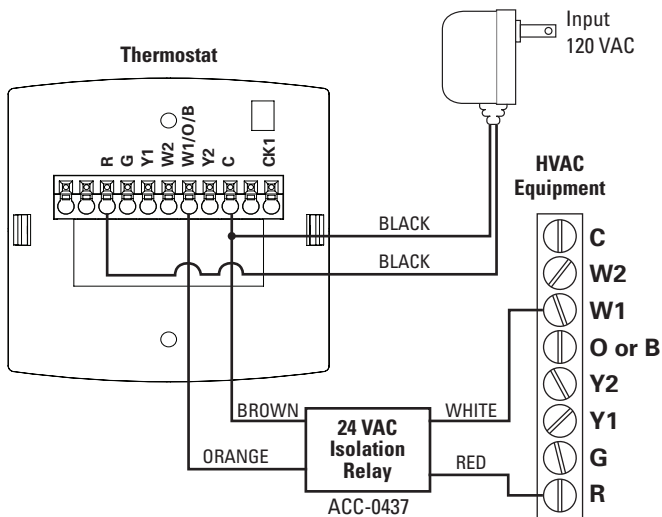
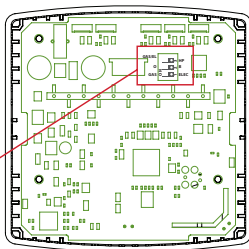
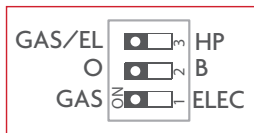

## Connect to Wi-Fi Overview

At minimum the first 3 tasks below must be completed to access your thermostat remotely from a browser. The 4th step is optional (highly recommended) and only is needed to access your thermostat(s) from a mobile device.

### These steps are:

1. Successful connection to a local Wi-Fi Access Point with internet access.
2. Confirm receipt of a Skyport generated verification email (this only occurs once during the Skyport account setup).
3. A 6-digit code obtained from the thermostat is successfully entered into a Skyport account.
4. Successfully download and install the Venstar Skyport app on your mobile device(s).

*Your thermostat operates on the 2.4 Ghz, Wi-Fi b/g/n band.*

### Wi-Fi Symbol Legend



When the only the 'dot' of the Wi-Fi symbol appears = not connected to an access point.



When the full Wi-Fi symbol appears = connected to an access point.



When the full Wi-Fi symbol appears and the 'dot' of the symbol is flashing = connected to Skyport.

## Connect to Wi-Fi Overview

### Wi-Fi Setup

*The Venstar Configurator App is needed to configure the Wi-Fi Settings of this thermostat*

- **Download the Venstar Configurator App** from your mobile device's App Store.



ICON

- **Open the Venstar Configurator App**
  - Choose the Explorer Mini thermostat by sliding the thermostat pictures at the top of the apps' display to the left until you see a picture of the Explorer Mini.
  - Press and hold the OVERRIDE button of the thermostat for approximately 5 seconds to enter Wi-Fi setup screens.
  - Press the cooler button to setup Wi-Fi.
  - Follow the instructions that appear on the Venstar Configurator App.

### Connect to Skyport

Although there is more than one way to create a Skyport account, the steps below illustrate account creation from a browser. To create a Skyport account a thermostat must be joined to the account.

If the thermostat is connected to the local Wi-Fi Access Point, but you do not have a Skyport account, you may create an account and join the thermostat to the account by doing the following:

1. Open your browser to: <http://Venstar.skyportcloud.com>
2. Select "Create account now"

 Create Account Now

3. Follow on screen instructions to create an account and add a thermostat to the Skyport account.



## Connect to Wi-Fi Overview

### Join a Thermostat to Skyport

If the thermostat is connected to the local Wi-Fi access point but not yet joined to an existing Skyport account, you may join the thermostat to the account by doing the following:

1. Log in to your Skyport account.
2. Select the "Location" you want to add a thermostat into.
3. Select the "Thermostat tab".
4. Select "+ Add thermostat". A screen will 'pop-up' asking for a six digit code.
5. Press the OVERRIDE button on the thermostat for 5 seconds.
6. Press the Warmer button on the thermostat.
7. A six digit code will appear on the thermostat's display.
8. Enter the six digit code into your Skyport account.

### Wi-Fi Status Screens

Press and hold the OVERRIDE button on the thermostat for 5 seconds. When "Wi-Fi Setup" appears on the display, press the MODE button. Pressing the up or down button will sequence through the following information:

- AP Name
- AP Signal Strength
- IP Address
- Skyport Status
- API Status

## Front Panel

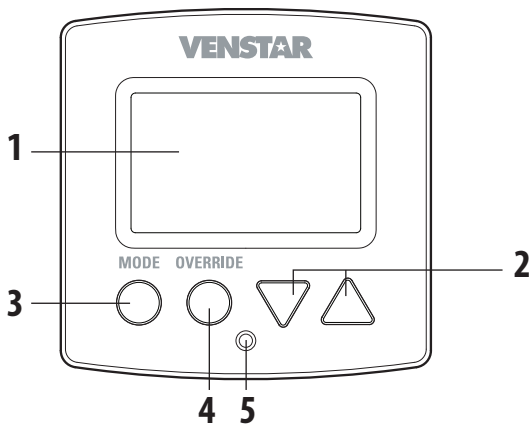

- 1 Backlit Display
- 2 Up/Warmer, Down/Cooler Buttons
- 3 Mode Button
- 4 Override Button
- 5 Heat or Cool Indicator  
*Heat = Red, Cool = Green*

## Display

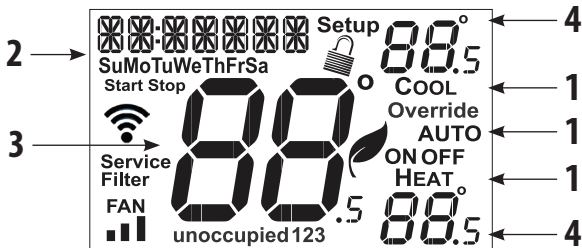

### 1 Mode Indicators

Selects the operational mode of the equipment.

**HEAT** - Indicates the heating mode.

**COOL** - Indicates the cooling mode.

**AUTO** - Indicates the system will automatically changeover between heat and cool modes as the temperature varies.

**OFF** - Indicates heating and cooling are turned off.

### 2 Clock with Day of the Week

Indicates the current time and day. This clock is also used to program the time period schedules.

### 3 Room Temperature Display

Indicates current room temperature.

### 4 Desired Set Temperature

Indicates desired room temperature(s).

## Display

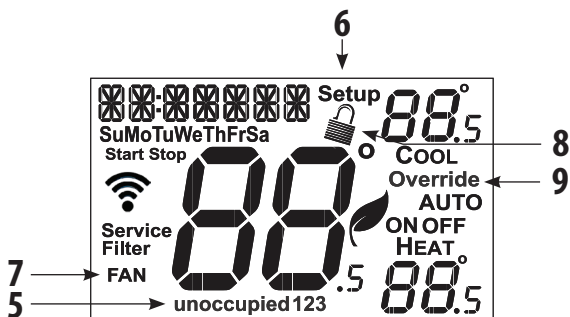

### 5 Occupied and Unoccupied icons

Indicates the part of the time period program.

### 6 Setup icon

Indicates the thermostat is in the setup mode.

### 7 Fan icon

When only the FAN icon is displayed, the fan is always on. If the FAN is not on the display, then the FAN is in Auto mode and will run only when necessary to heat or cool.

### 8 Locked icon

Indicates the thermostat's control buttons have been locked.

### 9 Override icon

Indicates OVERRIDE is enabled.

## Basic Operation

### Selecting Your Desired Temperature (adjusting the setpoints)

#### Auto-Changeover Mode

Pressing the WARMER or COOLER buttons in Auto mode will adjust both the heat and cool setpoints simultaneously. To adjust the heat and cool setpoints individually, choose HEAT mode to adjust the heat setpoint, and COOL mode to adjust the cool setpoint, then return to AUTO mode.



Adjust the desired set temperature with these buttons



#### Heat or Cool Mode

Pressing the UP or DOWN buttons in Heat or Cool mode will adjust only the heat or cool set temperature.

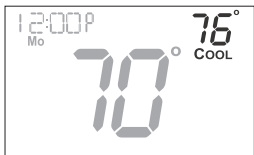

#### Using the Override Button

##### Unoccupied Operation -

During programmed, unoccupied periods, pressing the **OVERRIDE** button will force the thermostat into Occupied 1 settings for 30 minutes. Each press of the **OVERRIDE** button will add another 30 minutes of time up to the amount specified in Setup Step 23. If the maximum time has been set, the next press of the **OVERRIDE** button will reset the timer and return the thermostat to the correct time period program for the day.

**Occupied Operation -** During programmed, occupied periods, pressing the **OVERRIDE** button will force the thermostat into an unoccupied period for the rest of the day. During this forced unoccupied period the **OVERRIDE** button will operate as described above.

##### OVERRIDE



NOTE: OVERRIDE may only be used when the thermostat is set to PROGRAM ON.

# User Setup

Table for button presses that are required for entering various menus

TO ENTER MENU	BUTTON PRESS
Setup Steps	MODE & OVERRIDE for 5 seconds
Time Schedule	MODE & UP for 2 seconds
Emergency Heat	UP & OVERRIDE for 2 seconds
Lockout Buttons	MODE, UP & DOWN for 2 seconds
Calibration	MODE & DOWN for 2 seconds, then MODE
Wireless Setup	OVERRIDE for 5 Seconds

## How to Change Settings in the Setup Screens

To enter the setup screens, press the **MODE** button, and simultaneously press **OVERRIDE** button for 5 seconds. Release the buttons when you see "Setup" on the display. Use the **WARMER** or **COOLER** buttons to adjust the value of your selection. Press **MODE** to advance to the next setup step. Press **MODE** and **OVERRIDE** together again to leave the setup screens.

**MODE** **OVERRIDE**



press together for  
5 seconds

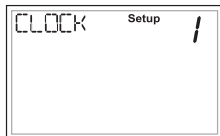

# User Setup

## Setting the Clock and Day

(setup step 1 & 2)

When your thermostat is connected to Skyport Cloud Services, the time and day of the week are controlled by Skyport. There is no local adjustment, Skyport also adjusts the time for Daylight Savings Time as well.

To set the time and day when not connected to Skyport; enter the setup screens by pressing the Mode button and simultaneously pressing the OVERRIDE button for 5 seconds.

**Setup step 1** adjusts the clock. Use the Warmer/Up or Cooler/Down buttons to adjust the time.

Press the Mode button to advance to **step 2**.

Select the day of the week using the Warmer/Up or Cooler/Down buttons.

**Leave the setup screens by again pressing the Mode button and simultaneously pressing the OVERRIDE button for 5 seconds.**

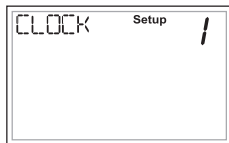

## User Setup: Backlight Operation

### Backlight (Setup Steps 3-6)

#### Backlight (setup step 3)

**OFF** - Backlight turns on only with a button press and turns off after 8 seconds.

**ON** - Backlight is on continuously.

**Night Dimmer** (setup step 4) - Selecting **ON** allows for turning off the backlight of the display during specific times of the day, usually at night.

#### Night Dimmer Start Time

(setup step 5) - 12:00 am to 12:00 am

#### Night Dimmer Stop Time

(setup step 6) - 12:00 am to 12:00 am

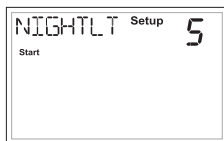
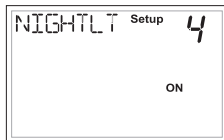
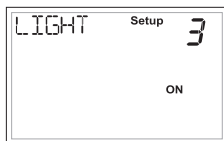

### Fan On or Fan Auto (Setup Step 7)

**FAN ON** - indicates constant fan operation. Fan On is not allowed when the thermostat is in the Off Mode or unoccupied.

If **FAN AUTO** is selected, the fan will only operate during a heat or cool demand.

The Fan is forced into **FAN AUTO** when running a program and the thermostat shows "unoccupied".

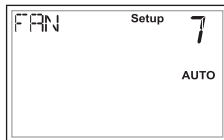



## User Setup: Setpoint Limits

### Setpoint Limits (Setup Steps 8-10)

When this feature is set to ON, the Heat and Cool Setpoints may be restricted to preset levels in Setup Steps 9 and 10.



### Maximum Heat Setpoint (Setup Step 9)

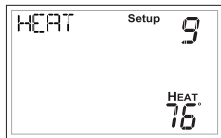

### Minimum Cool Setpoint (Setup Step 10)

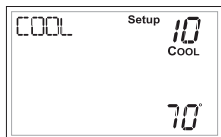

### Lock OVERRIDE and MODE Buttons

This feature is available when the thermostat is connected to Skyport Cloud Services and may only be accessed through Skyport.

This security feature is not accessible locally at the thermostat.

When this setting is enabled; pressing the OVERRIDE or MODE buttons on the thermostat will have no effect.

This feature is often used in conjunction with setpoint limits.

## User Setup: Service Filter

These setup steps allow the user to monitor FAN runtimes and program service alerts. Service alerts appear on the display. If the thermostat is joined to a Skyport account, then the user may be alerted by Skyport Cloud Services when to change the filter.

Runtime hours  
or days appear in  
the clock display.



### OVERRIDE



Press and hold **OVERRIDE**  
to clear reset runtime.

### Service Filter Runtime (Setup Step 11-14)

**Current Service Filter Runtime Hours** (Setup Step 11) - This counter keeps track of the number of hours of fan runtime in the Heating mode, Cooling mode, and in stand alone Fan operation. Press **OVERRIDE** to reset.

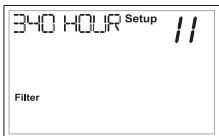

**Current Service Filter Calendar Days** (Setup Step 12) - This counter displays the total number of calendar days that have elapsed since the counter was reset to help the user track Fan runtime. Press **OVERRIDE** to reset.



**Set Service Filter Runtime Hours** (Setup Step 13) - This timer allows the user to specify the number of hours the fan will run before the "Replace Filter" alert will be displayed. Press **COOLER** continuously until **OFF** is displayed to disable this alert.



**Set Service Filter Calendar Days** (Setup Step 14) - This timer allows the user to specify the number of calendar days that will elapse before the "Replace Filter" alert will be displayed. Press **COOLER** continuously until **OFF** is displayed to disable this feature.

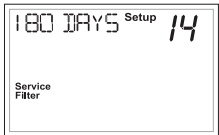

## Installer Setup

### **Cycles Per Hour** (Setup Step 15)

The Cycles Per Hour setting may limit the number of times per hour your HVAC unit may energize. For example, at a setting of 6 cycles per hour the HVAC unit will only be allowed to energize once every 10 minutes. The Cycles Per Hour limit may be overridden and reset by pressing the WARMER or COOLER buttons on the thermostat. Settings are No Limit, 2, 3, 4, 5, or 6 cycles per hour.

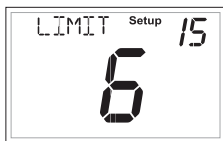

### **Compressor Minimum**

#### **Off Minutes** (Setup Step 16)

This feature allows the user to set a minimum off time for the compressor. Settings are 0 to 5 minutes.



### **Minimum Heat/Cool**

#### **Setpoint Difference** (Setup Step 17)

This feature allows the user to set the minimum gap between Heat and Cool setpoints in AUTO mode. Select from 0 to 6 degrees.

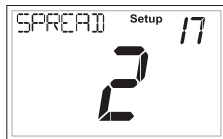

# Installer Setup

## Deadband Settings (Setup Step 18-21)

The Deadband is the number of degrees or minutes that the thermostat waits before it initiates the stages of heating or cooling.

### 1st Stage Deadband (Setup Step 18)

Specifies the temperature difference between the room temperature and the desired setpoint before the first stage of heating or cooling is allowed to turn on. (1 - 6 degrees) For example, if the heat setpoint is 68° and the 1st Stage deadband is set to 2 degrees, the room temperature will need to reach 66° before the heat turns on.

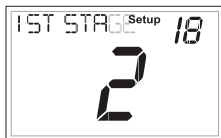

### 2nd Stage Deadband (Setup Step 19)

Specifies the additional temperature difference after the first stage turns on before the second stage is activated. (0° - 10°)



### Minutes Between 1st and 2nd Stage

(Setup Step 20)

Specifies the minimum time (in minutes) after the first stage turns on before the second stage can turn on. (0 - 60)

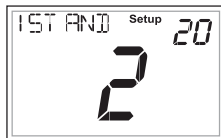

### Second Stage Turnoff Point (Setup Step 21)

Specifies whether second stage will turn off at first stage deadband or remain on until the room temperature demand is satisfied. Choose between Deadband or Setpoint.

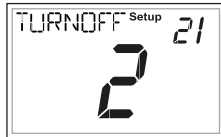

## Installer Setup

### **Fan Off Delay in Seconds** (Setup Step 22)

This feature allows the user to increase the cooling or electric strip heating efficiency of the system. The thermostat may be programmed to continue running the fan after a call for cooling or electric strip heating has been satisfied. This delay can be set for 0, 30, 60, 90, or 120 seconds. If set to 0, the fan will not run after a call for cooling or electric strip heating has been satisfied.

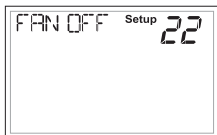

### **Maximum Override Time** (Setup Step 23)

This feature limits the maximum override time when using the OVERRIDE button 1 - 4 hours.



### **Fahrenheit or Celsius** (Setup Step 24)

This feature allows the thermostat to display temperature in Fahrenheit or Celsius.

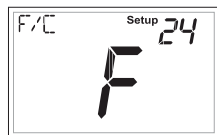

## Installer Setup

### Comfort Recovery (Setup Step 25)

With Comfort Recovery on, the thermostat will attempt to reach the OCCUPIED 1 setpoint temperature at the exact time programmed into the thermostat. Comfort Recovery, only works when the thermostat enters the OCCUPIED 1 from the UNOCCUPIED. For example, if OCCUPIED 1 is set for 6am at 72°F heating and 75°F cooling, the thermostat will turn the system on before 6am in an effort to bring the temperature to its correct setting at exactly 6am. The thermostat learns from experience, how early to turn on, so please allow 4-8 days after a program change or after initial installation to give Comfort Recovery time to adjust. If used with a heat pump, electric strip heat will be disabled while Comfort Recovery is active.



### Pre-Occupancy Fan Purge (Setup Step 26)

When this feature is activated, the fan will turn on during an unoccupied period at a preset amount of time prior to Occupied 1. This pre-occupancy fan purge timer may be set from zero to three hours, in 15 minute increments. Zero (0) means this feature is turned off.

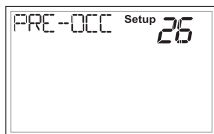

# Installer Setup

## Dry Contact Operation

### Dry Contact Polarity (Setup Step 27)

**Open (Normally Open)** - The dry contact is open until the connected device closes the circuit.



'Idle'



'Active'

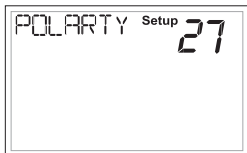

**Closed (Normally Closed)** - The dry contact is closed until the connected device opens the circuit.



'Idle'



'Active'

### Dry Contact Use (Setup Step 28)

**Condensate Pan** - If selected when the Dry Contact is active, the thermostat will lockout compressor terminal(s) and "CONDENSATE PAN" will appear on the display.

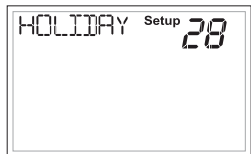

**Holiday** - If Holiday is selected when the dry contact is active, the thermostat will be forced into HOLIDAY/ Unoccupied settings.

**FDD** - If FDD is selected when the dry contact is active, "EQUIP FAULT" will appear on the display.

**Occupied** - If Occupied is selected when the dry contact is active, the thermostat will be forced into occupied settings.

# Installer Setup

## Skyport Cloud Services

(Setup Step 29)

If set to ON, the thermostat may communicate and receive data from the Skyport Cloud Services.



## Local API (Setup Step 30)

Turning on the local API allows 3rd party software to interface with the thermostat such as a home automation system.

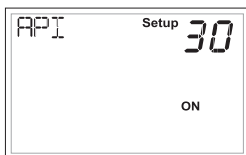

**NOTE:** It is permissible to enable both Skyport and the local API at the same time.

## Available Modes (Setup Step 31)

This setup step may restrict the use of this thermostat to: Heat only or, Cool only, or Heat and Cool, or Auto changeover operation.



## Show Clock (Setup Step 32)

This setup step will allow for removal of the clock and day of the week from the display. OFF removes the time and day from the display.

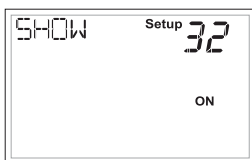



## Installer Setup

### Locking/Unlocking the Keypad

To prevent unauthorized use of the thermostat, the front panel buttons may be disabled. To disable, or 'lock' the keypad, press and hold the MODE button. While holding the MODE button, press the WARMER and COOLER buttons together, for two seconds.

The  icon will appear on the display, then release the buttons.

Press all three buttons in the order outlined for keypad lockout

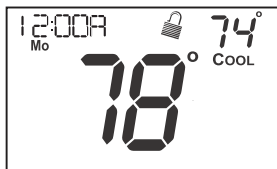

MODE



To **unlock** the keypad, press and hold the MODE button. While holding the MODE button, press the WARMER and COOLER buttons together, for two seconds.

The  icon will disappear from the display, then release the buttons.

## Programming a Daily Schedule

### Programming a Daily Schedule

To enter Time Period Programming screens, Press and hold MODE and UP until the scrolling prompt appears.

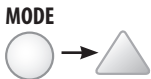

**Select the number of Occupied time periods** – Press the Warmer or Cooler buttons to choose the maximum number (up to 3 maximum) of Occupied time periods in a day.

**Select the Mode for the Occupied period** – Press the Warmer or Cooler buttons to choose the mode for the occupied period. The choices are: Off, Heat only, Cool only and AUTO changeover.

**Adjust the Occupied Cool Setpoint** – Press the Warmer or Cooler buttons to adjust the Cooling setpoint for comfort.

**Adjust the Occupied Heat Setpoint** – Press the Warmer or Cooler buttons to adjust the Heating setpoint for comfort.

**Set the Unoccupied Mode** – Press the Warmer or Cooler buttons to choose the mode for the Unoccupied period. The thermostat is in Unoccupied when the Time Period Schedule is running and there is not an active Occupied period. The choices are: Off, Heat only, Cool only and AUTO changeover.

**Adjust the Unoccupied Cool Setpoint** – Press the Warmer or Cooler buttons to adjust the Cooling setpoint for times when the thermostat is in Unoccupied.

*Continued*

## Programming a Daily Schedule

*Continued*

**Adjust the Unoccupied Heat Setpoint** – Press the Warmer or Cooler button to adjust the Heating setpoint for times when the thermostat is in Unoccupied.

***The following steps determine when the Occupied period(s) will be active.***

**Enable Occupied 1** – Press the Warmer or Cooler button to enable (On) or to disable (Off) Occupied 1 on Monday.

**Adjust the Start Time for Occupied 1** – Press the Warmer or Cooler button to adjust the start time for Occupied 1 on Monday.

**Adjust the Stop Time for Occupied 1** – Press the Warmer or Cooler button to adjust the stop time for Occupied 1 on Monday.

Upon pressing MODE after the above step; you will be prompted to Save and Exit or Copy this Occupied schedule to another day.

**To save and exit** – Press the MODE and WARMER button.

**To Copy Monday's settings/schedule to Tuesday** – Press Up and then MODE. Press MODE again to copy the Monday Settings/schedule to subsequent days.

**To Program Another Day** – Press MODE and then press the WARMER/COOLER button to select the day to program. Repeat the above steps for each day you would like to program.

***Press and hold the MODE/WARMER Buttons to exit Time Period Programming at any time.***

## About Advanced Features & Operation

### Deadband Operation

Controls up to two Heat and two Cool stages.

The **1st Stage** of heat or cool is turned on when:

**(A)** The temperature spread from the setpoint is equal to or greater than: *the setpoint plus the 1st stage deadband*. This 1st stage deadband is adjustable from 1-6 degrees and the default is two degrees.

The **2nd Stage** of heat or cool is turned on when:

**(A)** The 1st Stage has been on for a minimum of two minutes (default setting).

#### **AND**

**(B)** The temperature spread from the setpoint is equal to or greater than: *the setpoint plus the 1st stage deadband, plus the 2nd stage deadband*. This 2nd stage deadband is adjustable from 0 - 10 degrees.

### Turning on the Time Period Program

Pressing the **MODE** button should cycle through **OFF**, then the available modes (setup step #31) then Program **ON**. Note that this sequence may be restricted due to settings on the Skyport website. The thermostat can be configured to be non-programmable which will keep Program **ON** from appearing in the **MODE** sequence. The thermostat can also be configured to force the program to always be running so the **MODE** button will have no effect. This last setting is desirable in many commercial installations to keep users from changing to manual control and negating the energy savings possible when running the program.

## About Advanced Features & Operation

### Emergency Heat

Only available if you have a Heat Pump installed. To initiate the **Emergency Heat** feature, press the **OVERRIDE** button. While holding the **OVERRIDE** button press the **UP** button, for two seconds. The display will read 'EM HEAT'  
(Emergency Heat).

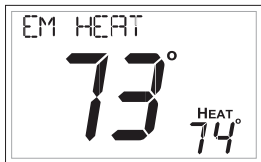

During Emergency Heat operation the thermostat will turn on the fan and the Aux strip heat when there is a demand for heat. Also during Emergency Heat, heatpump operation will be unavailable.

### Exit Emergency Heat

Follow the same steps as entering **Emergency Heat** by pressing the **OVERRIDE** and **UP** buttons, for two seconds. During Emergency Heat, only OFF and HEAT modes are available by pressing the **MODE** button.

# About Advanced Features & Operation

## Calibration

Under normal circumstances it will not be necessary to adjust the calibration of the temperature sensor. If calibration is required, please contact a trained HVAC technician to correctly perform the following procedure.

- 1 **MODE** Place the thermostat in the OFF mode.

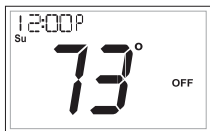

- 2 **MODE** Press and hold the MODE button. While holding the **MODE** button, press and hold the **DOWN** button for 5 seconds.



All icons will appear on the display.

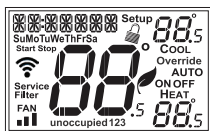

- 3 **MODE** Press the **MODE** button once. The thermostat temperature will be displayed and may be calibrated using the **UP** or **DOWN** buttons. The calibrated offset from the "raw" temperature reading is displayed in the lower right corner.

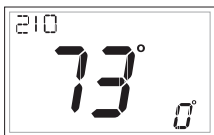

Additionally, on this screen you may view the Software Version in the upper left corner.

- 4 **MODE** After calibration is complete, press the **MODE** button **once** to save your changes and return to normal operation.

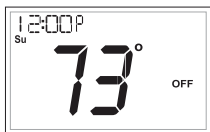

# About Advanced Features & Operation



## Factory Defaults

If, for any reason, you desire to return all the stored settings back to the factory default settings, follow the instructions below.

**WARNING: This will reset all Time Period and Advanced Programming to the default settings. Any information entered prior to this reset will be permanently lost.**

- MODE**  
 Place the thermostat in the OFF mode.

---

- MODE**  
  
 Press and hold the MODE button. While holding the MODE button, press and hold the DOWN button for 5 seconds. All icons will appear on the display.

---

- 3**  
**OVERRIDE**  

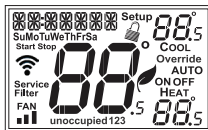
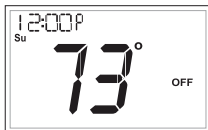
  - After all of the icons appear, release the MODE and DOWN buttons.
  - Press and hold the OVERRIDE button for 2 seconds. Fd (Factory default settings) and ALL will appear on the display.



(Continued)

## About Advanced Features & Operation

(Continued)

You now have the option of restoring the factory settings to just Wi-Fi (**Wi-Fi**), or just the thermostat (**STAT**), or both the thermostat and Wi-Fi (**ALL**).

**C.** Select one of the above options using the Up or Down buttons.

**D.** Press **OVERRIDE** for 2 seconds to restore the factory settings.



**OVERRIDE**



After factory settings are restored, the thermostat display will return to the "all icon" screen.

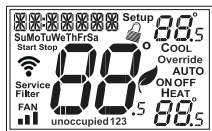

4

**MODE**



To return to normal operation;  
Press the **MODE** button twice.



# Advanced Setup Table

FD = Factory Default Setting

Step#	Description	Pg#	Range	FD
1	Set Clock	18	12A - 12A	
2	Set Day of the Week	18	Monday - Sunday	
3	Backlight	19	On, Off, 6pm-6am	Off
4	Night Dimmer	19	On/Off	Off
5	Night Dimmer Start Time	19	12A - 12A	8:00PM
6	Night Dimmer Stop Time	19	12A - 12A	6:00AM
7	Fan On or Fan Auto	19	Fan, Fan Auto	Fan Auto
8	Setpoint Limits	20	On, Off	Off
9	Maximum Heat Setpoint Limit	20	35 - 99 Degrees	74
10	Minimum Cool Setpoint Limit	20	35 - 99 Degrees	70
11	Current Service Filter Runtime Hours	21	0 - 1999 Hours	0
12	Current Service Filter Calendar Days	21	0 - 720 Days	0
13	Set Service Filter Runtime Hours	21	0-1999 Hours	0
14	Set Service Filter Calendar Days	21	0 - 720 Days	0
15	Cycles Per Hour	22	No Limit, 2, 3, 4, 5, 6	6
16	Compressor Minimum Off Minutes	22	0, 3, 5 Minutes	5
17	Min. Heat/Cool Setpoint Difference	22	0 - 6	2
18	1st Stage Deadband	23	1 - 6 Degrees	2
19	Second Stage Deadband	23	0 - 10 Degrees	2
20	Minutes Between 1st and 2nd Stage	23	0 - 60 Minutes	2
21	2nd Stage Turnoff Point	23	Deadband, Setpoint	Deadband
22	Fan Off Delay	24	0, 120 Seconds	0
23	Maximum Override Time	24	1, 2, 3 or 4 hours	4
24	F / C	24	Fahrenheit (F), or Celsius C	F
25	Comfort Recovery	25	On, Off	Off
26	Pre-Occupancy Fan Purge	25	0 - 3 Hours in 15 minute increments, 0 + Off	0
27	Dry Contact Polarity	26	Open, Closed	Open
28	Dry Contact Use	26	Condensate Pan, Holiday, FDD, Occupied	Holiday
29	Skyport	27	On, Off	On
30	Local API	27	On, Off	Off
31	Available Modes	27	Heat, Cool, Heat or Cool, Auto	Auto
32	Show Clock	27	On, Off	On

## TO ENTER MENUS ..... BUTTON PRESS

Setup Steps ..... MODE & OVERRIDE for 5 sec.

Time Schedule ..... MODE & UP for 2 seconds

Emergency Heat ..... UP & OVERRIDE for 2 seconds

## TO ENTER MENUS ..... BUTTON PRESS

Lockout Buttons ..... MODE, UP & DOWN for 2 sec.

Calibration ..... MODE & DOWN for 2 sec., then MODE

Wireless Setup ..... OVERRIDE for 5 Seconds

# Warranty

One-Year Warranty - This Product is warranted to be free from defects in material and workmanship. If it appears within one year from the date of original installation, whether or not actual use begins on that date, that the product does not meet this warranty, a new or remanufactured part, at the manufacturer's sole option to replace any defective part, will be provided without charge for the part itself provided the defective part is returned to the distributor through a qualified servicing dealer.

THIS WARRANTY DOES NOT INCLUDE LABOR OR OTHER COSTS incurred for diagnosing, repairing, removing, installing, shipping, servicing or handling of either defective parts or replacement parts. Such costs may be covered by a separate warranty provided by the installer.

THIS WARRANTY APPLIES ONLY TO PRODUCTS IN THEIR ORIGINAL INSTALLATION LOCATION AND BECOMES VOID UPON REINSTALLATION.

LIMITATIONS OF WARRANTIES – ALL IMPLIED WARRANTIES (INCLUDING IMPLIED WARRANTIES OF FITNESS FOR A PARTICULAR PURPOSE AND MERCHANTABILITY) ARE HEREBY LIMITED IN DURATION TO THE PERIOD FOR WHICH THE LIMITED WARRANTY IS GIVEN. SOME STATES DO NOT ALLOW LIMITATIONS ON HOW LONG AN IMPLIED WARRANTY LASTS, SO THE ABOVE MAY NOT APPLY TO YOU. THE EXPRESSED WARRANTIES MADE IN THIS WARRANTY ARE EXCLUSIVE AND MAY NOT BE ALTERED, ENLARGED, OR CHANGED BY ANY DISTRIBUTOR, DEALER, OR OTHER PERSON WHATSOEVER.

ALL WORK UNDER THE TERMS OF THIS WARRANTY SHALL BE PERFORMED DURING NORMAL WORKING HOURS. ALL REPLACEMENT PARTS, WHETHER NEW OR REMANUFACTURED, ASSUME AS THEIR WARRANTY PERIOD ONLY THE REMAINING TIME PERIOD OF THIS WARRANTY. THE

MANUFACTURER WILL NOT BE RESPONSIBLE FOR:

1. Normal maintenance as outlined in the installation and servicing instructions or owner's manual, including filter cleaning and/or replacement and lubrication.
2. Damage or repairs required as a consequence of faulty installation, misapplication, abuse, improper servicing, unauthorized alteration or improper operation.
3. Failure to start due to voltage conditions, blown fuses, open circuit breakers or other damages due to the inadequacy or interruption of electrical service.
4. Damage as a result of floods, winds, fires, lightning, accidents, corrosive environments or other conditions beyond the control of the Manufacturer.
5. Parts not supplied or designated by the Manufacturer, or damages resulting from their use.
6. Manufacturer products installed outside the continental U.S.A., Alaska, Hawaii, and Canada.
7. Electricity or fuel costs or increases in electricity or fuel costs for any reason whatsoever including additional or unusual use of supplemental electric heat.
8. ANY SPECIAL INDIRECT OR CONSEQUENTIAL PROPERTY OR COMMERCIAL DAMAGE OF ANY NATURE WHATSOEVER. Some states do not allow the exclusion of incidental or consequential damages, so the above may not apply to you.

This warranty gives you specific legal rights and you may also have other rights which may vary from state to state.



Printed on recycled paper.

P/N 88-1195 rev.2 02/19

**VENSTAR<sup>®</sup>**