



National Aeronautics and
Space Administration

Educational Product

Educators

Grades K-12

EG-2003-01-108-HQ

ROCKETS

**An Educator's Guide with Activities in Science,
Mathematics, and Technology**

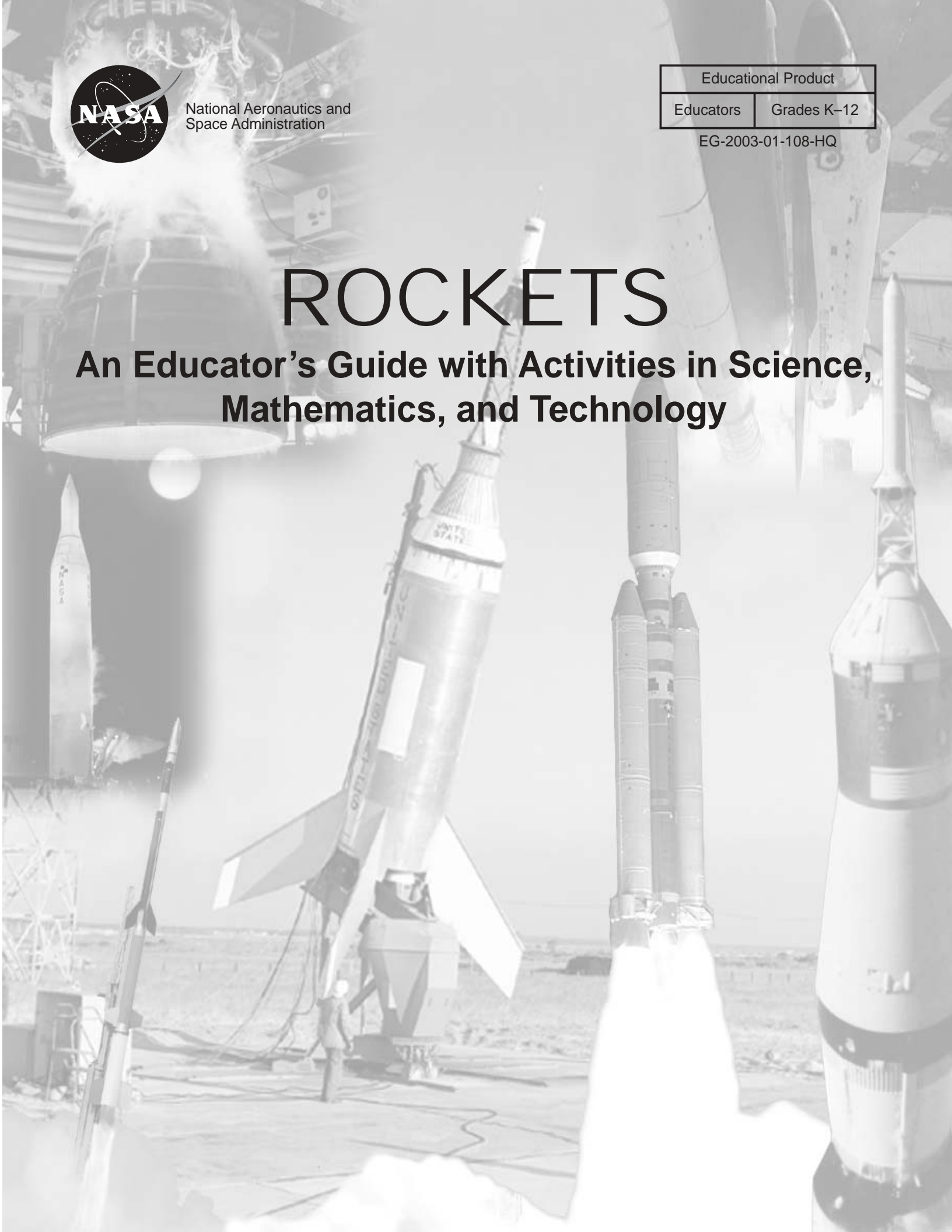

ROCKETS

**An Educator's Guide with Activities In Science,
Mathematics, and Technology**

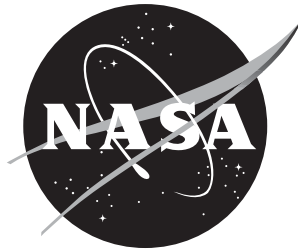

National Aeronautics and Space Administration

**Office of Human Resources and Education
Office of Education
Washington, DC**

**Teaching From Space Program
NASA Johnson Space Center
Houston, TX**

This publication is in the Public Domain and is not protected by copyright.
Permission is not required for duplication.

EG-2003-01-108-HQ

Acknowledgments

This publication was developed for the National Aeronautics and Space Administration with the assistance of hundreds of teachers in the Texas Region IV area and educators of the Aerospace Education Services Program, Oklahoma State University.

Writers:

Deborah A. Shearer
Gregory L. Vogt, Ed.D.
Teaching From Space Program
NASA Johnson Space Center
Houston, TX

Editor:

Carla B. Rosenberg
Teaching From Space Program
NASA Headquarters
Washington, DC

Special Thanks to:

Timothy J. Wickenheiser
Chief, Advanced Mission Analysis Branch
NASA Lewis Research Center

Gordon W. Eskridge
Aerospace Education Specialist
Oklahoma State University

Dale M. Olive
Teacher, Hawaii



Table of Contents

How To Use This Guide	1
Activity Format	3
Brief History of Rockets	5
Rocket Principles	13
Practical Rocketry	18
Launch Vehicle Family Album	25
Activities	35
Activity Matrix	36
Pop Can Hero Engine	39
Rocket Racer	45
3-2-1 Pop!	53
Antacid Tablet Race	57
Paper Rockets	61
Newton Car	67
Balloon Staging	73
Rocket Transportation	76
Altitude Tracking	79
Bottle Rocket Launcher	87
Bottle Rocket	91
Project X-35	95
Additional Extensions	114
Glossary	115
NASA Educational Materials	116
Suggested Reading	116
Electronic Resources	117
NASA Resources for Educators	118
NASA Educator Resource Center Network	118
Evaluation Reply Card	Insert

How To Use This Guide

Rockets are the oldest form of self-contained vehicles in existence. Early rockets were in use more than two thousand years ago. Over a long and exciting history, rockets have evolved from simple tubes filled with black powder into mighty vehicles capable of launching a spacecraft out into the galaxy. Few experiences can compare with the excitement and thrill of watching a rocket-powered vehicle, such as the Space Shuttle, thunder into space. Dreams of rocket flight to distant worlds fire the imagination of both children and adults.

With some simple and inexpensive materials, you can mount an exciting and productive unit about rockets for children that incorporates science, mathematics, and technology education. The many activities contained in this teaching guide emphasize hands-on involvement, prediction, data collection and interpretation, teamwork, and problem solving. Furthermore, the guide contains background information about the history of rockets and basic rocket science to make you and your students “rocket scientists.”

The guide begins with background information on the history of rocketry, scientific principles, and practical rocketry. The sections on scientific principles and practical rocketry focus on Sir Isaac Newton’s Three Laws of Motion. These laws explain why rockets work and how to make them more efficient.

Following the background sections are a series of activities that demonstrate the basic science of rocketry while offering challenging tasks in design. Each activity employs basic and inexpensive materials. In each activity you will find construction diagrams, material and tools lists, and instructions. A brief background section within the activities elaborates on the concepts covered in the activities and points back to the introductory material in the guide. Also included is information about where the activity applies to science and mathematics standards, assessment ideas, and extensions. Look on page 3 for more details on how the activity pages are constructed.

Because many of the activities and demonstrations apply to more than one subject area, a matrix chart identifies opportunities for extended learning experiences. The chart indicates these subject areas by activity title. In addition, many of the student activities encourage



student problem-solving and cooperative learning. For example, students can use problem-solving to come up with ways to improve the performance of rocket cars. Cooperative learning is a necessity in the *Altitude Tracking* and *Balloon Staging* activities.

The length of time involved for each activity varies according to its degree of difficulty and the development level of the students. With the exception of the *Project X-35* activity at the guide's end, students can complete most activities in one or two class periods.

Finally, the guide concludes with a glossary of terms, suggested reading list, NASA educational resources including electronic resources, and an evaluation questionnaire. We would appreciate

your assistance in improving this guide in future editions by completing the questionnaire and making suggestions for changes and additions.

A Note on Measurement

In developing this guide, metric units of measurement were employed. In a few exceptions, notably within the "Materials and Tools" lists, English units have been listed. In the United States, metric-sized parts such as screws and wood stock are not as accessible as their English equivalents. Therefore, English units have been used to facilitate obtaining required materials.



Activity Format

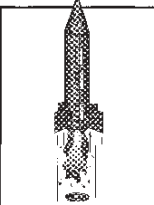

Teacher Information
3-2-1 POP!

Objective:
To demonstrate how rocket liftoff is an application of Newton's Laws of Motion.

Description:
Students construct a rocket powered by the pressure generated from an effervescent antacid tablet reacting with water.

Objectives of the Activity

Description of What the Activity Does

Assessment Ideas

Standards

Science Standards:
Physical Science - Position and motion of objects
Science and Technology - Abilities of technological design - Understanding about science and technology

Process Skills:
Observing
Communicating
Making Models
Inferring

Management:
For best results, students should work in pairs. It will take approximately 40 to 45 minutes to complete the activity. Make samples of rockets in various stages of completion available for students to study. This will help some students visualize the construction steps.

A single sheet of paper is sufficient to make a rocket. Be sure to tell the students to plan how they are going to use the paper. Let the students decide whether to cut the paper the short or long direction to make the body tube of the rocket. This will lead to rockets of different lengths for flight comparison.

Background Information

Background Information:
This activity is a simple but exciting demonstration of Newton's Laws of Motion. The rocket lifts off because it is acted upon by an unbalanced force (First Law). This is the force produced when the lid blows off by the gas formed in the canister. The rocket travels upward with a force that is equal and opposite to the downward force propelling the water, gas, and lid (Third Law). The amount of force is directly proportional to the mass of water and gas expelled from the canister and how fast it accelerates (Second Law). For a more complete discussion of Newton's Laws of Motion, see pages 13-17 in this guide.

Procedure:
Refer to the Student Sheet.

Discussion:

- How does the amount of water placed in the cylinder affect how high the rocket will fly?
- How does the temperature of the water affect how high the rocket will fly?
- How does the amount of the tablet used affect how high the rocket will fly?
- How does the length or empty weight of the rocket affect how high the rocket will fly?
- How would it be possible to create a two-stage rocket?

Materials and Tools

- Heavy paper (90-110 index stock or construction paper)
- Plastic 35 mm film canister*
- Student sheets
- Colophane tape
- Scissors
- Effervescent antacid tablet
- Paper towels
- Water
- Eye protection
- *The film canister must have an internal-sealing lid. See management section for more details.

Extensions

Assessment:
Ask students to explain how Newton's Laws of Motion apply to this rocket. Compare the rockets for skill in construction. Rockets that use excessive paper and tape are likely to be less efficient fliers because they carry additional weight.

Extensions:

- Hold an altitude contest to see which rockets fly the highest. Launch the rockets near a wall in a room with a high ceiling. Tape a tape measure to the wall. Stand back and observe how high the rockets travel upward along the wall. Let all students take turns measuring rocket altitudes.
- What geometric shapes are present in a rocket?
- Use the discussion questions to design experiments with the rockets. Graph your results.

Management Tips

Start quite with Activities in Science, Mathematics, and Technology EG-108 June 1999

What You Need

Student Instruction Pages

3-2-1 POP!

1



Wrap and tape a tube of paper around the film canister. The lid end of the canister goes down!

2



Lid

3



Tape fins to your rocket.

4





Roll a cone of paper and tape it to the rocket's upper end.

5

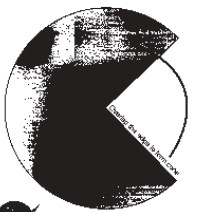

Ready for flight

NASA
Activities: A Teacher's Guide with Activities in Science, Mathematics, and Technology EG-108 June 1999

Student Data Pages

ROCKETEER NAMES

COUNTDOWN:

- Put on your eye protection.
- Turn the rocket upside down and fill the canister one-third full of water.

Work quickly on the next steps!

- Drop in 1/2 tablet.
- Snap lid on tight.
- Stand rocket on launch platform.
- Stand back.

LIFTOFF!

What three ways can you improve your rocket?

- _____
- _____
- _____

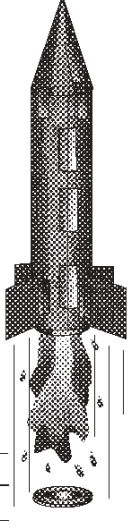

NASA
Activities: A Teacher's Guide with Activities in Science, Mathematics, and Technology EG-108 June 1999





Brief History of Rockets

Today's rockets are remarkable collections of human ingenuity that have their roots in the science and technology of the past. They are natural outgrowths of literally thousands of years of experimentation and research on rockets and rocket propulsion.

One of the first devices to successfully employ the principles essential to rocket flight was a wooden bird. The writings of Aulus Gellius, a Roman, tell a story of a Greek named Archytas who lived in the city of Tarentum, now a part of southern Italy. Somewhere around the year 400 B.C., Archytas mystified and amused the citizens of Tarentum by flying a pigeon made of wood. Escaping steam propelled the bird suspended on wires. The pigeon used the action-reaction principle, which was not to be stated as a scientific law until the 17th century.

About three hundred years after the pigeon, another Greek, Hero of Alexandria, invented a similar rocket-like device called an *aeolipile*. It, too, used steam as a propulsive gas. Hero mounted a sphere on top of a water kettle. A fire below the kettle turned the water into steam, and the gas traveled through pipes to the sphere. Two L-shaped tubes on opposite sides of the sphere allowed the gas to escape, and in doing so gave a thrust to the sphere that caused it to rotate.

Just when the first true rockets appeared is unclear. Stories of early rocket-like devices appear sporadically through the historical records of various cultures. Perhaps the first true rockets were accidents. In the first century A.D., the Chinese reportedly had a simple form of gunpowder made from saltpeter, sulfur, and charcoal dust. They used the gunpowder mostly for fireworks in religious and other festive celebrations. To create explosions during religious festivals, they filled bamboo tubes with the mixture and tossed them into fires. Perhaps some of those tubes failed to explode and instead skittered out of the fires, propelled by the gases and sparks produced from the burning gunpowder.

The Chinese began experimenting with the gunpowder-filled tubes. At some point, they attached bamboo tubes to arrows and launched them with bows. Soon they discovered that these gunpowder tubes could launch themselves just by the power produced from the escaping gas. The true rocket was

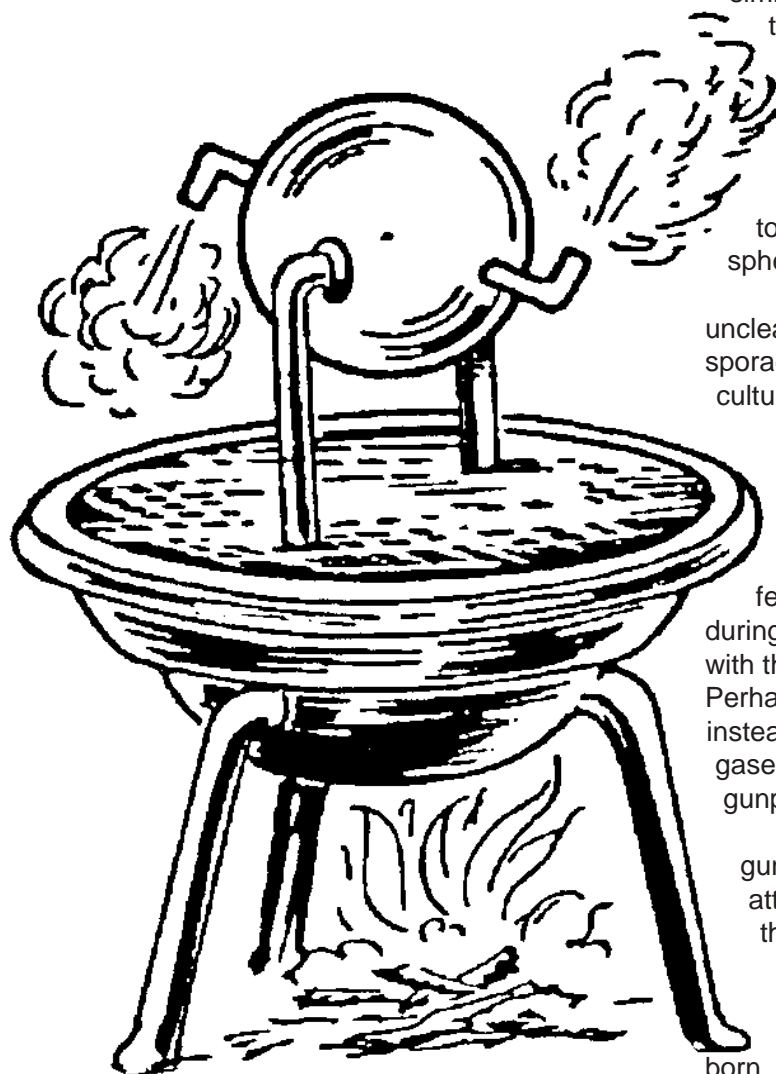

Hero Engine

born.



The date reporting the first use of true rockets was in 1232. At this time, the Chinese and the Mongols were at war with each other. During the battle of Kai-Keng, the Chinese repelled the Mongol invaders by a barrage of “arrows of flying fire.” These fire-arrows were a simple form of a solid-propellant rocket. A tube, capped at one end, contained gunpowder. The other end was left open and the tube was attached to a long stick. When the powder ignited, the rapid burning of the powder produced fire, smoke, and gas that escaped out the open end and produced a thrust. The stick acted as

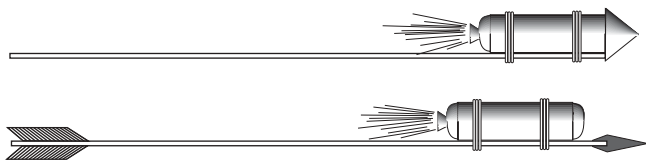

Chinese Fire-Arrows

a simple guidance system that kept the rocket headed in one general direction as it flew through the air. How effective these arrows of flying fire were as weapons of destruction is not clear, but their psychological effects on the Mongols must have been formidable.

Following the battle of Kai-Keng, the Mongols produced rockets of their own and may have been responsible for the spread of rockets to Europe. Many records describe rocket experiments through out the 13th to the 15th centuries. In England, a monk named Roger Bacon worked on improved forms of gunpowder that greatly increased the range of rockets. In France, Jean Froissart achieved more accurate flights by launching rockets through tubes. Froissart’s idea was the forerunner of the modern bazooka. Joanes de Fontana of Italy designed a surface-running rocket-powered torpedo for setting enemy ships on fire.



Chinese soldier launches a fire-arrow.

By the 16th century rockets fell into a time of disuse as weapons of war, though they were still used for fireworks displays, and a German fireworks maker, Johann Schmidlap, invented the “step rocket,” a multi-staged vehicle for lifting fireworks to higher altitudes. A large sky rocket (first stage) carried a smaller sky rocket (second stage). When the large rocket burned out, the smaller one continued to a higher altitude before showering the sky with glowing cinders. Schmidlap’s idea is basic to all rockets today that go into outer space.

Nearly all uses of rockets up to this time were for warfare or fireworks, but an interesting old Chinese legend reports the use of rockets as a means of transportation. With the help of many

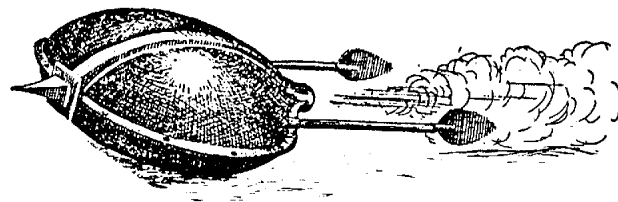

Surface-Running Torpedo

assistants, a lesser-known Chinese official named Wan-Hu assembled a rocket-powered flying chair. He had two large kites attached to the chair, and fixed to the kites were forty-seven fire-arrow rockets.

On the day of the flight, Wan-Hu sat himself on the chair and gave the command to light the rockets. Forty-seven rocket assistants, each armed with torches, rushed forward to light the fuses. A tremendous roar filled the air, accompanied by billowing clouds of smoke. When the smoke cleared, Wan-Hu and his flying chair were gone. No one knows for sure what happened to Wan-Hu, but if the event really did take place, Wan-Hu and his chair probably did not survive the explosion. Fire-arrows were as apt to explode as to fly.

Rocketry Becomes a Science

During the latter part of the 17th century, the great English scientist Sir Isaac Newton (1642-1727) laid the scientific foundations for modern rocketry. Newton organized his understanding of physical motion into three scientific laws. The laws explain how rockets work and why they are able to work in the vacuum of outer space. (See *Rocket Principles* for more information on Newton’s Three Laws of Motion beginning on page 13.)



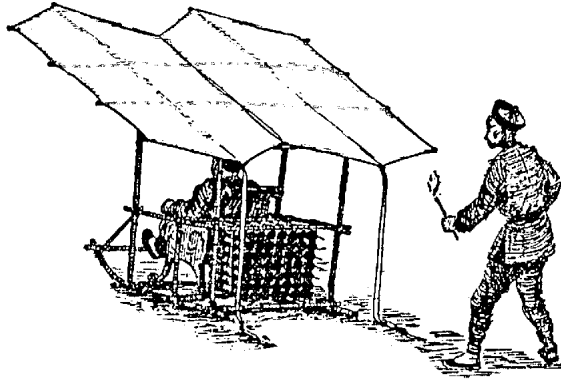

Legendary Chinese official Wan Hu braces himself for "liftoff."

Newton's laws soon began to have a practical impact on the design of rockets. About 1720, a Dutch professor, Willem Gravesande, built model cars propelled by jets of steam. Rocket experimenters in Germany and Russia began working with rockets with a mass of more than 45 kilograms. Some of these rockets were so powerful that their escaping exhaust flames bored deep holes in the ground even before liftoff.

During the end of the 18th century and early into the 19th, rockets experienced a brief revival as a weapon of war. The success of Indian rocket barrages against the British in 1792 and again in 1799 caught the interest of an artillery expert, Colonel William Congreve. Congreve set out to design rockets for use by the British military.

The Congreve rockets were highly successful in battle. Used by British ships to pound Fort McHenry in the War of 1812, they inspired Francis Scott Key to write "the rockets' red glare," in his poem that later became *The Star-Spangled Banner*.

Even with Congreve's work, the accuracy of rockets still had not improved much from the early days. The devastating nature of war rockets was not their accuracy or power, but their numbers. During a typical siege, thousands of them might be fired at the enemy. All over the world, rocket researchers experimented with ways to improve accuracy. An Englishman, William Hale, developed a technique called spin stabilization. In this method, the escaping exhaust gases struck small vanes at the bottom of the rocket, causing it to spin much as a bullet does in flight. Many rockets still use variations of this principle today.

Rocket use continued to be successful in battles all over the European continent. However, in a war with Prussia, the

Austrian rocket brigades met their match against newly designed artillery pieces. Breech-loading cannon with rifled barrels and exploding warheads were far more effective weapons of war than the best rockets. Once again, the military relegated rocketry to peacetime uses.

Modern Rocketry Begins

In 1898, a Russian schoolteacher, Konstantin Tsiolkovsky (1857-1935), proposed the idea of space exploration by rocket. In a report he published in 1903, Tsiolkovsky suggested the use of liquid propellants for rockets in order to achieve greater range. Tsiolkovsky stated that only the exhaust velocity of escaping gases limited the speed and range of a rocket. For his ideas, careful research, and great vision, Tsiolkovsky has been called the father of modern astronautics.

Early in the 20th century, an American, Robert H. Goddard (1882-1945), conducted practical experiments in rocketry. He had become interested in a way of achieving higher altitudes than were possible for lighter-than-air balloons. He published a pamphlet in 1919 entitled *A Method of Reaching Extreme Altitudes*. Today we call this mathematical analysis the meteorological sounding rocket.

In his pamphlet, Goddard reached several conclusions important to rocketry. From his tests, he stated that a rocket operates with greater

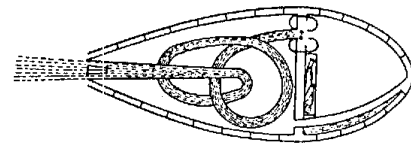

Tsiolkovsky Rocket Designs



efficiency in a vacuum than in air. At the time, most people mistakenly believed that the presence of air was necessary for a rocket to push against. A *New York Times* newspaper editorial of the day mocked Goddard's lack of the "basic physics ladled out daily in our high schools." Goddard also stated that multistage or step rockets were the answer to achieving high altitudes and that the velocity needed to escape Earth's gravity could be achieved in this way.

Goddard's earliest experiments were with solid-propellant rockets. In 1915, he began to try various types of solid fuels and to measure the exhaust velocities of the burning gases.

While working on solid-propellant rockets, Goddard became convinced that a rocket could be propelled better by liquid fuel. No one had ever built a successful liquid-propellant rocket before. It was a much more difficult task than building solid-propellant rockets. Fuel and oxygen tanks, turbines, and combustion chambers would



Dr. Robert H. Goddard makes adjustments on the upper end of a rocket combustion chamber in this 1940 picture taken in Roswell, New Mexico.

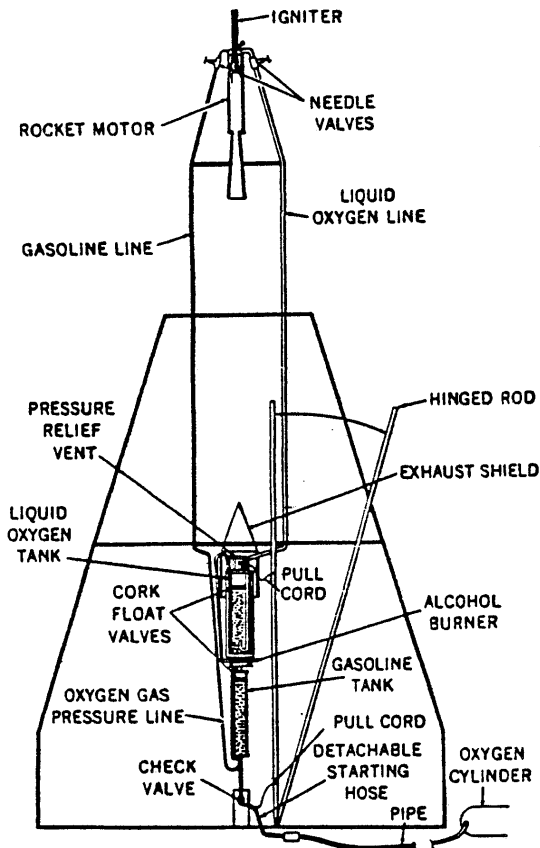

Dr. Goddard's 1926 Rocket

be needed. In spite of the difficulties, Goddard achieved the first successful flight with a liquid-propellant rocket on March 16, 1926. Fueled by liquid oxygen and gasoline, the rocket flew for only two and a half seconds, climbed 12.5 meters, and landed 56 meters away in a cabbage patch. By today's standards, the flight was unimpressive, but like the first powered airplane flight by the Wright brothers in 1903, Goddard's gasoline rocket became the forerunner of a whole new era in rocket flight.

Goddard's experiments in liquid-propellant rockets continued for many years. His rockets grew bigger and flew higher. He developed a gyroscope system for flight control and a payload compartment for scientific instruments. Parachute recovery systems returned the rockets and instruments safely to the ground. We call Goddard the father of modern rocketry for his achievements.

A third great space pioneer, Hermann Oberth (1894-1989) of Germany, published a book in 1923 about rocket travel into outer space. His writings were important. Because of them, many small rocket societies sprang up



around the world. In Germany, the formation of one such society, the Verein für Raumschiffahrt (Society for Space Travel), led to the development of the V-2 rocket, which the Germans used against London during World War II. In 1937, German engineers and scientists, including Oberth, assembled in Peenemunde on the shores of the Baltic Sea. There, under the directorship of Wernher von Braun, engineers and scientists built and flew the most advanced rocket of its time.

The V-2 rocket (in Germany called the A-4) was small by comparison to today's rockets. It achieved its great thrust by burning a mixture of liquid oxygen and alcohol at a rate of about one ton every seven seconds. Once launched, the V-2 was a formidable weapon that could devastate whole city blocks.

Fortunately for London and the Allied forces, the V-2 came too late in the war to change its outcome. Nevertheless, by war's end, German rocket scientists and engineers had already laid plans for advanced missiles capable of spanning the Atlantic Ocean and landing in the United States. These missiles would have had winged upper stages but very small payload capacities.

With the fall of Germany, the Allies captured many unused V-2 rockets and components. Many German rocket scientists came to the United States. Others went to the Soviet Union. The German scientists, including Wernher von Braun, were amazed at the progress Goddard had made.

Both the United States and the Soviet Union recognized the potential of rocketry as a military weapon and began a variety of experimental programs. At first, the United States began a program with high-altitude atmospheric sounding rockets, one of Goddard's early ideas. Later, they developed a variety of medium- and long-range intercontinental ballistic missiles. These became the starting point of the U.S. space program. Missiles such as the Redstone, Atlas, and Titan would eventually launch astronauts into space.

On October 4, 1957, the Soviet Union stunned the world by launching an Earth-orbiting artificial satellite. Called *Sputnik I*, the satellite was the first successful entry in a race for space between the two superpower nations. Less than a month later, the Soviets followed with the launch of a satellite carrying a dog named Laika on board. Laika survived in space for seven days before being put to sleep before the oxygen supply ran out.

A few months after the first *Sputnik*, the United States followed the Soviet Union with a satellite of its own. The U.S. Army

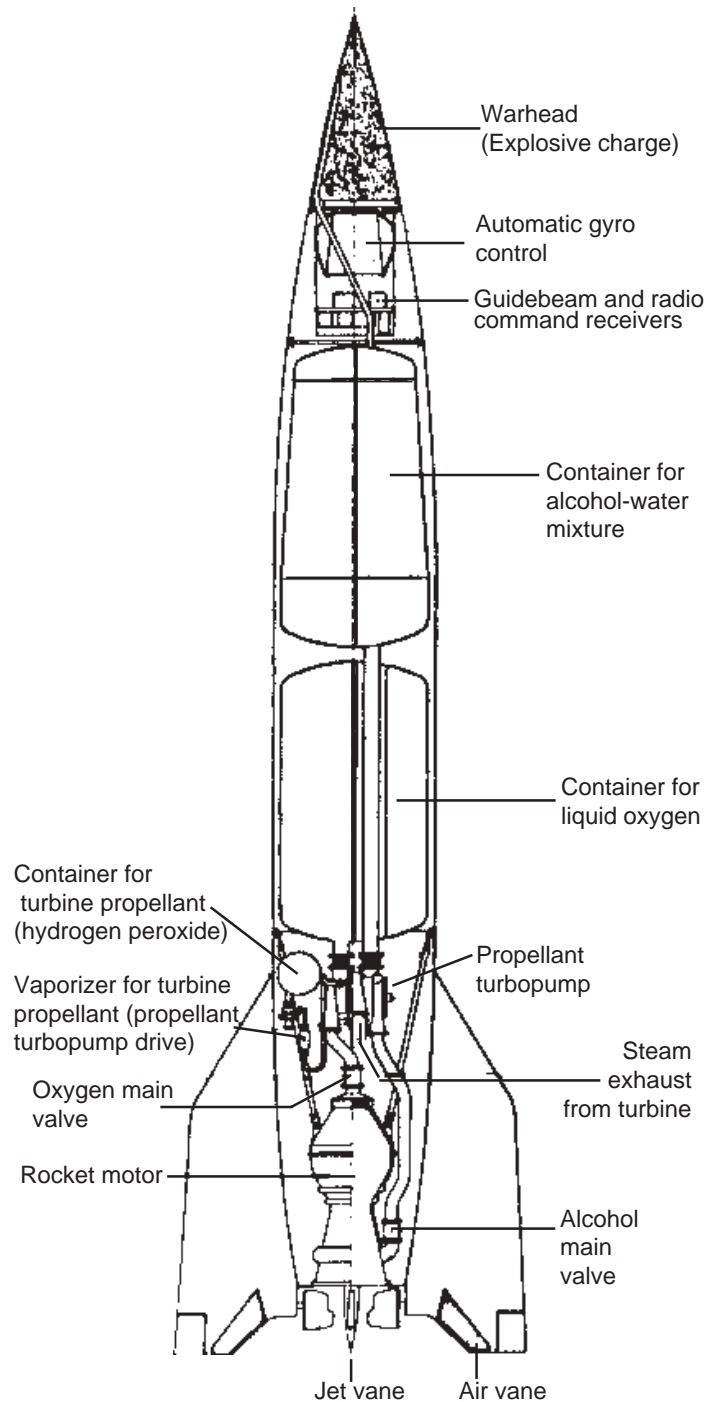

German V-2 (A-4) Missile



launched *Explorer 1* on January 31, 1958. In October of that year, the United States formally organized its space program by creating the National Aeronautics and Space Administration (NASA). NASA became a civilian agency with the goal of peaceful exploration of space for the benefit of all humankind.

Soon, rockets launched many people and machines into space. Astronauts orbited Earth and landed on the Moon. Robot spacecraft traveled to the planets. Space suddenly opened up to exploration and commercial exploitation. Satellites enabled scientists to investigate our world, forecast the weather, and communicate instantaneously around the globe. The demand for more and larger payloads created the need to develop a wide array of powerful and versatile rockets.

Scientific exploration of space using robotic spacecraft proceeded at a fast pace. Both Russia and the United States began programs to investigate the Moon. Developing the technology to physically get a probe to the Moon became the initial challenge. Within nine months of *Explorer 1* the United States launched the first unmanned lunar probe, but the launch vehicle, an Atlas with an Able upper stage, failed 45 seconds after liftoff when the payload fairing tore away from the vehicle. The Russians were more successful with *Luna 1*, which flew past the Moon in January of 1959. Later that year the *Luna* program impacted a probe on the Moon, taking the first pictures of its far side. Between 1958 and 1960 the United States sent a series of missions, the *Pioneer Lunar Probes*, to photograph and obtain scientific data about the Moon. These probes were generally unsuccessful, primarily due to launch vehicle failures. Only one of eight probes accomplished its intended mission to the Moon, though several, which were stranded in orbits between Earth and the Moon, did provide important scientific information on the number and extent of the radiation belts around Earth. The United States appeared to lag behind the Soviet Union in space.

With each launch, manned spaceflight came a step closer to becoming reality. In April of 1961, a Russian named Yuri Gagarin became the first man to orbit Earth. Less than a month later the United States launched the first American, Alan Shepard, into space. The flight was a sub-orbital lofting into space, which immediately returned to Earth. The Redstone rocket was not powerful enough to place the *Mercury* capsule into orbit. The flight lasted only a little over 15 minutes and reached an altitude of 187 kilometers. Alan Shepard experienced about

five minutes of microgravity then returned to Earth, during which he encountered forces twelve times greater than the force of gravity. Twenty days later, though still technically behind the Soviet Union, President John Kennedy announced the objective to put a man on the Moon by the end of the decade.

In February of 1962, John Glenn became the first American to orbit Earth in a small capsule so filled with equipment that he only had room to sit. Launched by the more powerful Atlas vehicle, John Glenn remained in orbit for four hours and fifty-five minutes before splashing down in the Atlantic Ocean. The *Mercury* program had a total of six launches: two suborbital and four orbital. These launches demonstrated the United States' ability to send men into orbit, allowed the crew to function in space, operate the spacecraft, and make scientific observations.

The United States then began an extensive unmanned program aimed at supporting the manned lunar landing program. Three separate projects gathered information on landing sites and other data about the lunar surface and the surrounding environment. The first was the *Ranger* series, which was the United States first attempt to

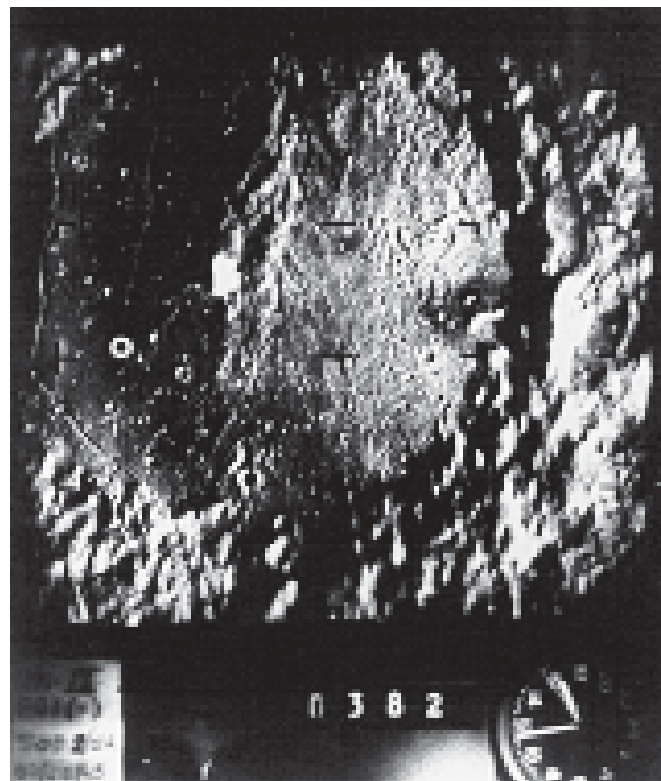

Close-up picture of the Moon taken by the *Ranger 9* spacecraft just before impact. The small circle to the left is the impact site.



take close-up photographs of the Moon. The spacecraft took thousands of black and white photographs of the Moon as it descended and crashed into the lunar surface. Though the Ranger series supplied very detailed data, mission planners for the coming *Apollo* mission wanted more extensive data.

The final two lunar programs were designed to work in conjunction with one another. *Lunar Orbiter* provided an extensive map of the lunar surface. *Surveyor* provided detailed color photographs of the lunar surface as well as data on the elements of the lunar sediment and an assessment of the ability of the sediment to support the weight of the manned landing vehicles. By examining both sets of data, planners were able to identify sites for the manned landings. However, a significant problem existed, the *Surveyor* spacecraft was too large to be launched by existing Atlas/Agona rockets, so a new high energy upper stage called the Centaur was developed to replace the Agona specifically for this mission. The Centaur upper stage used efficient hydrogen and oxygen propellants to dramatically improve its performance, but the super cold temperatures and highly explosive nature presented significant technical challenges. In addition, they built the tanks of the Centaur with thin stainless steel to save precious weight. Moderate pressure had to be maintained in the tank to prevent it from collapsing upon itself. Rocket building was refining the United State's capability to explore the Moon.

The *Gemini* was the second manned capsule developed by the United States. It was designed to carry two crew members and was launched on the largest launch vehicle available—the Titan II. President Kennedy's mandate significantly altered the *Gemini* mission from the general goal of expanding experience in space to prepare for a manned lunar landing on the Moon. It paved the way for the *Apollo* program by demonstrating rendezvous and docking required for the lunar lander to return to the lunar orbiting spacecraft, the extravehicular activity (EVA) required for the lunar surface exploration and any emergency repairs, and finally the ability of humans to function during the eight day manned lunar mission duration. The *Gemini* program launched ten manned missions in 1965 and 1966, eight flights rendezvous and docked with unmanned stages in Earth orbit and seven performed EVA.

Launching men to the moon required launch vehicles much larger than those available. To achieve this goal the United States

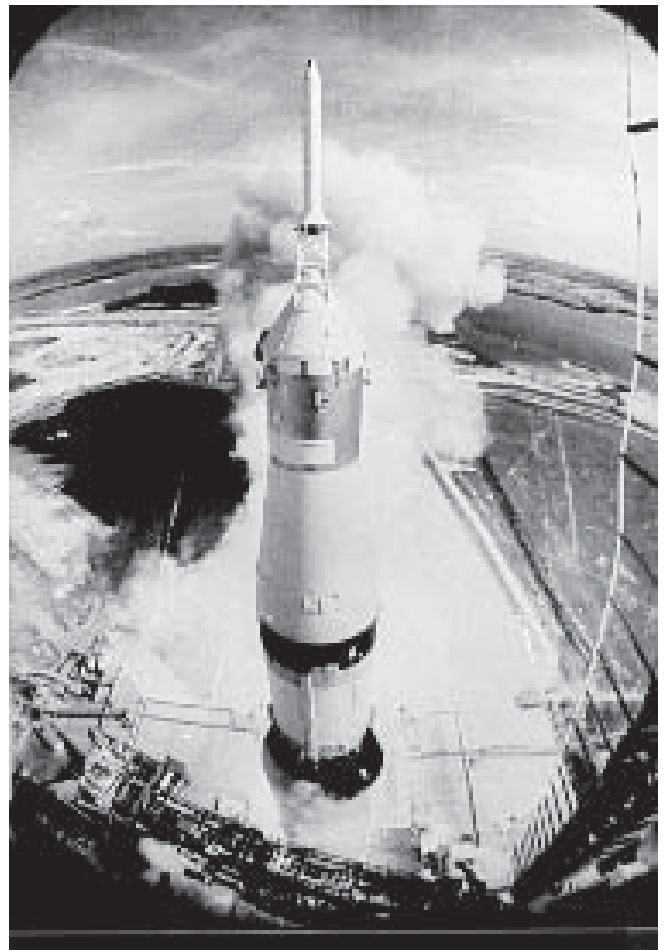

A fish-eye camera view of a Saturn 5 rocket just after engine ignition.

developed the Saturn launch vehicle. The *Apollo* capsule, or command module, held a crew of three. The capsule took the astronauts into orbit about the Moon, where two astronauts transferred into a lunar module and descended to the lunar surface. After completing the lunar mission, the upper section of the lunar module returned to orbit to rendezvous with the *Apollo* capsule. The Moonwalkers transferred back to the command module and a service module, with an engine, propelled them back to Earth. After four manned test flights, *Apollo 11* astronaut Neil Armstrong became the first man on the moon. The United States returned to the lunar surface five more times before the manned lunar program was completed. After the lunar program the *Apollo* program and the Saturn booster launched *Skylab*, the United State's first space station. A smaller version of the Saturn vehicle transported the United States' crew for the first rendezvous in space between the United States and Russia on the *Apollo-Soyuz* mission.



During this manned lunar program, unmanned launch vehicles sent many satellites to investigate our planet, forecast the weather, and communicate instantaneously around the world. In addition, scientists began to explore other planets. *Mariner 2* successfully flew by Venus in 1962, becoming the first probe to fly past another planet. The United State's interplanetary space program then took off with an amazing string of successful launches. The program has visited every planet except Pluto.

After the *Apollo* program the United States began concentrating on the development of a reusable launch system, the Space Shuttle. Solid rocket boosters and three main engines on the orbiter launch the Space Shuttle. The reusable boosters jettison little more than 2 minutes into the flight, their fuel expended. Parachutes deploy to decelerate the solid rocket boosters for a safe splashdown in the Atlantic ocean, where two ships recover them. The orbiter and external tank continue to ascend. When the main engines shut down, the external tank jettisons from the orbiter, eventually disintegrating in the atmosphere. A brief firing of the spacecraft's two orbital maneuvering system thrusters changes the trajectory to achieve orbit at a range of 185-402 kilometers above Earth's surface. The Space Shuttle orbiter can carry approximately 25,000 kilograms of payload into orbit so crew members can conduct experiments in a microgravity environment. The orbital maneuvering system thrusters fire to slow the spacecraft for reentry into Earth's atmosphere, heating up the orbiter's thermal protection shield up to 816° Celsius. On the Shuttle's final descent, it returns to Earth gliding like an airplane.

Since the earliest days of discovery and experimentation, rockets have evolved from simple gunpowder devices into giant vehicles capable of traveling into outer space, taking astronauts to the Moon, launching satellites to explore our universe, and enabling us to conduct scientific experiments aboard the Space Shuttle. Without a doubt rockets have opened the universe to direct exploration by humankind. What role will rockets play in our future?

The goal of the United States space program is to expand our horizons in space, and then to open the space frontier to international human expansion and the commercial development. For

this to happen, rockets must become more cost effective and more reliable as a means of getting to space. Expensive hardware cannot be thrown away each time we go to space. It is necessary to continue the drive for more reusability started during the Space Shuttle program. Eventually NASA may develop aerospace planes that will take off from runways, fly into orbit, and land on those same runways, with operations similar to airplanes.

To achieve this goal two programs are currently under development. The X33 and X34 programs will develop reusable vehicles, which significantly decrease the cost to orbit. The X33 will be a manned vehicle lifting about the same payload capacity as the Space Shuttle. The X34 will be a small, reusable unmanned launch vehicle capable of launching 905 kilograms to space and reduce the launch cost relative to current vehicles by two thirds.

The first step towards building fully reusable vehicles has already occurred. A project called the Delta Clipper is currently being tested. The Delta Clipper is a vertical takeoff and soft landing vehicle. It has demonstrated the ability to hover and maneuver over Earth using the same hardware over and over again. The program uses much existing technology and minimizes the operating cost. Reliable, inexpensive rockets are the key to enabling humans to truly expand into space.

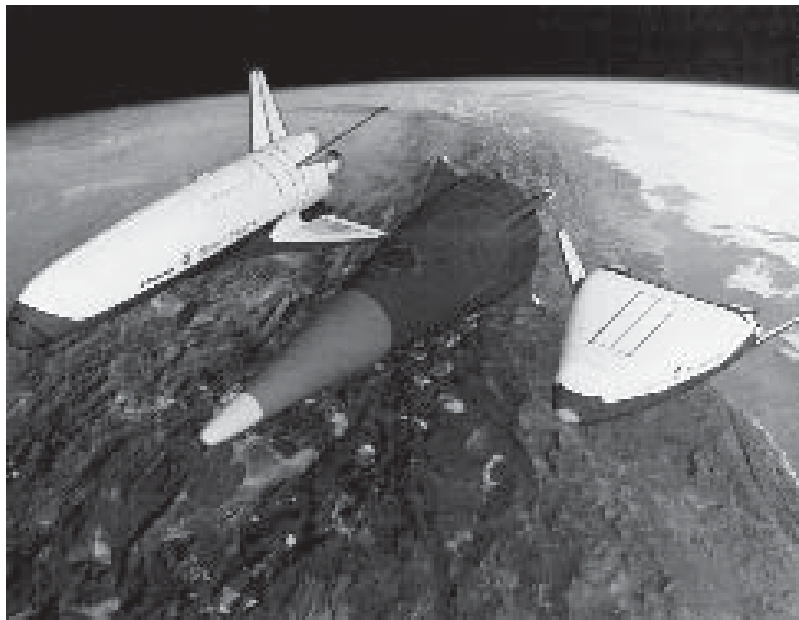

Three reusable future space vehicles concepts under consideration by NASA.



Rocket Principles

A rocket in its simplest form is a chamber enclosing a gas under pressure. A small opening at one end of the chamber allows the gas to escape, and in doing so provides a thrust that propels the rocket in the opposite direction. A good example of this is a balloon. Air inside a balloon is compressed by the balloon's rubber walls. The air pushes back so that the inward and outward pressing forces balance. When the nozzle is released, air escapes through it and the balloon is propelled in the opposite direction.

When we think of rockets, we rarely think of balloons. Instead, our attention is drawn to the giant vehicles that carry satellites into orbit and spacecraft to the Moon and planets. Nevertheless, there is a strong similarity between the two.

The only significant difference is the way the pressurized gas is produced. With space rockets, the gas is produced by burning propellants that can be solid or liquid in form or a combination of the two.

One of the interesting facts about the historical development of rockets is that while rockets and rocket-powered devices have been in use for more than two thousand years, it has been only in the last three hundred years that rocket experimenters have had a scientific basis for understanding how they work.

The science of rocketry began with the publishing of a book in 1687 by the great English scientist Sir Isaac Newton. His book, entitled *Philosophiæ Naturalis Principia Mathematica*, described physical principles in nature. Today, Newton's work is usually just called the *Principia*.

In the *Principia*, Newton stated three important scientific principles that govern the motion of all objects, whether on Earth or in space. Knowing these principles, now called Newton's Laws of Motion, rocketeers have been able to construct the modern giant rockets of the 20th century such as the Saturn 5 and the Space Shuttle. Here now, in simple form, are Newton's Laws of Motion.

1. Objects at rest will stay at rest and objects in motion will stay in motion in a straight line unless acted upon by an unbalanced force.

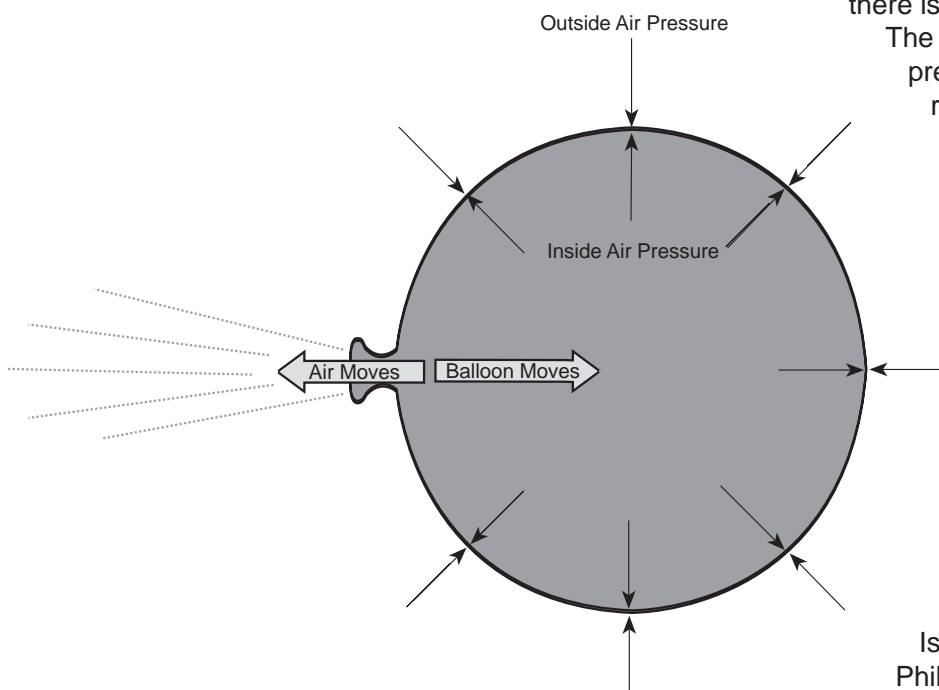

2. Force is equal to mass times acceleration.
3. For every action there is always an opposite and equal reaction.

As will be explained shortly, all three laws are really simple statements of how things move. But with them, precise determinations of rocket performance can be made.

Newton's First Law

This law of motion is just an obvious statement of fact, but to know what it means, it is necessary to understand the terms *rest*, *motion*, and *unbalanced force*.

Rest and motion can be thought of as being opposite to each other. Rest is the state of an object when it is not changing position in relation to its surroundings. If you are sitting still in a chair, you can be said to be at rest. This term, however, is relative. Your chair may actually be one of many seats on a speeding airplane. The important thing to remember here is that you are not moving *in relation to your immediate surroundings*. If rest were defined as a total absence of motion, it would not exist in nature. Even if you were sitting in your chair at home, you would still be moving, because your chair is actually sitting on the surface of a spinning planet that is orbiting a star. The star is moving through a rotating galaxy that is, itself, moving through the universe. While sitting "still," you are, in fact, traveling at a speed of hundreds of kilometers per second.

Motion is also a relative term. All matter in the universe is moving all the time, but in the first law, motion here means changing position in relation to surroundings. A ball is at rest if it is sitting on the ground. The ball is in motion if it is rolling. A rolling ball changes its position in relation to its surroundings. When you are sitting on a chair in an airplane, you are at rest, but if you get up and walk down the aisle, you are in motion. A rocket blasting off the launch pad changes from a state of rest to a state of motion.

The third term important to understanding this law is unbalanced force. If you hold a ball in your hand and keep it still, the ball is at rest. All the time the ball is held there though, it is being acted upon by forces. The force of gravity is trying to pull the ball downward, while at the same time your hand is pushing against the ball to hold it up. The forces acting on the ball are balanced. Let the ball go, or move your hand upward, and the forces

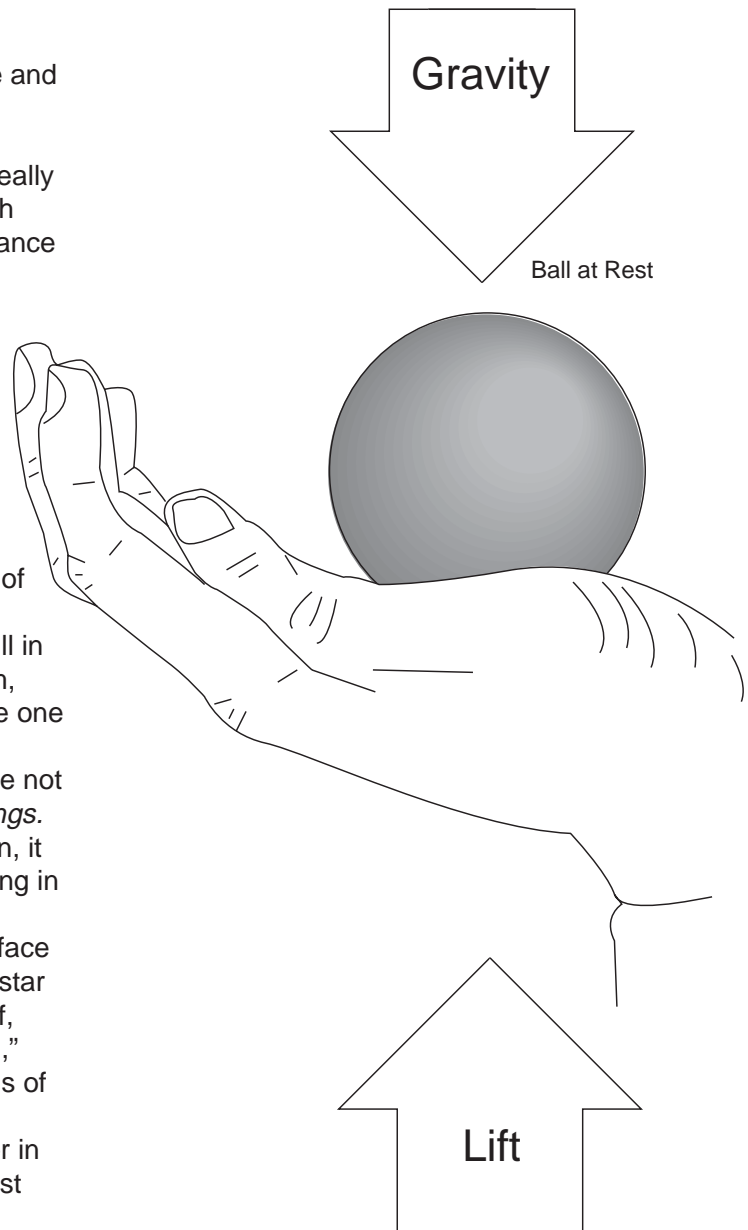

become unbalanced. The ball then changes from a state of rest to a state of motion.

In rocket flight, forces become balanced and unbalanced all the time. A rocket on the launch pad is balanced. The surface of the pad pushes the rocket up while gravity tries to pull it down. As the engines are ignited, the thrust from the rocket unbalances the forces, and the rocket travels upward. Later, when the rocket runs out of fuel, it slows down, stops at the highest point of its flight, and then falls back to Earth.

Objects in space also react to forces. A spacecraft moving through the solar system is in constant motion. The spacecraft will travel



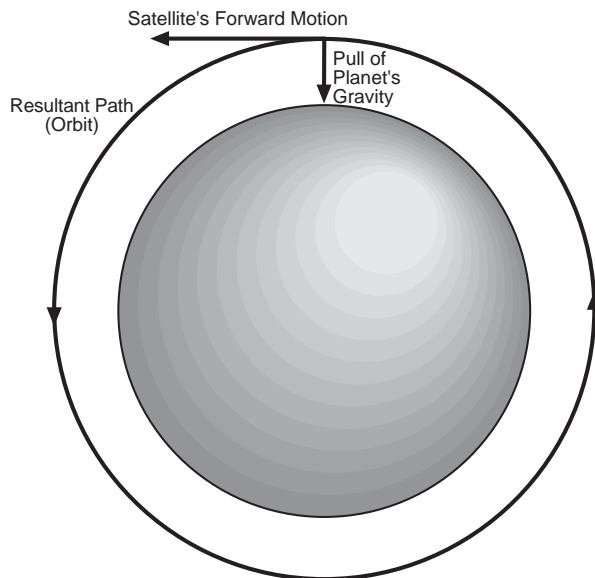

The combination of a satellite's forward motion and the pull of gravity of the planet, bend the satellite's path into an orbit.

in a straight line if the forces on it are in balance. This happens only when the spacecraft is very far from any large gravity source such as Earth or the other planets and their moons. If the spacecraft comes near a large body in space, the gravity of that body will unbalance the forces and curve the path of the spacecraft. This happens, in particular, when a satellite is sent by a rocket on a path that is tangent to the planned orbit about a planet. The unbalanced gravitational force causes the satellite's path to change to an arc. The arc is a combination of the satellite's fall inward toward the planet's center and its forward motion. When these two motions are just right, the shape of the satellite's path matches the shape of the body it is traveling around. Consequently, an orbit is produced. Since the gravitational force changes with height above a planet, each altitude has its own unique velocity that results in a circular orbit. Obviously, controlling velocity is extremely important for maintaining the circular orbit of the spacecraft. Unless another unbalanced force, such as friction with gas

molecules in orbit or the firing of a rocket engine in the opposite direction, slows down the spacecraft, it will orbit the planet forever.

Now that the three major terms of this first law have been explained, it is possible to restate this law. If an object, such as a rocket, is at rest, it takes an unbalanced force to make it move. If the object is already moving, it takes an unbalanced force, to stop it, change its direction from a straight line path, or alter its speed.

Newton's Third Law

For the time being, we will skip the Second Law and go directly to the Third. This law states that every action has an equal and opposite reaction. If you have ever stepped off a small boat that has not been properly tied to a pier, you will know exactly what this law means.

A rocket can liftoff from a launch pad only when it expels gas out of its engine. The rocket pushes on the gas, and the gas in turn pushes on the rocket. The whole process is very similar to riding a skateboard. Imagine that a skateboard and rider are in a state of rest (not moving). The rider jumps off the skateboard. In the Third Law, the jumping is called an *action*. The skateboard responds to that action by traveling some distance in the opposite direction. The skateboard's opposite motion is called a *reaction*. When the distance traveled by the rider and the skateboard are compared, it would appear that the skateboard has had a much greater reaction than the action of the rider. This is not the case. The reason the

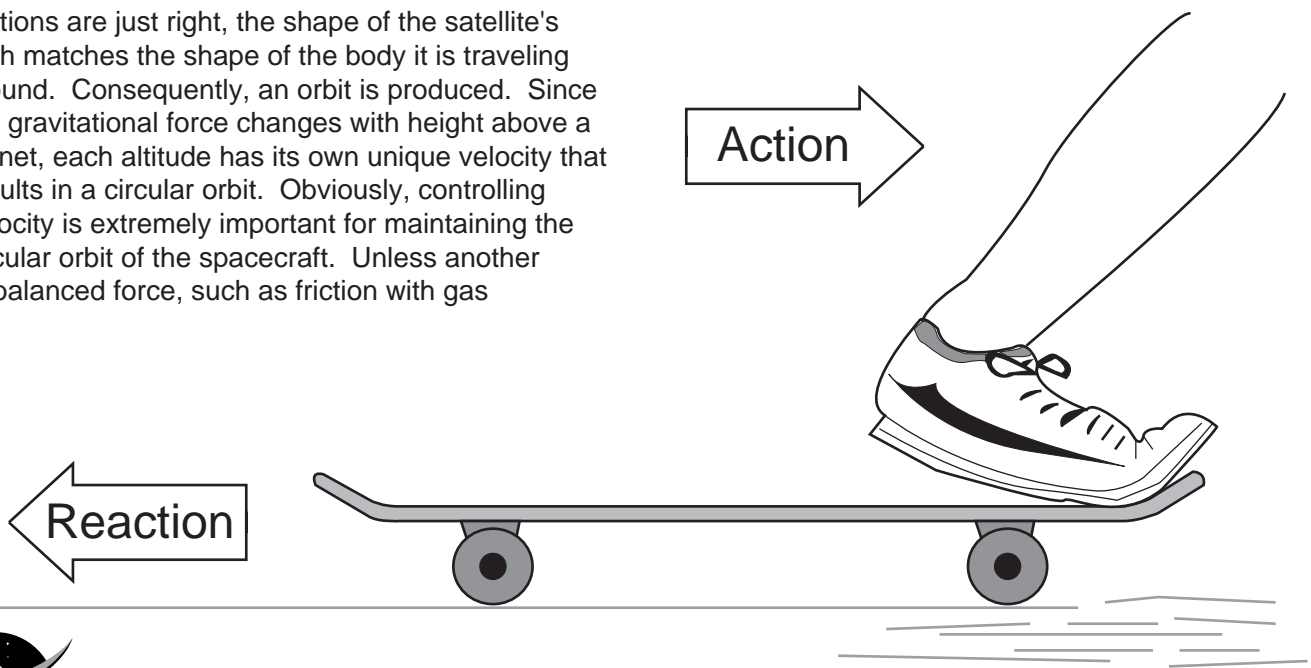

skateboard has traveled farther is that it has less mass than the rider. This concept will be better explained in a discussion of the Second Law.

With rockets, the action is the expelling of gas out of the engine. The reaction is the movement of the rocket in the opposite direction. To enable a rocket to lift off from the launch pad, the action, or thrust, from the engine must be greater than the weight of the rocket. While on the pad the weight of the rocket is balanced by the force of the ground pushing against it. Small amounts of thrust result in less force required by the ground to keep the rocket balanced. Only when the thrust is greater than the weight of the rocket does the force become unbalanced and the rocket lifts off. In space where unbalanced force is used to maintain the orbit, even tiny thrusts will cause a change in the unbalanced force and result in the rocket changing speed or direction.

One of the most commonly asked questions about rockets is how they can work in space where there is no air for them to push against. The answer to this question comes from the Third Law. Imagine the skateboard again. On the ground, the only part air plays in the motions of the rider and the skateboard is to slow them down. Moving through the air causes friction, or as scientists call it, *drag*. The surrounding air impedes the action-reaction.

As a result rockets actually work better in space than they do in air. As the exhaust gas leaves the rocket engine it must push away the surrounding air; this uses up some of the energy of the rocket. In space, the exhaust gases can escape freely.

Newton's Second Law

This law of motion is essentially a statement of a mathematical equation. The three parts of the equation are mass (*m*), acceleration (*a*), and force (*f*). Using letters to symbolize each part, the equation can be written as follows:

$$f = ma$$

The equation reads: force equals mass times acceleration. To explain this law, we will use an old style cannon as an example.

When the cannon is fired, an explosion propels a cannon ball out the open end of the barrel. It flies a kilometer or two to its target. At the same time the

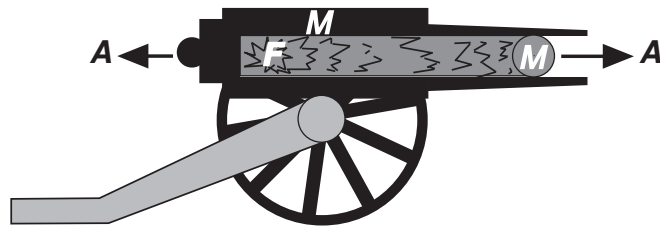

cannon itself is pushed backward a meter or two. This is action and reaction at work (Third Law). The force acting on the cannon and the ball is the same. What happens to the cannon and the ball is determined by the Second Law. Look at the two equations below.

$$f = m_{(cannon)} a_{(cannon)}$$

$$f = m_{(ball)} a_{(ball)}$$

The first equation refers to the cannon and the second to the cannon ball. In the first equation, the mass is the cannon itself and the acceleration is the movement of the cannon. In the second equation the mass is the cannon ball and the acceleration is its movement. Because the force (exploding gun powder) is the same for the two equations, the equations can be combined and rewritten below.

$$m_{(cannon)} a_{(cannon)} = m_{(ball)} a_{(ball)}$$

In order to keep the two sides of the equations equal, the accelerations vary with mass. In other words, the cannon has a large mass and a small acceleration. The cannon ball has a small mass and a large acceleration.

Apply this principle to a rocket. Replace the mass of the cannon ball with the mass of the gases being ejected out of the rocket engine. Replace the mass of the cannon with the mass of the rocket moving in the other direction. Force is the pressure created by the controlled explosion taking place inside the rocket's engines. That pressure accelerates the gas one way and the rocket the other.

Some interesting things happen with rockets that do not happen with the cannon and ball in this example. With the cannon and cannon ball, the thrust lasts for just a moment. The thrust for the rocket continues as long as its engines are



firing. Furthermore, the mass of the rocket changes during flight. Its mass is the sum of all its parts. Rocket parts include: engines, propellant tanks, payload, control system, and propellants. By far, the largest part of the rocket's mass is its propellants. But that amount constantly changes as the engines fire. That means that the rocket's mass gets smaller during flight. In order for the left side of our equation to remain in balance with the right side, acceleration of the rocket has to increase as its mass decreases. That is why a rocket starts off moving slowly and goes faster and faster as it climbs into space.

Newton's Second Law of Motion is especially useful when designing efficient rockets. To enable a rocket to climb into low Earth orbit, it is necessary to achieve a speed, in excess of 28,000 km per hour. A speed of over 40,250 km per hour, called escape velocity, enables a rocket to leave Earth and travel out into deep space. Attaining space flight speeds requires the rocket engine to achieve the greatest action force possible in the shortest time. In other words, the engine must burn a large mass of fuel and push the resulting gas out of the engine as rapidly as possible. Ways of doing this will be described in the next chapter.

Newton's Second Law of Motion can be restated in the following way: the greater the mass of rocket fuel burned, and the faster the gas produced can escape the engine, the greater the thrust of the rocket.

Putting Newton's Laws of Motion Together

An unbalanced force must be exerted for a rocket to lift off from a launch pad or for a craft in space to change speed or direction (First Law). The amount of thrust (force) produced by a rocket engine will be determined by the rate at which the mass of the rocket fuel burns and the speed of the gas escaping the rocket (Second Law). The reaction, or motion, of the rocket is equal to and in the opposite direction of the action, or thrust, from the engine (Third Law).



Practical Rocketry

The first rockets ever built, the fire-arrows of the Chinese, were not very reliable. Many just exploded on launching. Others flew on erratic courses and landed in the wrong place. Being a rocketeer in the days of the fire-arrows must have been an exciting, but also a highly dangerous activity.

Today, rockets are much more reliable. They fly on precise courses and are capable of going fast enough to escape the gravitational pull of Earth. Modern rockets are also more efficient today because we have an understanding of the scientific principles behind rocketry. Our understanding has led us to develop a wide variety of advanced rocket hardware and devise new propellants that can be used for longer trips and more powerful takeoffs.

Rocket Engines and Their Propellants

Most rockets today operate with either solid or liquid propellants. The word *propellant* does not mean simply fuel, as you might think; it means both *fuel* and *oxidizer*. The fuel is the chemical the rocket burns but, for burning to take place, an oxidizer (oxygen) must be present. Jet engines draw oxygen into their engines from the surrounding air. Rockets do not have the luxury that jet planes have; they must carry oxygen with them into space, where there is no air.

Solid rocket propellants, which are dry to the touch, contain both the fuel and oxidizer combined together in the chemical itself. Usually the fuel is a mixture of hydrogen compounds and carbon and the oxidizer is made up of oxygen compounds. Liquid propellants, which are often gases that have been chilled until they turn into liquids, are kept in separate containers, one for the fuel and the other for the oxidizer. Just before firing, the fuel and oxidizer are mixed together in the engine.

A *solid-propellant rocket* has the simplest form of engine. It has a *nozzle*, a *case*, *insulation*, *propellant*, and an *igniter*. The case of the engine is usually a relatively thin metal that is lined with insulation to keep the propellant from burning through. The propellant itself is packed inside the insulation layer.

Many solid-propellant rocket engines feature a hollow core that runs through the propellant. Rockets that do not have the hollow core must be ignited at the lower end of the propellants and burning proceeds gradually from one end of the rocket to the other. In all cases, only the surface of the propellant burns. However, to get higher thrust, the hollow core is used. This increases the



surface of the propellants available for burning. The propellants burn from the inside out at a much higher rate, sending mass out the nozzle at a higher rate and speed. This results in greater thrust. Some propellant cores are star shaped to increase the burning surface even more.

To ignite solid propellants, many kinds of igniters can be used. Fire-arrows were ignited by fuses, but sometimes these ignited too quickly and burned the rocketeer. A far safer and more reliable form of ignition used today is one that employs electricity. An electric current, coming through wires from some distance away, heats up a special wire inside the rocket. The wire raises the temperature of the propellant it is in contact with to the combustion point.

Other igniters are more advanced than the hot wire device. Some are encased in a chemical that ignites first, which then ignites the propellants. Still other igniters, especially those for large rockets, are rocket engines themselves. The small engine inside the hollow core blasts a stream of flames and hot gas down from the top of the core and ignites the entire surface area of the propellants in a fraction of a second.

The nozzle in a solid-propellant engine is an opening at the back of the rocket that permits the hot expanding gases to escape. The narrow part of the nozzle is the *throat*. Just beyond the throat is the exit cone.

The purpose of the nozzle is to increase the acceleration of the gases as they leave the rocket and thereby maximize the thrust. It does this by cutting down the opening through which the gases can escape. To see how this works, you can experiment with a garden hose that has a spray nozzle attachment. This kind of nozzle does not have an exit cone, but that does not matter in the experiment. The important point about the nozzle is that the size of the opening can be varied.

Start with the opening at its widest point. Watch how far the water squirts and feel the thrust produced by the departing water. Now reduce the diameter of the opening, and again note the distance the water squirts and feel the thrust. Rocket nozzles work the same way.

As with the inside of the rocket case, insulation is needed to protect the nozzle from the hot gases. The usual insulation is one that gradually erodes as the gas passes through. Small pieces of the insulation get very hot and break away from the nozzle. As they are blown away, heat is carried away with them.

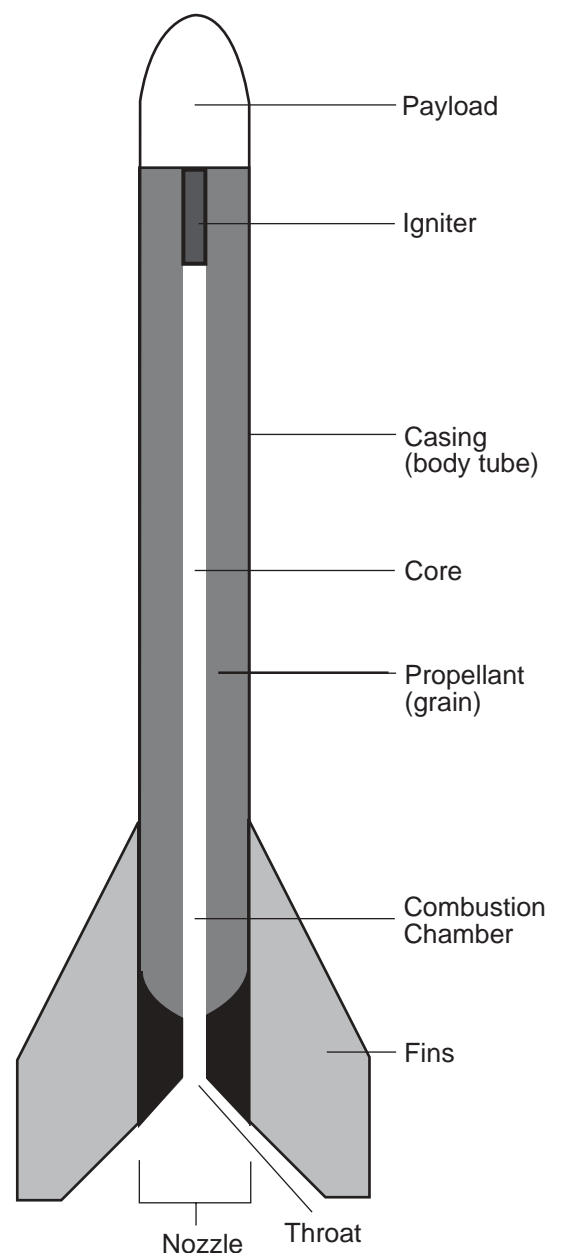

Solid Propellant Rocket

The other main kind of rocket engine is one that uses liquid propellants, which may be either pumped or fed into the engine by pressure. This is a much more complicated engine, as is evidenced by the fact that solid rocket engines were used for at least seven hundred years before the first successful liquid engine was tested. Liquid propellants have separate storage tanks—one for the fuel and one for the oxidizer. They also have a *combustion chamber*, and a nozzle.



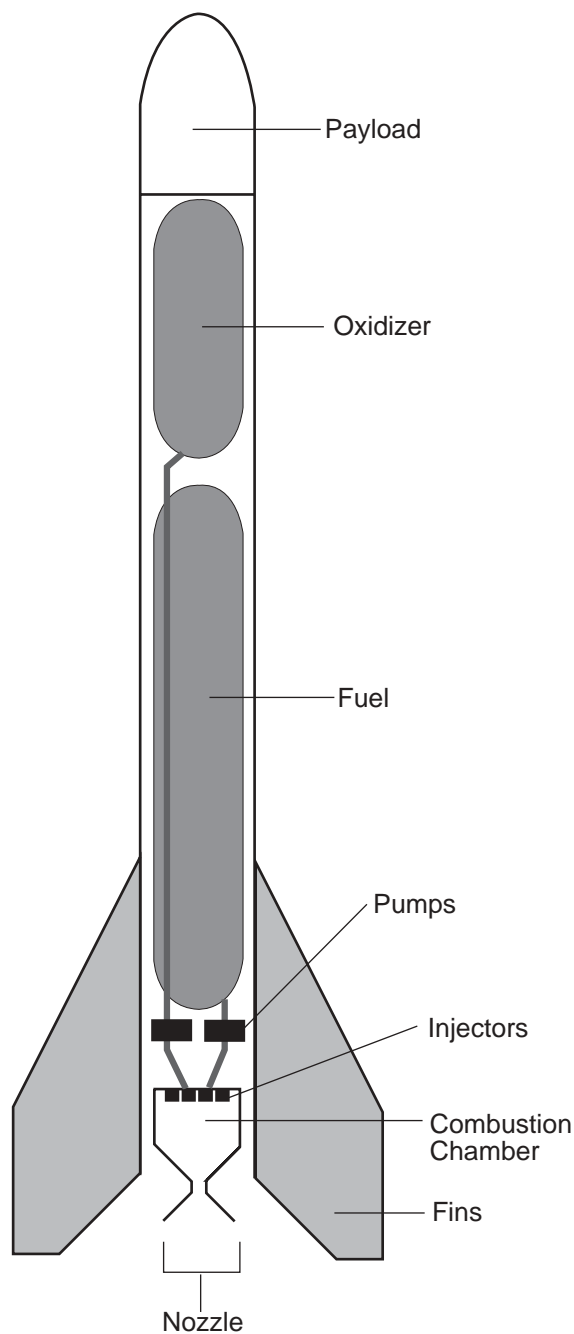

Liquid Propellant Rocket

The fuel of a liquid-propellant rocket is usually kerosene or liquid hydrogen; the oxidizer is usually liquid oxygen. They are combined inside a cavity called the combustion chamber. Here the propellants burn and build up high temperatures and pressures, and the expanding gas escapes through the nozzle at the lower end. To get the most power from the propellants, they must be mixed as completely as possible. Small *injectors* (nozzles) on the roof of the chamber spray and mix the propellants at the same time. Because the

chamber operates under high pressures, the propellants need to be forced inside. Modern liquid rockets use powerful, lightweight turbine pumps to take care of this job.

With any rocket, and especially with liquid-propellant rockets, weight is an important factor. In general, the heavier the rocket, the more the thrust needed to get it off the ground. Because of the pumps and fuel lines, liquid engines are much heavier than solid engines.

One especially good method of reducing the weight of liquid engines is to make the exit cone of the nozzle out of very lightweight metals. However, the extremely hot, fast-moving gases that pass through the cone would quickly melt thin metal. Therefore, a cooling system is needed. A highly effective though complex cooling system that is used with some liquid engines takes advantage of the low temperature of liquid hydrogen. Hydrogen becomes a liquid when it is chilled to -253°C . Before injecting the hydrogen into the combustion chamber, it is first circulated through small tubes that lace the walls of the exit cone. In a cutaway view, the exit cone wall looks like the edge of corrugated cardboard. The hydrogen in the tubes absorbs the excess heat entering the cone walls and prevents it from melting the walls away. It also makes the hydrogen more energetic because of the heat it picks up. We call this kind of cooling system *regenerative cooling*.

Engine Thrust Control

Controlling the thrust of an engine is very important to launching payloads (cargoes) into orbit. Thrusting for too short or too long of a period of time will cause a satellite to be placed in the wrong orbit. This could cause it to go too far into space to be useful or make the satellite fall back to Earth. Thrusting in the wrong direction or at the wrong time will also result in a similar situation.

A computer in the rocket's guidance system determines when that thrust is needed and turns the engine on or off appropriately. Liquid engines do this by simply starting or stopping the flow of propellants into the combustion chamber. On more complicated flights, such as going to the Moon, the engines must be started and stopped several times.

Some liquid-propellant engines control the amount of engine thrust by varying the amount of propellant that enters the combustion chamber. Typically the engine thrust varies for controlling the acceleration experienced by astronauts or to limit the aerodynamic forces on a vehicle.



Solid-propellant rockets are not as easy to control as liquid rockets. Once started, the propellants burn until they are gone. They are very difficult to stop or slow down part way into the burn. Sometimes fire extinguishers are built into the engine to stop the rocket in flight. But using them is a tricky procedure and does not always work. Some solid-fuel engines have hatches on their sides that can be cut loose by remote control to release the chamber pressure and terminate thrust.

The burn rate of solid propellants is carefully planned in advance. The hollow core running the length of the propellants can be made into a star shape. At first, there is a very large surface available for burning, but as the points of the star burn away, the surface area is reduced. For a time, less of the propellant burns, and this reduces thrust. The *Space Shuttle* uses this technique to reduce vibrations early in its flight into orbit.

NOTE: Although most rockets used by governments and research organizations are very reliable, there is still great danger associated with the building and firing of rocket engines. Individuals interested in rocketry should **never** attempt to build their own engines. Even the simplest-looking rocket engines are very complex. Case-wall bursting strength, propellant packing density, nozzle design, and propellant chemistry are all design problems beyond the scope of most amateurs. Many home-built rocket engines have exploded in the faces of their builders with tragic consequences.

Stability and Control Systems

Building an efficient rocket engine is only part of the problem in producing a successful rocket. The rocket must also be stable in flight. A stable rocket is one that flies in a smooth, uniform direction. An unstable rocket flies along an erratic path, sometimes tumbling or changing direction. Unstable rockets are dangerous because it is not possible to predict where they will go. They may even turn upside down and suddenly head back directly to the launch pad.

Making a rocket stable requires some form of control system. Controls can be either active or passive. The difference between these and how they work will be explained later. It is first important to understand what makes a rocket stable or unstable.

All matter, regardless of size, mass, or shape, has a point inside called the *center of mass* (CM). The center of mass is the exact

spot where all of the mass of that object is perfectly balanced. You can easily find the center of mass of an object such as a ruler by balancing the object on your finger. If the material used to make the ruler is of uniform thickness and density, the center of mass should be at the halfway point between one end of the stick and the other. If the ruler were made of wood, and a heavy nail were driven into one of its ends, the center of mass would no longer be in the middle. The balance point would then be nearer the end with the nail.

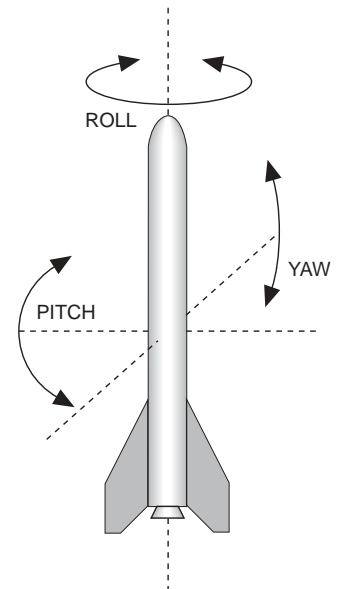

The center of mass is important in rocket flight because it is around this point that an unstable rocket tumbles. As a matter of fact, any object in flight tends to tumble. Throw a stick, and it tumbles end over end. Throw a ball, and it spins in flight. The act of spinning or tumbling is a way of becoming stabilized in flight. A Frisbee will go where you want it to only if you throw it with a deliberate spin. Try throwing a Frisbee without spinning it. If you succeed, you will see that the Frisbee flies in an erratic path and falls far short of its mark.

In flight, spinning or tumbling takes place around one or more of three axes. They are called *roll*, *pitch*, and *yaw*. The point where all three of these axes intersect is the center of mass. For

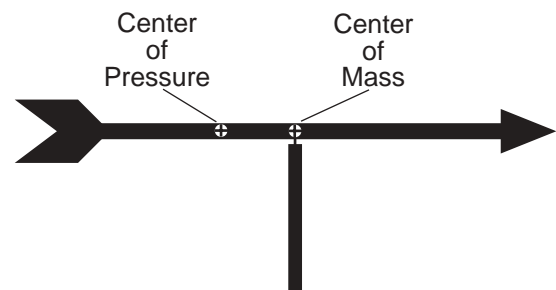

rocket flight, the pitch and yaw axes are the most important because any movement in either of these two directions can cause the rocket to go off course. The roll axis is the least important because movement along this axis will not affect the flight path. In fact, a rolling motion will help stabilize the



rocket in the same way a properly passed football is stabilized by rolling (spiraling) it in flight. Although a poorly passed football may still fly to its mark even if it tumbles rather than rolls, a rocket will not. The action-reaction energy of a football pass will be completely expended by the thrower the moment the ball leaves the hand. With rockets, thrust from the engine is still being produced while the rocket is in flight. Unstable motions about the pitch and yaw axes will cause the rocket to leave the planned course. To prevent this, a control system is needed to prevent or at least minimize unstable motions.

In addition to center of mass, there is another important center inside the rocket that affects its flight. This is the *center of pressure* (CP). The center of pressure exists only when air is flowing past the moving rocket. This flowing air, rubbing and pushing against the outer surface of the rocket, can cause it to begin moving around one of its three axes. Think for a moment of a weather vane. A weather vane is an arrow-like stick that is mounted on a rooftop and used for telling wind direction. The arrow is attached to a vertical rod that acts as a pivot point. The arrow is balanced so that the center of mass is right at the pivot point. When the wind blows, the arrow turns, and the head of the arrow points into the oncoming wind. The tail of the arrow points in the downwind direction.

The reason that the weather vane arrow points into the wind is that the tail of the arrow has a much larger surface area than the arrowhead. The flowing air imparts a greater force to the tail than the head, and therefore the tail is pushed away. There is a point on the arrow where the surface area is the same on one side as the other. This spot is called the center of pressure. The center of pressure is not in the same place as the center of mass. If it were, then neither end of the arrow would be favored by the wind and the arrow would not point. The center of pressure is between the center of mass and the tail end of the arrow. This means that the tail end has more surface area than the head end.

It is extremely important that the center of pressure in a rocket be located toward the tail and the center of mass be located toward the nose. If they are in the same place or very near each other, then the rocket will be unstable in flight. The rocket will then try to rotate about the center of mass in the pitch and yaw axes, producing a dangerous situation. With the center of pressure located in the right place, the rocket will remain stable.

Control systems for rockets are intended to keep a rocket stable in flight and to steer it. Small

rockets usually require only a stabilizing control system. Large rockets, such as the ones that launch satellites into orbit, require a system that not only stabilizes the rocket, but also enable it to change course while in flight.

Controls on rockets can either be active or passive. *Passive controls* are fixed devices that keep rockets stabilized by their very presence on the rocket's exterior. *Active controls* can be moved while the rocket is in flight to stabilize and steer the craft.

The simplest of all passive controls is a stick. The Chinese fire-arrows were simple rockets mounted on the ends of sticks. The stick kept the center of pressure behind the center of mass. In spite of this, fire-arrows were notoriously inaccurate. Before the center of pressure could take effect, air had to be flowing past the rocket. While still on the ground and immobile, the arrow might lurch and fire the wrong way.

Years later, the accuracy of fire-arrows was improved considerably by mounting them in a trough aimed in the proper direction. The trough

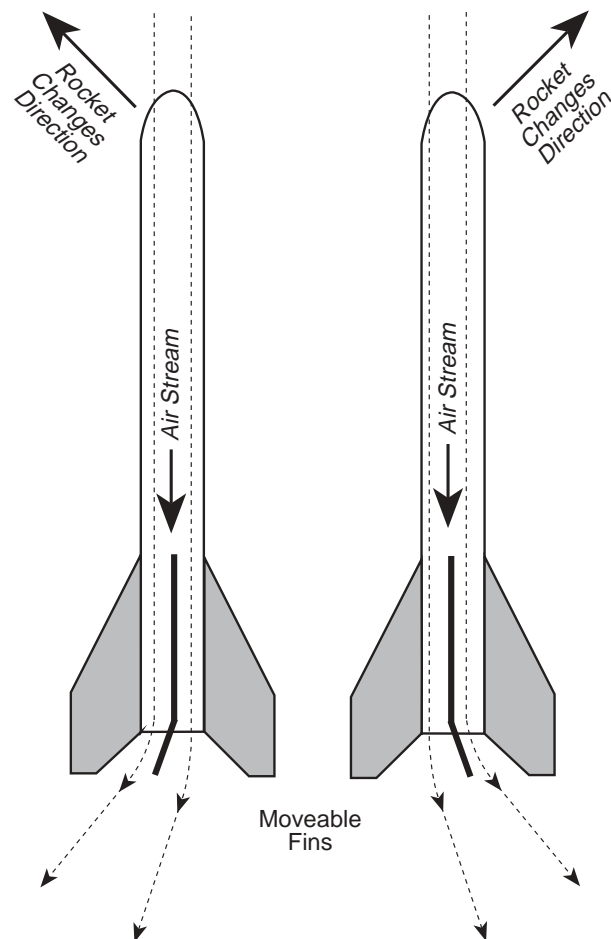

guided the arrow in the right direction until it was moving fast enough to be stable on its own.

As will be explained in the next section, the weight of the rocket is a critical factor in performance and range. The fire-arrow stick added too much dead weight to the rocket, and therefore limited its range considerably.

An important improvement in rocketry came with the replacement of sticks by clusters of lightweight fins mounted around the lower end near the nozzle. Fins could be made out of lightweight materials and be streamlined in shape. They gave rockets a dart-like appearance. The large surface area of the fins easily kept the center of pressure behind the center of mass. Some experimenters even bent the lower tips of the fins in a pinwheel fashion to promote rapid spinning in flight. With these "spin fins," rockets become much more stable in flight. But this design also produces more drag and limits the rocket's range.

With the start of modern rocketry in the 20th century, new ways were sought to improve rocket stability and at the same time reduce overall rocket

weight. The answer to this was the development of active controls. Active control systems included *vanes*, *movable fins*, *canards*, *gimbaled nozzles*, *vernier rockets*, *fuel injection*, and *attitude-control rockets*. Tilting fins and canards are quite similar to each other in appearance. The only real difference between them is their location on the rockets. Canards are mounted on the front end of the rocket while the tilting fins are at the rear. In flight, the fins and canards tilt like rudders to deflect the air flow and cause the rocket to change course. Motion sensors on the rocket detect unplanned directional changes, and corrections can be made by slight tilting of the fins and canards. The advantage of these two devices is size and weight. They are smaller and lighter and produce less drag than the large fins.

Other active control systems can eliminate fins and canards altogether. By tilting the angle at which the exhaust gas leaves the rocket engine, course changes can be made in flight. Several techniques can be used for changing exhaust direction.

Vanes are small finlike devices that are placed inside the exhaust of the rocket engine. Tilting the vanes deflects the exhaust, and by action-reaction the rocket responds by pointing the opposite way.

Another method for changing the exhaust direction is to gimbal the nozzle. A gimbaled nozzle is one that is able to sway while exhaust gases are passing through it. By tilting the engine nozzle in the proper direction, the rocket responds by changing course.

Vernier rockets can also be used to change direction. These are small rockets mounted on the outside of the large engine. When needed they fire, producing the desired course change.

In space, only by spinning the rocket along the roll axis or by using active controls involving the engine exhaust can the rocket be stabilized or have its direction changed. Without air, fins and canards have nothing to work upon. (Science fiction movies showing rockets in space with wings and fins are long on fiction and short on science.) While coasting in space, the most common kinds of active control used are attitude-control rockets. Small clusters of engines are mounted all around the vehicle. By firing the right combination of these small rockets, the vehicle can be turned in any direction. As soon as they are aimed properly, the main engines fire, sending the rocket off in the new direction.

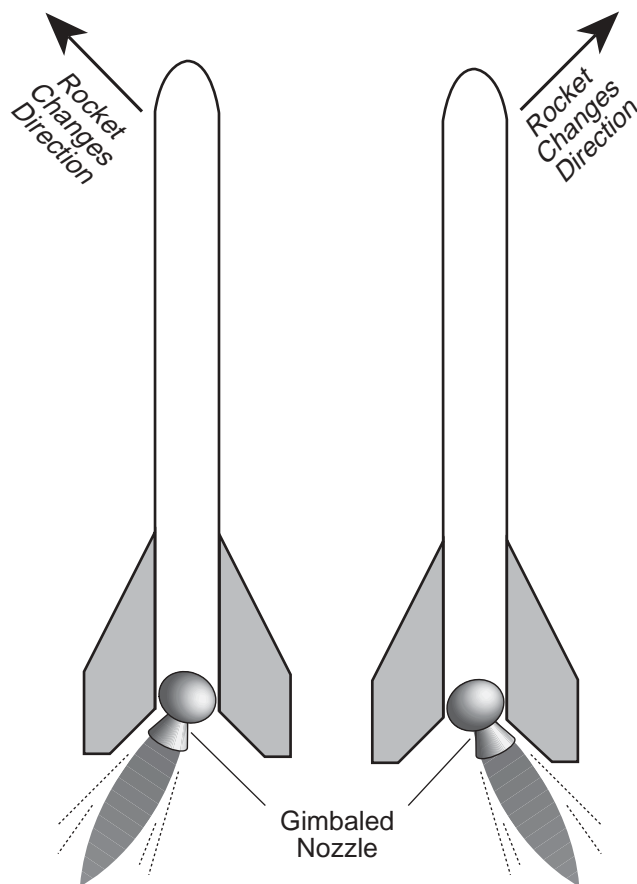

Mass

Mass is another important factor affecting the performance of a rocket. The mass of a rocket can make the difference between a successful flight and just wallowing around on the launch pad. As a basic principle of rocket flight, it can be said that for a rocket to leave the ground, the engine must produce a thrust that is greater than the total mass of the vehicle. It is obvious that a rocket with a lot of unnecessary mass will not be as efficient as one that is trimmed to just the bare essentials.

For an ideal rocket, the total mass of the vehicle should be distributed following this general formula:

Of the total mass, 91 percent should be propellants; 3 percent should be tanks, engines, fins, etc.; and 6 percent can be the payload.

Payloads may be satellites, astronauts, or spacecraft that will travel to other planets or moons.

In determining the effectiveness of a rocket design, rocketeers speak in terms of mass fraction (MF). The mass of the propellants of the rocket divided by the total mass of the rocket gives mass fraction:

$$MF = \frac{\text{mass of propellants}}{\text{total mass}}$$

The mass fraction of the ideal rocket given above is 0.91. From the mass fraction formula one might think that an MF of 1.0 is perfect, but then the entire rocket would be nothing more than a lump of propellants that would simply ignite into a fireball. The larger the MF number, the less payload the rocket can carry; the smaller the MF number, the less its range becomes. An MF number of 0.91 is a good balance between payload-carrying capability and range. The Space Shuttle has an MF of approximately 0.82. The MF varies between the different orbiters in the Space Shuttle fleet and with the different payload weights of each mission.

Large rockets, able to carry a spacecraft into space, have serious weight problems. To reach space and proper orbital velocities, a great deal of propellant is needed; therefore, the tanks, engines, and associated hardware become larger. Up to a point, bigger rockets can carry more payload than smaller rockets, but when they become too large their structures weigh them down too much, and the mass fraction is reduced to an impossible number.

A solution to the problem of giant rockets weighing too much can be credited to the 16th-century fireworks maker Johann Schmidlap. Schmidlap attached small rockets to the top of big ones. When the large rocket was exhausted, the rocket casing was dropped behind and the remaining rocket fired. Much higher altitudes were achieved by this method. (The Space Shuttle follows the step rocket principle by dropping off its solid rocket boosters and external tank when they are exhausted of propellants.)

The rockets used by Schmidlap were called step rockets. Today this technique of building a rocket is called *staging*. Thanks to staging, it has become possible not only to reach outer space but the Moon and other planets too.

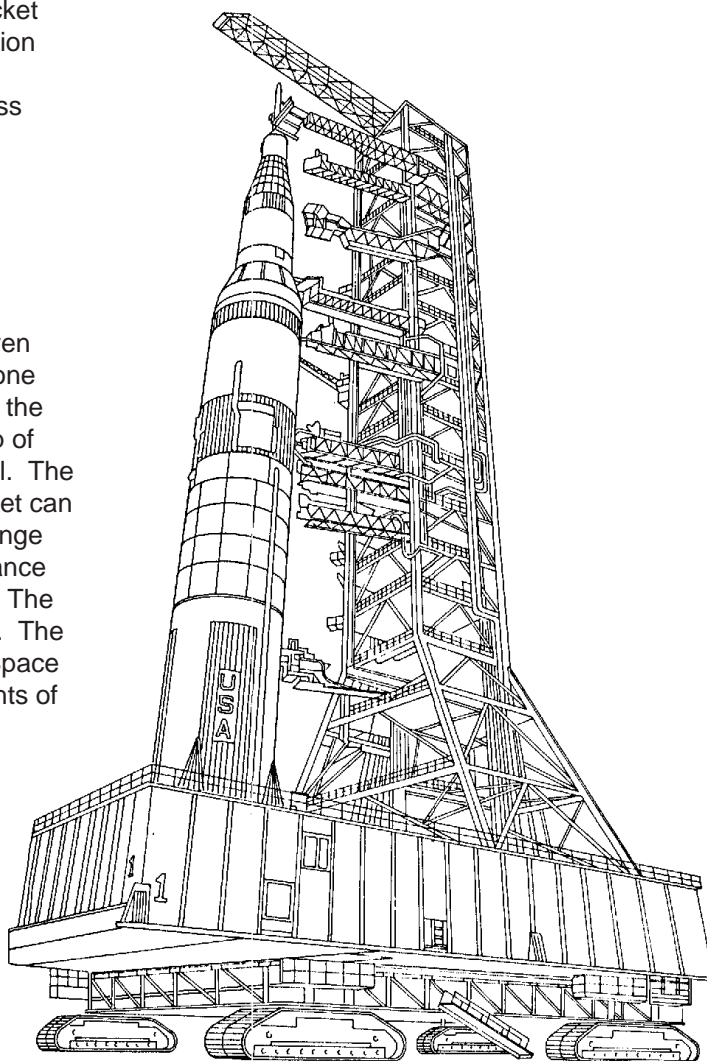

Saturn 5 rocket being transported to the launch pad.

Launch Vehicle Family Album

The pictures on the next several pages serve as a partial "family album" of NASA launch vehicles. NASA did not develop all of the vehicles shown, but has employed each in its goal of "exploring the atmosphere and space for peaceful purposes for the benefit of all." The album contains historic rockets, those in use today, and concept designs that might be used in the future. They are arranged in three groups: rockets for launching satellites and space probes, rockets for launching humans into space, and concepts for future vehicles.

The album tells the story of nearly 40 years of NASA space transportation. Rockets have probed the upper reaches of Earth's atmosphere, carried spacecraft into Earth orbit, and sent spacecraft out into the solar system and beyond. Initial rockets employed by NASA, such as the Redstone and the Atlas, began life as intercontinental ballistic missiles. NASA scientists and engineers found them ideal for carrying machine and human payloads into space. As the need for greater payload capacity increased, NASA began altering designs for its own rockets and building upper stages to use with existing rockets. Sending astronauts to the Moon required a bigger rocket than the rocket needed for carrying a small satellite to Earth orbit.

Today, NASA's only vehicle for lifting astronauts into space is the Space Shuttle. Designed to be reusable, its solid rocket boosters have parachute recovery systems. The orbiter is a winged spacecraft that glides back to Earth. The external tank is the only part of the vehicle which has to be replaced for each mission.

Launch vehicles for the future will continue to build on the experiences of the past. Vehicles will become more versatile and less expensive to operate as new technologies become available.



Rocket Timeline

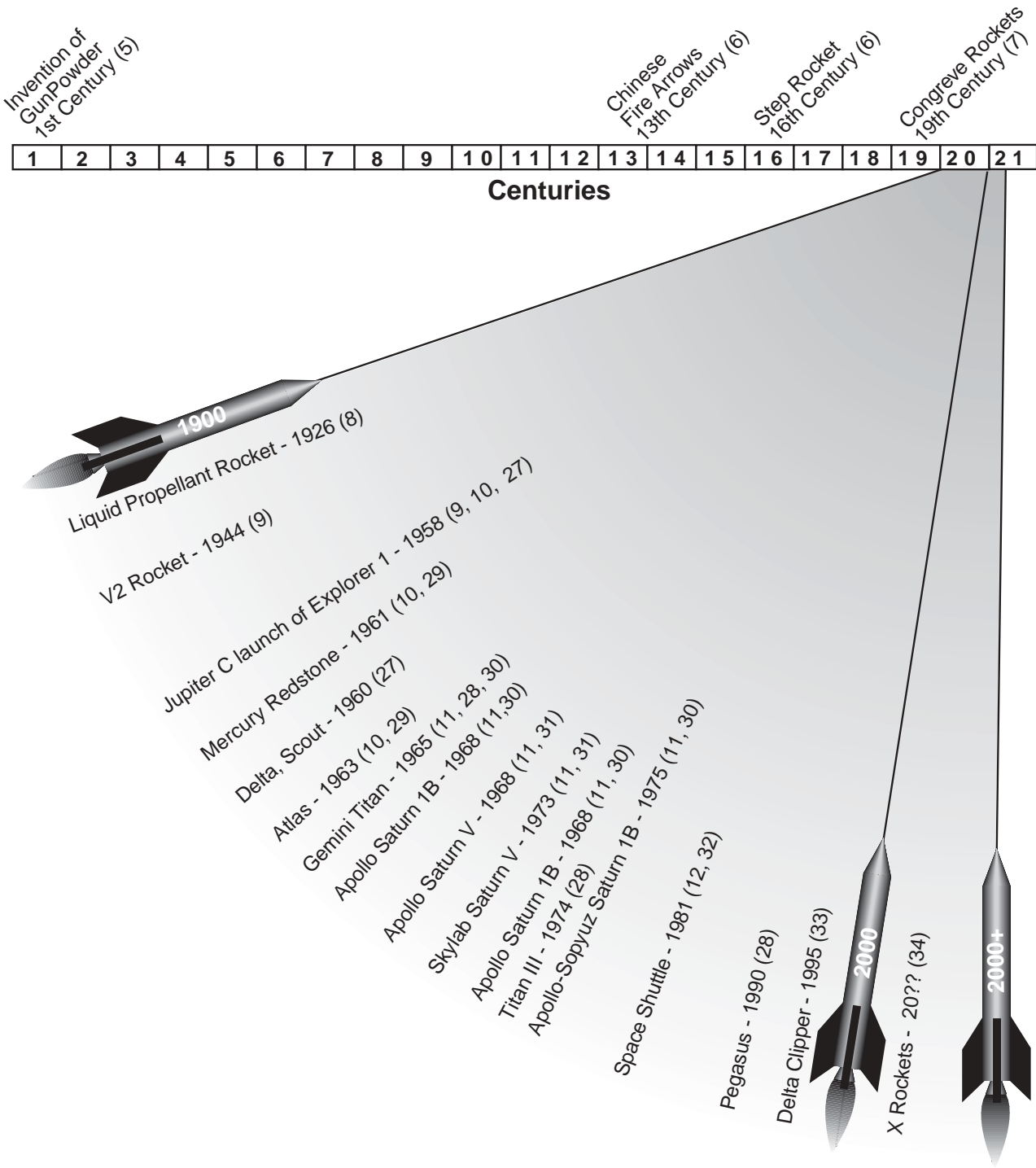

Most significant rocket developments have taken place in the twentieth century. After 1958, all entries in this timeline relate to NASA space missions. Provided here are the years in which new rocket systems were first flown. Additional information about these events can be found in this guide on the pages indicated by parentheses.



Rockets for Launching Satellites and Space Probes



The Jupiter-C rocket that carried Explorer I sits on the launch pad venting before launch, January 31, 1958.



NASA's Scout rocket is a four-stage solid rocket booster that can launch small satellites into Earth orbit. The Scout can carry about a 140 kilogram payload to a 185 kilometer high orbit. NASA used the Scout for more than 30 years. This 1965 launch carried the *Explorer 27* scientific satellite.



One of NASA's most successful rockets is the Delta. The Delta can be configured in a variety of ways to change its performance to meet needs of the mission. It is capable of carrying over 5,000 kilograms to a 185 kilometer high orbit or 1,180 kilograms to a geosynchronous orbit with an attached booster stage. This Delta lifted the *Galaxy-C* communication satellite to space on September 21, 1984.





A Titan III Centaur rocket carried *Voyager 1*, the first interplanetary spacecraft to fly by both Jupiter and Saturn, into space on September 5, 1975. The Titan, a U.S. Air Force missile, combined with NASA's Centaur upper stage and two additional side-mounted boosters, provided the needed thrust to launch *Voyager*.

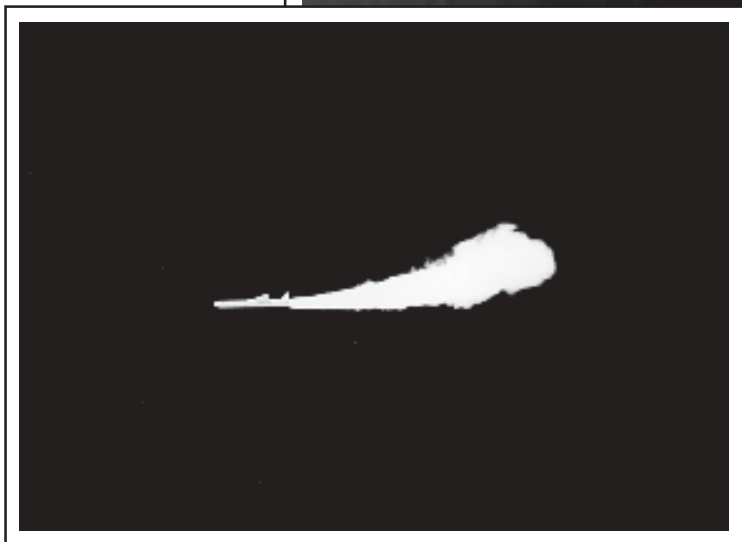
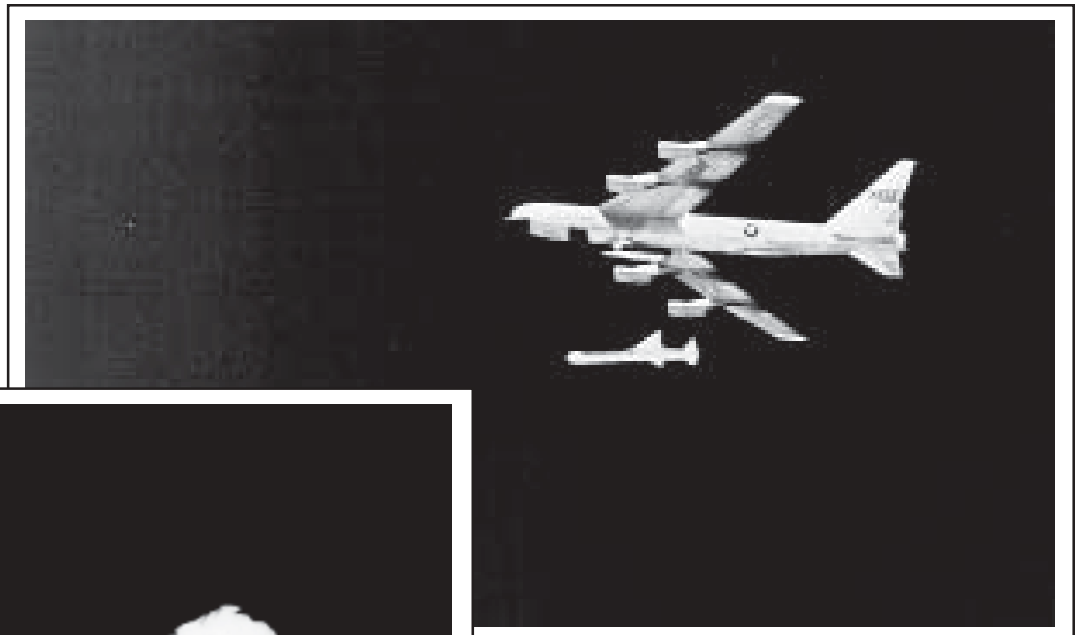

The Pegasus air-launched space booster roars toward orbit following its release from a NASA *B-52* aircraft. The booster, built by Orbital Sciences Corporation and Hercules Aerospace Company, is a low-cost way of carrying small satellites to Earth orbit. This launch took place on April 5, 1990.



Rockets for Sending Astronauts Into Space



Allan Shepard became the first American astronaut to ride to space on May 5, 1961. Shepard rode inside a *Mercury* space capsule on top of a Redstone rocket.

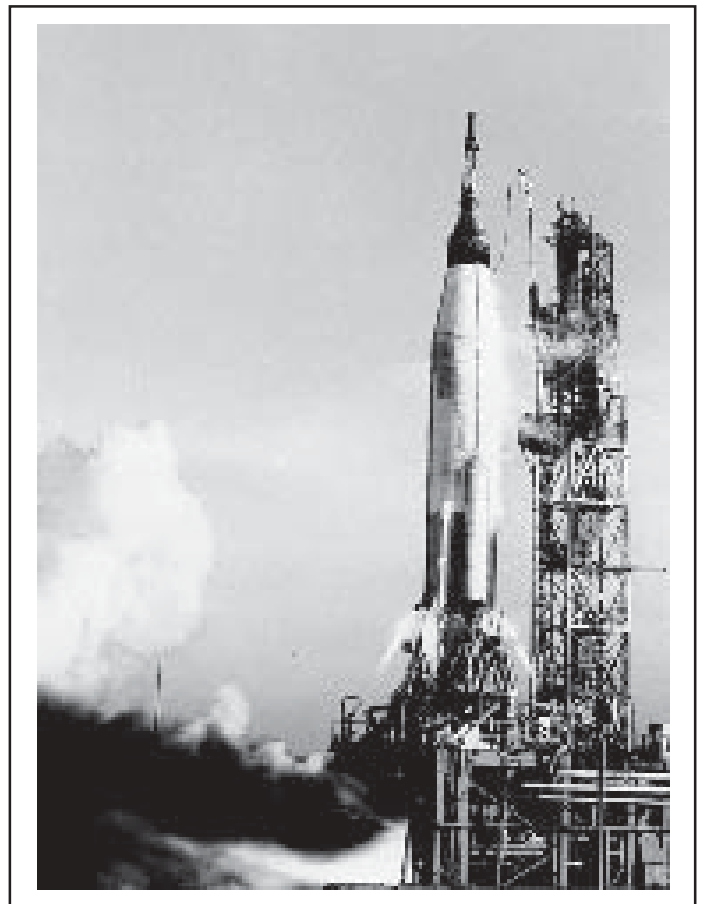

An Atlas launch vehicle, with a *Mercury* space capsule at the top, underwent a static firing test to verify engine systems before its actual launch. The *Mercury/Atlas* combination launched four *Mercury* orbital missions including the historic first American orbital flight of John Glenn.



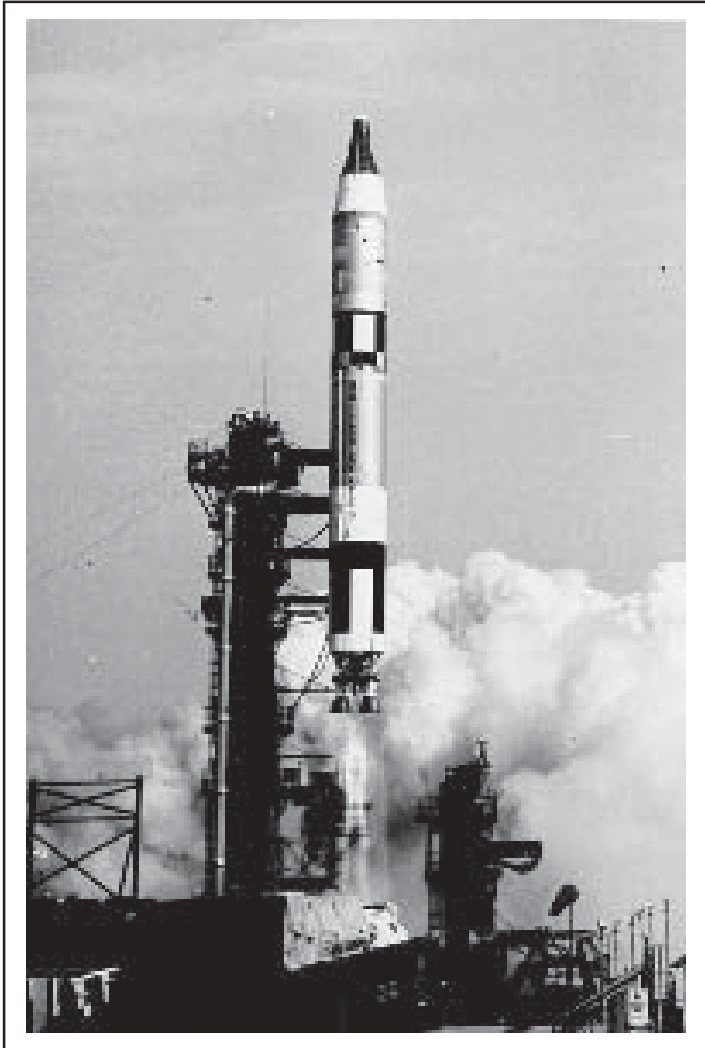

Virgil I. Grissom and John W. Young rode to orbit inside a *Gemini* spacecraft mounted at the top of this Titan rocket. The spacecraft reached an orbit ranging from 161 to 225 kilometers on March 23, 1965.



Used to lift *Apollo* spacecraft to Earth orbit, the nearly 70-meter-tall Saturn 1B rocket carries the *Apollo 7* crew on October 11, 1968. Saturn 1B rockets also transported crews for *Skylab* (1973-74) and *Apollo/Soyuz* missions (1975).

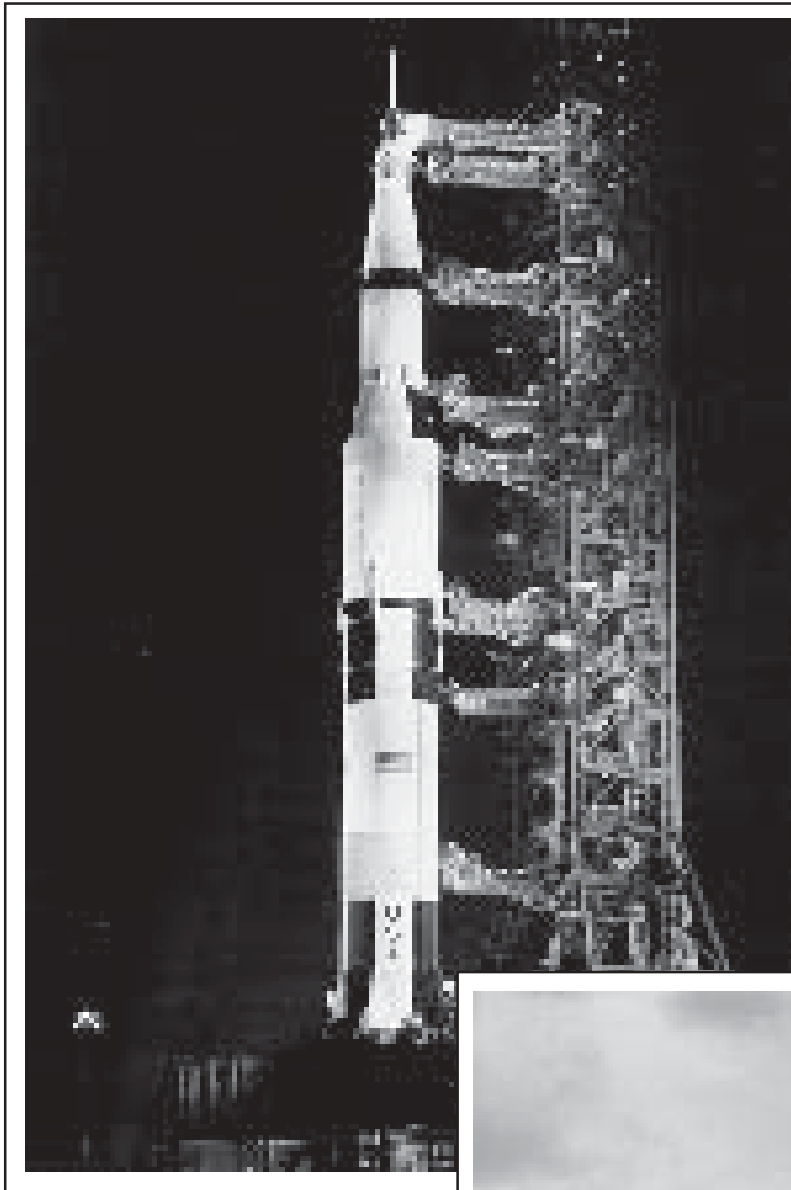

The 111-meter-high Saturn 5 rocket carried the *Apollo 11* crew to the Moon.

Using a modified Saturn 5 rocket, NASA sent the 90,600 kilogram *Skylab* Space Station to orbit on May 14, 1973. The space station replaced the Saturn 5's third stage.

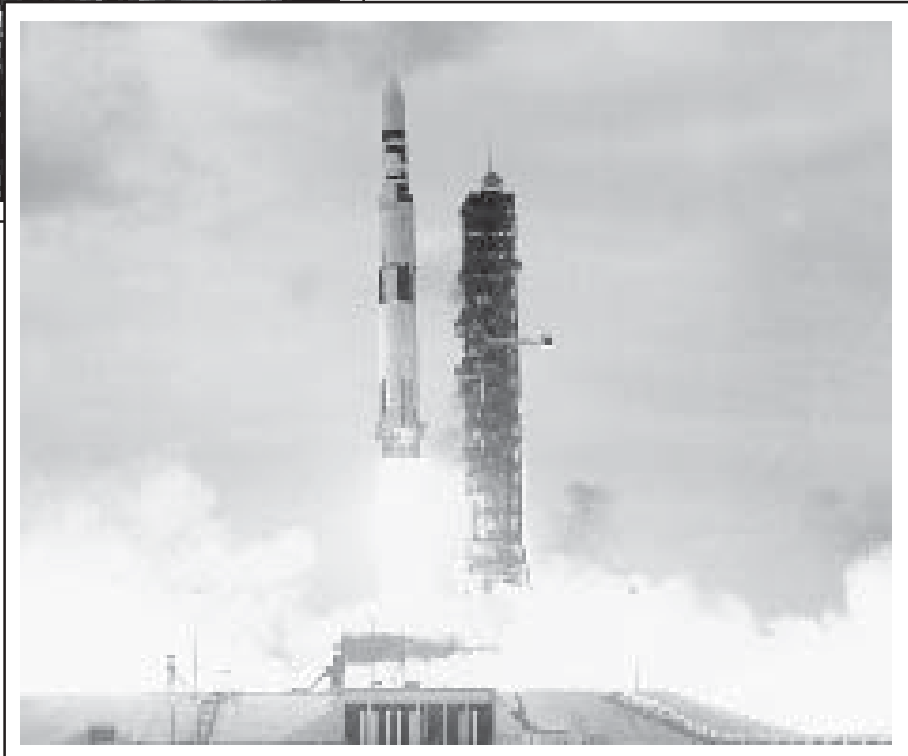



Today, NASA Astronauts launch into space onboard the Space Shuttle. The Shuttle consists of a winged orbiter that climbs into space as a rocket, orbits Earth as a satellite, and lands on a runway as an airplane. Two recoverable solid rocket boosters provide additional thrust and an expendable external tank carries the propellants for the orbiter's main engines. This was the launch of STS-53 on December 2, 1992.

Concepts for Future Vehicles

The launch vehicles on this and the next page are ideas for future reusable launch vehicles. Most are variations of the winged Space Shuttle orbiter.



The Delta Clipper Experimental (DC-X) vehicle, originally developed for the Department of Defense, lifts off at the White Sands Missile Range in New Mexico. NASA has assumed the role of managing the vehicle's further development. The DC-X lifts off and lands vertically. NASA hopes this vehicle could lead to a low-cost payload launching system. The Delta Clipper was recently renamed the "Clipper Graham" in honor of the late space pioneer Lt. General Daniel O. Graham.



The X-34 is a reusable booster concept that could lead to larger vehicles in the future. This rocket would launch from a carrier aircraft to deliver a payload to orbit.



NASA has chosen this concept to replace the Space Shuttle fleet in the 21st century. The X-33 will be a single-stage-to-orbit vehicle in which the entire vehicle lifts off into space and returns to Earth intact.



Looking like a Space Shuttle orbiter, this new launcher concept is also a single-stage-to-orbit vehicle.

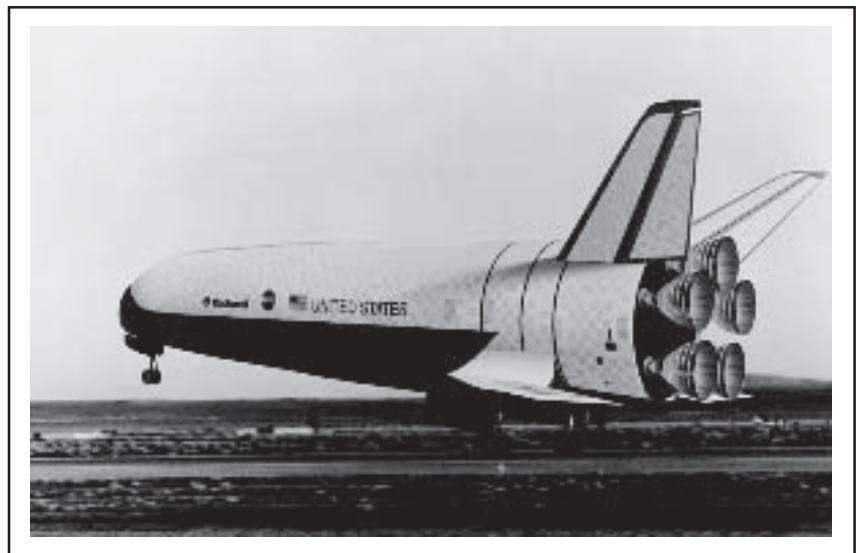

Activities

Activity Matrix	36
Pop Can Hero Engine	39
Rocket Car	45
3-2-1 Pop!	53
Antacid Tablet Race	57
Paper Rockets.....	61
Newton Car	67
Balloon Staging	73
Rocket Transportation	76
Altitude Tracking	79
Bottle Rocket Launcher	87
Bottle Rocket	91
Project X-35	95



Activity Matrix

Standards and Skills

Science as Inquiry
 Physical Science
 - Position & Motion of Objects
 - Properties of Objects and Materials
 Unifying Concepts and Processes
 - Change, Constancy, & Measurement
 Evidence, Models, & Explanation
 Science and Technology
 - Abilities of Technology
 - Understanding about Science & Technology
 Science in Personal & Social Perspectives
 - Science and Technology in Local Challenges

Science Standards

Pop Can Hero Engine	▲	▲	▲		▲	▲		▲		▲		
Rocket Racer	▲	▲	▲		▲	▲		▲	▲			
3-2-1 Pop!		▲	▲					▲	▲	▲		
Antacid Tablet Race	▲	▲		▲				▲	▲			
Paper Rockets	▲	▲	▲		▲	▲	▲	▲	▲			
Newton Car	▲	▲		▲	▲	▲	▲					
Balloon Staging		▲	▲					▲	▲	▲		
Rocket Transportation	▲	▲	▲					▲	▲			
Altitude Tracking		▲	▲					▲	▲	▲		
Bottle Rocket Launcher		▲	▲					▲	▲			
Bottle Rocket		▲	▲					▲	▲			
Project X-35	▲	▲	▲					▲	▲		▲	▲

Observing
 Communicating
 Measuring
 Collecting Data
 Inferring
 Predicting
 Making Models
 Making Graphs
 Hypothesizing
 Interpreting Data
 Controlling Variables
 Defining Operationally
 Investigating

Science Process Skills

Pop Can Hero Engine	▲	▲	▲	▲	▲	▲	▲	▲	▲	▲	▲	▲
Rocket Racer	▲	▲	▲	▲	▲		▲	▲		▲	▲	▲
3-2-1 Pop!	▲	▲			▲		▲					
Antacid Tablet Race	▲	▲	▲	▲	▲	▲		▲	▲	▲	▲	▲
Paper Rockets	▲	▲	▲	▲	▲	▲	▲			▲	▲	▲
Newton Car	▲	▲	▲	▲	▲	▲		▲		▲	▲	▲
Balloon Staging	▲						▲				▲	
Rocket Transportation	▲	▲	▲	▲	▲	▲	▲			▲	▲	▲
Altitude Tracking	▲		▲	▲						▲		
Bottle Rocket Launcher			▲									
Bottle Rocket			▲				▲					
Project X-35	▲	▲	▲	▲	▲	▲	▲			▲	▲	▲



Mathematics Standards

	Problem Solving	Communication	Reasoning	Connections	Number & Number Relationships	Computation & Estimation	Patterns & Functions	Statistics	Probability	Geometry	Measurement	Functions	Trigonometry
Pop Can Hero Engine					▲	▲	▲			▲			
Rocket Racer	▲	▲	▲	▲	▲	▲	▲	▲		▲			
3-2-1 Pop!													
Antacid Tablet Race		▲		▲	▲	▲	▲			▲			
Paper Rockets	▲		▲	▲		▲	▲	▲					
Newton Car	▲	▲		▲		▲	▲	▲		▲			
Balloon Staging													
Rocket Transportation	▲	▲	▲	▲	▲					▲			
Altitude Tracking		▲	▲	▲	▲	▲			▲	▲		▲	
Bottle Rocket Launcher				▲						▲			
Bottle Rocket				▲					▲	▲			
Project X-35	▲	▲	▲		▲	▲			▲	▲		▲	





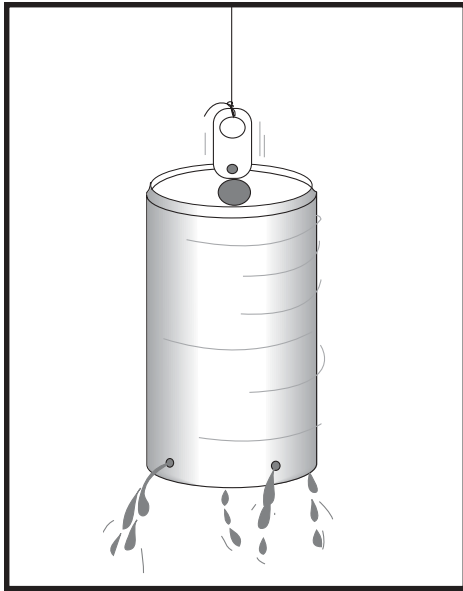

Educator Information

Pop Can Hero Engine

Objectives:

- To demonstrate Newton's Third Law of Motion by using the force of falling water to cause a soda pop can to spin.
- To experiment with different ways of increasing the spin of the can.

Description:

A soft drink can suspended by a string spins by the force created when water streams out of slanted holes near the can's bottom.

Science Standards:

Science as Inquiry
Physical Science - Position and motion of objects
Unifying Concepts and Processes - Change, constancy, and measurement
Science and Technology - Understanding about science and technology

Science Process Skills:

Observing
Communicating
Measuring
Collecting Data
Inferring
Predicting
Making Models
Interpreting Data
Making Graphs
Hypothesizing
Controlling Variables
Defining Operationally
Investigating

Mathematics Standards:

Computation and Estimation
Whole Number Computation
Measurement
Statistics
Probability

Management:

This activity works well with small groups of two or three students. Allow approximately 40 to 45 minutes to complete. The activity is divided into two parts. In part one

Part One

Materials and Tools:

- Empty soda pop can with the opener lever still attached - one per group of students
- Common nail - one per group of students
- Nylon fishing line (light weight)
- Bucket or tub of water - several for entire class
- Paper towels for cleanup
- Meter stick
- Scissors to cut fishing line

the learners construct the engine and test it. Part two focuses on variables that affect the action of the engine. The experiment stresses prediction, data collection, and analysis of results. ★Be sure to recycle the soda pop cans at the end of the activity.

Background Information:

Hero of Alexandria invented the Hero engine in the first century B.C. His engine operated because of the propulsive force generated by escaping steam. A boiler produced steam that escaped to the outside through L-shaped tubes bent pinwheel fashion. The steam's escape produced an action-reaction force that caused the sphere to spin in the opposite direction. Hero's engine is an excellent demonstration of Newton's Third Law of



Motion (See page 5 for more information about Hero's Engine and pages 15-16 for details about Newton's Third Law of Motion.). This activity substitutes the action force produced by falling water for the steam in Hero's Engine.

**Part One:
Making a Soda Pop Can Hero Engine:**

1. Distribute student pages and one soda pop can and one medium-size common nail to each group. Tell the students that you will demonstrate the procedure for making the Hero engine.
2. Lay the can on its side and use the nail to punch a single hole near its bottom. Before removing the nail, push the nail to one side to bend the metal, making the hole slant in that direction.
3. Remove the nail and rotate the can approximately 90 degrees. Make a second hole like the first one. Repeat this procedure two more times to produce four equally spaced holes around the bottom of the can. All four holes should slant in the same direction going around the can.
4. Bend the can's opener lever straight up and tie a 40-50 centimeter length of fishing line to it. The soda pop can Hero engine is complete.

Running the Engine:

1. Dip the can in the water tub until it fills with water. Ask the students to predict what will happen when you pull the can out by the fishing line.
2. Have each group try out their Hero engine.

Discussion:

1. Why did the cans begin spinning when water poured out of the holes?
2. What was the action? What was the reaction?
3. Did all cans spin equally well? Why or why not?

How To Bend The Holes

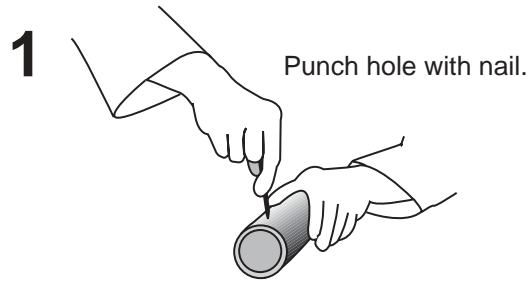

**Part Two:
Experimenting with Soda Pop Can Hero Engines**

1. Tell the students they are going to do an experiment to find out if there is any relationship between the size of the holes punched in the Hero Engine and how

**Part Two
Materials and Tools:**

- Student Work Sheets
- Hero Engines from part one
- Empty soda pop can with the opener lever still attached (three per group of students)
- Common nails - Two different diameter shafts (one each per group)
- Nylon fishing line (light weight)
- Bucket or tub of water - Several for entire class
- Paper towels for cleanup
- Meter stick
- Large round colored gum labels or marker pens
- Scissors to cut fishing line

many times it rotates. Ask students to predict what they think might happen to the rotation of the Hero engine if they punched larger or smaller holes in the cans. Discuss possible hypotheses for the experiment.



2. Provide each group with the materials listed for Part Two. The nails should have different diameter shafts from the one used to make the first engine. Identify these nails as small (S) and large (L). Older students can measure the diameters of the holes in millimeters. Since there will be individual variations, record the average hole diameter. Have the groups make two additional engines exactly like the first, except that the holes will be different sizes.
3. Discuss how to count the times the engines rotate. To aid in counting the number of rotations, stick a brightly-colored round gum label or some other marker on the can. Tell them to practice counting the rotations of the cans several times to become consistent in their measurements before running the actual experiment.
4. Have the students write their answers for each of three tests they will conduct on the can diagrams on the Student Pages. (Test One employs the can created in Part One.) Students should not predict results for the second and third cans until they have finished the previous tests.
5. Discuss the results of each group's experiment. Did the results confirm the experiment hypothesis?
6. Ask the students to propose other ways of changing the can's rotation (Make holes at different distances above the bottom of the can, slant holes in different directions or not slanted at all, etc.) Be sure they compare the fourth Hero Engine they make with the engine previously made that has the same size holes.

Discussion:

1. Compare the way rockets in space change the directions they are facing in space with the way Hero Engines work.
2. How can you get a Hero Engine to turn in the opposite direction?
3. Can you think of any way to put Hero Engines to practical use?

4. In what ways are Hero Engines similar to rockets? In what ways are they different?

Assessment:

Conduct a class discussion where students share their findings about Newton's Laws of Motion. Collect and review completed Student Pages.

Extensions:

- Compare a rotary lawn sprinkler to Hero's Engine.
- Research Hero and his engine. Was the engine put to any use?
- Build a steam-powered Hero engine - See instructions below.

Steam-Powered Hero Engine

A steam powered Hero engine can be manufactured from a copper toilet tank float and some copper tubing. Because this version of the Hero engine involves steam, it is best to use it as a demonstration only.

Teacher Model

Materials and Tools:

- Copper toilet tank float (available from some hardware or plumbing supply stores)
- Thumb screw, 1/4 inch
- Brass tube, 3/16 I.D., 12 in. (from hobby shops)
- Solder
- Fishing line
- Ice pick or drill
- Metal file
- Propane torch

1. File the middle of the brass tube to produce a notch. Do not file the tube in half.

File notch in middle of tube. (Step 1.)

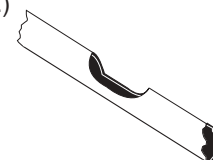

2. Using the ice pick or drill, bore two small holes on opposite sides of the float at its middle. The holes should be just large enough to pass the tube straight through the float.
3. With the tube positioned so that equal lengths protrude through the float, heat the contact points of the float and tube with the propane torch. Touch the end of the solder to the heated area so that it melts and seals both joints.
4. Drill a water access hole through the threaded connector at the top of the float.
5. Using the torch again, heat the protruding tubes about three centimeters from each end. With pliers, carefully bend the tube tips in opposite directions. Bend the tubes slowly so they do not crimp.
6. Drill a small hole through the flat part of the thumb screw for attaching the fish line and swivel. Twist the thumb screw into the threaded connector of the float in step 4 and attach the line and swivel.

Procedure:

Using the Steam-Powered Hero Engine

1. Place a small amount of water (about 10 to 20 ml) into the float. The precise amount is not important. The float can be filled through the top if you drilled an access hole or through the tubes by partially immersing the engine in a bowl of water with one tube submerged and the other out of the water.
2. Suspend the engine and heat its bottom with the torch. In a minute or two, the engine should begin spinning. ★Be careful not to operate the engine too long because it may not be balanced well and could wobble violently. If it begins to wobble, remove the heat.

Caution: Wear eye protection when demonstrating the engine. Be sure to confirm that the tubes are not obstructed in any way before heating. Test them by blowing through one like a straw. If air flows out the other tube, the engine is safe to use.

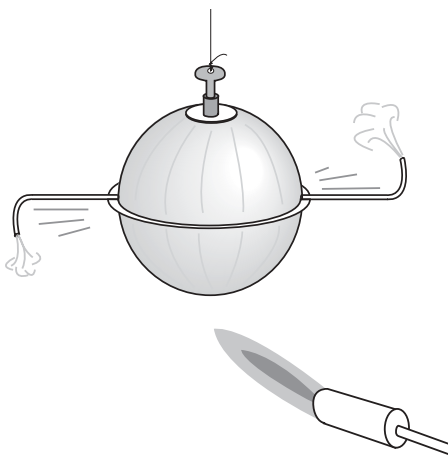

Finished Steam-Powered Hero Engine



Pop Can Hero Engine

Names of Team Members:

Design an experiment that will test the effect that the size of the holes has on the number of spins the can makes. What is your experiment hypothesis?

Mark each can to help you count the spins.

Test each Hero Engine and record your data on the cans below.

Test Number 1

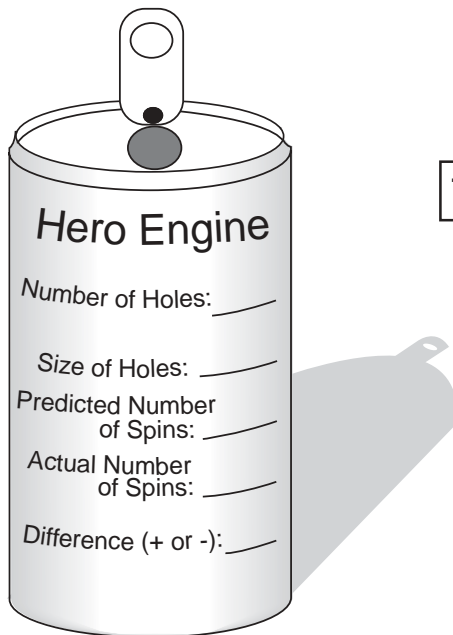

Test Number 2

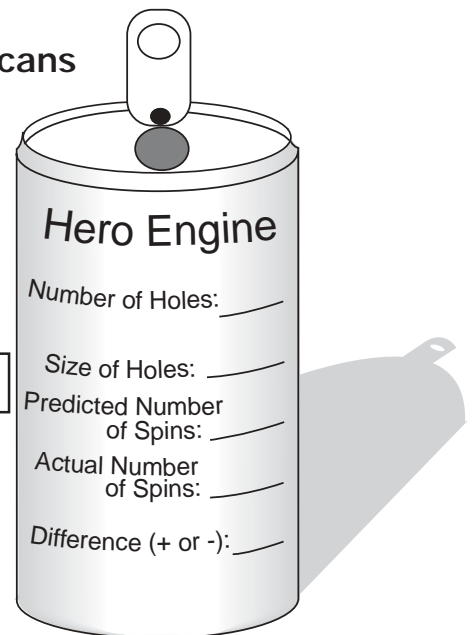

Test Number 3

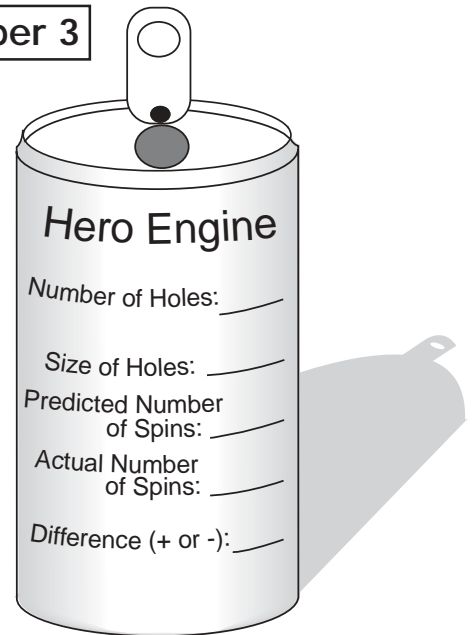

Based on your results, was your hypothesis correct?

Why?



Design a new Hero Engine experiment. Remember, change only one variable in your experiment.

What is your experiment hypothesis? _____

Compare this engine with the engine from your first experiment that has the same size holes.

Based on your results, was your hypothesis correct? _____

Why? _____

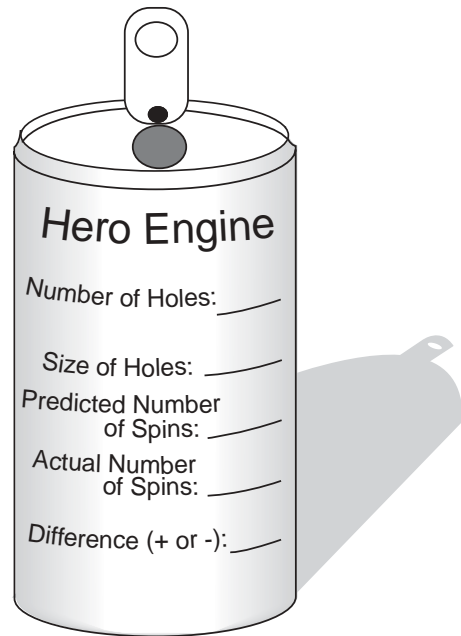

Describe what you learned about Newton's Laws of Motion by building and testing your Hero Engines.

Share your findings with other members of your class.



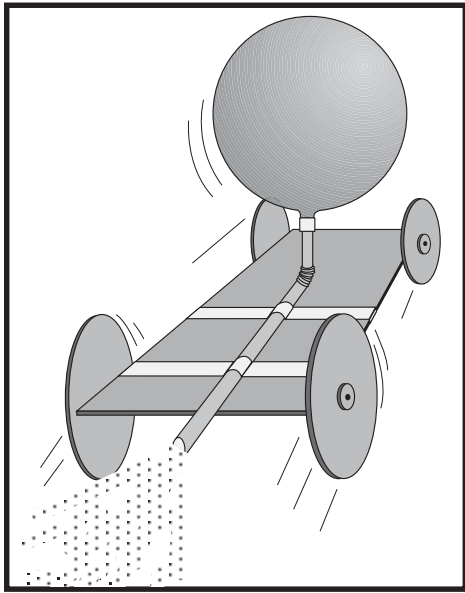

Educator Information

Rocket Racer

Objectives:

- To construct a rocket propelled vehicle.
- To experiment with ways of increasing the distance the rocket racer travels.

Description:

Students construct a balloon-powered rocket racer from a styrofoam tray, pins, tape, and a flexible straw, and test it along a measured track on the floor.

Science Standards:

Science as Inquiry
Physical Science - Position and motion of objects
Science and Technology - Abilities of technological design
Unifying Concepts and Processes - Change, constancy, and measurement

Science Process Skills:

Observing
Communicating
Measuring
Collecting Data
Inferring
Making Models
Interpreting Data
Making Graphs
Controlling Variables
Defining Operationally
Investigating

Mathematics Standards:

Mathematics as Problem Solving
Mathematics as Communication
Mathematics as Reasoning
Mathematical Connections
Measurement
Statistics and Probability
Patterns and Relationships

Management:

This activity can be done individually or with students working in pairs. Allow 40 to 45 minutes to complete the first part of the activity. The activity stresses

Materials and Tools:

- 4 Pins
- Styrofoam meat tray
- Masking tape
- Flexible straw
- Scissors
- Drawing compass
- Marker pen
- Small round party balloon
- Ruler
- Student Sheets (one set per group)
- 10 Meter tape measure or other measuring markers for track (one for the whole class)

technology education and provides students with the opportunity to modify their racer designs to increase performance. The optional second part of the activity directs students to design, construct, and test a new rocket racer based on the results of the first racer. Refer to the materials list and provide what is needed for making one rocket racer for each group of two students. Styrofoam food trays are available from butchers in supermarkets. They are usually sold for a few cents each or you may be able to get them donated. Students can also save trays at home and bring them to class.



If compasses are not available, students can trace circular objects to make the wheels or use the wheel and hubcap patterns printed on page 48. Putting hubcaps on both sides of the wheels may improve performance.

If using the second part of the activity, provide each group with an extra set of materials. Save scraps from the first styrofoam tray to build the second racer. You may wish to hold drag or distance races with the racers. The racers will work very well on tile floors and carpeted floors with a short nap. Several tables stretched end to end will also work, but racers may roll off the edges.

Although this activity provides one rocket racer design, students can try any racer shape and any number, size, and placement of wheels they wish. Long racers often work differently than short racers.

Background Information:

The Rocket Racer is a simple way to observe Newton's Third Law of Motion. (Please refer to pages 15-16 of the rocket principles section of this guide for a complete description.)

While it is possible to demonstrate Newton's Law with just a balloon, constructing a rocket racer provides students with the opportunity to put the action/reaction force to practical use. In this case, the payload of the balloon rocket is the racer. Wheels reduce friction with the floor to help racers move. Because of individual variations in the student racers, they will travel different distances and often in unplanned directions. Through modifications, the students can correct for undesirable results and improve their racers' efficiency.

Making a Rocket Racer:

1. Distribute the materials and construction tools to each student group. If you are going to have them construct a second racer, tell them to save styrofoam tray scraps for later. Hold back the additional

materials for the second racer until students need them.

2. Students should plan the arrangement of parts on the tray before cutting them out. If you do not wish to use scissors, students can trace the pattern pieces with the sharp point of a pencil or a pen. The pieces will snap out of the styrofoam if the lines are pressed deeply.
3. Lay out a track on the floor approximately 10 meters long. Several metric tape measures joined together can be placed on the floor for determining how far the racers travel. The students should measure in 10 centimeter intervals.
4. Test racers as they are completed. Students should fill in the data sheets and create a report cover with a drawing of the racer they constructed.
5. If a second racer will be constructed, distribute design pages so that the students can design their racers before starting construction.

Extensions:

- Hold Rocket Racer races.
- Tie a loop of string around the inflated balloon before releasing the racer. Inflate the balloon inside the string loop each time you test the racers. This will increase the accuracy of the tests by insuring the balloon inflates the same amount each time.
- Make a balloon-powered pinwheel by taping another balloon to a flexible straw. Push a pin through the straw and into the eraser of a pencil. Inflate the balloon and watch it go.

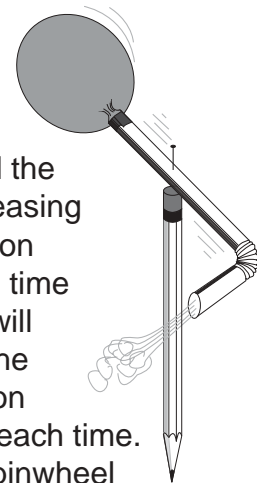

Assessment:

Students will create "Rocket Racer Test Reports" to describe test runs and modifications that improved their racer's efficiency. Use these reports for assessment along with the design sheet and new racer, should you choose to use the second part of this activity.



How To Build A Rocket Racer

1. Lay out your pattern on a styrofoam tray. You need 1 car body, 4 wheels, and 4 hubcaps. Use a compass to draw the wheels.

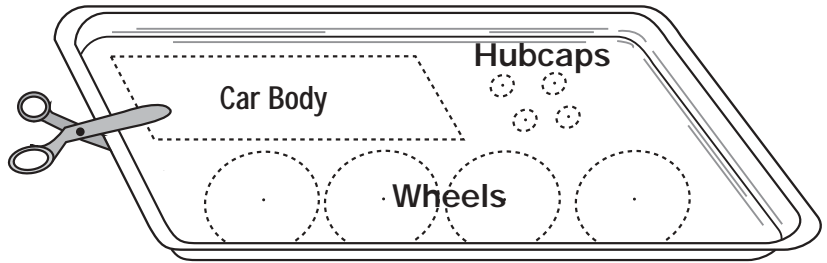

2. Blow up the balloon and let the air out. Tape the balloon to the short end of a flexible straw and then tape the straw to the rectangle.

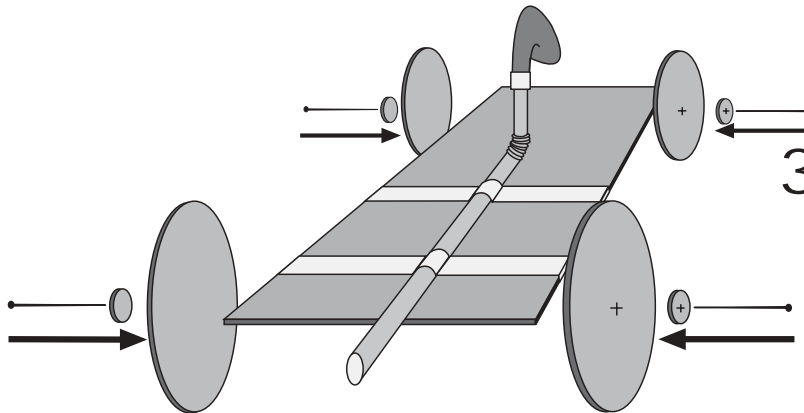
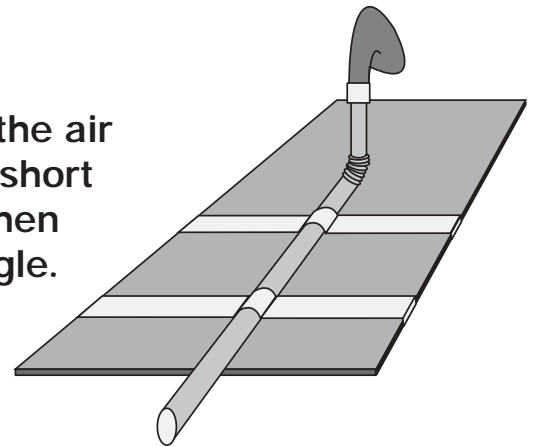

3. Push pins through the hubcaps into the wheels and then into the edges of the rectangle.

4. Blow up the balloon through the straw. Squeeze the end of the straw. Place the racer on floor and let it go!

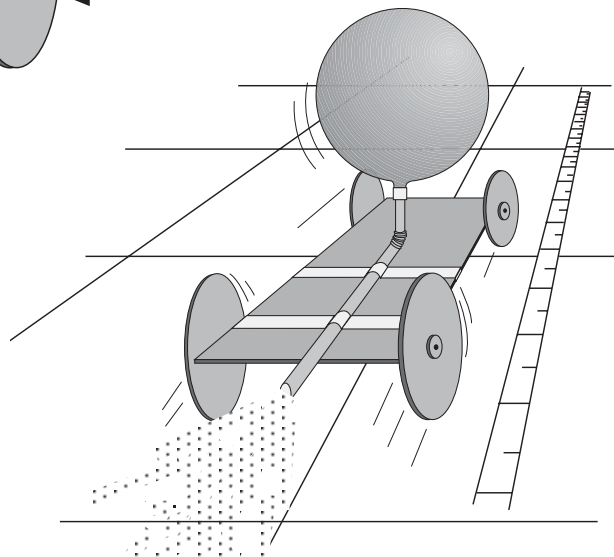

Wheel Patterns

(Crosses mark the centers.)

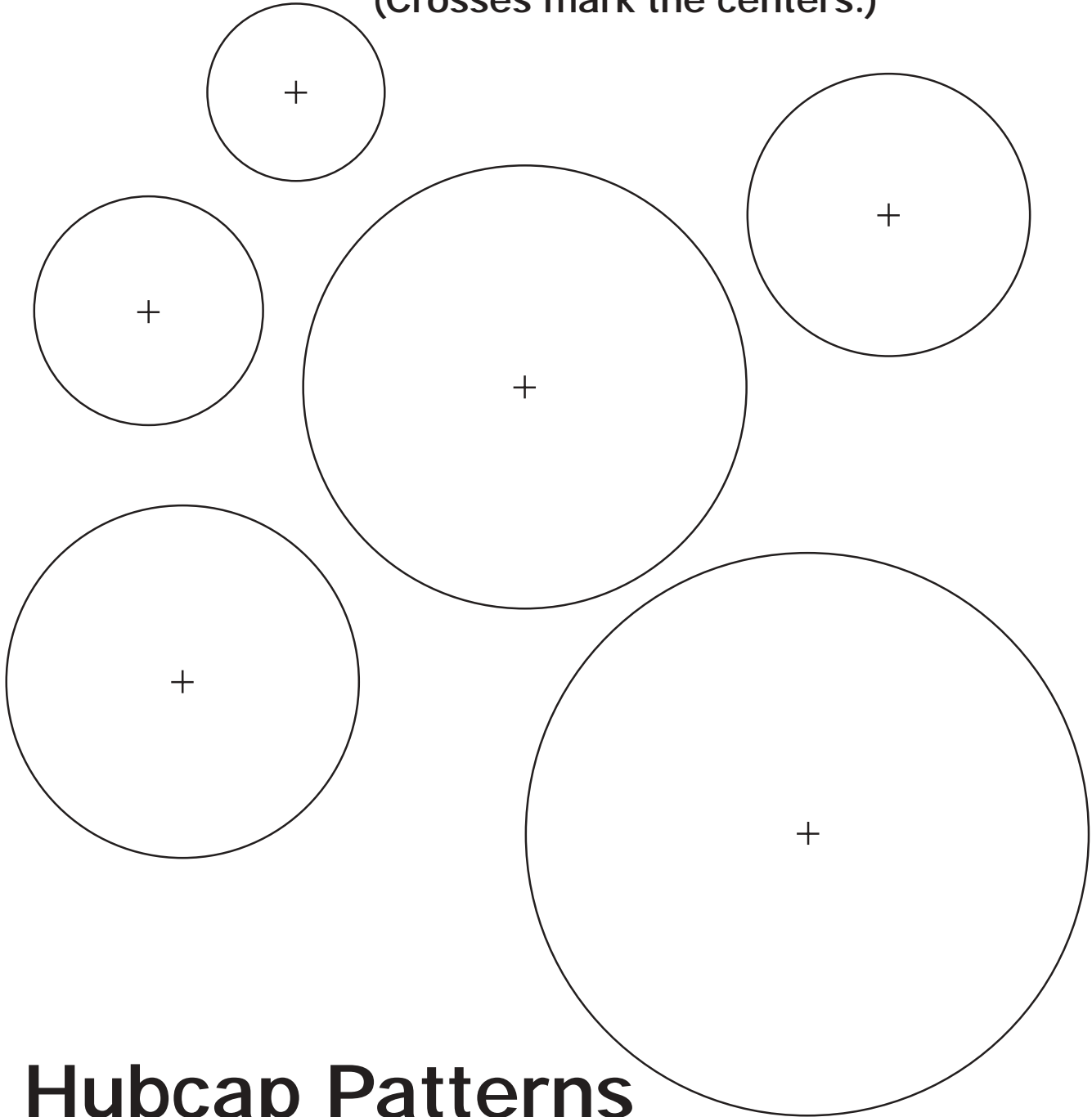

Hubcap Patterns

(Crosses mark the centers.)

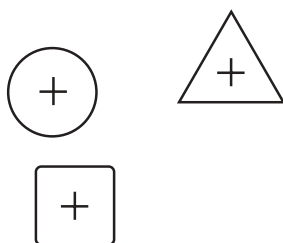

Rocket Racer Test Report

Draw a picture of your rocket racer.

BY

DATE: _____



Rocket Racer Test Report

Place your rocket racer on the test track and measure how far it travels.

1. Describe how your rocket racer ran during the first trial run.
(Did it run on a straight or curved path?)

How far did it go? _____ centimeters

Color in one block on the graph for each 10 centimeters your racer traveled.

2. Find a way to change and improve your rocket racer and test it again.

What did you do to improve the rocket racer for the second trial run?

How far did it go? _____ centimeters

Color in one block on the graph for each 10 centimeters your racer traveled.

3. Find a way to change and improve your rocket racer and test it again.

What did you do to improve the rocket racer for the third trial run?

How far did it go? _____ centimeters

Color in one block on the graph for each 10 centimeters your racer traveled.

4. In which test did your racer go the farthest? _____

Why? _____





Rocket Racer Data Sheet

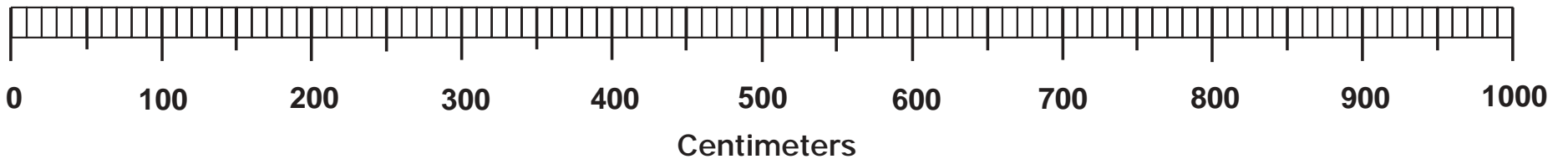
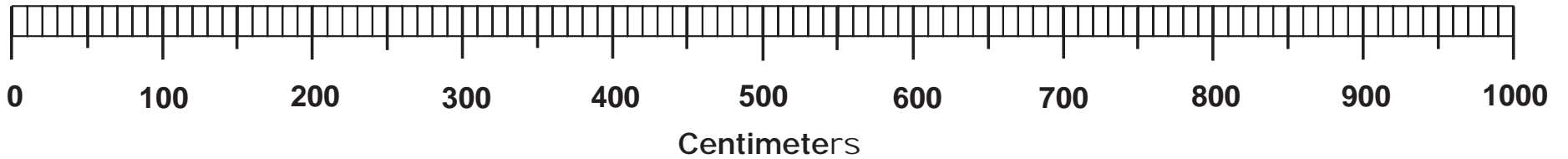
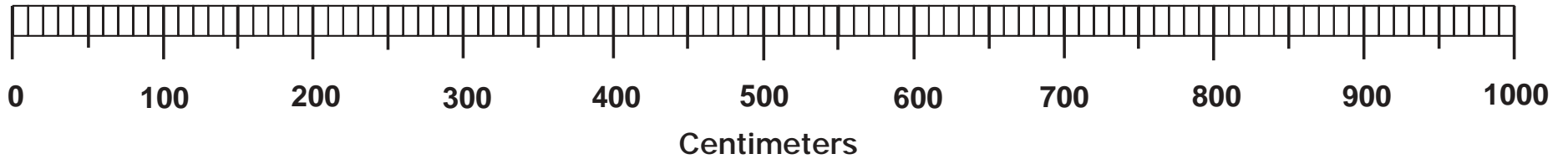

DESIGN SHEET

Design and build a new rocket racer based on your earlier experiments.

Front View

Top View

Side View



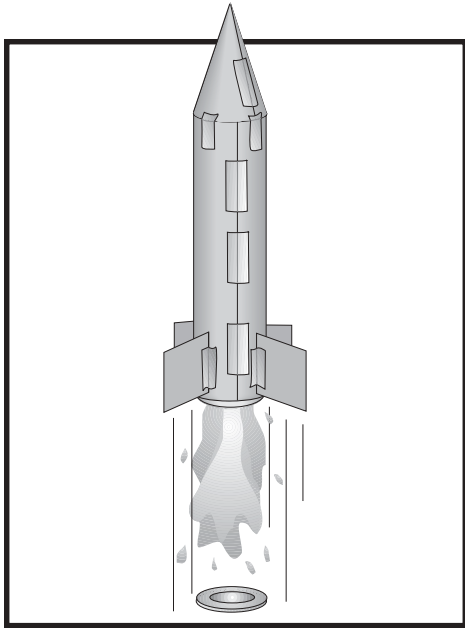

Educator Information

3-2-1 POP!

Objective:

To demonstrate how rocket liftoff is an application of Newton's Laws of Motion.

Description:

Students construct a rocket powered by the pressure generated from an effervescent antacid tablet reacting with water.

Science Standards:

Physical Science - Position and motion of objects
Science and Technology - Abilities of technological design - Understanding about science and technology

Process Skills:

Observing
Communicating
Making Models
Inferring

Management:

For best results, students should work in pairs. It will take approximately 40 to 45 minutes to complete the activity. Make samples of rockets in various stages of completion available for students to study. This will help some students visualize the construction steps.

A single sheet of paper is sufficient to make a rocket. Be sure to tell the students to plan how they are going to use the paper. Let the students decide whether to cut the paper the short or long direction to make the body tube of the rocket. This will lead to rockets of different lengths for flight comparison.

The most common mistakes in constructing the rocket are: forgetting to tape the film canister to the rocket body, failing to mount the canister with the lid end down, and not extending the canister far enough from the paper tube to make snapping the lid easy. Some students may have difficulty in forming the cone. To make a cone, cut out a pie shape from a circle and curl it into a cone. See the pattern on the next page. Cones can be any size.

Materials and Tools:

- Heavy paper (60-110 index stock or construction paper)
 - Plastic 35 mm film canister*
 - Student sheets
 - Cellophane tape
 - Scissors
 - Effervescent antacid tablet
 - Paper towels
 - Water
 - Eye protection
- * The film canister must have an internal-sealing lid. See management section for more details.



Film canisters are available from camera shops and stores where photographic processing takes place. These businesses recycle the canisters and are often willing to donate them for educational use. Be sure to obtain canisters with the internal sealing lid. These are usually translucent canisters. Canisters with the external lid (lid that wraps around the canister rim) will not work. These are usually opaque canisters.

Background Information:

This activity is a simple but exciting demonstration of Newton's Laws of Motion. The rocket lifts off because it is acted upon by an unbalanced force (First Law). This is the force produced when the lid blows off by the gas formed in the canister. The rocket travels upward with a force that is equal and opposite to the downward force propelling the water, gas, and lid (Third Law). The amount of force is directly proportional to the mass of water and gas expelled from the canister and how fast it accelerates (Second Law). For a more complete discussion of Newton's Laws of Motion, see pages 13-17 in this guide.

Procedure:

Refer to the Student Sheet.

Discussion:

- How does the amount of water placed in the cylinder affect how high the rocket will fly?
- How does the temperature of the water affect how high the rocket will fly?
- How does the amount of the tablet used affect how high the rocket will fly?
- How does the length or empty weight of the rocket affect how high the rocket will fly?
- How would it be possible to create a two-stage rocket?

Assessment:

Ask students to explain how Newton's Laws of Motion apply to this rocket. Compare the rockets for skill in construction. Rockets that use excessive paper and tape are likely to be less efficient fliers because they carry additional weight.

Extensions:

- Hold an altitude contest to see which rockets fly the highest. Launch the rockets near a wall in a room with a high ceiling. Tape a tape measure to the wall. Stand back and observe how high the rockets travel upward along the wall. Let all students take turns measuring rocket altitudes
- What geometric shapes are present in a rocket?
- Use the discussion questions to design experiments with the rockets. Graph your results.



3-2-1 POP!

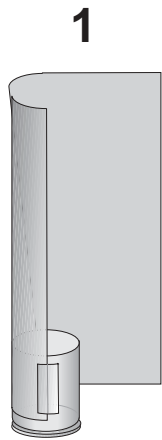

Wrap and tape a tube of paper around the film canister. The lid end of the canister goes down!

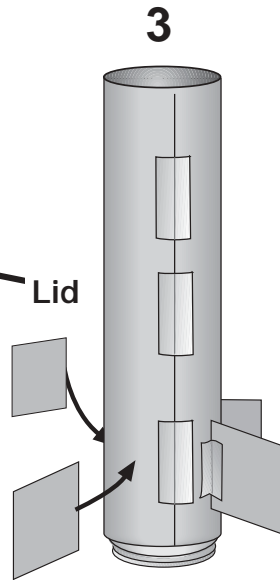
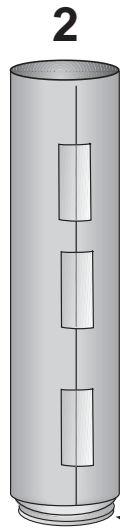

Tape fins to your rocket.

Ready for flight

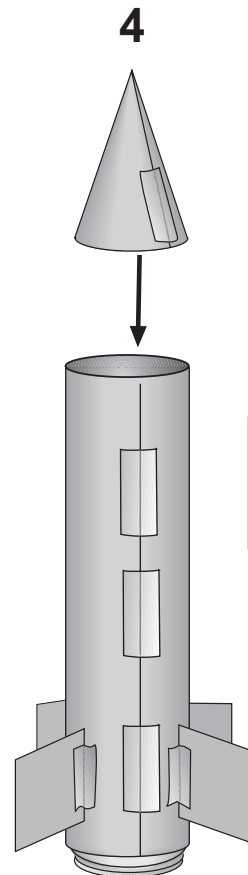

Roll a cone of paper and tape it to the rocket's upper end.

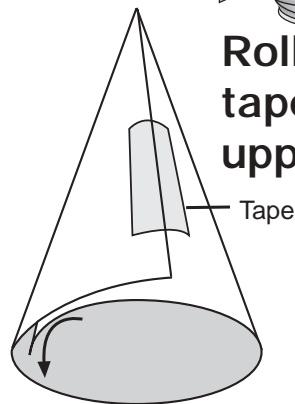
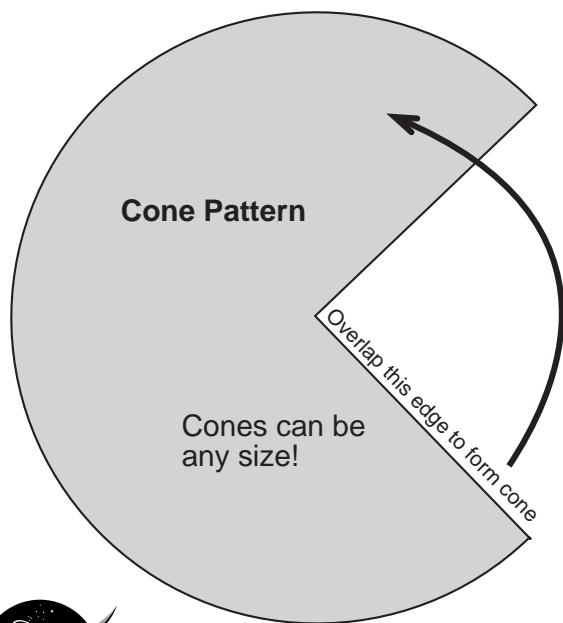
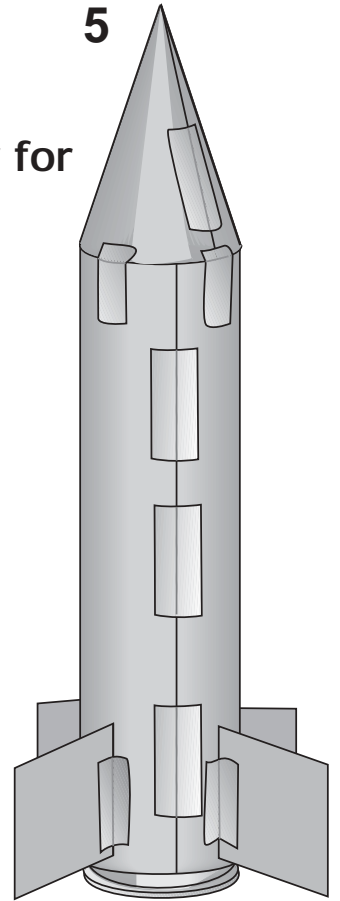

ROCKETEER NAMES

COUNTDOWN:

1. Put on your eye protection.
2. Turn the rocket upside down and fill the canister one-third full of water.

Work quickly on the next steps!

3. Drop in 1/2 tablet.
4. Snap lid on tight.
5. Stand rocket on launch platform.
6. Stand back.

LIFTOFF!

What three ways can you improve your rocket?

1. _____
2. _____
3. _____

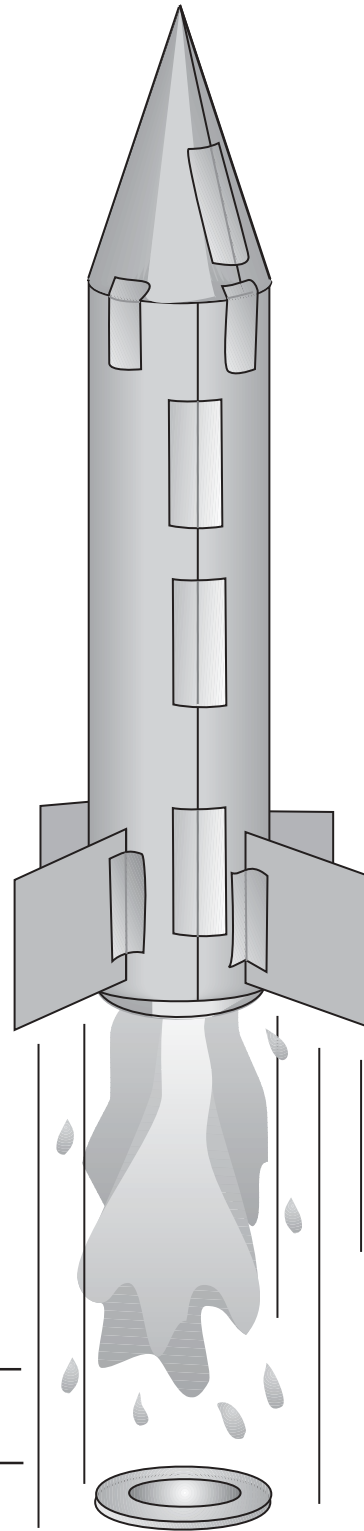

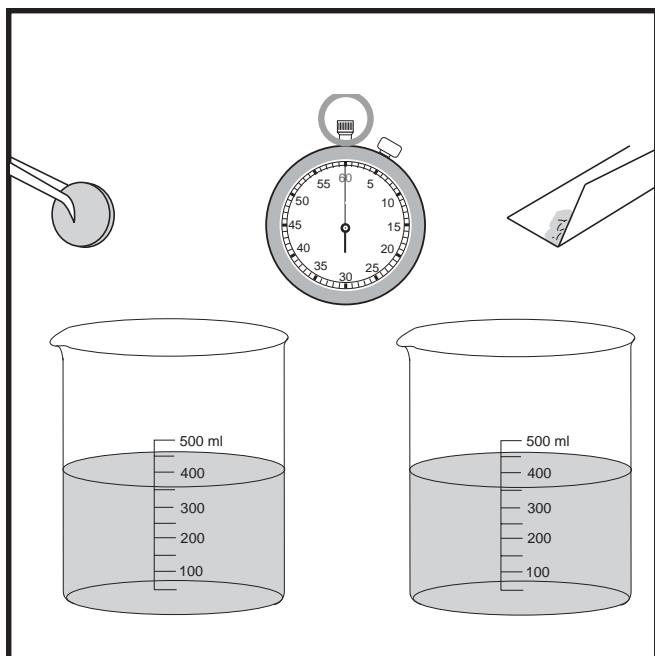

Educator Information

Antacid Tablet Race

Objective:

To investigate methods of increasing the power of rocket fuels by manipulating surface area and temperature.

Description:

Students compare the reaction rates of effervescent antacid tablets under different conditions.

Science Standards:

Science as Inquiry
 Physical Science - Properties of objects and materials
 Science and Technology - Abilities of technological design

Science Process Skills:

Observing
 Communicating
 Measuring
 Collecting Data
 Inferring
 Predicting
 Interpreting Data
 Making Graphs
 Hypothesizing
 Controlling Variables
 Investigating

Mathematics Standards:

Mathematics as Communication
 Mathematical Connections
 Estimation
 Measurement
 Statistics and Probability

Management:

This activity should be done in groups of two or three students. The specific brand of effervescent antacid tablets used for the experiment is not important, but different brands should not be mixed during

the experiments. Give student groups only two tablets at a time. Make sure they know how to fill in the stopwatch graphs on the student pages. Although there is little eye hazard involved with the experiment, it is valuable for students to get in the habit of wearing eye protection for experiments involving chemicals.

Background Information:

This activity enables students to discover methods of increasing the rate that rocket propellants release energy. When rocket propellants burn faster, the mass of exhaust gases expelled increases as well as how fast those gases accelerate out of the rocket nozzle. Newton's Second Law of Motion

Materials and Tools:

- Effervescent Antacid tablets (four per group)
- Two beakers (or glass or plastic jars)
- Tweezers or forceps
- Scrap paper
- Watch or clock with second hand
- Thermometer
- Eye protection
- Water (warm and cold)



states that the force or action of a rocket engine is directly proportional to the mass expelled times its acceleration. Consequently, increasing the efficiency of rocket fuels increases the performance of the rocket.

Students will discover two methods for increasing the efficiency of rocket fuels by using antacid tablets. The first experiment measures the relationship between the surface area of a tablet and its reaction rate in water. Students will learn that increasing the surface area of a tablet by crushing it into a powder, increases its reaction rate with the water. This is a similar situation to the way a rocket's thrust becomes greater by increasing the burning surface of its propellants.

Expanding the burning surface increases its burning rate. In solid rockets, a hollow core extending the length of the propellant permits more propellant to burn at a time. This increases the amount of gas (mass) and acceleration of the gas as it leaves the rocket engine. Liquid propellants spray into the combustion chamber of a liquid propellant rocket to maximize their surface area. Smaller droplets react more quickly than do large ones, increasing the acceleration of the escaping gases. (See page 20 for more information.)

The second experiment measures the reaction rate of tablets in different water temperatures. Tablets in warm water react much more quickly than tablets in cold water. In liquid propellant rocket engines, super cold fuel, such as liquid hydrogen, is preheated before being combined with liquid oxygen. This increases the reaction rate and thereby increases the rocket's thrust. More information about this process appears on page 20.

Assessment:

Conduct a class discussion where students explain how this experiment relates to the way rocket fuel burns. Collect and review completed student pages.

Extensions:

- Try a similar activity relating to the surface area of rocket fuels using small pieces of hard candy. Take two pieces of candy and crush one. Then, give the whole candy piece to one student and the crushed candy to another student to dissolve in their mouths. Which candy will dissolve first?



Antacid Tablet Race Experiment 1

Team _____
Members: _____

1. Fill both jars half full with water that is at the same temperature.
2. Put on your eye protection.
3. Predict how long it will take for the tablet to dissolve in the water. Drop a tablet in the first jar. Shade in the stopwatch face for the actual number of minutes and seconds it took to complete the reaction. The stopwatch can measure six minutes.
4. Wrap another tablet in paper and place it on a table top. Crush the tablet with the wood block.
5. Predict how long it will take for the crushed tablet to dissolve. Drop the powder in the other jar. Shade in the clock face for the number of minutes and seconds it took to complete the reaction.

Describe what happened in the experiment and why.

Jar 1 Results

Your Prediction: _____ seconds

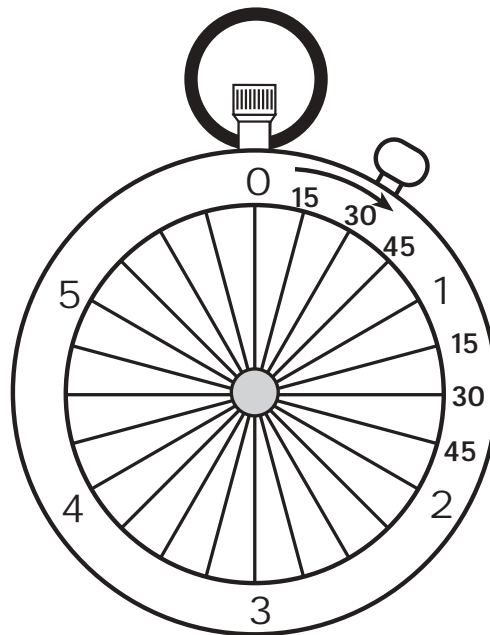

Jar 2 Results

Your Prediction: _____ seconds

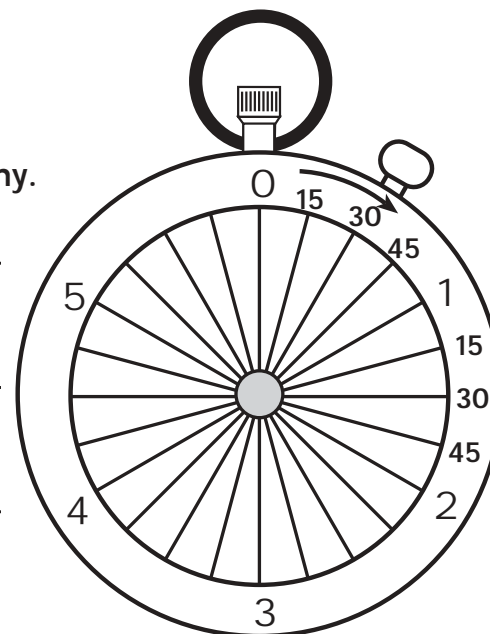

Experiment 2

1. Empty the jars from the first experiment. Put warm water in one jar and cold in the other.
2. Measure the temperature of the first jar. Predict how long it will take for a tablet to dissolve. Drop a tablet in the jar. Shade in the clock face for the actual number of minutes and seconds it took to complete the reaction.
3. Measure the temperature of the second jar. Predict how long it will take for a tablet to dissolve in the water. Drop a tablet in the jar. Shade in the clock face for the actual number of minutes and seconds it took to complete the reaction.

Describe what happened in the experiment and why.

How can you apply the results from these experiments to improve rocket performance?

Jar 1 Results

Temperature: _____ °C
Your Prediction: _____ Seconds

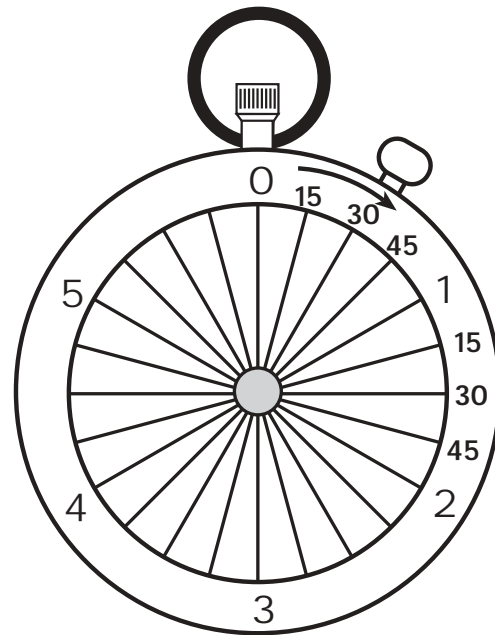

Jar 2 Results

Temperature: _____ °C
Your Prediction: _____ Seconds

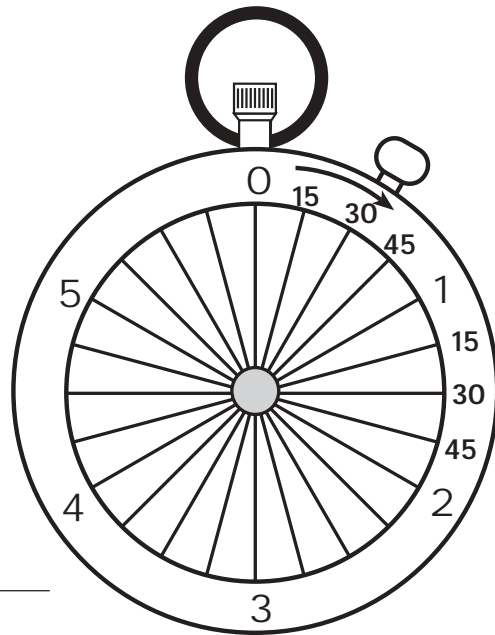

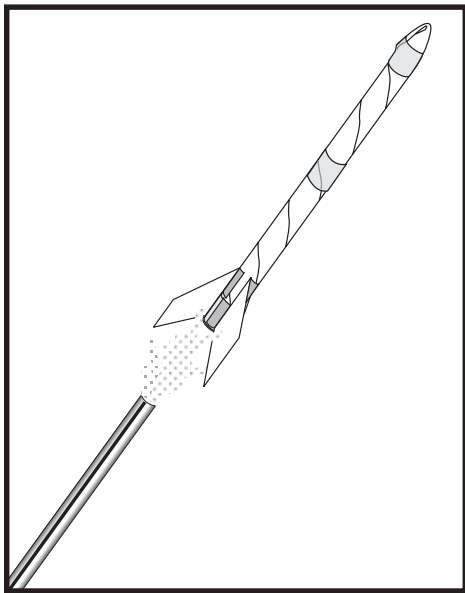

Educator Information

Paper Rockets

Objective:

To design, construct, and fly paper rockets that will travel the greatest distance possible across a floor model of the solar system.

Description:

In this activity, students construct small flying rockets out of paper and propel them by blowing air through a straw.

Science Standards:

- Science as Inquiry
- Physical Science - Position and motion of objects
- Science and Technology - Abilities of technological design
- Unifying Concepts and Processes - Evidence, models, and explanation

Science Process Skills:

- Observing
- Communicating
- Measuring
- Collecting Data
- Inferring
- Predicting
- Making Models
- Interpreting Data
- Controlling Variables
- Defining Operationally
- Investigating

Mathematics Standards:

- Mathematics as Problem Solving
- Mathematics as Reasoning
- Mathematical Connections
- Geometry and Spatial Sense
- Statistics and Probability

Management:

After demonstrating a completed paper rocket to the students, have them construct their own paper rockets and decorate them. Students may work individually or in pairs.

- ★ Because the rockets are projectiles, make sure students wear eye protection.

Materials and Tools:

- Scrap bond paper
- Cellophane tape
- Scissors
- Sharpened fat pencil
- Milkshake straw (slightly thinner than pencil)
- Eye protection
- Metric ruler
- Masking tape or Altitude trackers
- Pictures of the Sun and planets

When students complete the rockets, distribute straws. Select a location for flying the rockets. A room with open floor space or a hallway is preferable. Prepare the floor by marking a 10-meter test range with tape measures or meter sticks laid end to end. As an alternative, lay out the planetary target range as shown on the next page. Have students launch from planet Earth, and tell them to determine the farthest planet they are able to reach with their rocket. Use the planetary arrangement shown on the next page for laying out the launch range. Pictures for the planets are found on page 63. Enlarge these pictures as desired.

Record data from each launch on the Paper Rocket Launch Record Report form. The form includes spaces for data from three different rockets. After the first launches,



students should construct new and "improved" paper rockets and attempt a longer journey through the solar system. Encourage the students to try different sized rockets and different shapes and number of fins. For younger students, create a chart listing how far each planet target is from Earth. Older students can measure these distances for themselves.

Background Information:

Although the activity uses a solar system target range, the Paper Rockets activity demonstrates how rockets fly through the atmosphere. A rocket with no fins is much more difficult to control than a rocket with fins. The placement and size of the fins is critical to achieve adequate stability while not adding too much weight. More information on rocket fins can be found on pages 22-23 of this guide.

Making and Launching Paper Rockets:

1. Distribute the materials and construction tools to each student.
2. Students should each construct a rocket as shown in the instructions on the student sheet.
3. Tell students to predict how far their rocket will fly and record their estimates in the test report sheet. After test flying the rocket and measuring the distance it reached, students should record the actual distance and the difference between predicted and actual distances on the Paper Rockets Test Report.
4. Following the flight of the first rocket, students should construct and test two additional rockets of different sizes and fin designs.

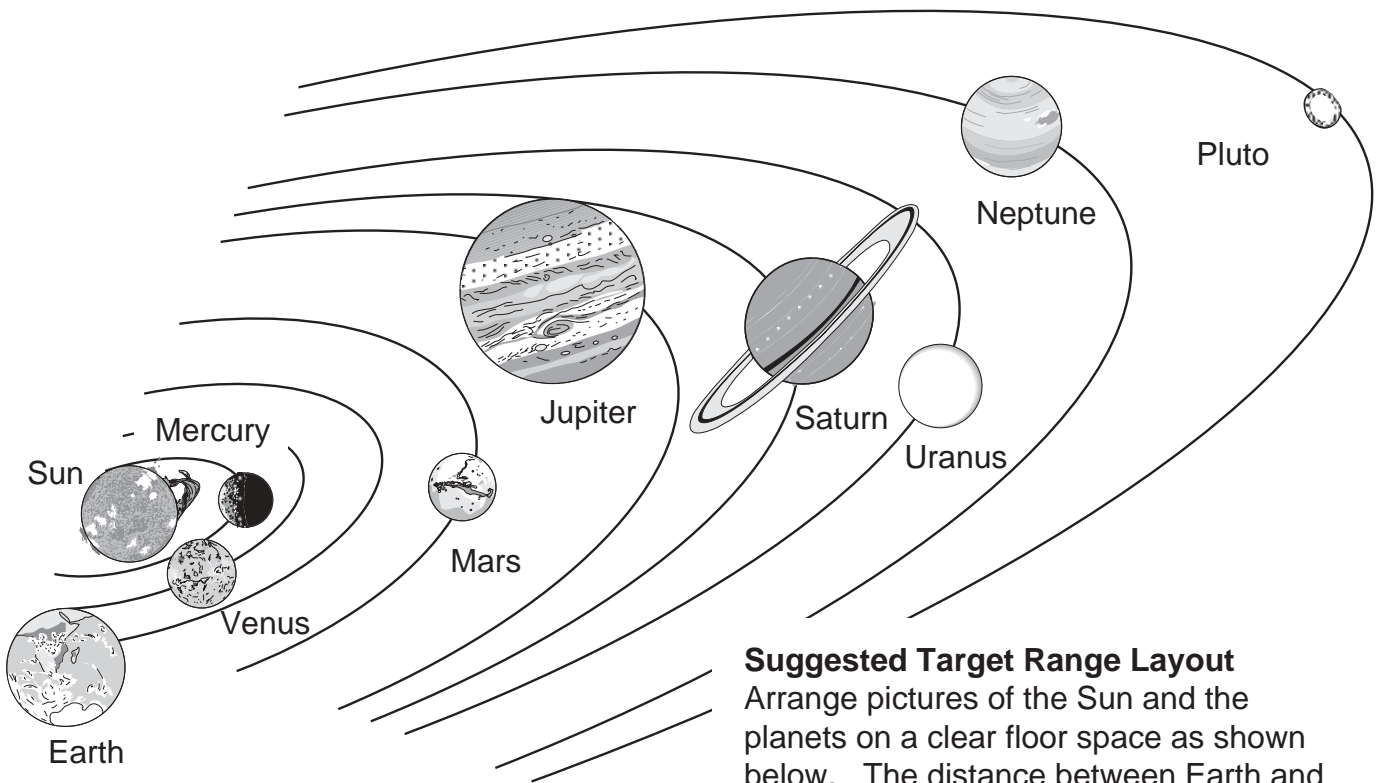

Suggested Target Range Layout

Arrange pictures of the Sun and the planets on a clear floor space as shown below. The distance between Earth and Pluto should be about 8 meters. Refer to an encyclopedia or other reference for a chart on the actual distances to each planet.



Planet Targets

(Not Drawn To Scale)

Enlarge these pictures on a copy machine or sketch copies of the pictures on separate paper. Place these pictures on the floor according to the arrangement on the previous page. If you wish to make the planets to scale, refer to the numbers beside the names indicating the relative sizes of each body. Earth's diameter is given as one and all the other bodies are given as multiples of one.

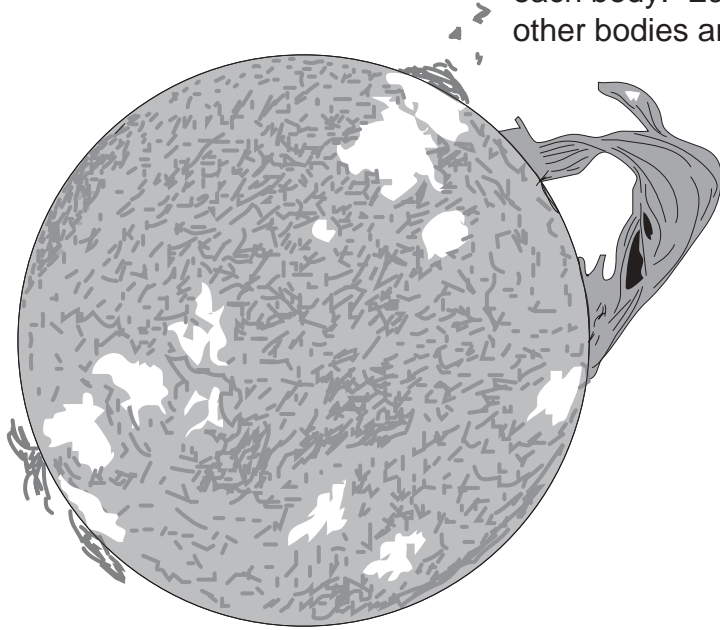

Sun
108X

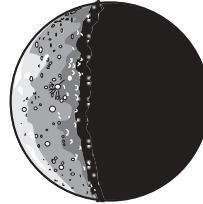

Mercury
0.38X

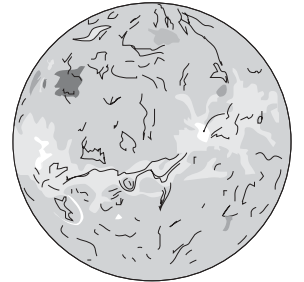

Venus
0.95X

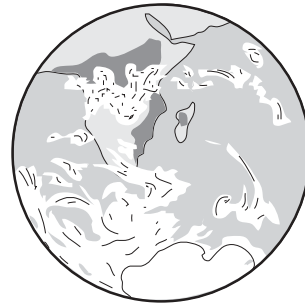

Earth
1X

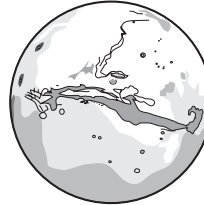

Mars
0.53X

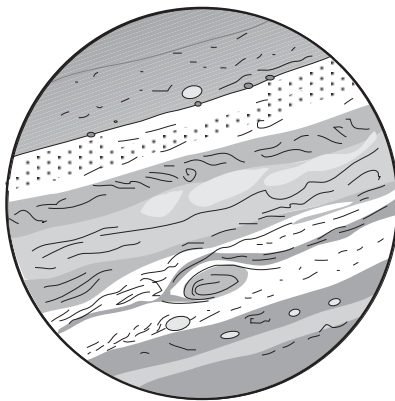

Jupiter
11.2X

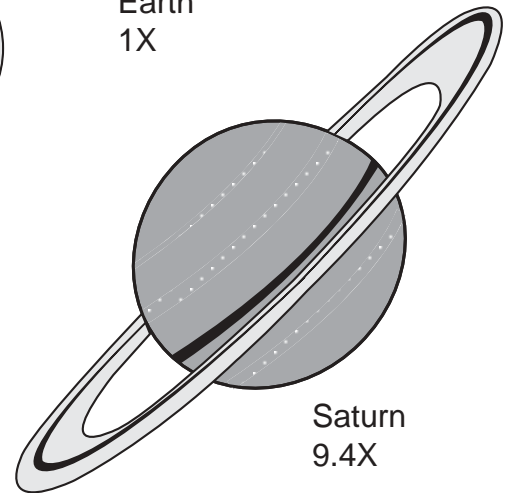

Saturn
9.4X

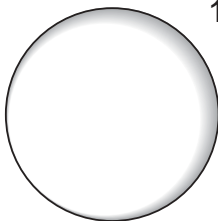

Uranus
4X

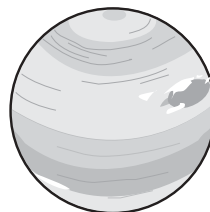

Neptune
3.9X



Pluto
0.9X



Discussion:

1. What makes one rocket perform better than another? (Do not forget to examine the weight of each rocket. Rockets made with extra tape and larger fins weigh more.)
2. How small can the fins be and still stabilize the rocket?
3. How many fins does a rocket need to stabilize it?
4. What would happen if you placed the rocket fins near the rocket's nose?
5. What will happen to the rocket if you bend the lower tips of the fins pinwheel fashion?
6. Are rocket fins necessary in outer space?

Extensions:

Try to determine how high the rockets fly. To do so, place masking tape markers on a wall at measured distances from the floor to the ceiling. While one student launches the rocket along the wall, another student compares the height the rocket reached with the tape markers. Be sure to have the students subtract the height from where the rocket was launched from the altitude reached. For example, if students held the rocket 1.5 meters from the floor to launch it, and it reached 4 meters above the floor, the actual altitude change was 2.5 meters. Refer to the Altitude Tracker activity starting on page 79 for details on a second method for measuring the height the paper rockets reach.

Assessment:

Students will complete test reports that will describe the rockets they constructed and how those rockets performed. Ask the students to create bar graphs on a blank sheet of paper that show how far each of the three rockets they constructed flew. Have students write a summarizing paragraph in which they pick which rocket performed the best and explain their ideas for why it performed as it did.



PAPER ROCKETS

Follow the arrows to build your rocket.

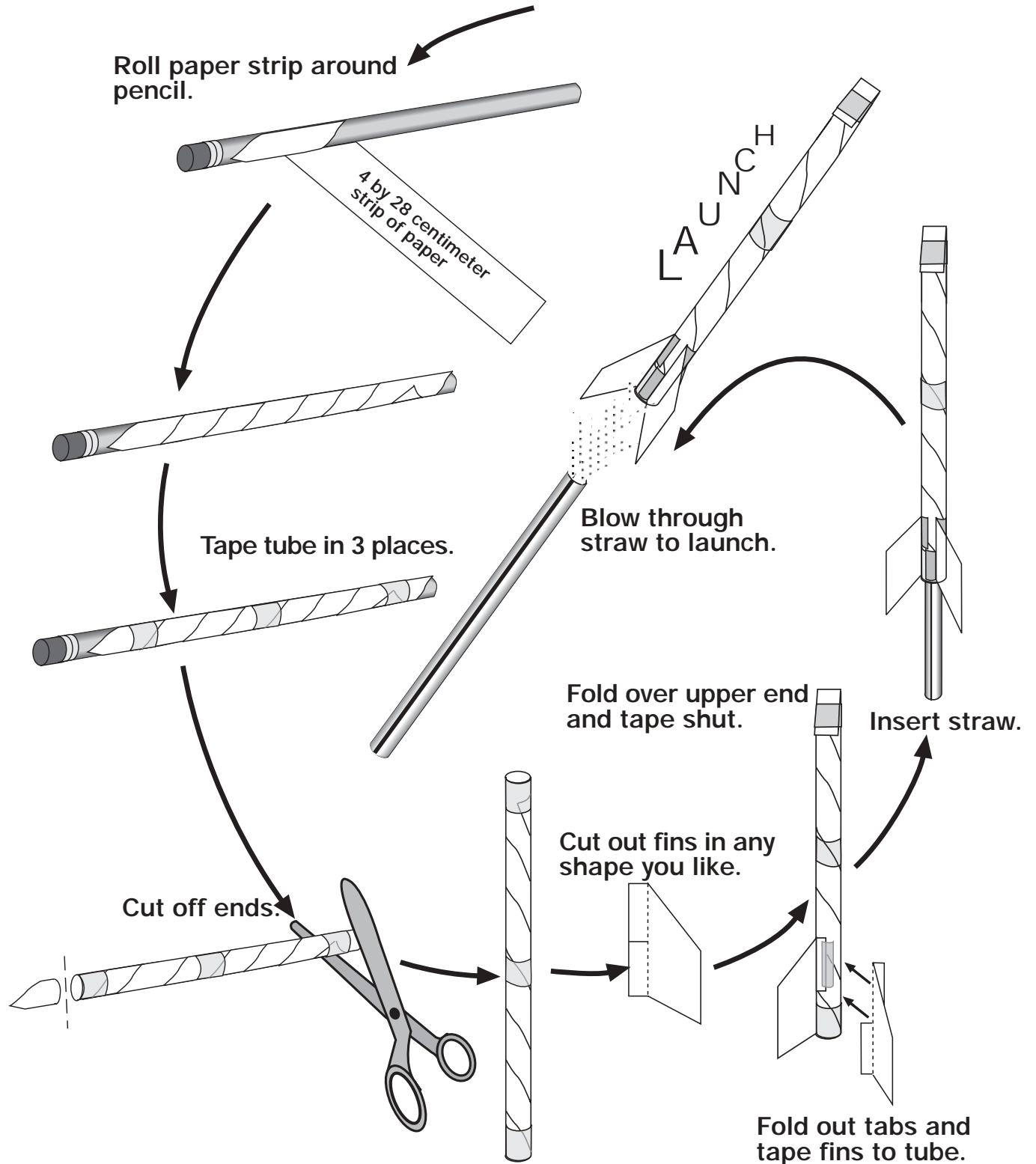

Names: _____

Paper Rocket Test Report

1. Launch your rocket three times. How far did it fly each time. What is the average distance your rocket flew? Write your answer in the spaces below.
2. Build and fly a rocket of a new design. Before flying it, predict how far it will go. Fly the rocket three times and average the distances. What is the difference between your prediction and the actual average distance?
3. Build a third rocket and repeat step 2.
4. On the back of this paper, write a short paragraph describing each rocket you built and how it flew. Draw pictures of the rockets you constructed.

Rocket 1

Make notes about the flights here.

How far did it fly in centimeters?	1. _____ 2. _____ 3. _____	
Average distance in centimeters?	_____	

Rocket 2

Make notes about the flights here.

Predict how many centimeters your rocket will fly.	_____	
How far did it fly in centimeters?	1. _____ 2. _____ 3. _____	
Average distance?	_____	
Difference between your prediction and the average distance?	_____	

Rocket 3

Make notes about the flights here.

Predict how many centimeters your rocket will fly.	_____	
How far did it fly in centimeters?	1. _____ 2. _____ 3. _____	
Average distance?	_____	
Difference between your prediction and the average distance?	_____	



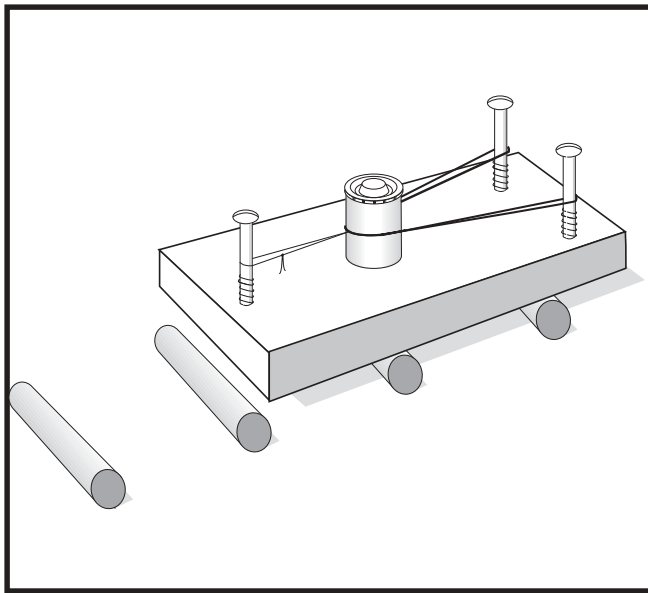

Educator Information

Newton Car

Objective:

To investigate how increasing the mass of an object thrown from a Newton Car affects the car's acceleration over a rolling track (Newton's Second Law of Motion).

Description:

In this activity, students test a slingshot-like device that throws a mass causing the car to move in the opposite direction.

Science Standards:

Science as Inquiry
 Physical Science - Properties of objects and materials
 Unifying Concepts and Processes - Evidence, models, and explanation
 Unifying Concepts and Processes - Change, constancy, and measurement

Science Process Skills:

Observing
 Communicating
 Measuring
 Collecting Data
 Inferring
 Predicting
 Interpreting Data
 Making Graphs
 Controlling Variables
 Defining Operationally
 Investigating

Mathematics Standards:

Mathematics as Problem Solving
 Mathematics as Communication
 Mathematical Connections
 Measurement
 Statistics and Probability
 Patterns and Relationships

Management:

Conduct this activity in groups of three students. Use a smooth testing surface such as a long, level table top or uncarpeted floor. The experiment has many variables that students must control including: the

size of the string loop they tie, the placement of the mass on the car, and the placement of the dowels. Discuss the importance of controlling the variables in the experiment with your students.

Making the Newton Car involves cutting blocks of wood and driving three screws into each block. Refer to the diagram on this page for the placement of the screws as well as how the Newton Car is set up for the experiment. Place the dowels in a row like railroad ties and extend them to one side as shown in the picture. If you have access to a

Materials and Tools:

- 1 Wooden block about 10 x 20 x 2.5 cm
- 3 3-inch No. 10 wood screws (round head)
- 12 Round pencils or short lengths of similar dowel
- Plastic film canister
- Assorted materials for filling canister (e.g. washers, nuts, etc.)
- 3 Rubber bands
- Cotton string
- Safety lighter
- Eye protection for each student
- Metric beam balance (Primer Balance)
- Vice
- Screwdriver
- Meter stick



drill press, you can substitute short dowels for the screws. It is important to drill the holes for the dowels perpendicular into the block with the drill press. Add a drop of glue to each hole.

The activity requires students to load their "slingshot" by stretching the rubber bands back to the third screw and holding it in place with the string. The simplest way of doing this is to tie the loop first and slide the rubber bands through the loop before placing the rubber bands over the two screws. Loop the string over the third screw after stretching the rubber bands back.

Use a match or lighter to burn the string. The small ends of string left over from the knot acts as a fuse that permits the students to remove the match before the string burns through. Teachers may want to give student groups only a few matches at a time. To completely conduct this experiment, student groups will need six matches. It may be necessary for a practice run before starting the experiment. As an alternative to the matches, students can use blunt nose scissors to cut the string. This requires some fast movement on the part of the student doing the cutting. The student needs to move the scissors quickly out of the way after cutting the string.

Tell the students to tie all the string loops they need before beginning the experiment. The loops should be as close to the same size as possible. Refer to the diagram on the student pages for the actual size of the loops. Loops of different sizes will introduce a significant variable into the experiment, causing the rubber bands to be stretched different amounts. This will lead to different accelerations with the mass each time the experiment is conducted.

Use plastic 35 millimeter film canisters for the mass in the experiments. Direct students to

completely fill the canister with various materials, such as seeds, small nails, metal washers, sand, etc. This will enable them to vary the mass twice during the experiment. Have students weigh the canister after it is filled and record the mass on the student sheet. After using the canister three times, first with one rubber band and then two and three rubber bands, students should refill the canister with new material for the next three tests.

Refer to the sample graph for recording data. The bottom of the graph is the distance the car travels in each test. Students should plot a dot on the graph for the distance the car traveled. The dot should fall on the y-axis line representing the number of rubber bands used and on the x-axis for the distance the car traveled. After plotting three tests with a particular mass, connect the dots with lines. The students should use a solid line for Mass 1 and a line with large dashes for Mass 2. If the students have carefully controlled their variables, they should observe that the car traveled the greatest distance using the greatest mass and three rubber bands. This conclusion will help them conceptualize Newton's Second Law of Motion.

Background Information:

The Newton car provides an excellent tool for investigating Isaac Newton's Second Law of Motion. The law states that force equals mass times acceleration. In rockets, the force is the action produced by gas expelled from the engines. According to the law, the greater the gas that is expelled and the faster it accelerates out of the engine, the greater the force or thrust. More details on this law can be found on page 16 of this guide.

The Newton Car is a kind of a slingshot. A wooden block with three screws driven into it forms the slingshot frame. Rubber bands



stretch from two of the screws and hold to the third by a string loop. A mass sits between the rubber bands. When the string is cut, the rubber bands throw the block to produce an action force. The reaction force propels the block in the opposite direction over some dowels that act as rollers (Newton's Third Law of Motion).

This experiment directs students to launch the car while varying the number of rubber bands and the quantity of mass thrown off. They will measure how far the car travels in the opposite direction and plot the data on a graph. Repeated runs of the experiment should show that the distance the car travels depends on the number of rubber bands used and the quantity of the mass being expelled. Comparing the graph lines will lead students to Newton's Second Law of Motion.

Discussion:

1. How is the Newton Car similar to rockets?
2. How do rocket engines increase their thrust?
3. Why is it important to control variables in an experiment?

Assessment:

Conduct a class discussion where students share their findings about Newton's Laws of Motion. Ask them to compare their results with those from previous activities such as Pop Can Hero Engine. Collect and review completed student pages.

Extensions:

Obtain a toy water rocket from a toy store. Try launching the rocket with only air and then with water and air and observe how far the rocket travels.

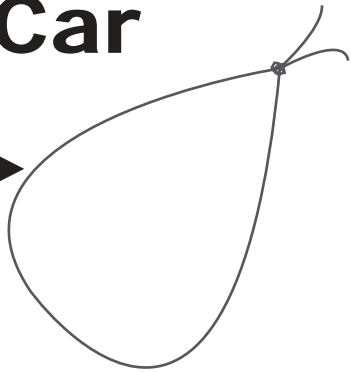

Newton Car

1. Tie 6 string loops this size. 
2. Fill up your film canister and weigh it in grams. Record the mass in the Newton Car Report chart.

3. Set up your Newton Car as shown in the picture. Slip the rubber band through the string loop. Stretch the rubber band over the two screws and pull the string back over the third screw. Place the rods 6 centimeters apart. Use only one rubber band the first time.

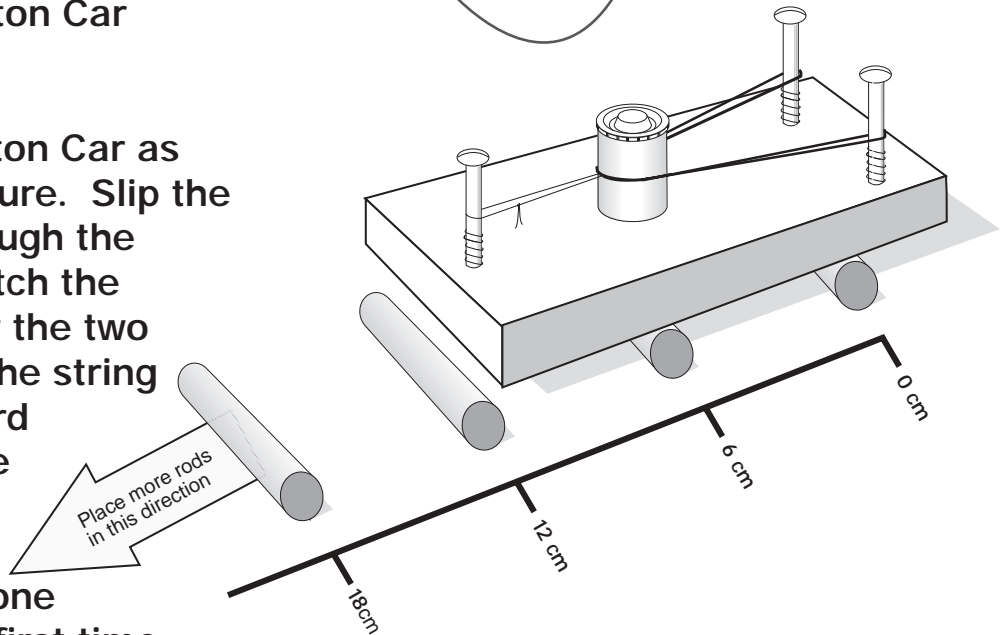

4. Put on your eye protection!
5. Light the string and stand back. Record the distance the car traveled on the chart.
6. Reset the car and rods. Make sure the rods are 6 centimeters apart! Use two rubber bands. Record the distance the car travels.
7. Reset the car with three rubber bands. Record the distance it travels.
8. Refill the canister and record its new mass.
9. Test the car with the new canister and with 1, 2, and 3 rubber bands. Record the distances the car moves each time.
10. Plot your results on the graph. Use one line for the first set of measurements and a different line for the second set.



Newton Car Report

Team _____
 Members: _____

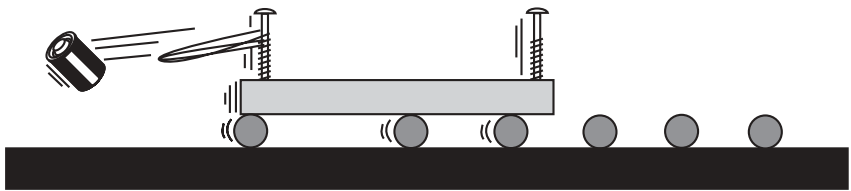

MASS 1

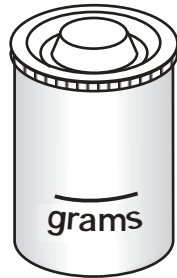

Rubber Bands	Distance Traveled
	_____ centimeters
	_____ centimeters
	_____ centimeters

Describe what happened when you tested the car with 1, 2, and 3 rubber bands.

MASS 2

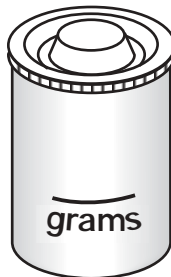

Rubber Bands	Distance Traveled
	_____ centimeters
	_____ centimeters
	_____ centimeters

Describe what happened when you tested the car with 1, 2, and 3 rubber bands.

Write a short statement explaining the relationship between the amount of mass in the canister, the number of rubber bands, and the distance the car traveled.



Newton Car Test Results

Mass 1 = _____ gms

Mass 2 = _____ gms

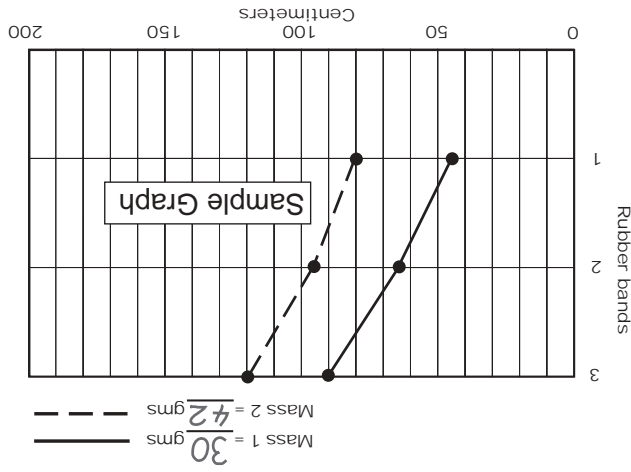
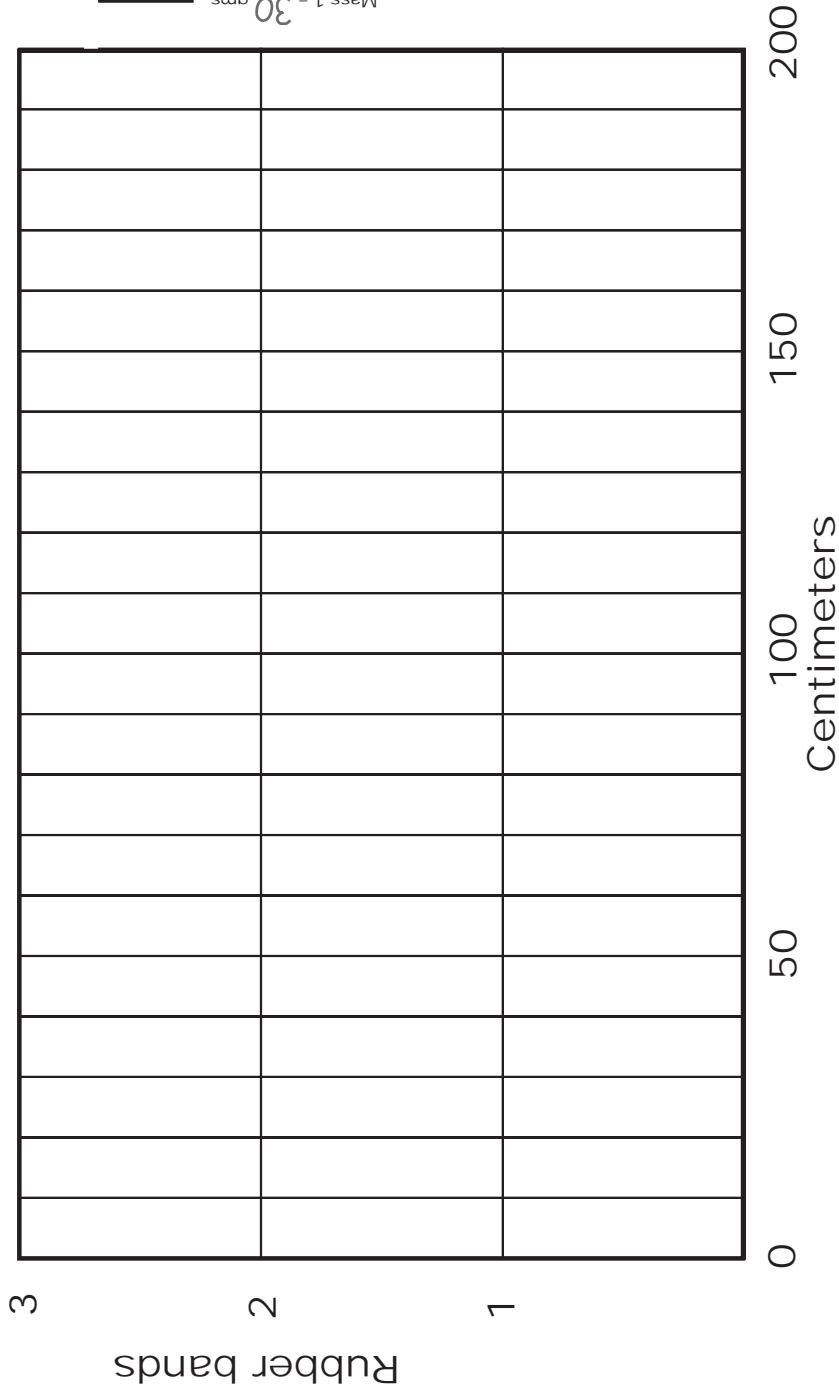
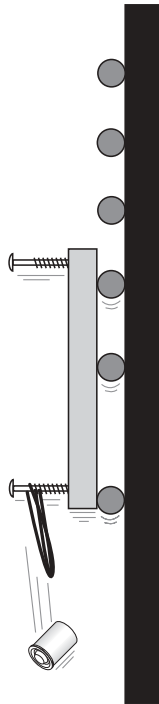

Newton Car Test Results

Mass 1 = _____ gms

Mass 2 = _____ gms

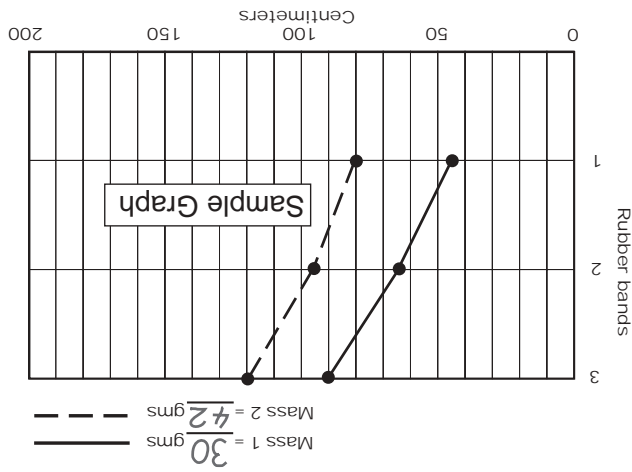
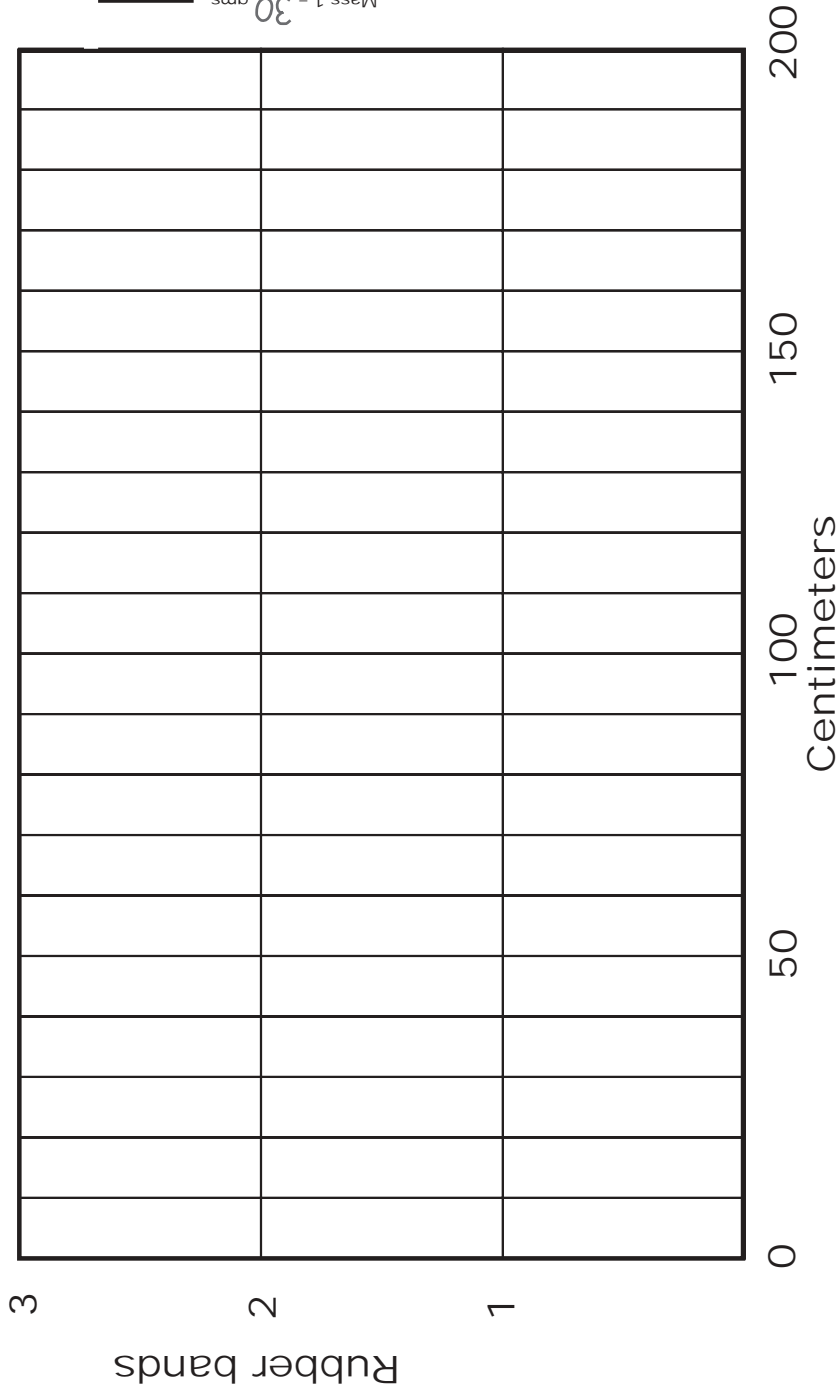
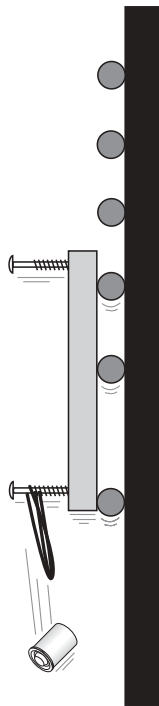

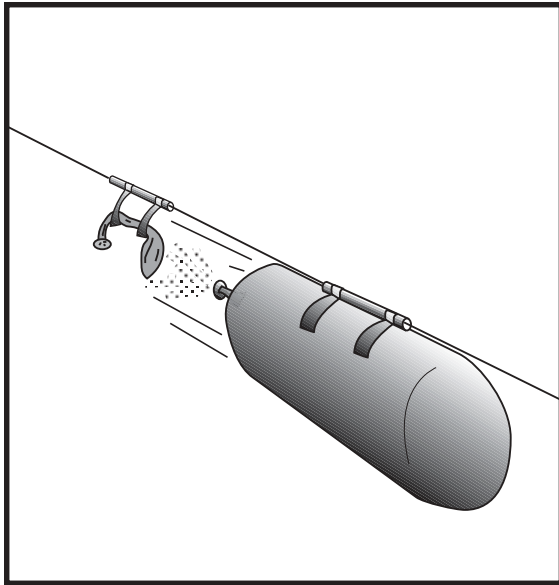

Educator Information

Balloon Staging

Objective:

To demonstrate how rockets can achieve greater altitudes by using the technology of staging.

Description:

This demonstration simulates a multistage rocket launch by using two inflated balloons that slide along a fishing line by the thrust produced from escaping air.

Science Standards:

Physical Science - Position and motion of objects
Science and Technology - Abilities of technological design
Science and Technology - Understanding about science and technology

Science Process Skills:

Observing
Making Models
Defining Operationally

Management:

The activity described below can be done by students or used as a demonstration. Younger students may have difficulty in coordinating the assembly steps to achieve a successful launch. If you will use the activity in several successive classes, consider attaching the fishing line along one wall where there is not much traffic, so students will not walk into the line.

Background Information:

Traveling into outer space takes enormous amounts of energy. This activity is a simple demonstration of rocket staging that Johann Schmidlap first proposed in the 16th century. When a lower stage has exhausted its load of propellants, the entire stage drops away, making the upper stages more efficient in reaching higher altitudes. In the

typical rocket, the stages are mounted one on top of the other. The lowest stage is the largest and heaviest. In the Space Shuttle, the stages attach side by side. The solid rocket boosters attach to the side of the external tank. Also attached to the external tank is the Shuttle orbiter. When exhausted the solid rocket boosters jettison. Later, the orbiter discards the external tank as well.

Procedure:

1. Thread the fishing line through the two straws. Stretch the fishing line snugly across a room and secure its ends. Make sure the line is just high enough for people to pass safely underneath.
2. Cut the coffee cup in half so that the lip of the cup forms a continuous ring.
3. Stretch the balloons by pre-inflating them.

Materials and Tools:

- 2 Long party balloons
- Nylon monofilament fishing line (any weight)
- 2 Plastic straws (milkshake size)
- Styrofoam coffee cup
- Masking tape
- Scissors
- 2 Spring clothespins



Inflate the first balloon about three-fourths full of air and squeeze its nozzle tight. Pull the nozzle through the ring. Twist the nozzle and hold it shut with a spring clothespin. Inflate the second balloon.

While doing so, make sure the front end of the second balloon extends through the ring a short distance. As the second balloon inflates, it will press against the nozzle of the first balloon and take over the clip's job of holding it shut. It may take a bit of practice to achieve this. Clip the nozzle of the second balloon shut also.

4. Take the balloons to one end of the fishing line and tape each balloon to a straw with masking tape. The balloons should point parallel to the fishing line.
5. Remove the clip from the first balloon and untwist the nozzle. Remove the nozzle from the second balloon as well, but continue holding it shut with your fingers.
6. If you wish, do a rocket countdown as you release the balloon you are holding. The escaping gas will propel both balloons along the fishing line. When the first balloon released runs out of air, it will release the other balloon to continue the trip.
7. Distribute design sheets and ask students to design and describe their own multistage rocket.

Assessment:

Collect and display student designs for multistage rockets. Ask each student to explain their rocket to the class.

Extensions:

- Encourage the students to try other launch arrangements such as side-by-side balloons and three stages.
- Can students fly a two stage balloon without the fishing line as a guide? How might the balloons be modified to make this possible?

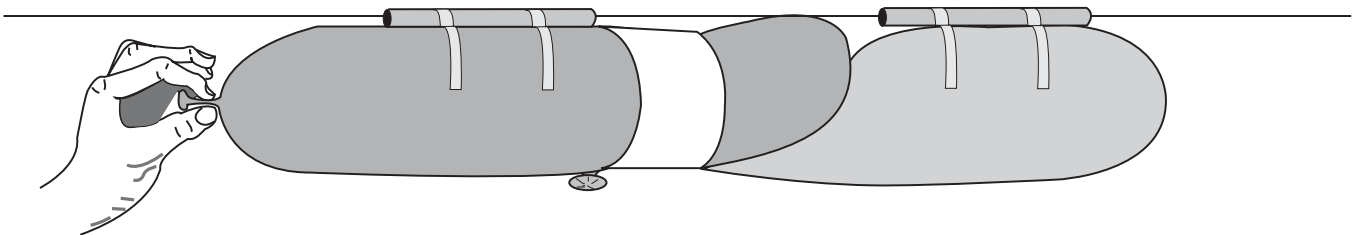

Design Sheet

Design a rocket that has at least two stages. In the space below, describe what each stage will do. Do not forget to include a place for payload and crew.

Top View

Description

Your Name: _____

Rocket Name: _____

Side View



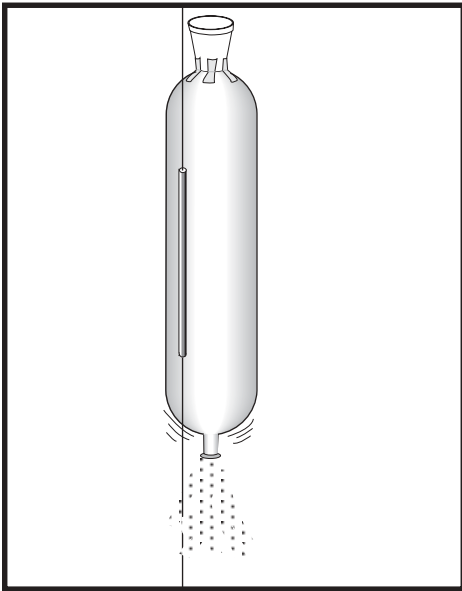

Educator Information

Rocket Transportation

Objective:

To problem solve ways to lift a load using a balloon rocket.

Description:

Students construct a rocket out of a balloon and use it to carry a paper clip payload.

Science Standards:

Science as Inquiry
Physical Science - Position and motion of objects
Science and Technology - Abilities of technological design

Science Process Skills:

Observing
Communicating
Measuring
Collecting Data
Inferring
Predicting
Making Models
Controlling Variables
Defining Operationally
Investigating

Mathematics Standards:

Problem Solving
Communication
Reasoning
Connections
Estimation
Measurement

Management:

This activity works best with students working in teams of three or four. It will take approximately one hour to complete. The activity focuses on the scientific processes of experimentation.

Background Information:

The mass of a rocket can make the difference between a successful flight and a rocket that just sits on the launch pad. As a basic principle of rocket flight, a rocket will leave the ground when the engine produces a thrust that is greater than the total mass of the vehicle.

Large rockets, able to carry a spacecraft into space, have serious weight problems. To reach space and proper orbital velocities, a great deal of propellant is needed; therefore, the tanks, engines, and associated hardware become larger. Up to a point, bigger rockets fly farther than smaller rockets, but when they become too large their structures weigh them down too much.

Materials and Tools:

- Large long balloons (Several per group)
- Fishing line
- Straws
- Small paper cups
- Paper clips
- Tape
- Clothes pins
- Scales



A solution to the problem of giant rockets weighing too much can be credited to the 16th-century fireworks maker John Schmidlap. Schmidlap attached small rockets to the top of big ones. When the large rockets exhausted their fuel supply the rocket casing dropped behind and the remaining rocket fired. Much higher altitudes can be achieved this way.

This technique of building a rocket is called staging. Thanks to staging, we can not only reach outer space in the Space Shuttle, but also the Moon and other planets using various spacecraft.

Procedure:

1. Attach a fishing line to the ceiling or as high on the wall as possible. Try attaching a paper clip to a fishing line and hooking it on to the light or ceiling tile braces. Make one drop with the fishing line to the floor or table top per group. Note: The line may be marked off in metric units with a marker to aid students in determining the height traveled.
2. Blow up the balloon and hold it shut with a clothes pin. You will remove the clip before launch.
3. Use the paper cup as a payload bay to carry the weights. Attach the cup to the balloon using tape. Encourage students to think of creative locations to attach the cup to the balloon.
4. Attach the straw to the side of your rocket using the tape. Be sure the straw runs lengthwise along the balloon. This will be your guide and attachment to your fishing line.
5. Thread the fishing line through the straws. Launch is now possible simply by removing the clothes pin. NOTE: The fishing line should be taut for the rocket to travel successfully up the line, and the clipped balloon nozzle must be untwisted before release.

6. After trying their rocket have students predict how much weight they can lift to the ceiling. Allow students to change their design in any way that might increase the rockets lifting ability between each try (e.g. adding additional balloons, changing locations of the payload bay, replacing the initial balloon as it loses some of its elasticity enabling it to maintain the same thrust, etc.)

Discussion:

1. Compare what you have learned about balloons and rockets.
2. Why is the balloon forced along the string?

Assessment:

Compare results from student launches. Have students discuss design elements that made their launch successful and ideas they think could be used to create an even more successful heavy-lift launcher.

Extensions:

- Can you eliminate the paper cup from the rocket and have it still carry paper clips?
- If each balloon costs one million dollars and you need to lift 100 paper clips, how much money would you need to spend? Can you think of a way to cut this cost?
- Without attaching the paper cup as a payload carrier, have the students measure the distance the balloon travels along the string in a horizontal, vertical, and 45 degree angle using metric units. Discuss the differences.



Rocket Transportation

Rocket Team _____

- Predict how much weight your rocket can lift to the ceiling _____
 (2 small paperclips = approximately 1 gram)

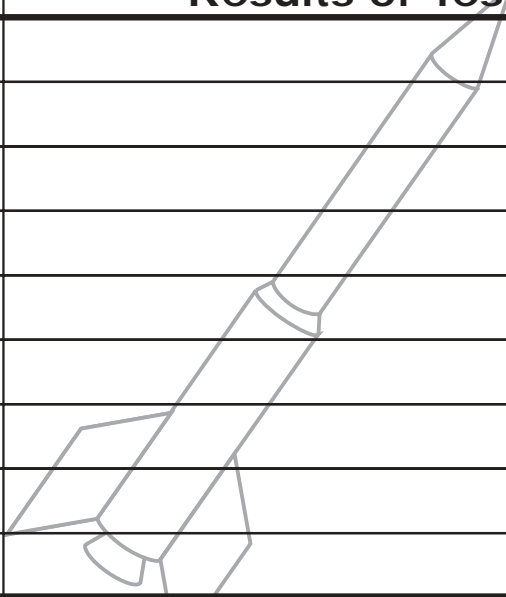
Test	Weight Lifted	Results of Test
1		
2		
3		
4		

Based on your most successful launch:

- What was the maximum amount of weight you could lift to the ceiling? _____

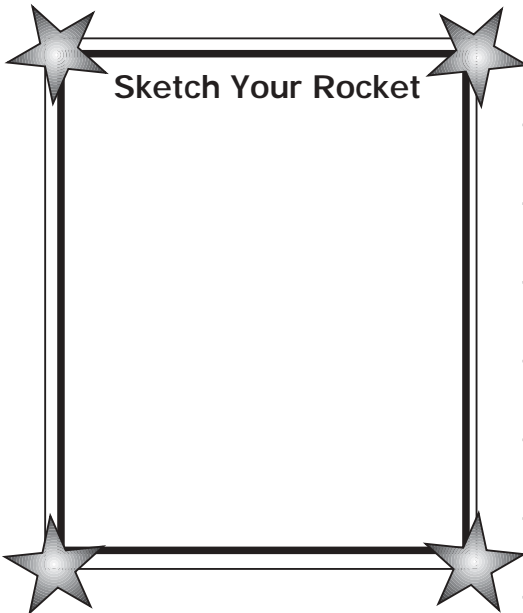

Explain how you designed your rocket to lift the maximum amount of weight.

- What other ways could increase the lifting capacity of your rocket?



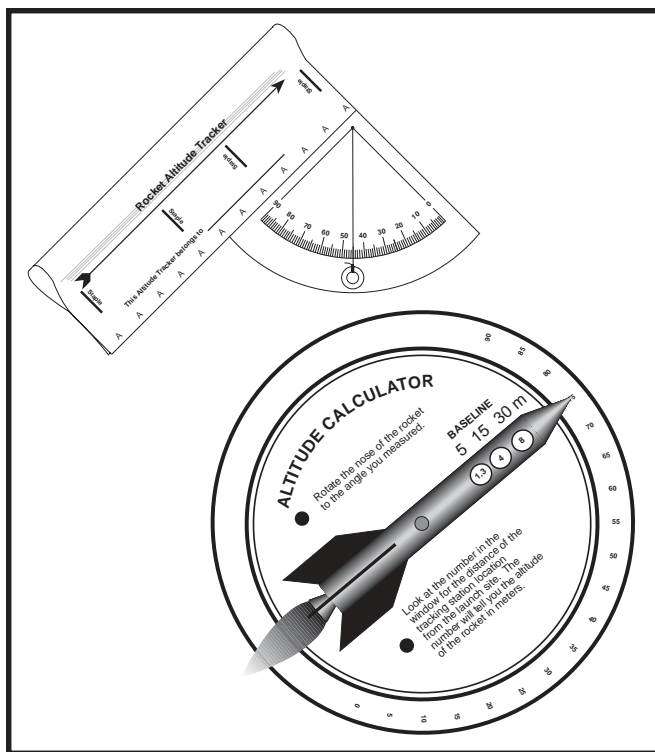

Educator Information

Altitude Tracking

Objective:

To estimate the altitude a rocket achieves during flight.

Description:

In this activity, students construct simple altitude tracking devices for determining the altitude a rocket reaches in its flight.

then input into the altitude tracker calculator and the altitude is read. Roles are reversed so that everyone gets to launch and to track. Depending upon the number of launches held and whether or not every student makes their own Altitude

Trackers and Altitude Calculators, the activity should take about an hour or two. While waiting to launch rockets or track them, students can work on other projects.

Altitude tracking, as used in this activity, can be used with the *Paper Rockets* (page 61), *3-2-1 Pop!* (page 53), and *Bottle Rockets* (page 91) activities and with commercial model rockets. The Altitude Calculator is calibrated for 5, 15, and

Science Standards:

Physical Science - Position and motion of objects
 Science and Technology - Abilities of technological design
 Science and Technology - Understanding about science and technology

Science Process Skills:

Observing
 Measuring
 Collecting Data
 Interpreting Data

Mathematics Standards:

Mathematics as Communication
 Mathematics as Reasoning
 Mathematical Connections
 Estimation
 Number Sense and Numeration
 Geometry and Spatial Sense
 Measurement
 Trigonometry

Management:

Determining the altitude a rocket reaches in flight is a team activity. While one group of students prepares and launches a rocket, a second group measures the altitude the rocket reaches by estimating the angle of the rocket at its highest point from the tracking station. The angle is

Materials and Tools:

- Altitude tracker pattern
- Altitude calculator pattern
- Thread or lightweight string
- Small washer
- Brass paper fastener
- Scissors
- Razor blade knife and cutting surface
- Stapler
- Meter stick
- Rocket and launcher



30 meter baselines. Use the 5-meter baseline for *Paper Rockets* and *3-2-1 Pop!* rockets. Use the 15-meter baseline for *Project X-35*, and use the 30-meter baseline for launching commercial model rockets.

For practical reasons, the Altitude Calculator is designed for angles in increments of 5 degrees. Younger children, may have difficulty in obtaining precise angle measurements with the Altitude Tracker. For simplicity's sake, round measurements off to the nearest 5 degree increment and read the altitude reached directly from the Altitude Calculator. If desired, you can determine altitudes for angles in between the increments by adding the altitudes above and below the angle and dividing by 2. A more precise method for determining altitudes appears later in the procedures.

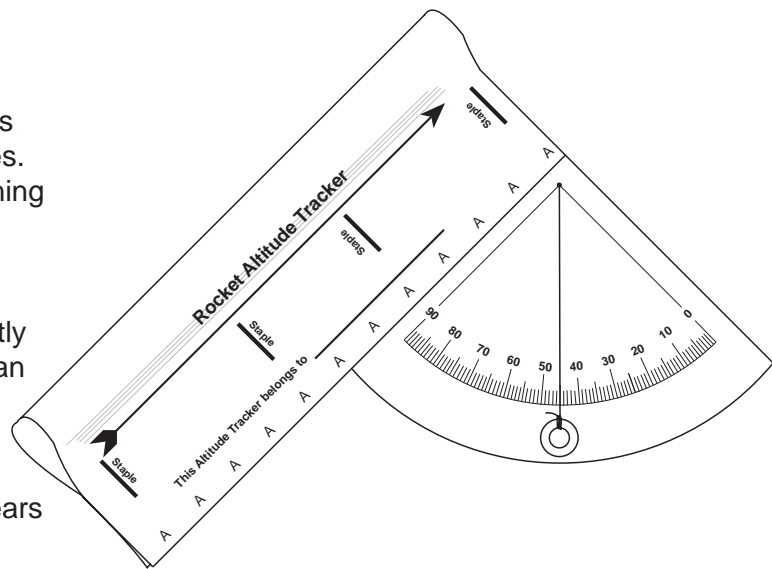

Completed Altitude Tracker Scope

A teacher aid or older student should cut out the three windows in in the Altitude Calculator. A sharp knife or razor and a cutting surface works best for cutting out windows. The altitude tracker is simple enough for everyone to make their own, but they can also be shared. ★Students should practice taking angle measurements and using the calculator on objects of known height such as a building or a flagpole before calculating rocket altitude.

Background Information:

This activity makes use of simple trigonometry to determine the altitude a rocket reaches in flight. The basic assumption of the activity is that the rocket travels straight up from the launch site. If the rocket flies away at an angle other than 90 degrees, the accuracy of the procedure diminishes. For example, if the rocket climbs over a tracking station, where the angle is measured, the altitude calculation will yield an answer higher than the actual altitude reached. On the other hand, if the rocket flies away from the station, the altitude measurement will be lower than the actual value. Tracking accuracy can be increased, by using more than one tracking station to measure the rocket's altitude. Position a second or third station in different directions from the first station. Averaging the altitude measurements will reduce individual error.

Procedure:

Constructing the Altitude Tracker Scope

1. Copy the pattern for the altitude tracker on heavy weight paper.
2. Cut out the pattern on the dark outside lines.
3. Curl (do not fold) the B edge of the pattern to the back until it lines up with the A edge.
4. Staple the edges together where marked. If done correctly, the As and Bs will be on the outside of the tracker.
5. Punch a small hole through the apex of the protractor quadrant on the pattern.
6. Slip a thread or lightweight string through the hole. Knot the thread or string on the back side.
6. Complete the tracker by hanging a small washer from the other end of the thread as shown in the diagram above.



Procedure:
Using the Altitude Tracker

1. Set up a tracking station location a short distance away from the rocket launch site. Depending upon the expected altitude of the

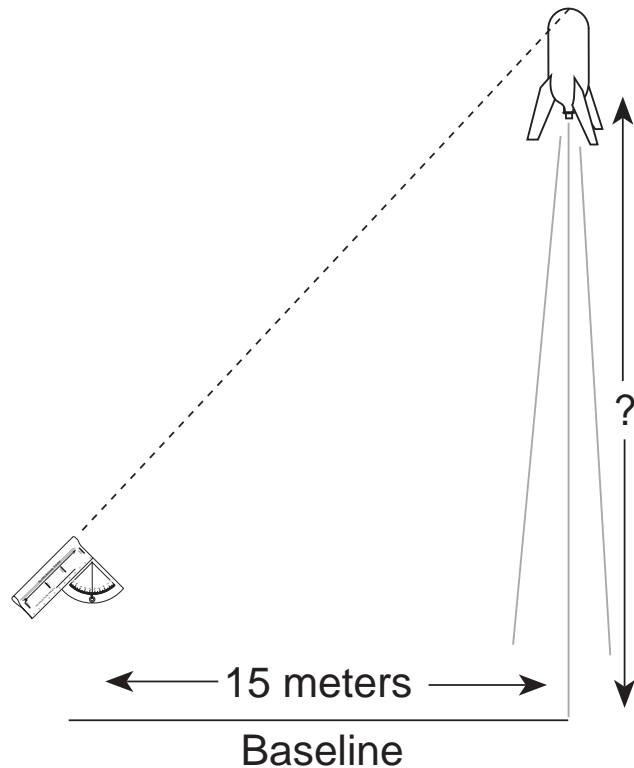

rocket, the tracking station should be 5, 15, or 30 meters away. (Generally, a 5-meter distance is sufficient for paper rockets and antacid-power rockets. A 15-meter distance is sufficient for bottle rockets, and a 30-meter distance is sufficient for model rockets.

2. As a rocket launches, the person doing the tracking will follow the flight with the sighting tube on the tracker. The tracker should be held like a pistol and kept at the same level as the rocket when it is launched. Continue to aim the tracker at the highest point the rocket reached in the sky. Have a second student read the angle the thread or string makes with the quadrant protractor. Record the angle.

Procedure:
Constructing the Altitude Calculator

1. Copy the two patterns for the altitude calculator onto heavy weight paper or glue the patterns on to light weight posterboard. Cut out the patterns.
2. Place the top pattern on a cutting surface and cut out the three windows.
3. Join the two patterns together where the center marks are located. Use a brass paper fastener to hold the pieces together. The pieces should rotate smoothly.

Procedure:
Determining the Altitude

1. Use the Altitude Calculator to determine the height the rocket reached. To do so, rotate the inner wheel of the calculator so that the nose of the rocket pointer is aimed at the angle measured in step 2 of the previous procedure.
2. Read the altitude of the rocket by looking in the window. If you use a 5-meter baseline, the altitude the rocket reached will be in the window beneath the 5. To achieve a more accurate measure, add the height of the person holding the tracker to calculate altitude. If the angle falls between two degree marks, average the altitude numbers above and below the marks.

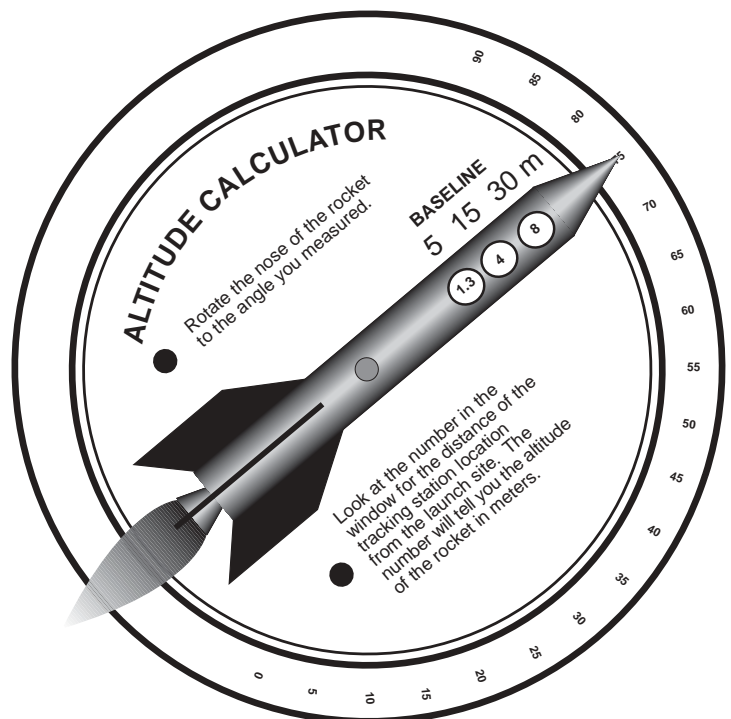

Advanced Altitude Tracking:

1. A more advanced altitude tracking scope can be constructed by replacing the rolled sighting tube with a fat milkshake straw. Use white glue to attach the straw along the 90 degree line of the protractor.
2. Once you determine the angle of the rocket, use the following equation to calculate altitude of the rocket:

$$\text{Altitude} = \tan \angle x \text{ baseline}$$

Use a calculator with trigonometry functions to solve the problem or refer to the tangent table on page 86. For example, if the measured angle is 28 degrees and the baseline is 15 meters, the altitude is 7.97 meters.

$$\text{Altitude} = \tan 28^\circ \times 15 \text{ m}$$

$$\text{Altitude} = 0.5317 \times 15 \text{ m} = 7.97 \text{ m}$$

3. An additional improvement in accuracy can be obtained by using two tracking stations. Averaging the calculated altitude from the two stations will achieve greater accuracy. See the figure below.

Have students demonstrate their proficiency with altitude tracking by sighting on a fixed object of known height and comparing their results. If employing two tracking stations, compare measurements from both stations.

Extensions:

- Why should the height of the person holding the tracker be added to the measurement of the rocket's altitude?
- Curriculum guides for model rocketry (available from model rocket supply companies) provide instructions for more sophisticated rocket tracking measurements. These activities involve two-station tracking with altitude and compass direction measurement and trigonometric functions.

Assessment:

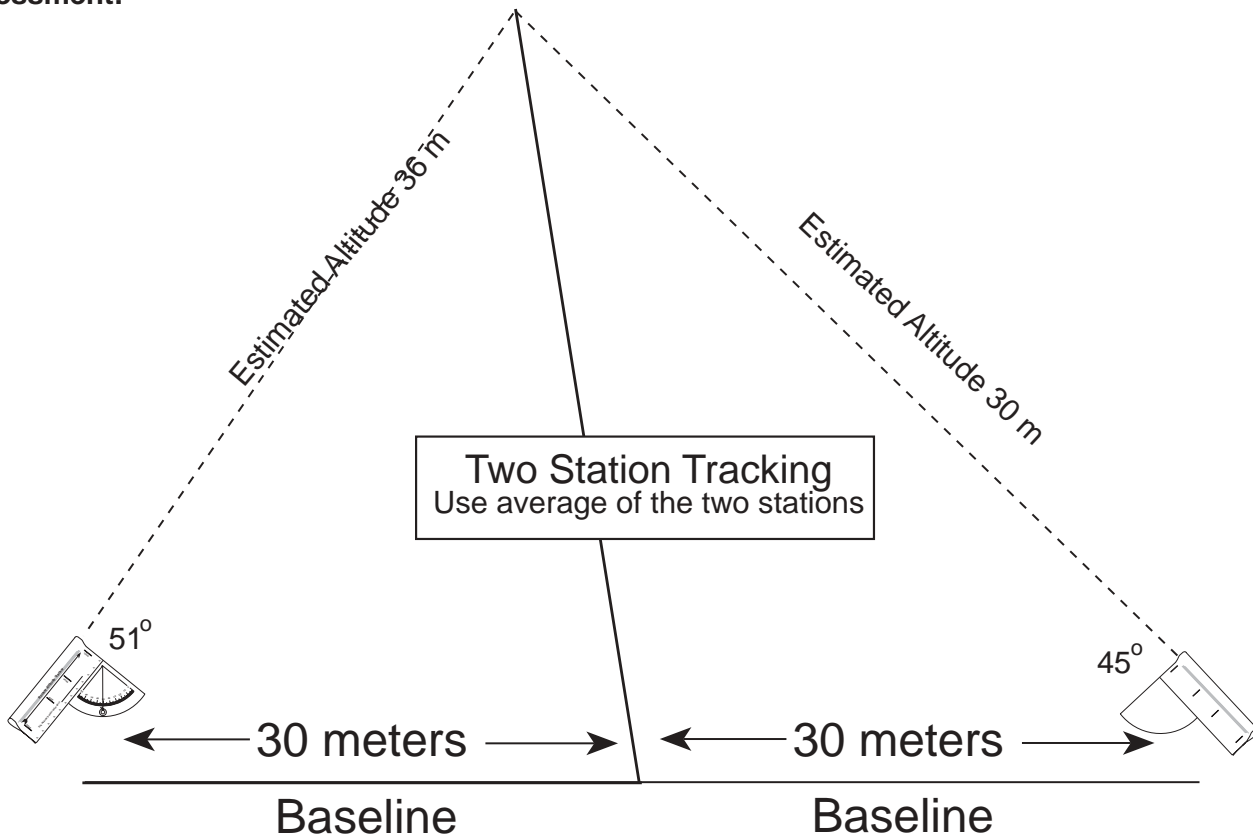

B B B B B B B B B B B B B B B

1. Follow rocket by sighting through tube.
2. Read angle of string for highest altitude of rocket.

Rocket Sighting Instructions:

Rocket Altitude Tracker



This Altitude Tracker belongs to _____

A A A A A A A A A A A A A

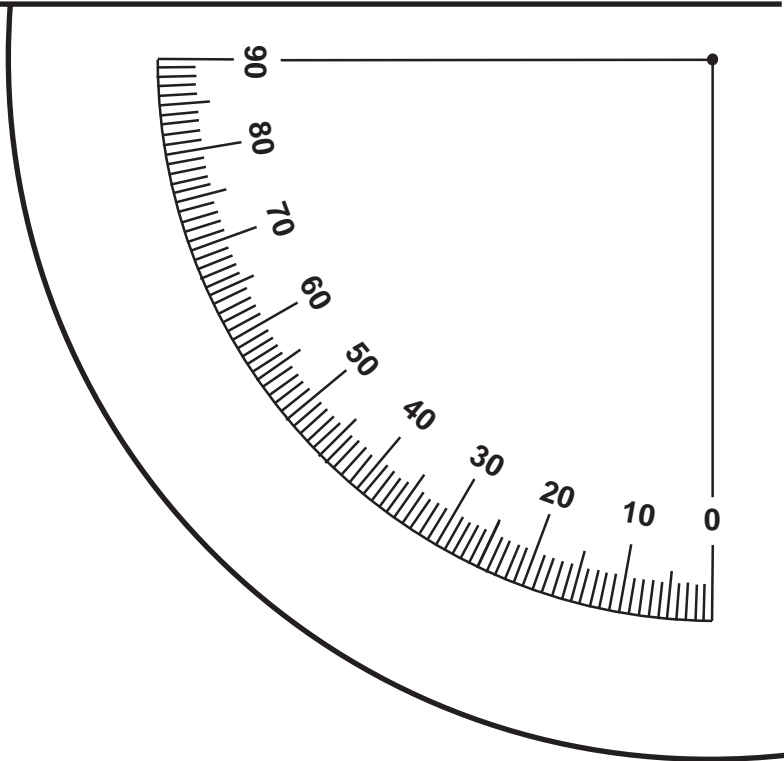

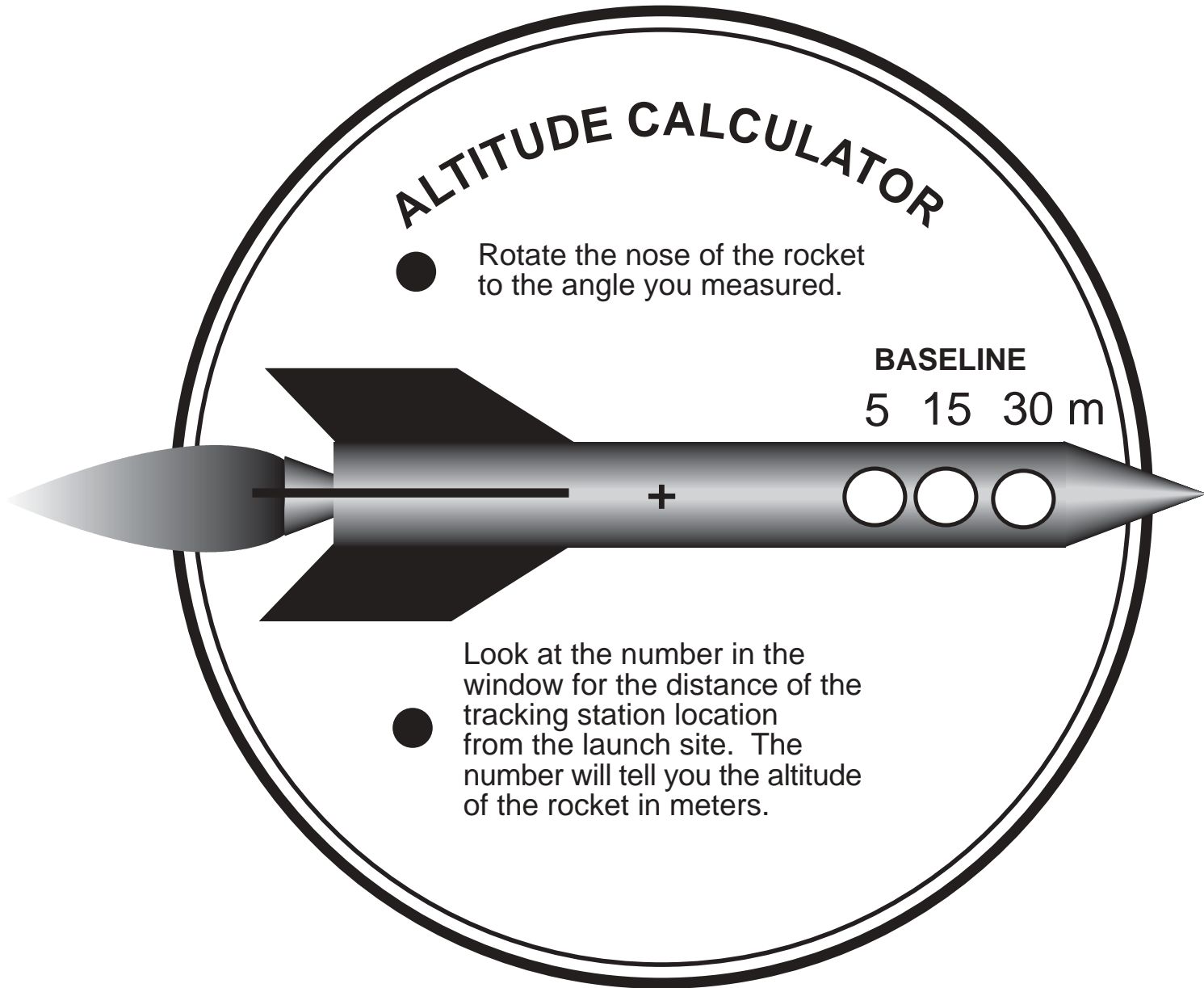

ALTITUDE CALCULATOR - BACK WHEEL

+

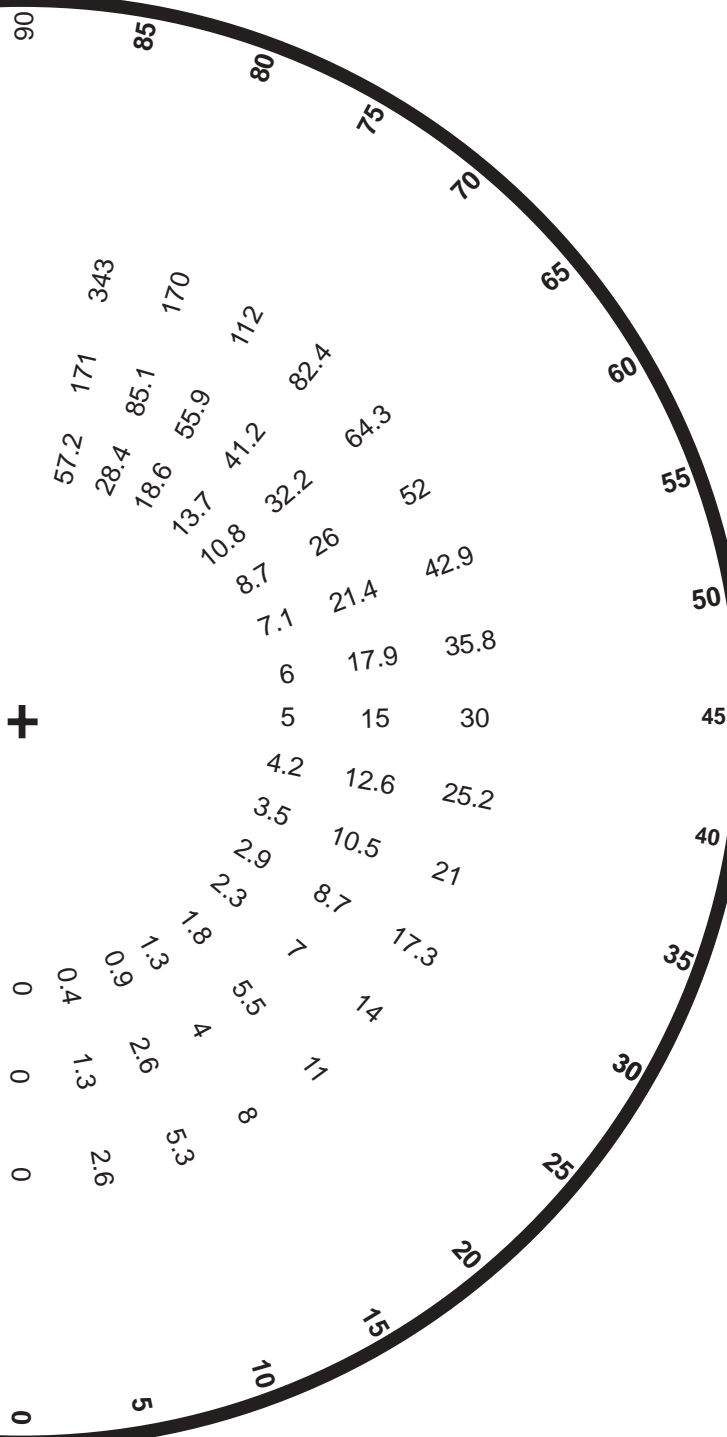

Tangent Table

Degree	Tan	Degree	Tan	Degree	Tan
0	0.0000				
1	0.0174	31	0.6008	61	1.8040
2	0.0349	32	0.6248	62	1.8807
3	0.0524	33	0.6494	63	1.9626
4	0.0699	34	0.6745	64	2.0603
5	0.0874	35	0.7002	65	2.1445
6	0.1051	36	0.7265	66	2.2460
7	0.1227	37	0.7535	67	2.3558
8	0.1405	38	0.7812	68	2.4750
9	0.1583	39	0.8097	69	2.6050
10	0.1763	40	0.8390	70	2.7474
11	0.1943	41	0.8692	71	2.9042
12	0.2125	42	0.9004	72	3.0776
13	0.2308	43	0.9325	73	3.2708
14	0.2493	44	0.9656	74	3.4874
15	0.2679	45	1.0000	75	3.7320
16	0.2867	46	1.0355	76	4.0107
17	0.3057	47	1.0723	77	4.3314
18	0.3249	48	1.1106	78	4.7046
19	0.3443	49	1.1503	79	5.1445
20	0.3639	50	1.1917	80	5.6712
21	0.3838	51	1.2348	81	6.3137
22	0.4040	52	1.2799	82	7.1153
23	0.4244	53	1.3270	83	8.1443
24	0.4452	54	1.3763	84	9.5143
25	0.4663	55	1.4281	85	11.4300
26	0.4877	56	1.4825	86	14.3006
27	0.5095	57	1.5398	87	19.0811
28	0.5317	58	1.6003	88	28.6362
29	0.5543	59	1.6642	89	57.2899
30	0.5773	60	1.7320	90	-----



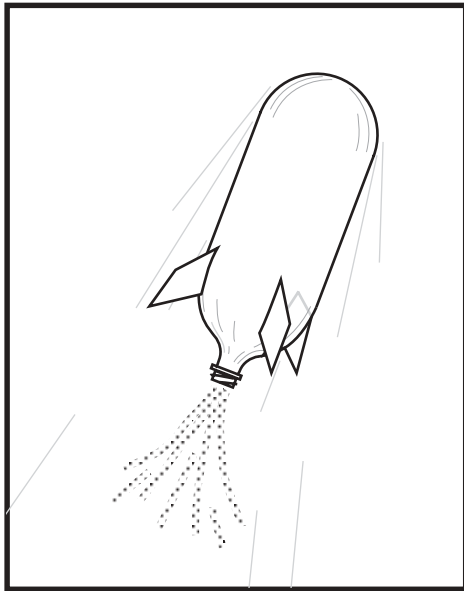

Educator Information

Bottle Rocket Launcher

Objective:

To construct a bottle rocket launcher for use with the *Bottle Rocket* and *Project X-35* activities.

Description:

Students construct a bottle launcher from "off-the-shelf" hardware and wood using simple tools.

Science Standards:

Physical Science - Position and motion of objects
Science and Technology - Abilities of technological design

Science Process Skills:

Measuring

Mathematics Standards:

Mathematical Connections
Measurement

Management:

Consult the materials and tools list to determine what you will need to construct a single bottle rocket launcher. The launcher is simple and inexpensive to construct. Air pressure is provided by means of a hand-operated bicycle pump. The pump should have a pressure gauge for accurate comparisons between launches. Most needed parts are available from hardware stores. In addition you will need a tire valve from an auto parts store and a rubber bottle stopper from a school science experiment. The most difficult task is to drill a 3/8 inch hole in the mending plate called for in the materials list. Electric drills are a common household tool. If you do not have access to one, or do not wish to drill the holes in the metal mending plate, find someone who can do the job for you. Ask a teacher or student in your school's industrial arts shop,

Materials and Tools:

- * 4 5-inch corner irons with 12 3/4 inch wood screws to fit
- * 1 5-inch mounting plate
- * 2 6-inch spikes
- * 2 10-inch spikes or metal tent stakes
- * 2 5-inch by 1/4 inch carriage bolts with six 1/4 inch nuts
- * 1 3-inch eyebolt with two nuts and washers
- * 4 3/4-inch diameter washers to fit bolts
- * 1 Number 3 rubber stopper with a single hole
- * 1 Snap-in Tubeless Tire Valve (small 0.453 inch hole, 2 inch long)
- * Wood board 12 by 18 by 3/4 inches
- * 1 2-liter plastic bottle
- * Electric drill and bits including a 3/8 inch bit
- * Screw driver
- * Pliers or open-end wrench to fit nuts
- * Vice
- * 12 feet of 1/4 inch cord
- * Pencil
- Bicycle pump with pressure gauge

a fellow teacher, or the parent of one of your students to help.

If you have each student construct a bottle rocket, having more than one launcher may be advisable. Because the rockets are projectiles, safely using more than one launcher will require careful planning and possibly additional supervision. Please refer to the launch safety instructions.



Background Information:

Like a balloon, air pressurizes the bottle rocket. When released from the launch platform, air escapes the bottle, providing an action force accompanied by an equal and opposite reaction force (Newton's Third Law of Motion). Increasing the pressure inside the bottle rocket produces greater thrust since a large quantity of air inside the bottle escapes with a higher acceleration (Newton's Second Law of Motion). Adding a small amount of water to the bottle increases the action force. The water expels from the bottle before the air does, turning the bottle rocket into a bigger version of a water rocket toy available in toy stores.

Construction Instructions:

1. Prepare the rubber stopper by enlarging the hole with a drill. Grip the stopper lightly with a vice and gently enlarge the hole with a 3/8 inch bit and electric drill. The rubber will stretch during cutting, making the finished hole somewhat less than 3/8 inches.
2. Remove the stopper from the vice and push the needle valve end of the tire stem through the stopper from the narrow end to the wide end.
3. Prepare the mounting plate by drilling a 3/8 inch hole through the center of the plate. Hold the plate with a vice during

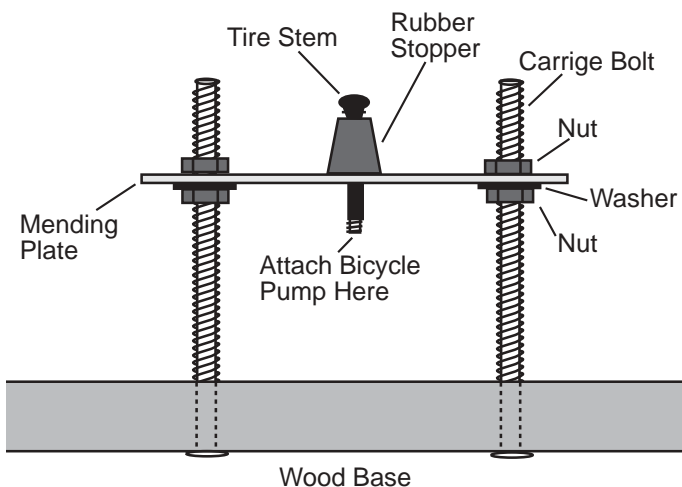

Attachment of Mending Plate and Stopper

drilling and put on eye protection. Enlarge the holes at the opposite ends of the plates, using a drill bit slightly larger than the holes to do this. The holes must be large enough to pass the carriage bolts through them. (See Attachment of Mending Plate and Stopper diagram below.)

4. Lay the mending plate in the center of the wood base and mark the centers of the two outside holes that you enlarged. Drill holes through the wood big enough to pass the carriage bolts through.
5. Push and twist the tire stem into the hole you drilled in the center of the mounting plate. The fat end of the stopper should rest on the plate.

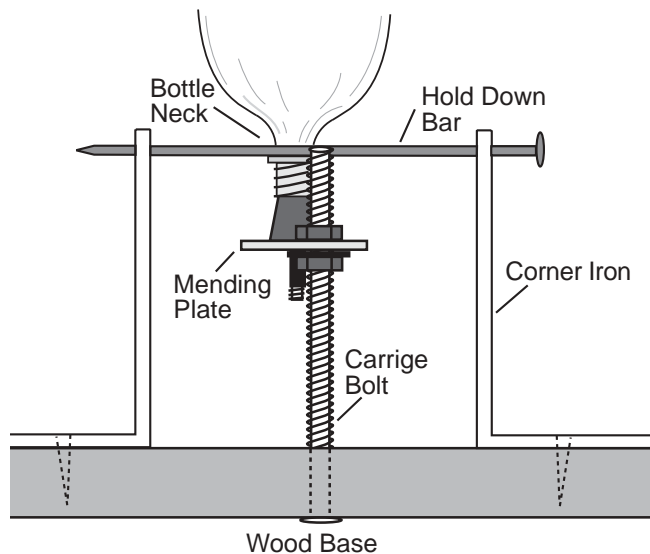

Positioning Corner Irons

6. Insert the carriage bolts through the wood base from the bottom up. Place a hex nut over each bolt and tighten the nut so that the bolt head pulls into the wood.
7. Screw a second nut over each bolt and spin it about half way down the bolt. Place a washer over each nut and then slip the mounting plate over the two bolts.
8. Press the neck of a 2-liter plastic bottle over the stopper. You will be using the bottle's wide neck lip for measuring in the next step.

9. Set up two corner irons so they look like book ends. Insert a spike through the top hole of each iron. Slide the irons near the bottle neck so that the spike rests immediately above the wide neck lip. The spike will hold the bottle in place while you pump up the rocket. If the bottle is too low, adjust the nuts beneath the mounting plate on both sides to raise it.
10. Set up the other two corner irons as you did in the previous step. Place them on the opposite side of the bottle. When you have the irons aligned so that the spikes rest above and hold the bottle lip, mark the centers of the holes on the wood base. For more precise screwing, drill small pilot holes for each screw and then screw the corner irons tightly to the base.
11. Install an eyebolt to the edge of the opposite holes for the hold down spikes. Drill a hole and hold the bolt in place with washers and nuts on top and bottom.
12. Attach the launch "pull cord" to the head end of each spike. Run the cord through the eyebolt.
13. Make final adjustments to the launcher by attaching the pump to the tire stem and pumping up the bottle. Refer to the launching instructions for safety notes. If the air seeps out around the stopper, the stopper is too loose. Use a pair of pliers or a wrench to raise each side of the mounting plate in turn to press the stopper with slightly more force to the bottle neck. When satisfied with the position, thread the remaining hex nuts over the mounting plate and tighten them to hold the plate in position.
14. Drill two holes through the wood base along one side. The holes should be large enough to pass large spikes of metal tent stakes. When the launch pad is set up on a grassy field, the stakes will hold the launcher in place when you yank the pull cord. The launcher is now complete. (See page 90.)

Launch Safety Instructions:

1. Select a grassy field that measures approximately 30 meters across. Place the launcher in the center of the field and anchor it in place with the spikes or tent stakes. (If it is a windy day, place the launcher closer to the side of the field from which the wind is coming so that the rocket will drift on to the field as it comes down.)
2. Have each student or student group set up their rocket on the launch pad. Other students should stand back several meters. It will be easier to keep observers away by roping off the launch site.
3. After the rocket is attached to the launcher, the student pumping the rocket should put on eye protection. The rocket should be pumped no higher than about 50 pounds of pressure per square inch.
4. When pressurization is complete, all students should stand in back of the rope for the countdown.
5. Before conducting the countdown, be sure the place where the rocket is expected to come down is clear of people. Launch the rocket when the recovery range is clear.
6. Only permit the students launching the rocket to retrieve it.

Extensions:

Look up the following references for additional bottle rocket plans and other teaching strategies:

Hawthorne, M. & Saunders, G. (1993), "Its Launchtime!," Science and Children, v30n5, pp.17-19, 39.

Rogis, J. (1991), "Soaring with Aviation Activities," Science Scope, v15n2, pp.14-17.

Winemiller, J., Pedersen, J., & Bonnstetter, R. (1991), "The Rocket Project," Science Scope, v15n2, pp.18-22.



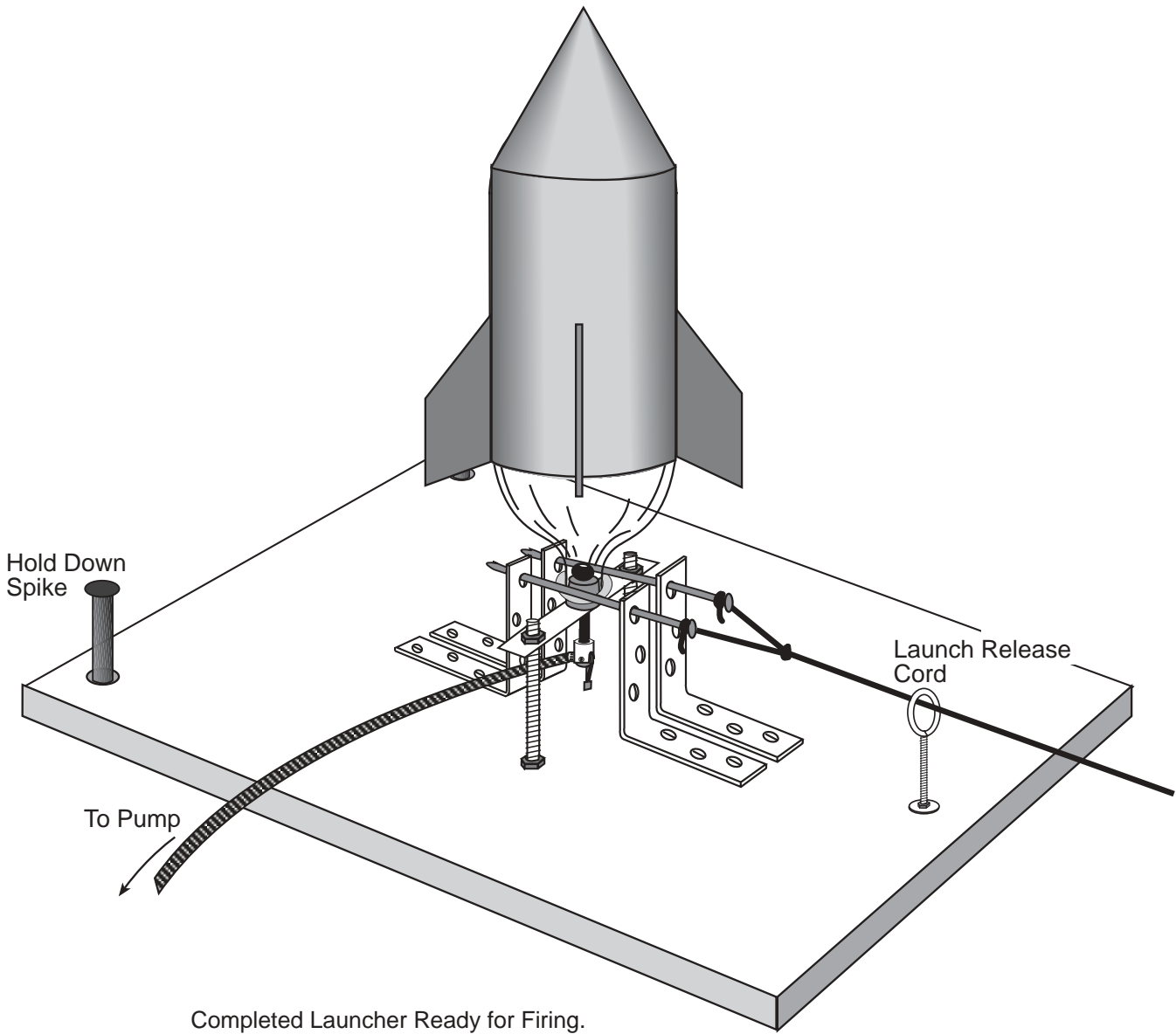

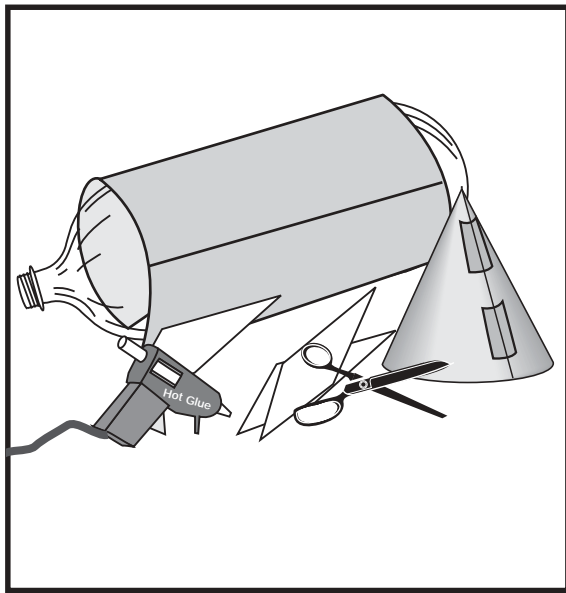

Educator Information

Bottle Rocket

Objective:

To construct and launch a simple bottle rocket.

Description:

Working in teams, learners will construct a simple bottle rocket from 2-liter soft drink bottles and other materials.

Science Standards:

Physical Science - Position and motion of objects
 Science and Technology - Abilities of technological design

Science Process Skills:

Measuring
 Making Models

Mathematics Standards:

Mathematical Connections
 Measurement
 Geometry and Spatial Sense

Materials and Tools:

- 2-liter plastic soft drink bottles
- Low-temperature glue guns
- Poster board
- Tape
- Modeling clay
- Scissors
- Safety Glasses
- Decals
- Stickers
- Marker pens
- Launch pad from the Bottle Rocket Launcher

Management:

This activity can stand alone or be incorporated in the activity *Project X-35* that follows. Having the learners work in teams will reduce the amount of materials required. Begin saving 2-liter bottles several weeks in advance to have a sufficient supply for your class. You will need to have at least one bottle rocket launcher. Construct the launcher described in the previous activity or obtain one from a science or technology education supply catalog.

The simplest way to construct the rockets is to use low-temperature electric glue guns that are available from craft stores. High-temperature glue guns will melt the plastic

bottles. Provide glue guns for each table or set up glue stations in various parts of the room.

Collect a variety of decorative materials before beginning this activity so students can customize their rockets. When the rockets are complete, test fly them. Refer to the *Altitude Tracker* activity starting on page 79 for information on determining how high the rockets fly. While one group of students launches their rocket, have another group track the rocket and determine its altitude.

When launching rockets, it is important for the other students to stand back.



Countdowns help everybody to know when the rocket will lift off. In group discussion, have your students create launch safety rules that everybody must follow. Include how far back observers should stand, how many people should prepare the rocket for launch, who should retrieve the rocket, etc.

Background Information:

Bottle rockets are excellent devices for investigating Newton's Three Laws of Motion. The rocket will remain on the launch pad until an unbalanced force is exerted propelling the rocket upward (First Law). The amount of force depends upon how much air you pumped inside the rocket (Second Law). You can increase the force further by adding a small amount of water to the rocket. This increases the mass the rocket expels by the air pressure. Finally, the action force of the air (and water) as it rushes out the nozzle creates an equal and opposite reaction force propelling the rocket upward (Third Law).

The fourth instruction on the Student Page asks the students to press modeling clay into the nose cone of the rocket. Placing 50 to 100 grams of clay into the cone helps to stabilize the rocket by moving the center of mass farther from the center of pressure. For a complete explanation of how this works, see pages 21-22.

Procedures:

Refer to the Student Page for procedures and optional directions for making paper helicopters. See the extension section below for details on how to use the helicopters.

Assessment:

Evaluate each bottle rocket on its quality of construction. Observe how well fins align and attach to the bottle. Also observe how straight the nose cone is at the top of the rocket. If you choose to measure how high

the rockets fly, compare the altitude the rockets reach with their design and quality of the construction.

Extensions:

- Challenge rocket teams to invent a way to attach a parachute to the rocket that will deploy on the rocket's way back down.
- Parachutes for bottle rockets can be made from a plastic bag and string. The nose cone is merely placed over the rocket and parachute for launch. The cone needs to fit properly for launch or it will slip off. The modeling clay in the cone will cause the cone to fall off, deploying the parachute or paper helicopters, after the rocket tilts over at the top of its flight.
- Extend the poster board tube above the rounded end of the bottle. This will make a payload compartment for lofting various items with the rocket. Payloads might include streamers or paper helicopters that will spill out when the rocket reaches the top of its flight. Copy and distribute the page on how to make paper helicopters. Ask the students to identify other possible payloads for the rocket. If students suggest launching small animals with their rockets, discuss the purpose of flying animals and the possible dangers if they are actually flown.
- Conduct flight experiments by varying the amount of air pressure and water to the rocket before launch. Have the students develop experimental test procedures and control for variables.
- Conduct spectacular nighttime launches of bottle rockets. Make the rockets visible in flight by taping a small-size chemical light stick near the nose cone of each rocket. Light sticks are available at toy and camping stores and can be used for many flights. This is an especially good activity for summer "space camp" programs.



Building A Bottle Rocket

1. Wrap and glue or tape a tube of posterboard around the bottle.

2. Cut out several fins of any shape and glue them to the tube.

3. Form a nosecone and hold it together with tape or glue.

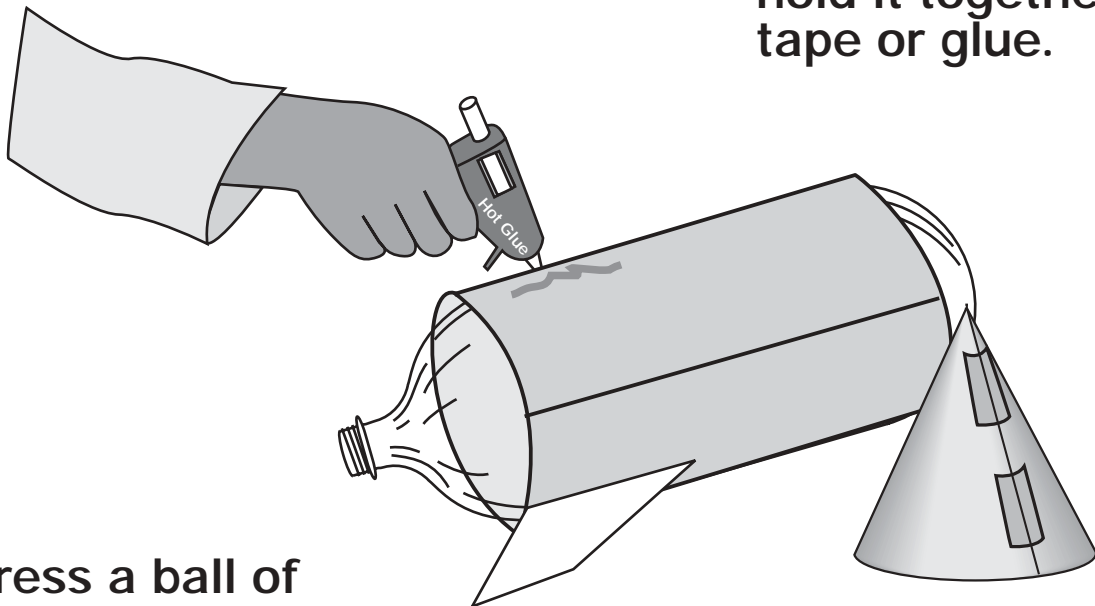

4. Press a ball of modeling clay into the top of the nosecone.

5. Glue or tape nosecone to upper end of bottle.

6. Decorate your rocket.



Paper Helicopter Plans

1. Cut on solid black lines.
Fold on dashed lines.

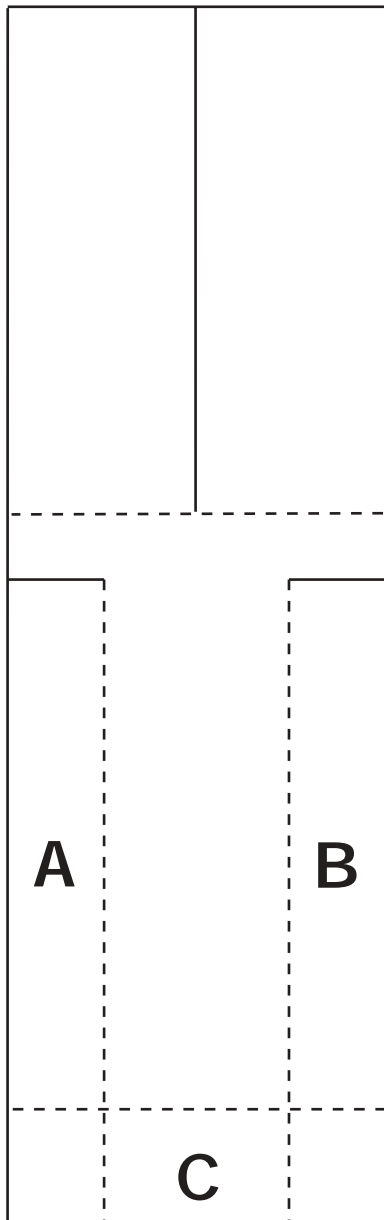

Paper Helicopter
Pattern

2. Fold A and B
to middle.

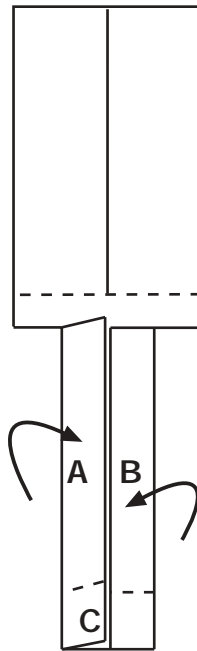

3. Fold C up.

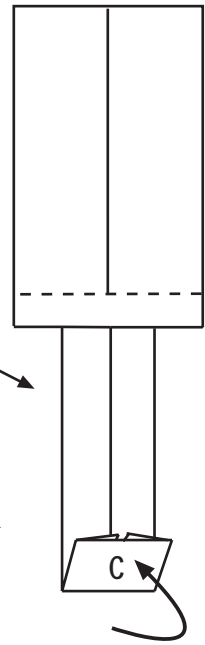

4. Fold propeller blades
outward.

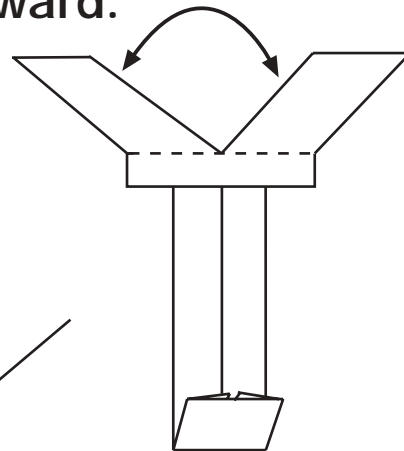

5. Test fly by dropping
from over your head.



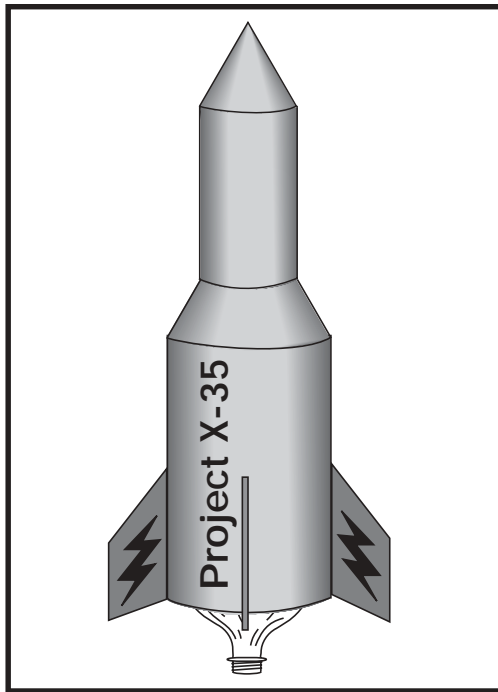

Educator Information

Project X-35

Objective:

To demonstrate rocketry principles through a cooperative, problem solving simulation.

Description:

Teams simulate the development of a commercial proposal to design, build, and launch a rocket.

Science Standards:

Science as Inquiry
 Physical Science - Position and motion of objects
 Science and Technology - Abilities of technological design
 Science in Personal and Social Perspectives -
 Science and technology in local challenges

Science Process Skills:

Observing
 Communicating
 Measuring
 Collecting Data
 Inferring
 Predicting
 Making Models
 Interpreting Data
 Controlling Variables
 Defining Operationally
 Investigating

Mathematics Standards:

Mathematics as Problem Solving
 Mathematics as Communication
 Mathematical Connections
 Estimation
 Number Sense and Numeration
 Whole Number Computation
 Geometry and Spatial Sense
 Measurement
 Fractions and Decimals
 Functions

Materials and Tools:

(All supplies need to be available per group)

- 2 liter soda bottles
- 1 liter soda bottles
- Film canisters
- Aluminium soda cans
- Scrap cardboard and poster board
- Large cardboard panels
- Duct Tape
- Electrical tape
- Glue sticks
- Low-temperature glue gun
- Water
- Clay
- Plastic garbage bags
- Crepe paper
- String
- Paint
- Safety glasses
- Bottle Rocket Launcher (See page 87.)
- Altitude Calculator (See page 79.)

Management:

Prior to this project students should have the opportunity to design, construct, and launch a bottle rocket evaluating various water volumes and air pressures and calculating the altitude traveled by these rockets. See *Bottle Rocket* page 91 and *Altitude Tracking* page 79.

This project is designed to offer students an opportunity to participate in an



interdisciplinary approach to life skills. Students work in teams of threes. Each member has designated tasks for their specific job title to help the team function effectively. These include: Project Manager, Budget Director, and Design and Launch Director. The student section provides badges and tasks.

The project takes approximately two weeks to complete and includes a daily schedule of tasks. Students may need additional time to complete daily tasks.

Collect all building materials and copy all reproducibles before beginning the activity. Be sure to make several copies of the order forms and checks for each group.

Allow enough time on the first day for the students to read and discuss all sheets and determine how they apply to the project schedule. Focus on the student score sheet to allow a clear understanding of the criteria used for assessment of the project.

Background Information:

This project provides students with an exciting activity to discover practical demonstrations of force and motion in actual experiments while dealing with budgetary restraints and deadlines reflected in real life situations.

The students should have a clear understanding of rocket principles dealing with Newton's Laws of Motion found on page 13 and Practical Rocketry found on page 18 before beginning this project.

Procedure:

Refer to the student sheets. The events for day 3 and day 6 call for teacher demonstrations on how to make nose cones and how to determine the center of mass and the center of pressure.

Assessment:

Assessment will be based on documentation of three designated areas: each group's project journal, silhouette, and launch results. See Student Score Sheet for details.

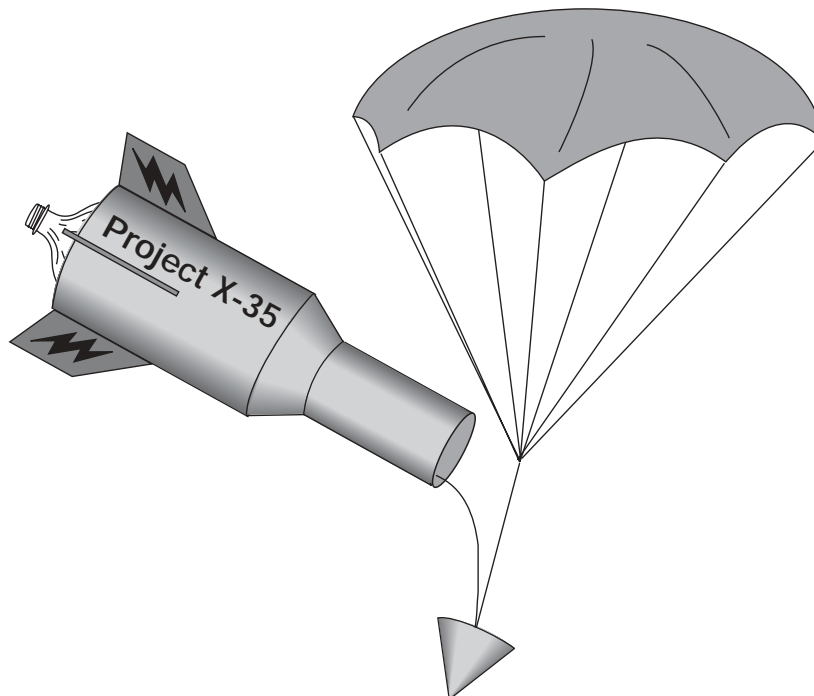

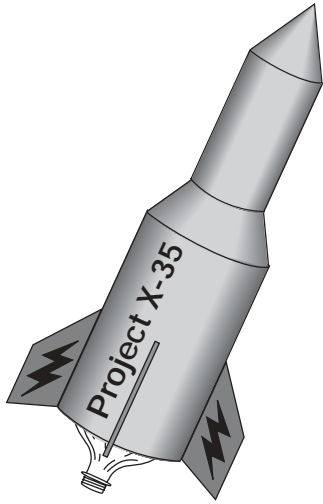

Request For Proposals

The United Space Authority (USA) is seeking competitive bids for a new advanced rocket launch vehicle that will reduce the costs of launching payloads into Earth orbit. Interested companies are invited to submit proposals to USA for designing and building a rocket that will meet the following criteria.

The objectives of Project X-35 are:

- a. Design and draw a bottle rocket plan to scale (1 square = 2 cm).
- b. Develop a budget for the project and stay within the budget allowed.
- c. Build a test rocket using the budget and plans developed by your team.
- d. Identify rocket specifications and evaluate rocket stability by determining center of mass and center of pressure and conducting a swing test.
- e. Display fully illustrated rocket design in class. Include: dimensional information, location of center of mass, center of pressure, and flight information such as time aloft and altitude reached.
- f. Successfully test launch rocket achieving maximum vertical distance and accuracy.
- g. Successfully and accurately complete rocket journal.
- h. Develop a cost analysis and demonstrate the most economically efficient launch.

Proposal Deadline:

Two (2) weeks



Project Schedule

Project X-35 Schedule

Day 1

- Form rocket companies.
- Brainstorm ideas for design and budget.
- Sketch preliminary rocket design.

Project X-35 Schedule

Day 2

- Develop materials and budget list.
- Develop scale drawing.

Project X-35 Schedule

Day 3

- Demonstration: nose cone construction.
- Issue materials and begin construction.

Project X-35 Schedule

Day 4

- Continue construction.

Project X-35 Schedule

Day 5

- Complete construction.

Project X-35 Schedule

Day 6

- Demonstration: Find center of mass and center of pressure.
- Introduce rocket silhouette construction and begin rocket analysis.

Project X-35 Schedule

Day 7

- Finish silhouette construction and complete prelaunch analysis. Hang silhouette.
- Perform swing test.

Project X-35 Schedule

Day 8

- Launch Day!

Project X-35 Schedule

Day 9

- Complete post launch results, silhouette documentation.
- Prepare journal for collection.
- Documentation and journal due at beginning of class tomorrow.



Project X-35 Checklist

Project Grading:

50% Documentation: See Project Journal below. Must be complete, neat, accurate, and on time.

25% Proper display and documentation of rocket silhouette.

25% Launch data: Measurements, accuracy, and completeness.

Project Awards:

USA will award exploration contracts to the companies with the top three rockets designs based on the above criteria. The awards are valued at:

First - \$ 10,000,000

Second - \$ 5,000,000

Third - \$ 3,000,000

Project Journal: Check off items as you complete them.

1. Creative cover with member's names, date, project number, and company name.
2. Certificate of Assumed Name (Name of your business).
3. Scale drawing of rocket plans. Clearly indicate scale. Label: Top, Side, and End View.
4. Budget Projection.
5. Balance Sheet.
6. Canceled checks, staple or tape checks in ascending numerical order, four to a sheet of paper.
7. Pre-Launch Analysis.
8. Rocket Launch Day Log.
9. Score Sheet (Part 3).



Badges

Each group member will be assigned specific tasks to help their team function successfully. All team members assist with design, construction, launch, and paper work. Enlarge the badges and glue them front and back to poster board. Cut out the slot and attach a string.

X-35 Project Manager

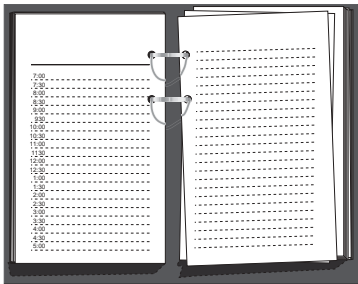

Oversees the project. Keeps others on task. Only person who can communicate with teacher.

- Arrange all canceled checks in ascending numerical order. Make a neat copy of the team's Rocket Journal.
- Use appropriate labels as necessary.
- Check over balance sheet. List all materials used in rocket construction.
- Complete silhouette information and display properly in room.
- Assist other team members as needed.

X-35 Design and Launch Director

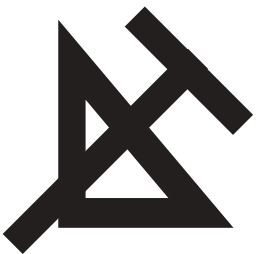

Supervises design and construction of rocket. Directs others during launch.

- Make a neat copy of the Launch Day Log.
- Use appropriate labels as necessary.
- Arrange to have a creative cover made.
- Assist other team members as needed.

X-35 Budget Director



Keeps accurate account of money and expenses and pays bills. Must sign all checks.

- Arrange all canceled checks in order and staple four to a sheet of paper.
- Check over budget projection sheet. Be sure to show total project cost estimates.
- Check over balance sheet. Be sure columns are complete and indicate a positive or negative balance.
- Complete part 3 of the score sheet.
- Assist other team members as needed.

Badge Front

Badge Back



State of _____

Certificate of Assumed Name

All Information on this form is public information.
Please type or print legibly in black ink.

Project Number _____

1. State the exact assumed name under which the business is or will be conducted:

2. List the name and title of all persons conducting business under the above assumed name:

Today's Date _____, 19 ____ Class Hour _____

Filling Fee: a \$25 fee must accompany this form.



Project X-35 Budget

Each team will be given a budget of \$1,000,000. Use money wisely and keep accurate records of all expenditures. Once your money runs out, you will operate in the "red" and this will count against your team score. If you are broke at the time of launch, you will be unable to purchase rocket fuel. You will then be forced to launch only with compressed air. You may only purchase as much rocket fuel as you can afford at the time of launch.

All materials not purchased from listed subcontractors will be assessed an import duty tax, 20% of the market value. Materials not on the subcontractors list will be assessed an Originality Tax of \$5,000.00 per item.

A project delay penalty fee will be assessed for not working, lacking materials, etc. This penalty fee could be as high as \$300,000 per day.

Approved Subcontractor List

SubContractor		Market Price
Bottle Engine Corporation		
	2 L bottle	\$ 200,000
	1 L bottle	\$ 150,000
Aluminum Cans Ltd.		
	Can	\$ 50,000
International Paper Corporation		
	Cardboard - 1 sheet	\$ 25,000
	Tagboard - 1 sheet	\$ 30,000
	Manila Paper - 1 sheet	\$ 40,000
	Silhouette Panel - 1 sheet	\$ 100,000
International Tape and Glue Company		
	Duct Tape - 50 cm segments	\$ 50,000
	Electrical Tape - 100 cm segments	\$ 50,000
	Glue Stick	\$ 20,000
Aqua Rocket Fuel Service		
	1 ml	\$ 300
Strings, Inc.		
	1 m	\$ 5,000
Plastic Sheet Goods		
	1 bag	\$ 5,000
Common Earth Corporation		
	Modeling Clay - 100 g	\$ 5,000
NASA Launch Port	Launch	\$ 100,000
NASA Consultation	Question	\$ 1,000



Project X-35

Order Form

Company Name: _____

Check No. _____ Budget Director's Signature _____

Date _____ Supply Company Name _____

Item Ordered	Quantity	Unit Cost	Total Cost
		_____	_____

Project X-35

Order Form

Company Name: _____

Check No. _____ Budget Director's Signature _____

Date _____ Supply Company Name _____

Item Ordered	Quantity	Unit Cost	Total Cost
		_____	_____

Project X-35

Order Form

Company Name: _____

Check No. _____ Budget Director's Signature _____

Date _____ Supply Company Name _____

Item Ordered	Quantity	Unit Cost	Total Cost
		_____	_____

Project X-35

Order Form

Company Name: _____

Check No. _____ Budget Director's Signature _____

Date _____ Supply Company Name _____

Item Ordered	Quantity	Unit Cost	Total Cost
		_____	_____



Project X-35 Budget Projection

Company Name _____

Record below all expenses your company expects to incur in the design, construction, and launch of your rocket.

Item	Supplier	Quantity	Unit Cost	Total Cost
			_____.	_____.
			_____.	_____.
			_____.	_____.
			_____.	_____.
			_____.	_____.
			_____.	_____.
			_____.	_____.
			_____.	_____.
			_____.	_____.
			_____.	_____.
			_____.	_____.
			_____.	_____.
Projected Total Cost				_____.



Keep This Stub For Your Records Check No. _____ Date _____, 19____ To _____ _____ For _____ _____ Amount \$ <input type="text"/>	Detach on Dashed Lines	Company Name: _____	Check No. _____
		Pay to the order of _____	Date _____, 19____
		_____	\$ <input type="text"/>
		For _____	_____ Dollars _____
		_____	Authorized Signature _____
		_____	Budget Director's Signature _____

Keep This Stub For Your Records Check No. _____ Date _____, 19____ To _____ _____ For _____ _____ Amount \$ <input type="text"/>	Detach on Dashed Lines	Company Name: _____	Check No. _____
		Pay to the order of _____	Date _____, 19____
		_____	\$ <input type="text"/>
		For _____	_____ Dollars _____
		_____	Authorized Signature _____
		_____	Budget Director's Signature _____

Keep This Stub For Your Records Check No. _____ Date _____, 19____ To _____ _____ For _____ _____ Amount \$ <input type="text"/>	Detach on Dashed Lines	Company Name: _____	Check No. _____
		Pay to the order of _____	Date _____, 19____
		_____	\$ <input type="text"/>
		For _____	_____ Dollars _____
		_____	Authorized Signature _____
		_____	Budget Director's Signature _____

Keep This Stub For Your Records Check No. _____ Date _____, 19____ To _____ _____ For _____ _____ Amount \$ <input type="text"/>	Detach on Dashed Lines	Company Name: _____	Check No. _____
		Pay to the order of _____	Date _____, 19____
		_____	\$ <input type="text"/>
		For _____	_____ Dollars _____
		_____	Authorized Signature _____
		_____	Budget Director's Signature _____



Rocket Measurements For Scale Drawing

Project No. _____
Date _____

Company Name _____

Use metric measurements to measure and record the data in the blanks below. Be sure to accurately measure all objects that are constant (such as the bottles) and those you will control (like the size and design of fins). If additional data lines are needed, use the back of this sheet.

Object	Length	Width	Diameter	Circumference

Using graph paper draw a side, top, and bottom view of your rocket, to scale (1 square = 2 cm), based on the measurements recorded above. Attach your drawings to this paper.



Scale Drawing

1 square = 2 cm

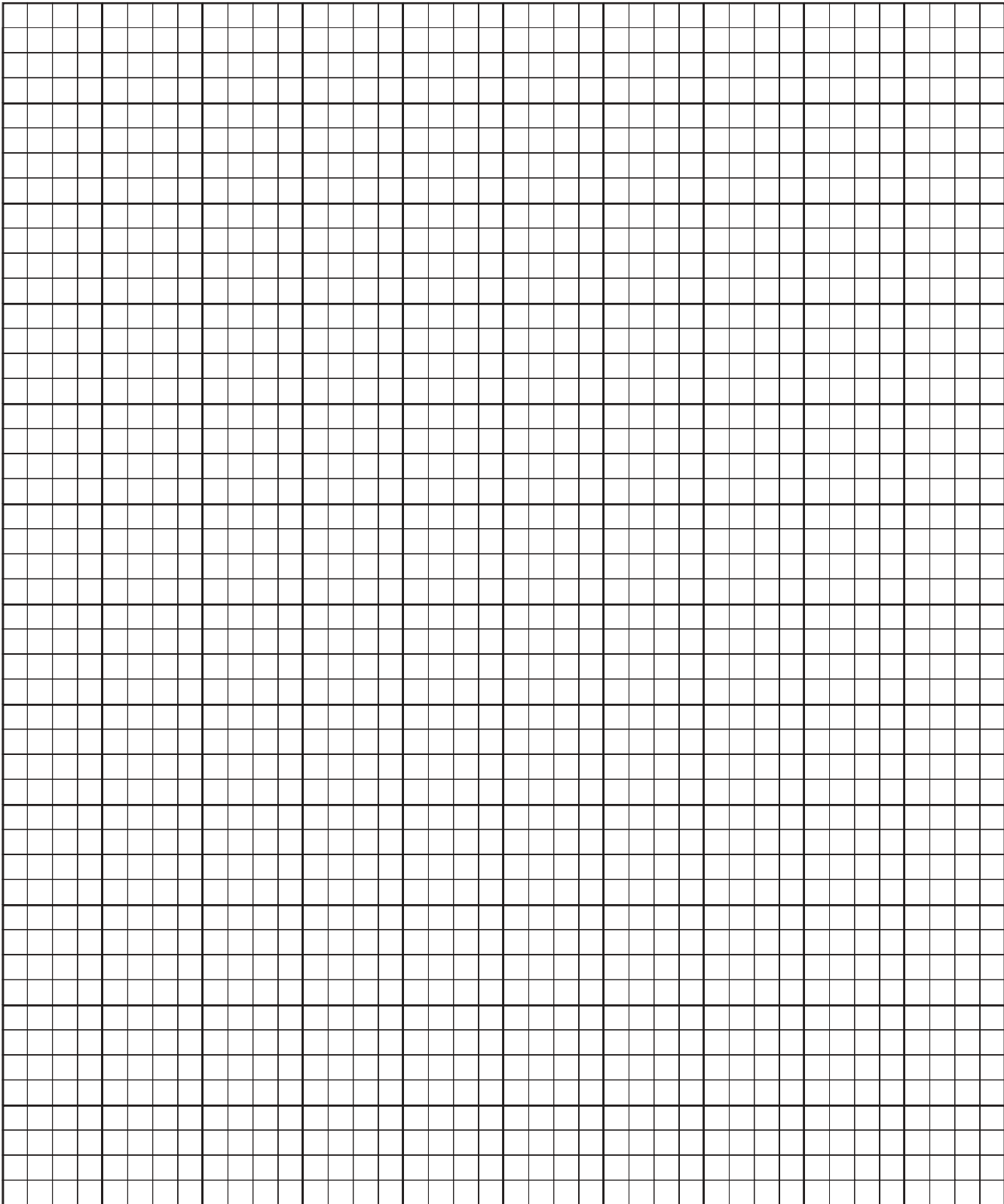

Rocket Stability Determination

A rocket that flies straight through the air is said to be a *stable* rocket. A rocket that veers off course or tumbles wildly is said to be an *unstable* rocket. The difference between the flight of a stable and unstable rocket depends upon its design. All rockets have two distinct "centers." The first is the *center of mass*. This is a point about which the rocket balances. If you could place a ruler edge under this point, the rocket would balance horizontally like a seesaw. What this means is that half of the mass of the rocket is on one side of the ruler edge and half is on the other. Center of mass is important to a rocket's design because if a rocket is unstable, the rocket will tumble about this center.

The other center in a rocket is the *center of pressure*. This is a point where half of the surface area of a rocket is on one side and half is on the other. The center of pressure differs from center of mass in that its location is not affected by the placement of payloads in the rocket. This is just a point based on the surface of the rocket, not what is inside. During flight, the pressure of air rushing past the rocket will balance half on one side of this point and half on the other. You can determine the center of pressure by cutting out an exact silhouette of the rocket from cardboard and balancing it on a ruler edge.

The positioning of the center of mass and the center of pressure on a rocket is critical to its stability. The center of mass should be towards the rocket's nose and the center of pressure should be towards the rocket's tail for the rocket to fly straight. That is because the lower end of the rocket (starting with the center of mass and going downward) has more surface area than the upper end (starting with the center of mass and going upward). When the rocket flies, more air pressure exists on the lower end of the rocket than on the upper end. Air pressure will keep the lower end down and the upper end up. If the center of mass and the center of pressure are in the same place, neither end of the rocket will point upward. The rocket will be unstable and tumble.

Stability Determination Instructions

1. Tie a string loop around the middle of your rocket. Tie a second string to the first so that you can pick it up. Slide the string loop to a position where the rocket balances. You may have to temporarily tape the nose cone in place to keep it from falling off.
2. Draw a straight line across the scale diagram of the rocket you made earlier to show where the ruler's position is. Mark the middle of the line with a dot. This is the rocket's center of mass.
3. Lay your rocket on a piece of cardboard. Carefully trace the rocket on the cardboard and cut it out.

4. Lay the cardboard silhouette you just cut out on the ruler and balance it.
5. Draw a straight line across the diagram of your rocket where the ruler is. Mark the middle of this line with a dot. This is the center of pressure of the rocket.

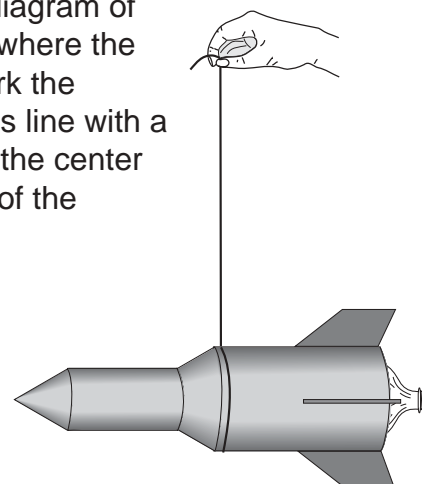

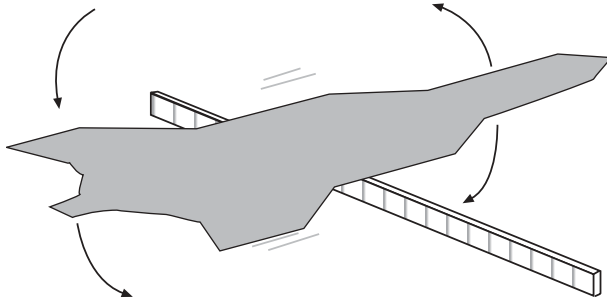

If your center of mass is in front of the center of pressure, your rocket should be stable. Proceed to the swing test. If the two centers are next to or on top of each other, add more clay to the nosecone of the rocket. This will move the center of mass forward. Repeat steps 2 and 3 and then proceed to the swing test.

Swing Test:

1. Tape the string loop you tied around your rocket in the previous set of instructions so that it does not slip.
2. While standing in an open place, slowly begin swinging your rocket in a circle. If the rocket points in the direction you are swinging it, the rocket is stable. If not, add more clay to the rocket nose cone or replace the rocket fins with larger ones. Repeat the stability determination instructions and then repeat the swing test.

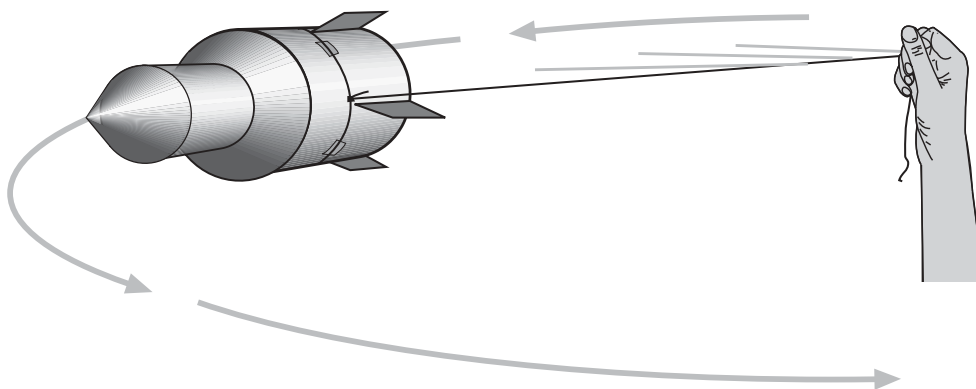
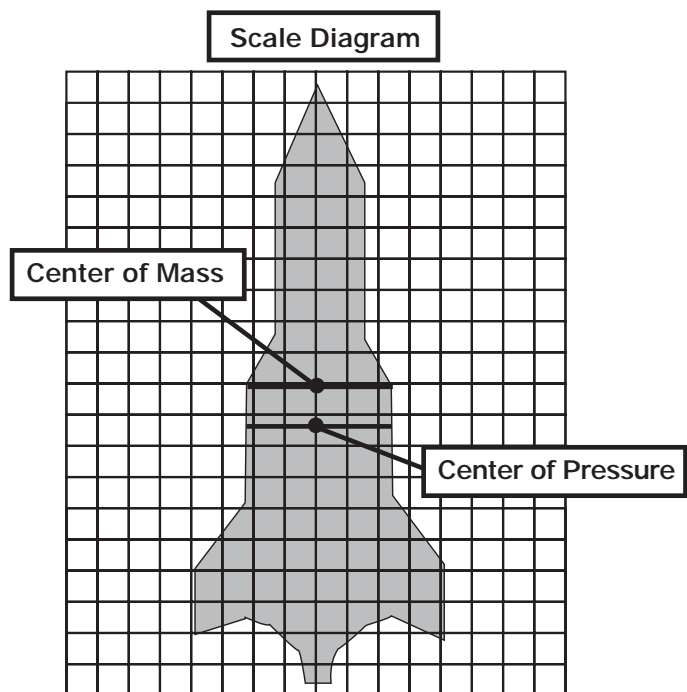

Pre-Launch Analysis

Company Name: _____	Project Number: <input type="text"/>
Employee Name: _____	
Job Title: _____	
Employee Name: _____	
Job Title: _____	
Employee Name: _____	
Job Title: _____	

Rocket Specifications

Total Mass: _____g	Number of Fins: _____
Total Length: _____cm	Length of Nose Cone: _____cm
Width (widest part): _____cm	Volume of Rocket Fuel (H ₂ O) to be used on
Circumference: _____cm	Launch Day: _____mL, _____L

Rocket Stability

Center of Mass (CM)	Center of Pressure (CP)
Distance from Nose: _____cm	Distance from Nose: _____cm
Distance from Tail: _____cm	Distance from Tail: _____cm
Distance of CM from CP: _____cm	
Did your rocket pass the swing test? _____	



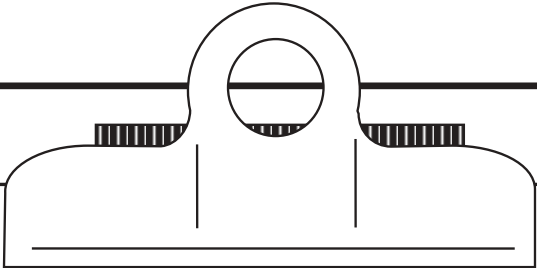

Flight Day Log

Date: _____

Time: _____

Project No.

Company Name: _____

Launch Director: _____

Weather Conditions: _____

Wind Speed: _____ Wind Direction: _____

Air Temperature: _____ °C

Launch Location: _____

Launch Angle (degrees): _____ Launch Direction: _____

Fuel (water) volume: _____ mL _____ L

Flight Altitude: _____ M

Evaluate your rocket's performance:

Recommendations for future flights:



Project X-35 Score Sheet

TOTAL SCORE:

Project No _____

Date _____

Company Name _____

Part I: Documentation - 50% of project grade

Neatness _____

Completeness _____

Accuracy _____

Order _____

On Time _____

SCORE:

Part II: Silhouette - 25% of project grade

Neatness _____

Completeness _____

Accuracy _____

Proper balance _____

Correct use of labels _____

SCORE:

Part III: Launch Results - 25% of project grade (teams complete this section)

a. Rocket Altitude _____ Rank _____

b. Expenditures and Penalty Fees _____
(Check total from Balance Sheet)

c. Final Balance _____
(New Balance on Balance Sheet)

d. Efficiency (Cost/Meter) _____
(Divide Investment (b) by Rocket Altitude (a))

e. Contract Award _____

f. Profit _____
(Contract Award (f) minus Expenditures (b))

SCORE:



Additional Extensions

- Construct models of historical rockets. Refer to the reference list for picture books on rockets to use as information on the appearance of various rockets. Use scrap materials for the models such as:

- Mailing tubes • Cardboard • Tubes from paper rolls • Spools
- Coffee creamer packages (that look like rocket engine nozzles)
- Egg-shaped hosiery packages (for nose cones) • Tape
- Styrofoam cones • Spheres • Cylinders • Glue

- Use rockets as a theme for artwork. Teach perspective and vanishing points by choosing unusual angles, such as a birds-eye view for picturing rocket launches.

- Research the reasons why so many different rockets have been used for space exploration.

- Design the next generation of spaceships.

- Compare rockets in science fiction with actual rockets.

- Follow up the rocket activities in this guide with construction and launch of commercial model rockets. Rocket kits and engines can be purchased from craft and hobby stores and directly from the manufacturer. Obtain additional information about model rocketry by contacting the National Association of Rocketry, P.O. Box 177, Altoona, WI 54720.

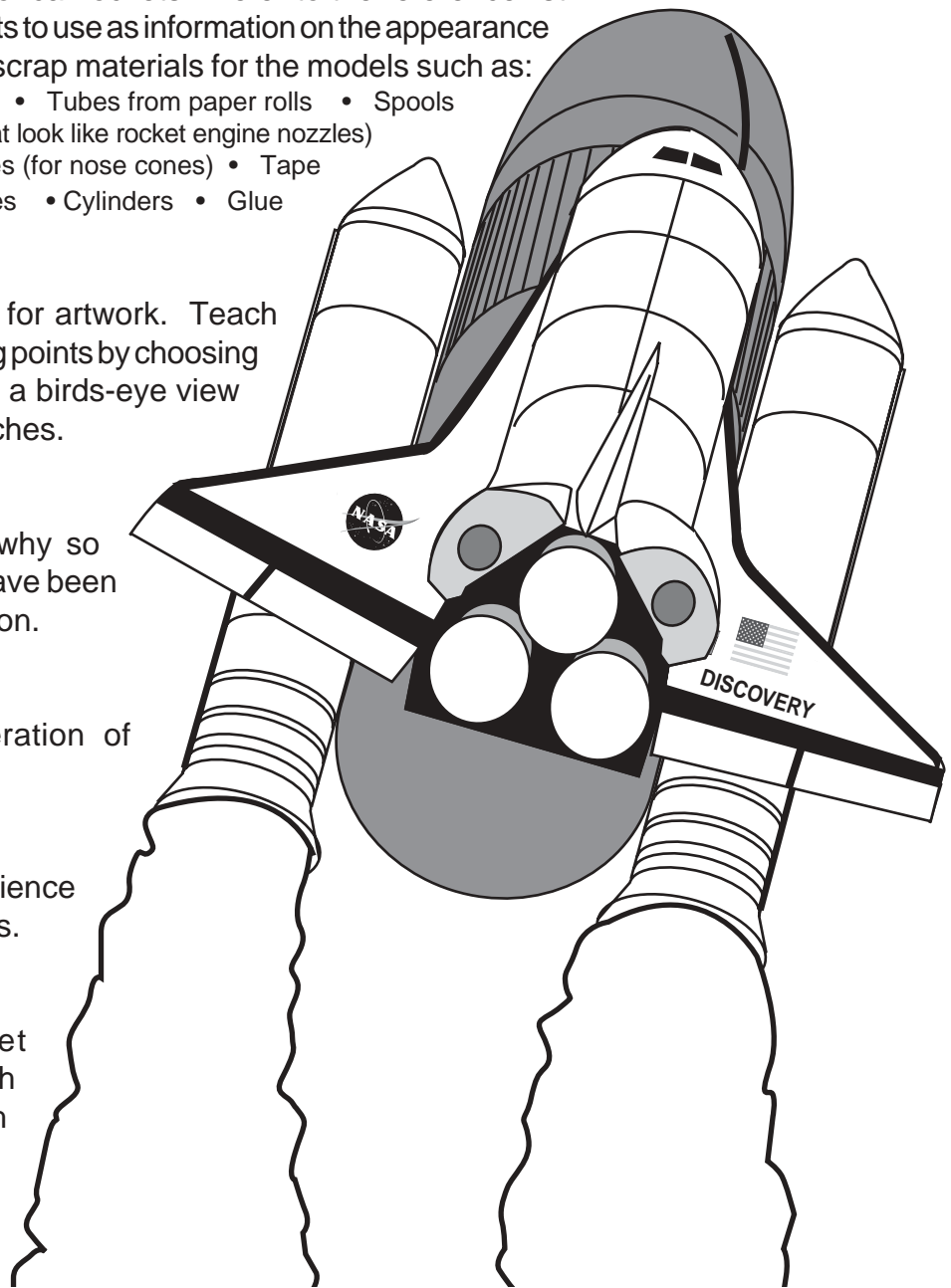

- Contact NASA Spacelink for information about the history of rockets and NASA's family of rockets under the heading, "Space Exploration Before the Space Shuttle." See the resource section at the end of this guide for details.



Glossary

Action - A force (push or pull) acting on an object. See Reaction.

Active Controls - Devices on a rocket that move to control the rocket's direction in flight.

Attitude Control Rockets - Small rockets that are used as active controls to change the attitude (direction) a rocket or spacecraft is facing in outer space.

Canards - Small movable fins located towards the nose cone of a rocket.

Case - The body of a solid propellant rocket that holds the propellant.

Center of Mass (CM) - The point in an object about which the object's mass is centered.

Center of Pressure (CP) - The point in an object about which the object's surface area is centered.

Chamber - A cavity inside a rocket where propellants burn.

Combustion Chamber - See Chamber.

Drag - Friction forces in the atmosphere that "drag" on a rocket to slow its flight.

Escape Velocity - The velocity an object must reach to escape the pull of Earth's gravity.

Extravehicular Activity (EVA) - Spacewalking.

Fins - Arrow-like wings at the lower end of a rocket that stabilize the rocket in flight.

Fuel - The chemical that combines with an oxidizer to burn and produce thrust.

Gimbaled Nozzles - Tiltable rocket nozzles used for active controls.

Igniter - A device that ignites a rocket's engine(s).

Injectors - Showerhead-like devices that spray fuel and oxidizer into the combustion chamber of a liquid propellant rocket.

Insulation - A coating that protects the case and nozzle of a rocket from intense heat.

Liquid Propellant - Rocket propellants in liquid form.

Mass - The amount of matter contained within an object.

Mass Fraction (MF) - The mass of propellants in a rocket divided by the rocket's total mass.

Microgravity - An environment that imparts to an object a net acceleration that is small compared with that produced by Earth at its surface.

Motion - Movement of an object in relation to its surroundings.

Movable Fins - Rocket fins that can move to stabilize a rocket's flight.

Nose Cone - The cone-shaped front end of a rocket.

Nozzle - A bell-shaped opening at the lower end of a rocket through which a stream of hot gases is directed.

Oxidizer - A chemical containing oxygen compounds that permits rocket fuel to burn both in the atmosphere and in the vacuum of space.

Passive Controls - Stationary devices, such as fixed rocket fins, that stabilize a rocket in flight.

Payload - The cargo (scientific instruments, satellites, spacecraft, etc.) carried by a rocket.

Propellant - A mixture of fuel and oxidizer that burns to produce rocket thrust.

Pumps - Machinery that moves liquid fuel and oxidizer to the combustion chamber of a rocket.

Reaction - A movement in the opposite direction from the imposition of an action. See Action.

Rest - The absence of movement of an object in relation to its surroundings.

Regenerative Cooling - Using the low temperature of a liquid fuel to cool a rocket nozzle.

Solid Propellant - Rocket fuel and oxidizer in solid form.

Stages - Two or more rockets stacked on top of each other in order to reach higher altitudes or have a greater payload capacity.

Throat - The narrow opening of a rocket nozzle.

Unbalanced Force - A force that is not countered by another force in the opposite direction.

Vernier Rockets - Small rockets that use their thrust to help direct a larger rocket in flight.



NASA Educational Materials

NASA publishes a variety of educational resources suitable for classroom use. The following resources, specifically relating to the topic of rocketry, are available from the NASA Teacher Resource Center Network. Refer to the next pages for details on how to obtain these materials.

Liftoff to Learning Educational Video Series That Relate to Rockets

Space Basics

Length: 20:55

Recommended Level: Middle School

Application: History, Physical Science

Space Basics explains space flight concepts such as how we get into orbit and why we float when orbiting Earth. Includes a video resource guide.

Newton in Space

Length: 12:37

Recommended Level: Middle School

Application: Physical Science

Newton in Space demonstrates the difference between weight and mass and illustrates Isaac Newton's three laws of motion in the microgravity environment of Earth Orbit. Includes a video resource guide.

Other Videos

Videotapes are available about Mercury, Gemini, Apollo, and Space Shuttle projects and missions. Contact the Teacher Resource Center that serves your region for a list of available titles, or contact CORE (See page 109.).

Publications

- McAleer, N. (1988), *Space Shuttle - The Renewed Promise*, National Aeronautics and Space Administration, PAM-521, Washington, DC.
- NASA (1991), *Countdown! NASA Launch Vehicles and Facilities*, Information Summaries, National Aeronautics and Space Administration, PMS-018-B, Kennedy Space Center, FL.
- NASA (1991), *A Decade On Board America's Space Shuttle*, National Aeronautics and Space Administration, NP-150, Washington, DC.
- NASA (1987), *The Early Years: Mercury to Apollo-Soyuz*, Information Summaries, National Aeronautics and Space Administration, PMS-001-A, Kennedy Space Center, FL.
- NASA (1991), *Space Flight, The First 30 Years*, National Aeronautics and Space Administration, NP-142, Washington, DC.
- NASA (1992), *Space Shuttle Mission Summary, The First Decade: 1981-1990*,

Information Summaries, National Aeronautics and Space Administration, PMS-038, Kennedy Space Center, FL.

Roland, A. (1985), *A Spacefaring People: Perspectives on Early Spaceflight*, NASA Scientific and Technical Information Branch, NASA SP-4405, Washington, DC.

Lithographs

HqL-367 Space Shuttle *Columbia* Returns from Space.

HqL-368 Space Shuttle *Columbia* Lifts Off Into Space.

Suggested Reading

These books can be used by children and adults to learn more about rockets. Older books on the list provide valuable historical information rockets and information about rockets in science fiction. Newer books provide up-to-date information about rockets currently in use or being planned.

- Asimov, I. (1988), *Rockets, Probes, and Satellites*, Gareth Stevens, Milwaukee.
- Barrett, N. (1990), *The Picture World of Rockets and Satellites*, Franklin Watts Inc., New York.
- Bolognese, D. (1982), *Drawing Spaceships and Other Spacecraft*, Franklin Watts, Inc., New York.
- Branley, F. (1987), *Rockets and Satellites*, Thomas Y. Crowell, New York.
- Butterfield, M. (1994), *Look Inside Cross-Sections Space*, Dorling Kindersley, London.
- Donnelly, J. (1989), *Moonwalk, The First Trip to the Moon*, Random House, New York.
- English, J. (1995), *Transportation, Automobiles to Zeppelins*, A Scholastic Kid's Encyclopedia, Scholastic Inc., New York.
- Fischel, E. & Ganeri, A. (1988), *How To Draw Spacecraft*, EDC Publishing, Tulsa, Oklahoma.
- Furniss, T. (1988), *Space Rocket*, Gloucester, New York.
- Gatland, K. (1976), *Rockets and Space Travel*, Silver Burdett, Morristown, New Jersey.
- Gatland, K. & Jeffris, D. (1977), *Star Travel: Transport and Technology Into The 21st Century*, Usborn Publishers, London.
- Gurney, G. & Gurney, C. (1975), *The Launch of Sputnik, October 4, 1957: The Space Age Begins*, Franklin Watts, Inc., New York.
- Malone, R. (1977), *Rocketship: An Incredible Voyage Through Science Fiction and Science Fact*, Harper & Row, New York.
- Maurer, R. (1995), *Rocket! How a Toy Launched the Space Age*, Crown Publishers, Inc., New York.
- Mullane, R. M. (1995), *Liftoff, An Astronaut's Dream*,



Silver Burdett Press, Parsippany, NJ.

Neal, V., Lewis, C., & Winter, F. (1995), Smithsonian Guides, Spaceflight, Macmillan, New York. (Adult level reference)

Parsons, A. (1992), What's Inside? Spacecraft, Dorling Kindersley, Inc., New York.

Ordway, F. & Leibermann, R. (1992), Blueprint For Space, Science Fiction To Science Fact, Smithsonian Institution Press, Washington DC.

Quackenbush, R. (1978), The Boy Who Dreamed of Rockets: How Robert Goddard Became The Father of the Space Age, Parents Magazine Press, New York.

Ride, S. & Okie, S. (1986), To Space & Back, Lee & Shepard Books, New York.

Shayler, D. (1994), Inside/Outside Space, Random House, New York.

Shorto, R. (1992), How To Fly The Space Shuttle, John Muir Publications, Santa Fe, NM.

Vogt, G. (1987), An Album of Modern Spaceships, Franklin Watts, Inc., New York.

Vogt, G. (1989), Space Ships, Franklin Watts, Inc., New York.

Winter, F. (1990), Rockets into Space, Harvard University Press, Cambridge, Massachusetts. (Adult level reference)

Commercial Software

Physics of Model Rocketry
Flight: Aerodynamics of Model Rockets
In Search of Space - Introduction to Model Rocketry
 The above programs are available for Apple II, Mac, and IBM from Estes Industries, 1295 H. Street, Penrose, Colorado 81240

Electronic Resources

The following listing of Internet addresses will provide users with links to educational materials throughout the World Wide Web (WWW) related to rocketry.

NASA Resources

NASA SpaceLink
<http://spacelink.nasa.gov>

NASA Home Page
<http://www.nasa.gov/>

Space Shuttle Information
<http://spaceflight.nasa.gov>



NASA RESOURCES FOR EDUCATORS

The Central Operation of Resources for Educators (CORE) was established for the national and international distribution of NASA-produced educational materials in multimedia format. Educators can obtain a catalog and an order form by one of the following methods:

Mail:
CORE
Lorain County Joint Vocational School
15181 Route 58 South
Oberlin, OH 44074-9799
Phone: 440-775-1400
Fax: 440-775-1460
E-mail: nasaco@leeca.org
<http://core.nasa.gov>

Educator Resource Center Network (ERCN)

To make additional information available to the education community, NASA has created the NASA Educator Resource Center (ERC) network. Educators may preview, copy, or receive NASA materials at these sites.

Phone calls are welcome if you are unable to visit the ERC that serves your geographic area. A list of the centers and the regions they serve includes the following:

AK, Northern CA, HI, ID, MT, NV, OR, UT, WA, WY

NASA Educator Resource Center

NASA Ames Research Center

Mail Stop 253-2

Moffett Field, CA 94035-1000

Phone: 650-604-3574

<http://amesnews.arc.nasa.gov/erc/erchome.html>

IL, IN, MI, MN, OH, WI

NASA Educator Resource Center

NASA Glenn Research Center

Mail Stop 8-1

21000 Brookpark Road

Cleveland, OH 44135

Phone: 216-433-2017

<http://www.grc.nasa.gov/WWW/PAO/html/edteachr.htm>

CT, DE, DC, ME, MD, MA, NH, NJ, NY, PA, RI, VT

NASA Educator Resource Laboratory
NASA Goddard Space Flight Center

Mail Code 130.3

Greenbelt, MD 20771-0001

Phone: 301-286-8570

<http://www.gsfc.nasa.gov/vc/erc.htm>

CO, KS, NE, NM, ND, OK, SD, TX

Space Center Houston

NASA Educator Resource Center for

NASA Johnson Space Center

1601 NASA Road One

Houston, TX 77058

Phone: 281-244-2129

http://www.spacecenter.org/educator_resource.html

FL, GA, PR, VI

NASA Educator Resource Center

NASA Kennedy Space Center

Mail Code ERC

Kennedy Space Center, FL 32899

Phone: 321-867-4090

<http://www-pao.ksc.nasa.gov/kscpao/educate/edu.htm>

KY, NC, SC, VA, WV

Virginia Air & Space Center

NASA Educator Resource Center for

NASA Langley Research Center

600 Settlers Landing Road

Hampton, VA 23669-4033

Phone: 757-727-0900 x757

<http://www.vasc.org/erc/>



AL, AR, IA, LA, MO, TN
U.S. Space and Rocket Center
NASA Educator Resource Center for
NASA Marshall Space Flight Center
One Tranquility Base
Huntsville, AL 35807
Phone: 256-544-5812
<http://erc.msfc.nasa.gov>

MS
NASA Educator Resource Center
NASA Stennis Space Center
Mail Stop 1200
Stennis Space Center, MS 39529-6000
Phone: 228-688-3338
<http://education.ssc.nasa.gov/erc/erc.htm>

CA
NASA Educator Resource Center for
NASA Jet Propulsion Laboratory
Village at Indian Hill
1460 East Holt Avenue, Suite 20
Pomona, CA 91767
Phone: 909-397-4420
http://learn.jpl.nasa.gov/resources/resources_index.html

AZ and Southern CA
NASA Educator Resource Center
NASA Dryden Flight Research Center
P.O. Box 273 M/S 4839
Edwards, CA 93523-0273
Phone: 661-276-5009
<http://www.dfrc.nasa.gov/trc/ERC/>

Eastern Shores of VA and MD
NASA Educator Resource Center for
GSFC/Wallops Flight Facility
Visitor Center Building J-17
Wallops Island, VA 23337
Phone: 757-824-2298
<http://www.wff.nasa.gov/~WVC/ERC.htm>

Regional Educator Resource Centers offer more educators access to NASA educational materials. NASA has formed partnerships with universities, museums, and other education institutions to serve as regional ERCs in many states. A complete list of regional ERCs is available through CORE, or electronically via NASA Spacelink at <http://spacelink.nasa.gov/ercn>

NASA's Education Home Page serves as the education portal for information regarding educational programs and services offered by NASA for the American education community. This high-level directory of information provides specific details and points of contact for all of NASA's educational efforts, Field Center offices, and points of presence within each state. Visit this resource at <http://education.nasa.gov>

NASA Spacelink is one of NASA's electronic resources specifically developed for the education community. Spacelink serves as an electronic library for NASA's educational and scientific resources, with hundreds of subject areas arranged in a manner familiar to educators. Using Spacelink Search, educators and students can easily find information among NASA's thousands of Internet resources. Special events, missions, and intriguing NASA Web sites are featured in Spacelink's "Hot Topics" and "Cool Picks" areas. Spacelink may be accessed at <http://spacelink.nasa.gov>

NASA Spacelink is the official home of electronic versions of NASA's educational products. A complete listing of NASA educational products can be found at <http://spacelink.nasa.gov/products>

NASA Television (NTV) features Space Station and Shuttle mission coverage, live



special events, interactive educational live shows, electronic field trips, aviation and space news, and historical NASA footage. Programming has a 3-hour block—*Video (News) File*, *NASA Gallery*, and *Education File*—beginning at noon Eastern and repeated four more times throughout the day. Live feeds preempt regularly scheduled programming.

Check the Internet for programs listings at <http://www.nasa.gov/ntv>

For more information on NTV, contact
NASA TV
Code P-2
NASA Headquarters
Washington, DC 20546-0001
Phone: 202-358-3572

NTV Weekday Programming Schedules (Eastern Times)

<i>Video File</i>	<i>NASA Gallery</i>	<i>Education File</i>
12–1 p.m.	1–2 p.m.	2–3 p.m.
3–4 p.m.	4–5 p.m.	5–6 p.m.
6–7 p.m.	7–8 p.m.	8–9 p.m.
9–10 p.m.	10–11 p.m.	11–12 p.m.
12–1 a.m.	1–2 a.m.	2–3 a.m.

How to Access Information on NASA’s Education Program, Materials, and Services (EP-2002-07-345-HQ) This brochure serves as a guide to accessing a variety of NASA materials and services for educators. Copies are available through the ERC network or electronically via NASA Spacelink.



NOTES



NOTES



ROCKETS

An Educator's Guide with Activities in Science, Mathematics, and Technology

EDUCATOR REPLY CARD

To achieve America's goals in Educational Excellence, it is NASA's mission to develop supplementary instructional materials and curricula in science, mathematics, geography, and technology. NASA seeks to involve the educational community in the development and improvement of these materials. Your evaluation and suggestions are vital to continually improving NASA educational materials.

Please take a moment to respond to the statements and questions below. You can submit your response through the Internet or by mail. Send your reply to the following Internet address:

http://ehb2.gsfc.nasa.gov/educats/educator_guide

You will then be asked to enter your data at the appropriate prompt.

Otherwise, please return the reply card by mail. Thank you.

1. With what grades did you use the guide?

Number of teachers/faculty:

_____ K-4 _____ 5-8 _____ 9-12 _____ Community College

_____ College/University _____ Undergraduate _____ Graduate

Number of students:

_____ K-4 _____ 5-8 _____ 9-12 _____ Community College

_____ College/University _____ Undergraduate _____ Graduate

Number of others:

_____ Administrators/Staff _____ Parents _____ Professional Groups

_____ General Public _____ Civic Groups _____ Other

2. a. What is your home 5- or 9-digit ZIP code? _____

b. What is your school's 5- or 9-digit ZIP code? _____

3. This is a valuable educator's guide.

Strongly Agree Agree Neutral Disagree Strongly Disagree

4. I expect to apply what I learned from this educator's guide.

Strongly Agree Agree Neutral Disagree Strongly Disagree

Fold along line and tape closed.

5. What kind of recommendation would you make to someone who asks about this educator's guide?

Excellent Good Average Poor Very Poor

6. How did you use this educator's guide?

Background Information Critical Thinking Tasks
 Demonstrate NASA Materials Demonstration
 Group Discussions Hands-On Activities
 Integration Into Existing Curricula Interdisciplinary Activity
 Lecture Science and Mathematics
 Team Activities Standards Integration

Other: Please specify: _____

7. Where did you learn about this educator's guide?

NASA Educator Resource Center
 Central Operation of Resources for Educators (CORE)
 Institution/School System
 Fellow Educator
 Workshop/Conference
 Other: Please specify: _____

8. What features of this educator's guide did you find particularly helpful?

9. How can we make this educator's guide more effective for you?

10. Additional comments:

Today's Date: _____

EG-2003-01-108-HQ



Please Place
Stamp Here
Post Office
Will Not Deliver
Without Proper
Postage

**NATIONAL AERONAUTICS AND SPACE ADMINISTRATION
EDUCATION DIVISION
MAIL CODE FE
WASHINGTON DC 20546-0001**



Fold along line and tape closed.