

RC Model Jet Engines

evoJet - B90 - B130vx - B160vx

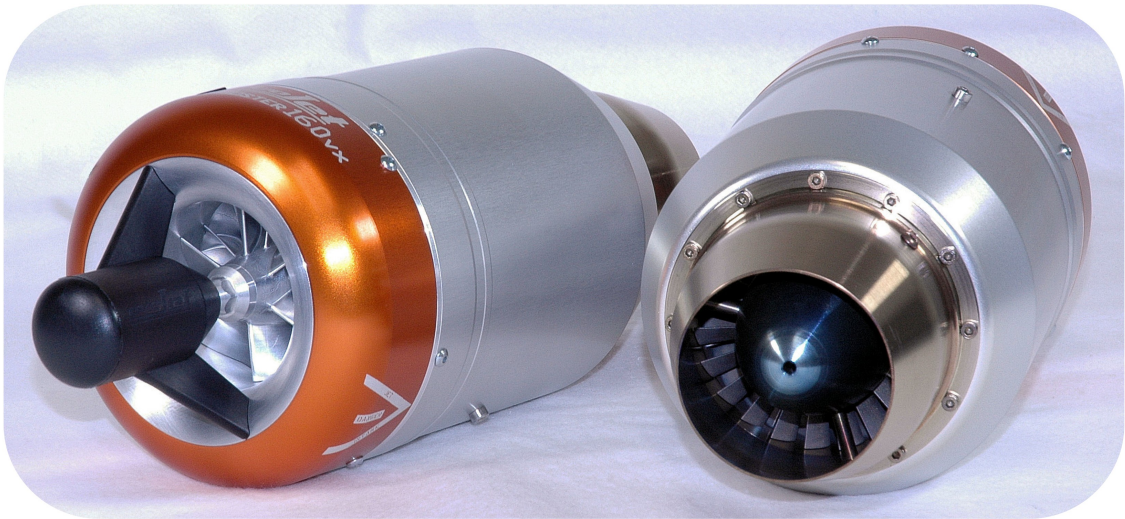

© 2005-2011 evoJet GmbH

Am Parir 4A

52379 Langerwehe – Germany

Tel.: +49 2423 / 401163 - Fax: 401217

support@evojet.de

<http://www.evojet.de/>

Contents

Introduction	3
Warnings and Safety Notes	4
Warranty Conditions.....	7
Technical Specifications.....	8
Installation Plan.....	9
Checklist for the First Operation.....	10
Checklist for Turning the Engine Off.....	10
EDT Status Display (Engine Data Terminal).....	11
JETRONIC-Vx – Firmware Setup.....	13
1:INFO Menu	14
2:STATISTICS Menu	18
3:LIMITS Menu	20
4:AUTOSTART Menu	22
5:R/C-SETTINGS Menu	24
6:TEST-DEVICES Menu	28
Airspeed Sensor [8135].....	31
Notes.....	33

Introduction

The model jet engines of the **evoJet-VX** series uses the same functional principle as a "big" jet engine. A high performance compressor compresses ingested air, which is then heated by a fuel flame in the combustion chamber. The heat causes the air to expand rapidly, enabling it to drive an axial turbine rotor, which in turn drives the aforementioned compressor via a shaft (open-circuit gas turbine).

At the exhaust cone, the hot air leaves the engine at a speed of more than 1000 km/h (620 mph), generating the required thrust for the jet aircraft model. An electric starter motor and a new electric kerosene ignition system allow fully automated engine control from the R/C transmitter, controlled and monitored by the JETRONIC control unit, which regulates all operating parameters to their optimal values. This new generation of model jet engines does not require dangerous auxiliary gases like propane or butane any more. Power is supplied to the engine by a separate rechargeable lithium-manganese battery, which is used to power all system components, such as fuel pump, kerosene ignition, valve etc.

State-of-the art precision CNC and laser cutting technology allow a previously impossible production accuracy, ensuring both high performance and durability. The included display and programming unit (EDT = Engine Data Terminal) is equipped with an illuminated LC-Display and can be connected to (and disconnected from) the running system at any time to check the current operating data or to change parameters. Besides the current operating parameters, such as exhaust gas temperature (EGT), turbine revolutions per minute (rpm) and thrust (throttle), additional information like total hours of operation, rpm and temperature statistics, number of engine starts, battery voltage etc. can be displayed as well.

All parameters and user entries are displayed in plain text in a menu-based interface. The turbine is started fully automatically via the throttle stick on the R/C transmitter. The pilot then adjusts the desired thrust by moving the stick proportionally. The JETRONIC control unit is connected to the R/C receiver via R/C-1. R/C-2 can be connected optionally for switching functions.

IMPORTANT NOTE:

Operating a jet aircraft model requires greatest care and special knowledge. When installing and operating your jet engine, always observe the safety rules in this manual !

Warnings and Safety Notes

Welcome to the era of model jet aircraft! Please never forget: Operating a jet engine like the **evoJet-VX** can be dangerous. An aircraft model equipped with the **evoJet-VX** can reach speeds of more than 400 km/h (250 mph) and temperatures up to 500 °C (930 °F) at the engine housing and up to 750 °C (1380 °F) at the exhaust jet. Since it is a genuine jet engine, it requires know-how, discipline and regular service and maintenance – for your own protection and that of other people. If you want to install and operate this jet engine in your model aircraft, you must be trained in its handling. The model with the jet engine should only be operated under supervision of an experienced person, who can support you in order to avoid mistakes. If there is a local R/C club in your area offering training and support, we recommend that you become a member. Mistakes made during the assembly or operation of a jet-powered model aircraft can lead to serious injuries or even death.

Always observe the law

Before operating a model aircraft with this jet engine, you should be informed about the legal regulations regarding such aircraft. From a legal point of view, a model aircraft is considered an aircraft like any other in most countries and is subject to the corresponding laws, which must be observed by all means. Please check the applicable air traffic laws of your country carefully before flying your model. Your local R/C club will likely be able to provide you with the required information and documents. In many countries, jet-powered model aircraft require a special licence and/or a special insurance. Furthermore, regulations regarding the protection against interference between R/C transmitters and radio networks must be observed. Please make sure to comply with all applicable laws and regulations in your country.

CAUTION – keep a safe distance!

It is your responsibility to protect others against injuries. The operating distance of your aircraft from residential areas must be at least 1.5 km (1 mile) in order to ensure the safety of people, animals and buildings. Keep a safe distance from power lines. Never fly your model in bad weather with low clouds or fog. Never fly directly against the sunlight – otherwise you might lose visual contact with your model. To avoid collisions with manned or unmanned aircraft, land your model immediately if an aircraft is approaching. Persons and animals must keep the following minimum distance to the jet engine (see also the figure on page 6):

In front of the engine: **1 m (3 ft)**

At the sides of the engine: **12 m (36 ft)**

Behind the engine: **10 m (30 ft)**

WARNING !

Operating the model and/or the jet engine under the influence of alcohol, drugs etc. is strictly forbidden. The jet engine may only be handled by persons with an excellent physical and mental condition and concentration. This applies to the operator as well as any assistants.

This jet engine was designed solely for use in model aircraft and is not suitable for any other purpose. Never use it for persons, objects or vehicles other than suitably constructed model aircraft, as any other use can lead to personal injury or death.

Any deviation from the specifications in this manual, the use of non-approved parts or materials or modifications to the system construction or setup can have a negative effect on the functionality and safety of the jet engine and must be avoided by all means.

WARNING !

The jet engine may only be operated in exact compliance with the instructions in this manual. Furthermore, the specifications of the aircraft model regarding the centre of gravity and rudder manipulations must be adhered to. The configuration recommended by the model manufacturer must be observed. Before taking off with a model equipped with this jet engine, all functions and all rudders as well as the range of the R/C transmitter must be tested with the transmitter turned on and the antenna retracted. This range test must be repeated with the jet engine running while another person is holding the model in place. Furthermore, the instructions by the R/C system manufacturer must be followed closely.

Disclaimer

evoJet cannot supervise the adherence to the assembly and operating instructions for the aircraft model and the jet engine, nor the installation, operation, use and maintenance of the model components. Therefore, **evoJet** does not assume any liability for losses, damage or costs caused by improper operation or improper behaviour or related in any other way to the aforementioned. Unless demanded by law, any liability of **evoJet** to pay compensation for damages for whatever reason (including personal injury, death, damage to buildings as well as loss of sales and profits, business interruption or other indirect or direct consequential loss caused by the operation of the model or the jet engine) is excluded. Under all circumstances and in any case, the joint liability is limited to the amount you actually paid for the model aircraft or jet engine.

The operation of the aircraft model and the jet engine takes place solely at the operator's own risk!

By operating the jet engine, you confirm to be aware of the fact that **evoJet** cannot supervise or control the compliance with the instructions in this manual regarding assembly, operation and use of the aircraft model, jet engine and remote control unit. From **evoJet's** side, no promises, contractual agreements, guarantees or other agreements with persons or companies regarding the functionality and operation of the model and the jet engine have been made. When buying this aircraft model or jet engine, you as the operator were relying on your own expertise and judgement.

Safety Notes

- ✓ Always have a fully functional CO₂ fire extinguisher with at least 2 kg (4.4 lb) of filling weight at hand.
- ✓ Only test the jet engine at suitable places outdoor and observe the applicable laws and regulations.
- ✓ Always keep the following safety distances from the running jet engine (1 m = 3 ft, 10 m = 30 ft, 12 m = 36 ft):

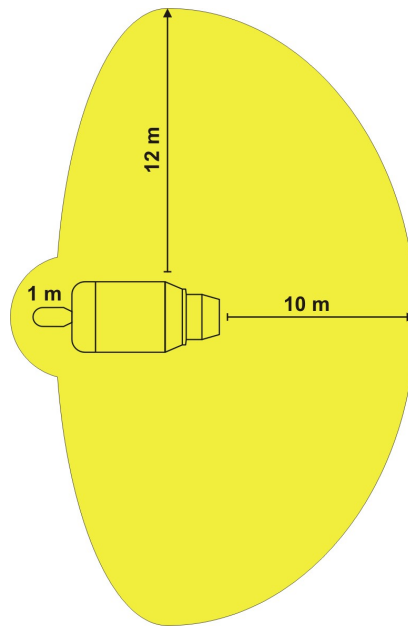

- ✓ Never look straight into the exhaust jet and never touch it with your hands.
- ✓ Whenever possible, wear hearing protection.
- ✓ Keep away from the engine intake (electric starter). The air stream has an enormous suction power, which can lead to severe injuries.
- ✓ After the first installation, and afterwards in regular intervals, test the transmission range of your R/C system with the jet engine running.
- ✓ Before operating the engine, remove all loose objects near the engine intake, such as cleaning cloths, screws, nuts, cables or other material. Before operating your model for the first time, make sure that there are no loose objects in the engine intake, such as clippings, screws or swarf from building the model. Such objects can damage the turbine. When installing the engine in your aircraft model, cover the engine intake and exhaust opening, for example with adhesive tape, to keep clippings/swarf and other objects from entering the engine.
- ✓ Make sure that about 5 % of turbine oil is added to the fuel. Use preferred special aircraft turbine oil like AEROSHELL 500/560.

Warning:

Compared to an ducted fan model aircraft, the model with a real jet engine reaches much higher airspeeds due to the considerably higher exhaust speed at the same static thrust. The achievable airspeeds of more than 300 km/h (190 mph) normally exceed the speed range an aircraft model is approved for (risk of rudder flutter, sudden nose dives and overload of the fuselage and the servos).

Therefore always take care of the following: After taking off and accelerating to normal airspeed, always pull the throttle back. For horizontal flight, 50 % of thrust is sufficient to achieve the same flight performance as with an ducted fan !

Only use the full thrust of the jet engine for takeoff and for vertical climbing in aerobatics!

For limiting the airspeed, we highly recommend using the optionally available Airspeed Sensor (part no. 8135) !

Warranty Conditions

The warranty covers the free repair or replacement of parts that exhibit proven defects of fabrication or material defects within the warranty period from the date of purchase. Any further claims are excluded. Costs for packaging and shipping are paid by the buyer. No liability is assumed for loss during transport. When sending the defective article to **evoJet** or to the service contractor in charge for the respective country, a detailed description of the fault and the invoice stating the date of purchase must be included. The warranty is void if the defect of the part or the model is caused by an accident, improper handling or improper use.

Technical Specifications

evoJet B90 – B130vx – B160vx	
Max. thrust:	B90: typ. 9 kg = 19 lb B130: typ. 14 kg = 31 lb B160: typ. 16 kg = 36 lb
Diameter:	B90: 91 mm = 3.6 inches B130/160: 112 mm = 4.4 inches
Length incl. starter:	B90: 230 mm = 9.06 inches B130/160: 288 mm = 11.3 inches
Weight:	B90: 950 g = 2.1 lb B130: 1595 g = 3.52 lb B160: 1620 g = 3.58 lb
Rotor speed:	B90: 45.000 – 165.000 rpm B130: 30.000 – 119.000 rpm B160: 30.000 – 123.000 rpm
Compressor:	Alloy 2618 compressor 12-blade
Turbine:	Axial-wheel Inconel
Fuel consumption:	B90: max. 285 g = 10.0 oz./min. B130: max. 420 g = 14.8 oz./min. B160: max. 520 g = 18.4 oz./min.
Fuel type:	Jet A1 / kerosene, approved fuel with 5 % oil
Maintenance interval:	B90: 300.000.000 B130/160: 200.000.000 corresponding 50 hours, see 24:JET-ENGINE (page 19)
Status:	October - 2010
(*) The engine thrust is electronically adjustable by setting the idle- and the full thrust revolution speed (page 21, 30:ENGINE-IDLE und 31:ENGINE-100%). All performance data are related to International Standard Atmosphere, ISA and optimal operating conditions which means, fuel, thrust tube and sufficient air supply.	

Checklist for the First Operation

- ✓ Install and connect the components according to the **installation plan** (see page 9). Pay special attention to the correct connection of the FUEL valve and to a proper laying of the tubes without kinking them. An arrow on the fuel pump and the valve indicates the flow direction to the engine.
- ✓ The QS quick connectors (blue) should snap in when you plug in the tube. The tube can only be released by pressing on the blue ring while pulling the tube out. Only use approved PUN tubes with a diameter of 3 mm (0.12") or 4 mm (0.16"), respectively.
- ✓ Check the temperature sensor to the environment temperature via the parameter AUTOSTART 47:EGT/AMBIENT (see page 23).
- ✓ Teach-in the remote control: OFF, IDLE, 100 %, via the R/C-SETTINGS parameters 51, 52, 53 (see page 25).
- ✓ Charge all batteries, paying special attention to the correct charging program for the lithium-manganese battery, i.e. a maximum charging voltage of 12.6 V. **Use the 3s LiPo charging mode with 1 – 2 Amps.**
- ✓ Open the fuel tank ventilation, then fill the fuel tank(s) with fuel containing approx. 5 % of oil, i.e. one can of turbine oil in 20 litres (5.3 US gallons) of kerosene.
- ✓ Have a CO₂ fire extinguisher at hand!
- ✓ Turn on the R/C transmitter, then turn on the receiver.
- ✓ Place your aircraft model with the nose against the wind.
- ✓ Start the jet engine (keep a safe distance, see page 6!):
 1. Throttle down + trim down => remove LOCK
 2. Trim up => RUN – cleared
 3. Throttle up and down again => AUTOSTART activated, see EDT display (page 11).

Checklist for Turning the Engine Off

- ✓ Place the aircraft model with the nose against the wind.
- ✓ Turn the jet engine off: Throttle down + trim down (below 25%) => -OFF
- ✓ Wait until the automatic cool-down procedure of the engine is finished.
- ✓ Check the INFO data about the operating states (see page 14 ff).
- ✓ After finishing the flight activities, remove all fuel from the tank(s) and close the fuel tank ventilation.

EDT Status Display (Engine Data Terminal)

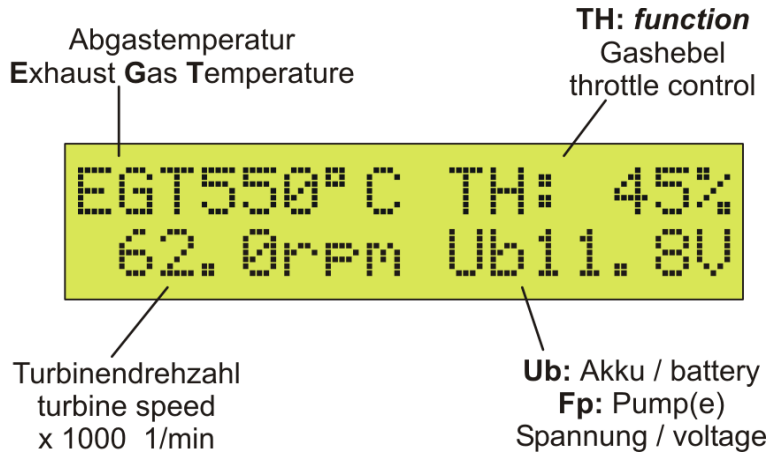

TH: = Throttle is a combined function display and error display for the engine operation.

Use the Up/Down keys to select different display values:

- Ub 11.8V** → current battery-Voltage.
- FP 2.1V** → current fuel-pump-Voltage.
- 0km/h** → current air-speed display in km/h (for telemetry).
- 0.00rPM** → current rotor-/propeller-speed (rpm).

Function display – example for a standard start-up procedure:

- TH: lock** → Remote control locked – to unlock it, pull the throttle and the trim all the way back. See also 51:RC1-TRIM.OFF (page 25).
 - TH: stop** → Remote control unlocked – engine off – to turn it on, push the trim up. See also 52:RC1-IDLE (page 25).
 - TH: run-** → Engine on – for a further check, push the throttle forward. See also 53:RC1-100% (page 25).
 - TH: rel-** → Check complete – to start the turbine, pull the throttle back to the IDLE position within 10 seconds.
- The fuelpump confirms the starting procedure with a short burst.**
- TH: fire** → Preheating of the kerosene igniter, this takes about 5 to 15 seconds.

- TH:spin** → Spin-up via the electric starter and fuel ignition.
See also 40:SPINUP/FIRE (page 23).
- TH:heat** → Heat-up phase of the kerosene igniter and the combustion chamber.
See also 44:HEAT-UP (page 23).
- TH:acce** → Acceleration of the turbine to normal operation.
See also 43:ACCE-RAMP (page 23).
- TH:cal.** → Calibration of the fuel pump and the fuel supply system.

TH:idle100% Thrust available to the pilot. **Ready for takeoff!**

TH:-off → To turn off the engine, pull the throttle **and** the trim all the way back.

TH:cool → The engine enters a controlled cool-down phase to ensure a long life of the high-performance bearings.

The error codes are explained under Firmware Setup 19:LAST-OFF on page 16/17.

Notice:

To learn-in a new fuel-system, let the jet engine run at least for 10 seconds at full speed (max-rpm).

Attention:

Dont do excessive full-throttle ground runs in the airplane without sufficient air supply !

JETRONIC-Vx – Firmware Setup

SETUP Menu

To enter the SETUP menu for configuring the firmware parameters, first press the SET key and then use the Up/Down keys to switch between the available parameter sections.

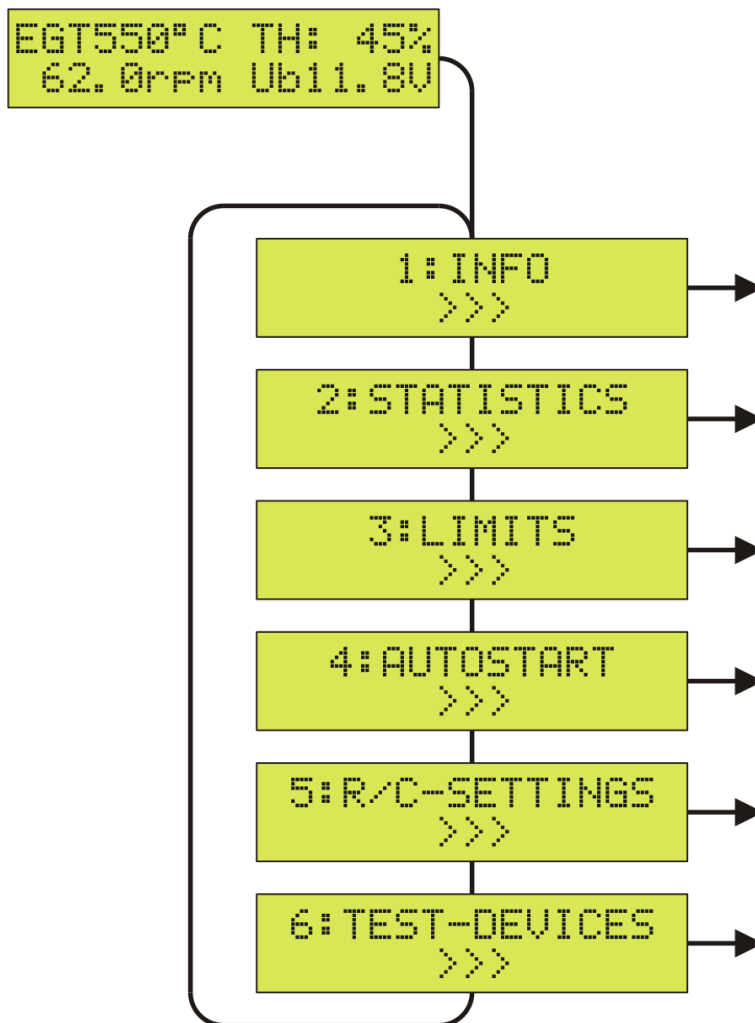

To quit the SETUP menu and to return to the operating status display, press the SET key for more than 2 seconds (ESC). In the following, the individual submenus of the SETUP menu are described.

1:INFO Menu

To enter the 1:INFO menu, first press the SET key and then use the Up/Down keys to switch between the available parameters.

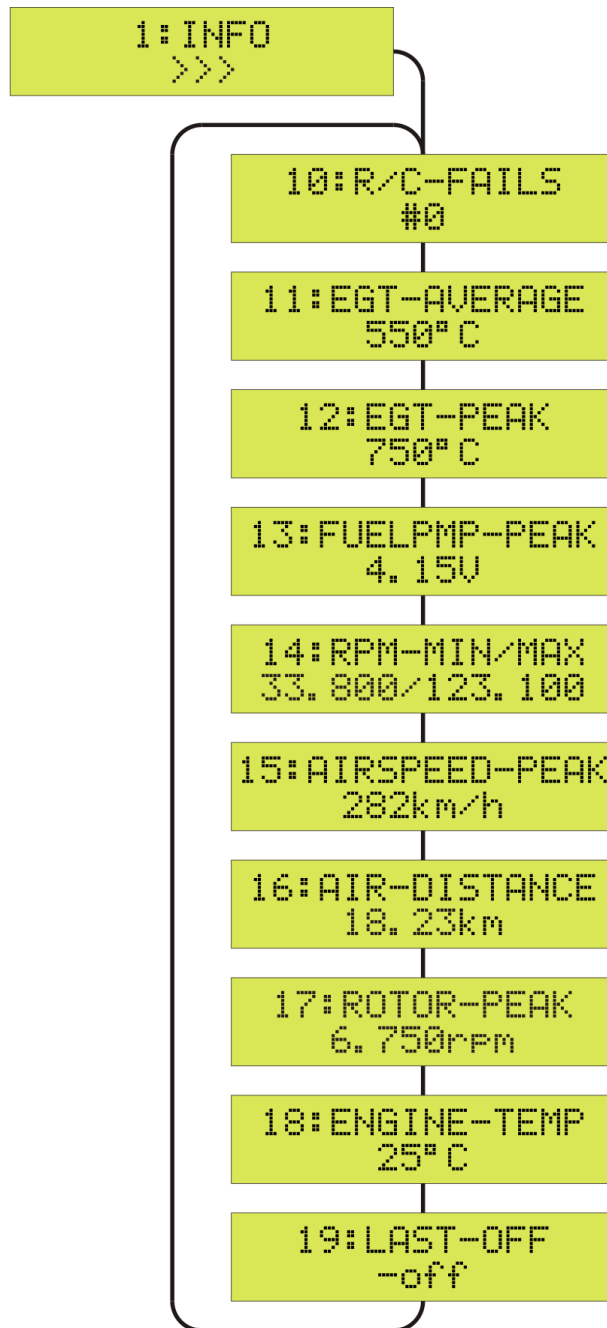

To quit the 1:INFO menu and to return to the SETUP menu, press the SET key for more than 2 seconds (ESC).

The operating status display appears automatically after 20 seconds, or press the SET key for more than 2 seconds (>>> changes to <<<, ESC).

1:INFO – Operating Status Information

10:R/C-FAILS

indicates the number of R/C failsafes (failures of the remote control connection) that lasted longer than one second during the last engine run. Normally this parameter should be #0, i.e. no failsafes. If the number is frequently greater than #0, you should check your remote control system. Do a Radio-Control range test !

11:EGT-AVERAGE

shows the average exhaust gas temperature during the last engine run. Typical values after a flight should be between 500 and 680 °C. Higher values might be caused by an unsuitable exhaust duct or insufficient ventilation to the turbine.

12:EGT-PEAK

shows the maximum exhaust gas temperature that occurred during the last engine run. This value is normally reached only briefly during the acceleration of the turbine until the higher revolution speed is reached. Typical values can be up to 850 °C.

13:FUELPMP-PEAK

shows the highest fuel pump voltage during the last engine run. A "!" after the "V" means that the maximum allowed pump voltage specified under LIMITS 33:FUELPMP-MAX has been reached. The maximum pump voltage is a good indicator for the quality (flow resistance) of the entire fuel supply system. An continuously increasing pump voltage after the flights may be caused by a plugged filter or fuel clunk.

14:RPM-MIN/MAX

shows the lowest and the highest revolution speed of the turbine during the last engine run. Normally, this value should match the rpm values specified under LIMITS 30:ENGINE-idle and LIMITS 31:ENGINE-100% in the variation of (± 300 rpm). If the 100 % thrust rpm value has not been reached, the reason might be a kinked fuel tube or a plugged filter or fuel clunk. It is also possible that the maximum fuel pump voltage specified under LIMITS 33:FUELPMP-MAX is set too low.

15:AIRSPEED-PEAK

shows the maximum airspeed during the last flight. This requires the Airspeed-Sensor [8135] to be installed and the parameter 59:AUX-MODE to be set to AIRSPEED.

16:AIR-DISTANCE

shows the distance covered during the last flight. This requires an airspeed sensor to be installed and the parameter 59:AUX-MODE to be set to AIRSPEED.

17:ROTOR-PEAK

shows the maximum revolution speed of the propeller/rotor during the last engine run. See also LIMITS 38:ROTOR-MAX.

18:ENGINE-TEMP

shows the current temperature under the turbine cover in °Celsius.

19:LAST-OFF - error codes,
shows the reason or error causing the engine shutdown:

-off Regular switchoff of the engine via the R/C transmitter or via the SET key in the case of a manual test run without remote control.

R/C! Same as **-off** regular switchoff, but with a hint as to counted radio failsafes.
See 10:R/C-FAILS, failures of the remote control connection.

Solution: Check the remote control system and do a transmission range test!

noID The engine is not detected or is not connected.

Solution: Turn the JETRONIC off and on again and/or check the cables and plugs.

badG The glow plug is defective or too cold. This error can also be caused by a weak or empty turbine battery.

Solution: Charge the turbine battery and/or check the cables and plugs.

main Internal hardware error, overheating or bad contacts

Solution: Let the JETRONIC unit cool down and/or check the cables and plugs.

strR The starter motor does not deliver sufficient power to continue the starting procedure.

Solution: Charge the turbine battery and/or check the cables and plugs.

It is also possible that the clutch rubber of the starter is oily or worn out. Carefully clean it with a cotton bud and glass cleaning agent.

minR The revolution speed falls below the required value during the startup procedure. This is usually caused by air bubbles in the fuel supply system leading to a flameout in the combustion chamber.

Solution: Make sure that the fuel supply is sufficient and uninterrupted.

minT The exhaust gas temperature falls below the value specified under LIMITS 34:EGT-MIN. This is usually caused by air bubbles in the fuel supply system leading to a flameout in the combustion chamber. Accompanied by considerable smoke emissions.

Solution: Use a better fuel tank system with a membrane fuel clunk or an AirTrap tank.

maxT The exhaust gas temperature exceeds the value specified under LIMITS 36:EGT-OFF.
Reasons may be:

- ➔ Large air bubbles in the fuel supply system
- ➔ A fuel puddle in the turbine

Solution: Hold a cloth against the engine intake and tilt the engine or the aircraft model upright with the intake facing down, so the fuel flows out of the engine into the cloth.
Caution: Take care not to pollute the starter motor and/or the clutch!

- ➔ The clutch rubber of the starter motor is oily or worn out.

Solution: Carefully clean it with a cotton bud and glass cleaning agent.

time The time limit for the startup procedure is exceeded.
Probably a fuel tube is kinked or plugged.

Solution: Check the laying of the fuel tubes and the fuel tank.

ovrR The revolution speed exceeds the value specified under LIMITS 31:ENGINE-100%. This is usually caused by air bubbles in the fuel supply system.

Solution: Use a better fuel tank system with a membrane fuel clunk or an AirTrap tank.

evoJet B90 – B130vx – B160vx – Instructions 4.0

runR The revolution speed falls below the value specified under LIMITS 33:ENGINE-MIN. This is usually caused by air bubbles in the fuel supply system leading to a flameout in the combustion chamber. Accompanied by considerable smoke emissions.

Solution: Use a better fuel tank system with a air-membrane fuel clunk or an AirTrap tank.

Solution: Increase the LIMITS: 33THROTTL-UP e.g. to 5 sec's !

lowB The minimum voltage of the turbine battery has been reached and the safety limitation has been activated (throttle can only up to 50 %, lowB). To receipt this, immediately throttle down to idle and land the airplane. If the minimum system voltage is reached, a safety shutoff takes place (lowB, lowB).

Solution: Charge the turbine battery and/or check the cables and plugs.

highB An overvoltage of the turbine battery has been detected.

Solution: Check the turbine battery, connect the right battery type and/or check the AUTOSTART 46:BATTERY battery type settings.

R/C? The RC1 remote control signal was not detected for a longer time than specified under R/C-SETTINGS 57:FAILS-TIME, or the RC2 remote control signal was not detected for more than one second.

Solution: Check the remote control system and do a transmission range test!

toIF The sensors of the engine deliver invalid measurement signals. This means that the engine can no longer be controlled and must be shut down (safety shutoff).

Solution: Charge the turbine battery and/or check the cables and plugs.

The trim down (below 50%=mid) removes the error codes and enables the jet engine again:

Restart the jet engine (keep a safe distance, see page 6!):

1. Throttle down + trim down (below 50%) => remove LOCK
2. Trim up => RUN – cleared
3. Throttle up and down again => AUTOSTART activated, see EDT display (page 11).

2:STATISTICS Menu

To enter the 2:STATISTICS menu, first press the SET key and then use the Up/Down keys to switch between the available parameters.

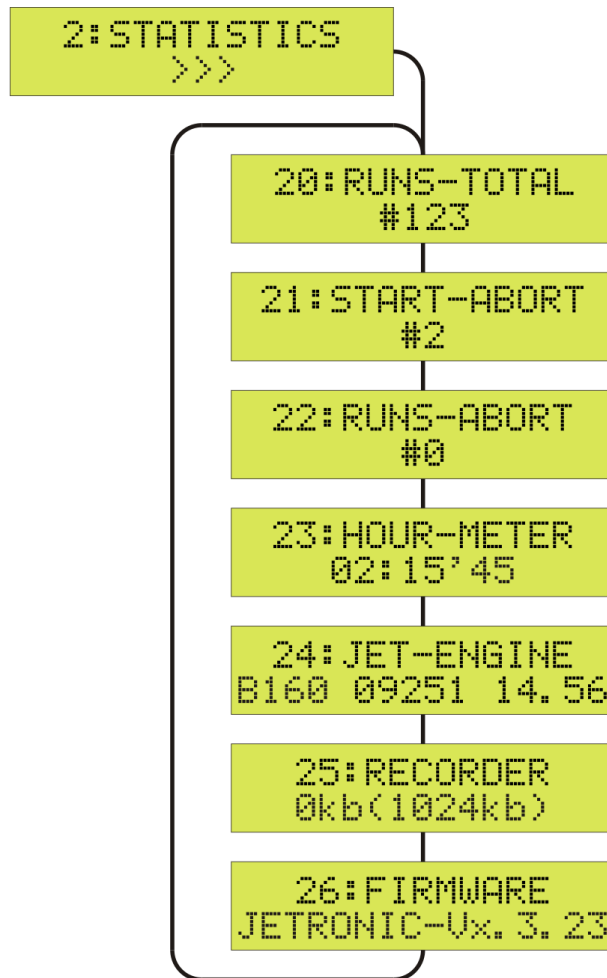

To quit the 2:STATISTICS menu and to return to the SETUP menu, press the SET key for more than 2 seconds (ESC).

The operating status display appears automatically after 20 seconds, or press the SET key for more than 2 seconds (>>> changes to <<<, ESC).

2:STATISTICS – Display of Operating Statistics

20:RUNS-TOTAL

shows the total number of engine runs or engine starts so far.

Unit: #

21:START-ABORT

shows the total number of aborted engine starts.

Unit: #

22:RUNS-ABORT

shows the total number of aborted engine runs where PWR shows the number of power-failures.

Unit: # PWR:#

23:HOURL-METER

shows the total operating time of the jet engine resp. the fuel pump.

Unit: HH:MM'SS

24:JET-ENGINE

shows the identification, serial number and lifetime of the connected jet engine.

Unit: ID SERIAL LIFE

B160#09123# 1.50

type year+serial lifetime

The lifetime value indicates the total number of turbine revolutions in millions.

A ! after the serial number means "stored value", for example with no engine connected.

25:RECORDER

shows the memory amount of the recorder unit.

Unit: record-kb (total-kb)

26:FIRMWARE

shows the info string of the current firmware with the version number.

3:LIMITS Menu

To enter the 3:LIMITS menu, first press the SET key and then use the Up/Down keys to switch between the available parameters.

To change a setting, first press the SET key and then use the Up/Down keys to switch between the available values. A ? indicates the value to be set. To finish the setting and store the new value, press the SET key again.

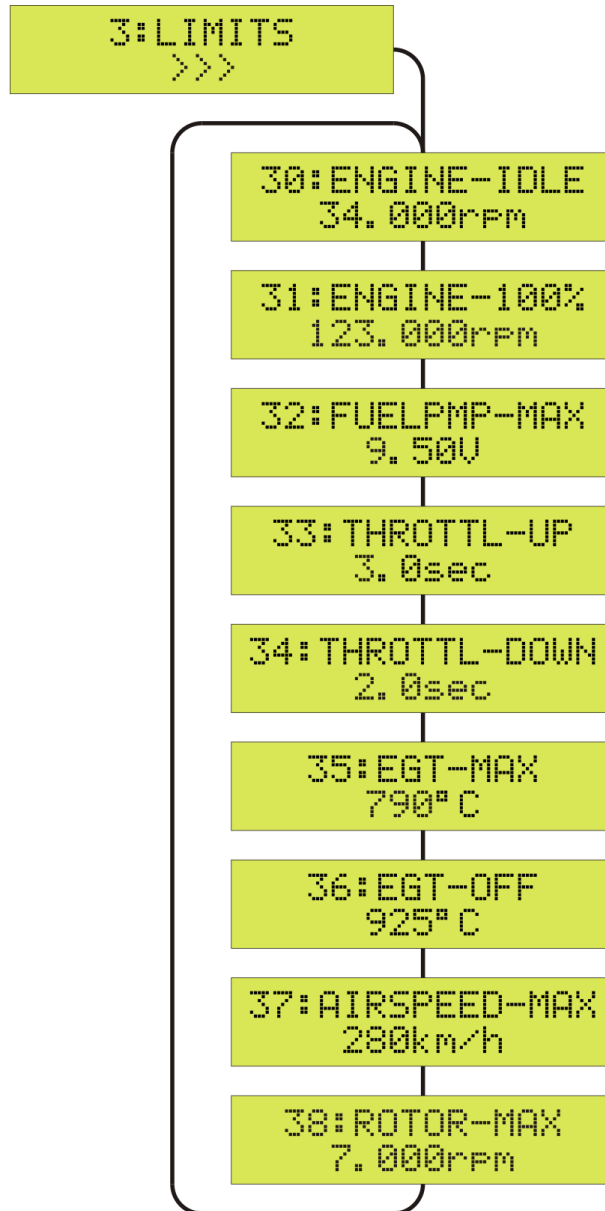

To quit the 3:LIMITS menu and to return to the SETUP menu, press the SET key for more than 2 seconds (ESC).

The operating status display appears automatically after 20 seconds, or press the SET key for more than 2 seconds (>>> changes to <<<, ESC).

3:LIMITS – Adjusting the evoJet Engine

CAUTION: Do not change any settings in the LIMITS menu unless you know exactly what effect the respective change will have! Wrong settings can lead to serious problems during the operation of your jet engine.

30:ENGINE-IDLE

This parameter specifies the idle revolution speed when the throttle is in the idle position.
Recommend values B90: 50.000 rpm B130/B160: 34.000 rpm

31:ENGINE-100%

This parameter specifies the full thrust revolution speed (100 %) when the throttle is in the full thrust position.
Standard values B90: 160.000 rpm B130: 117.000 rpm B160: 120.000 rpm
If this setting is changed, the INFO parameters 13:EGT-PEAK, 14:FUELPMP-PEAK and 15:RPM-PEAK are reset.

32:FUELPMP-MAX

This parameter specifies the maximum allowed voltage [V] for the fuel pump.
Standard values B90: 5.5 Volt B130: 8.5 Volt B160: 9.9 Volt
If this setting is changed, the INFO parameters 14:FUELPMP-PEAK and 15:RPM-PEAK are reset.

33:THROTTL-UP

This parameter specifies the acceleration/throttle-up time (more thrust) of the engine.
Recommend values B90: 4.0 sec B130/B160: 3.0 sec

34:THROTTL-DOWN

This parameter specifies the deceleration/throttle-down time (less thrust) of the engine.
Standard values B90: 3.4 sec B130/B160: 2.0 sec

35:EGT-MAX

This parameter specifies the maximum exhaust gas temperature for the engine control.
Standard value: 790 °C (1454 °F)

36:EGT-OFF

This parameter specifies the exhaust gas temperature for a safety break during the startup.
Standard value: 840 °C (1700 °F)

37:AIRSPEED-MAX

This parameter specifies the maximum allowed airspeed, above which the thrust of the engine is automatically reduced. To use this function, set 59:AUX-MODE to AIRSPEED (enables the AIRSPEED-SENSOR [8135]) and maybe set 54:RC2-MODE to AIRSPEED (RC2 switches the limiting OFF/ON from the Radio). If RC2-MODE = AIRSPEED is not used the limiter is default ON.
Standard value: 250 km/h (155 mph)
This function requires the Airspeed-Sensor (part no. 8135) to be installed. See page 31.

38:ROTOR-MAX

This parameter specifies the propeller/rotor revolution speed for turboprop and helicopter.

4:AUTOSTART Menu

To enter the 4:AUTOSTART menu, first press the SET key and then use the Up/Down keys to switch between the available parameters.

To change a setting, first press the SET key and then use the Up/Down keys to switch between the available values. A ? indicates the value to be set. To finish the setting and store the new value, press the SET key again.

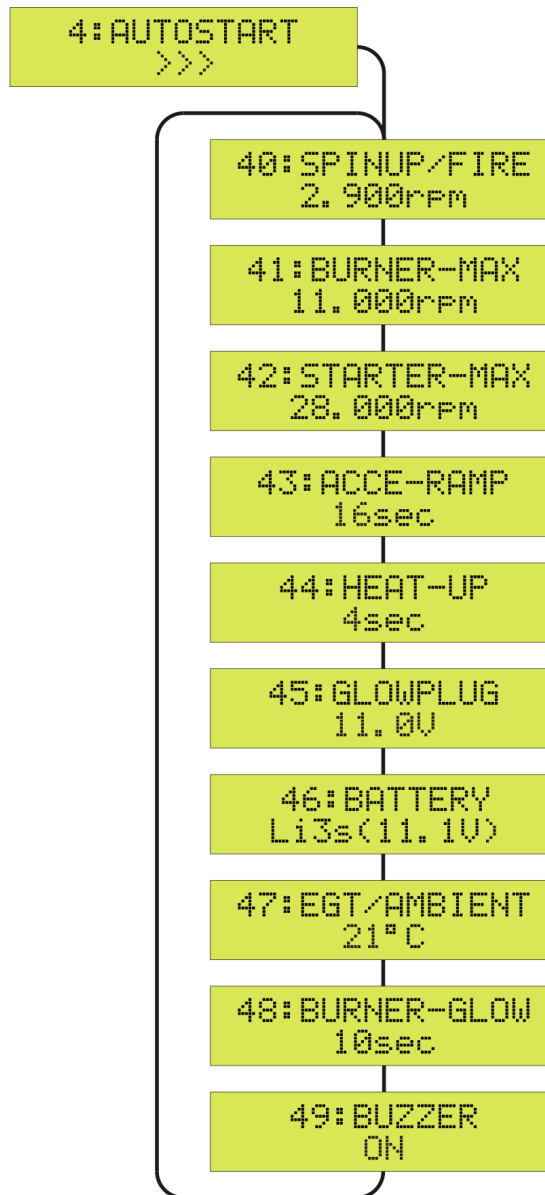

To quit the 4:AUTOSTART menu and to return to the SETUP menu, press the SET key for more than 2 seconds (ESC).

The operating status display appears automatically after 20 seconds, or press the SET key for more than 2 seconds (>>> changes to <<<, ESC).

4:AUTOSTART – General Startup Settings

CAUTION: Do not change any settings in the AUTOSTART menu unless you know exactly what effect the respective change will have! Wrong settings can lead to serious problems during the operation of your jet engine.

40:SPINUP/FIRE

This parameter specifies the revolution speed at which the ignition takes place during the spin-up of the turbine.

Standard value B90: 3.100 rpm B130/160: 2.900 rpm

41:BURNER-MAX

This parameter specifies the revolution speed at which the start burner is switched off.

Standard value B90: 9.000 rpm B130/B160: 8.000 rpm

42:STARTER-MAX

This parameter specifies the maximum revolution speed for the electric starter.

Standard value B90: 32.000 rpm B130/B160: 28.000 rpm

43:ACCE-RAMP

This parameter specifies the time for the acceleration ramp.

Standard value: 16 seconds

44:HEAT-UP

This parameter specifies the time for the combustion chamber heating phase.

Standard value: 3 seconds

45:GLOWPLUG

This parameter specifies the voltage [V] for the glow plug.

Standard value : 11.0 Volt

46:BATTERY

This parameter specifies the type of supply battery (battery low detection).

Standard value: Li3s (11.1 V)

Possible are:

Ni: 10-cells(12V) - NiCd/NiMh (min. SUB-C 2400/3000 size)

Li: 3s-cells(11.1V) - LithiumMangan/LiPo min. 20C

A123: 4s-cells(13.2V) - A132 Lithium-Eisen

Only use approved turbine batteries with sufficient capacity and high-current, such as the lithium-manganese batteries.

47:EGT/AMBIENT

Use this parameter to adapt the temperature sensor (EGT zero point) to the current ambient temperature e.g. 21 °C (@ 70 °F)

48:BURNER-GLOW

This parameter specifies the minimum preheattime for the electrical burner.

Standard value: 14 seconds

In the cold period where battery voltage and fuel temperature are low, an increase of the minimum burner preheattime to i.e. 22 seconds may improve the engine startup performance.

5:R/C-SETTINGS Menu

To enter the 5:R/C-SETTINGS menu, first press the SET key and then use the Up/Down keys to switch between the available parameters.

To change a setting, first press the SET key and then use the Up/Down keys to switch between the available values. A ? indicates the value to be set. To finish the setting and store the new value, press the SET key again.

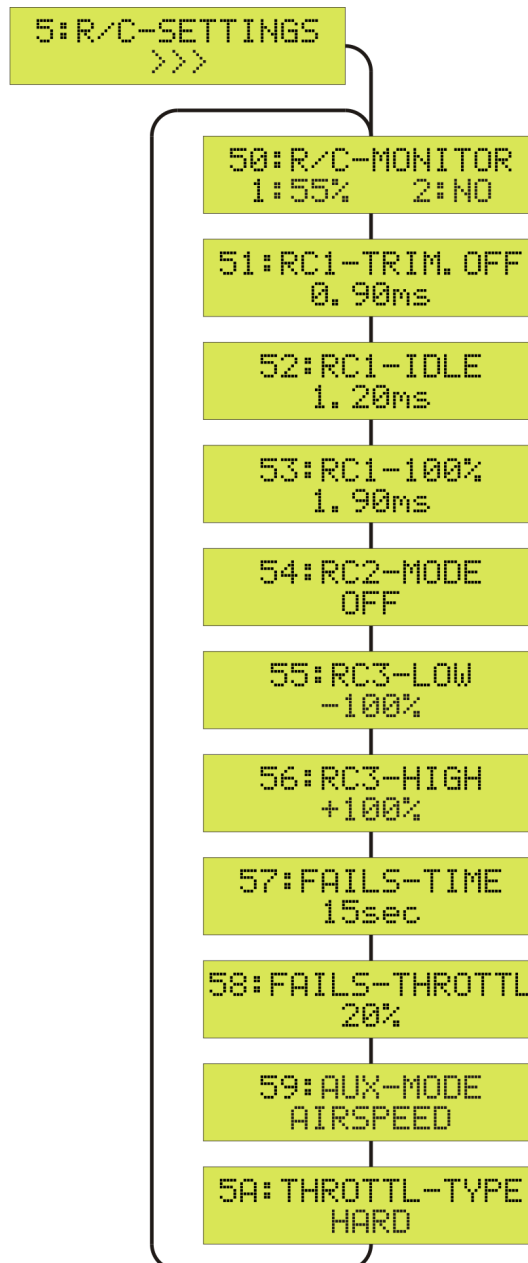

To quit the 5:R/C-SETTINGS menu and to return to the SETUP menu, press the SET key for more than 2 seconds (ESC).

The operating status display appears automatically after 20 seconds, or press the SET key for more than 2 seconds (>>> changes to <<<, ESC).

5:R/C-SETTINGS – Adapting the JETRONIC Unit to your R/C System

CAUTION: Do not change any settings in the R/C-SETTINGS menu unless you know exactly what effect the respective change will have! Wrong settings can lead to serious problems during the operation of your jet engine.

In the standard setup, RC1 is used for the throttle and the trim is used as an ON/OFF switching function. You can also use RC2 as an additional ON/OFF safety switch. The remote control signals RC1 and RC2 must have a **positive** servo travel way, i.e. short pulses (-100 %) for OFF or IDLE and long pulses (+100 %) for ON or 100 % / full thrust. This complies with the **JR/evoJet** standard setting. For Futaba or Multiplex transmitters, you may have to use the servo reverse switch.

The parameters printed in blue (51, 52, 53) are necessary settings to be made before the first operation of the jet engine!

50:R/C-MONITOR

shows the current signals at the RC1 and RC2 inputs. For RC1 (throttle), the current throttle/thrust setting is displayed:

NO = no signal
LOCK = throttle and trim OFF = 51:RC1-TRIM.OFF or FAILSAFE detected.
FAIL = throttle and trim are below the 51:RC1-TRIM.OFF or above the 53:RC1-100% settings. FAILsafe detection !
0-100% = throttle / thrust in % between 52:RC1-IDLE and 53:RC1-100%

In addition to the trim signal, the RC2 input can be used as a safety switch. To do so, set the parameter 54:RC2-MODE to SAFETY.

NO = no signal
OFF = OFF signal (-100 %)
ON = ON signal (+100 %) = unlocked

51:RC1-TRIM.OFF

Teach-in the RC1 signal for the position "engine = OFF" (shortest pulse). Activate the teach mode with the SET key. The new pulse length is shown on the display. Use the throttle stick to checkout the pulse length value. Move the throttle and the trim to the OFF position (throttle and trim all the way back). To finish the adjustment and store the new value, press the SET key again.

Standard value: 1.00 ms

52:RC1-IDLE

Teach-in the RC1 signal for the position "engine = IDLE" (trim forward, throttle all the way back). The new pulse length is shown on the display. To finish the adjustment and store the new value, press the SET key again.

Standard value: 1.25 ms

53:RC1-100%

Teach-in the RC1 signal for the position "engine = 100 % / full thrust" (longest pulse). Activate the teach mode with the SET key and move the throttle to the 100 % / full thrust position (trim and throttle all the way forward). The new pulse length is shown on the display. To finish the adjustment and store the new value, press the SET key again.

Standard value: 2.00 ms

54:RC2-MODE

Selecting the RC2 signal function

Standard value: OFF

OFF = control only via RC1 (throttle and trim).

SMOKE-VALVE

= switching function for a smoker valve 5V/100mA connected to the AUXiliary port
OFF = -100%, ON = +100%.

For this set 59:AUX-MODE to **SMOKER-VALVE**. The smoker function is enabled when the turbine is running or when using the testfunction 65:SMOKER-RC2.

AIRSPEED

= switching function for the airspeed limiter
OFF = -100%, ASL(AirSpeedLimiter) = +100%
see also 37:AIRSPEED-MAX and 59:AUX-MODE.

SMOKE-PUMP

= switching function for a smokepump connected to the RC3 terminal.

OFF = -100% =>**55:RC3-LOW** / ON = +100% =>**56:RC3-HIGH**

At 55: the OFF and at 56: the full power is adjustable.

The smoker function is enabled when the turbine is running or when using the testfunction 65:SMOKER-RC2.

55:RC3-LOW

Adjusting the LOW-signal for the RC3-output.
Standard value: -100%

56:RC3-HIGH

Adjusting the HIGH-signal for the RC3-output.
Standard value: +100%

57:FAILS-TIME

Adjusting the hold time for the RC1 signal in the case of a remote control failure (failsafe).
If the RC1 signal is out the range between the values defined at 51:RC1-TRIM.OFF and 53:RC1-100%, a remote control failure (failsafe) is detected. During the time specified here, the JETRONIC will automatically set the throttle to the value defined at 58:FAILS-THROTTL.
If the failsafe state persists after this time has elapsed, the jet engine is switched off automatically.
Standard value: 5 seconds

58:FAILS-THROTTL

Adjusting the thrust level in the case of an RC1 signal failure (failsafe)
Standard value: 20 %

59:AUX-MODE

Selecting the AUXiliary function / connection to the JETRONIC - AUX

OFF = no function

AIRSPEED = airspeed sensor connected, 37:AIRSPEED-MAX active!

WARN-LED = Low rpm / overheating indicator with external LED

SMOKER-VALVE
= A smoker valve 5V/100mA can be connected.

5A:THROTTL-TYPE

Selecting the throttle transferfunction for the engine speed (throttlecurve).

SOFT = The Throttle works rpm-linear, e.g. softer in the lower rpm range.
Better for smaller and lighter airplanes.

HARD = The Throttle works thrust-linear, e.g. quicker in the lower rpm range.
Better for bigger and heavy airplanes.

6:TEST-DEVICES Menu

To enter the 6:TEST-DEVICES menu, first press the SET key and then use the Up/Down keys to switch between the available test functions.

To activate a test function, first press the SET key and then use the Up/Down keys to test the individual system components (devices). A ? indicates the value to be set. To finish the test, press the SET key again.

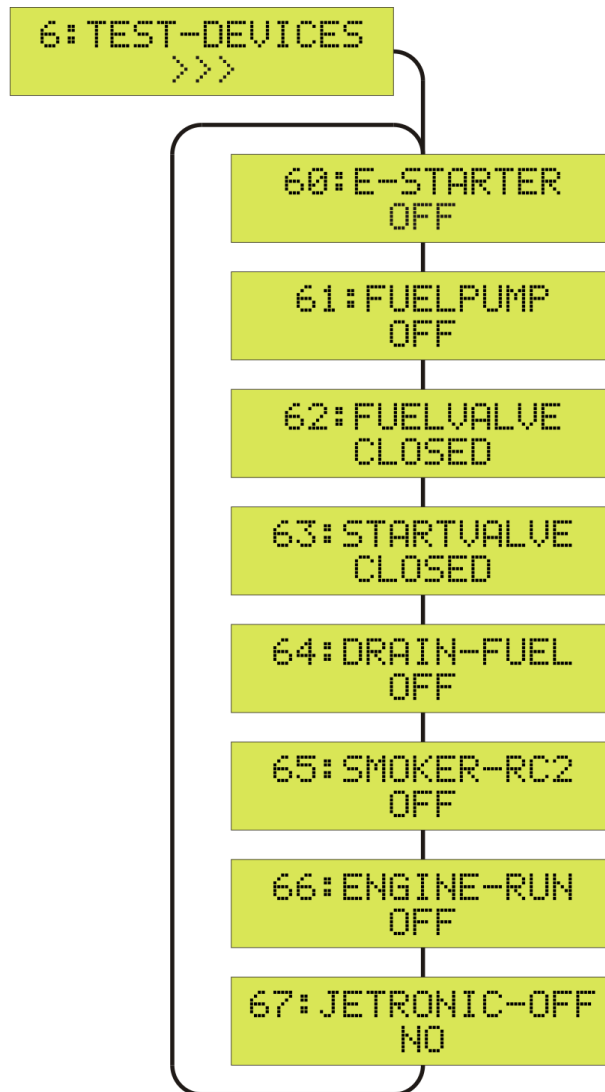

To quit the 6:TEST-DEVICES menu and to return to the SETUP menu, press the SET key for more than 2 seconds (ESC).

The operating status display appears automatically after 20 seconds, or press the SET key for more than 2 seconds (>>> changes to <<<, ESC).

6:TEST-DEVICES – Checkout system components

The parameters printed in blue are important tests that should be done before the first operation of the jet engine!

60:E-STARTER

Manual operation of the electric starter with the Up/Down keys

The starter motor should accelerate the turbine to 2000 rpm for at least 3 seconds.

Standard value: OFF

61:FUELPUMP

Manual operation of the fuel pump with the Up/Down keys

The FUELvalve can be opened too for priming the fuelline - just push both buttons simultaneous and take care not to flood the engine !

Standard value: OFF

62:FUELVALVE

Manual opening of the FUELvalve with the Up/Down keys

It must be connected to the left socket-pins at the JETRONIC (FUELvalve).

Standard value: CLOSED

63:STARTVALVE

Not necessary with evoJet-VX engines.

Standard value: CLOSED

64:DRAIN-FUEL

Use this function to pump the fuel back from the engine into the fuel cells. For this purpose, the fuel pump is running backwards and both fuel valves are activated. This function is useful if you want to store your model for a longer period or make modifications to it.

Standard value: OFF

65:SMOKER-RC2

Manually enabling the smokerfunction for a test with RC2. For this press the Up/Down key.

Standard value: OFF – OPEN

66:ENGINE-RUN

Starting and testing the jet engine without the remote control

Activate the test run with the Up key (ON) and press the SET key to switch to the operating status display:

The throttle/thrust display now shows **-rel** (release) and waits for your clearance with the Down key: The fully automatic starting procedure is activated.

Operation: You can stop the test run at any time with the SET key (like an emergency switch).
With the Up/Down keys, you can adjust the thrust between IDLE and 100 % (similar to the R/C throttle).

CAUTION: Please keep in mind that a stationary test run of the jet engine can lead to very high temperatures in the aircraft model (exhaust duct) due to the reduced airflow.

67:JETRONIC-OFF

Manual switching of the JETRONIC to energy saving mode (sleep mode)

Press the Up key to activate the sleep mode (YES) and turn off directly with the SET key.

Standard value: NO

The JETRONIC is automatically switched to sleep mode if the following is true for a period of at least 4 minutes:

- x No RC1 signal is present,
- x cooling down is finished and
- x no keys are pressed.

By switching the R/C transmitter on (RC1 signal), the JETRONIC is activated again. In sleep mode the current consumption is 1,3mA only, which is about 1 month by an battery charge of 1000mAh.

Airspeed Sensor [8135]

The JETRONIC-Vx allows the connection of an optional airspeed sensor to the AUXiliary connector. For the measurement, a pitot tube (Prandtl type) and an electronic pressure sensor are used. The tube is mounted on the outside of the model in flight direction and the sensor is mounted inside the model. The two components are connected via the two included pieces of tubing.

The measurement of the airspeed in flight allows several useful functions:

- Determining the (maximum) airspeed [km/h] (see INFO:15 AIRSPEED-PEAK)
- Determining the covered total distance [km] flown (see INFO:16 AIR-DISTANCE)
- Limiting the airspeed to a value allowed for the airframe model (always or switchable).

Installation

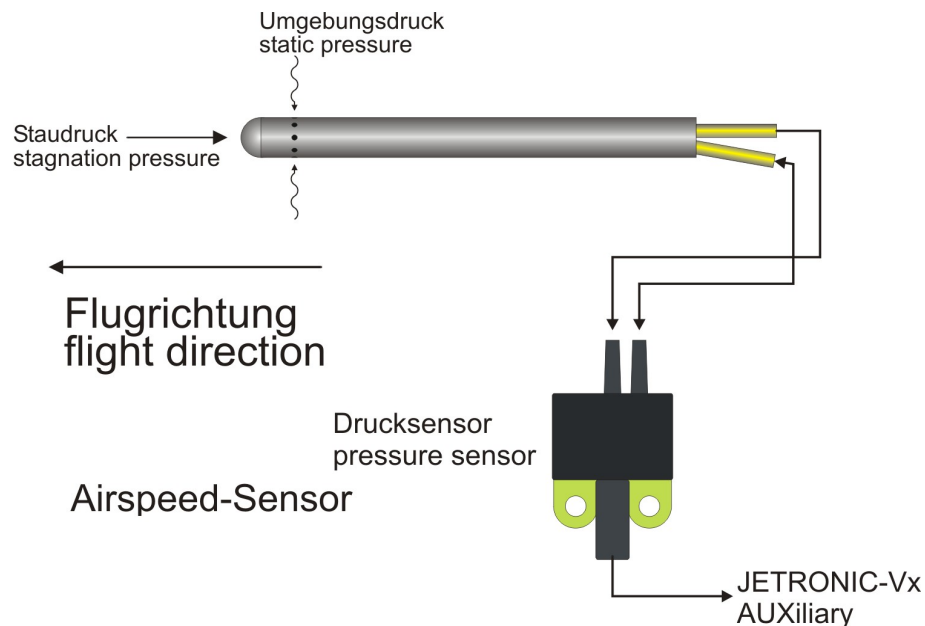

Activation

- ✓ Set R/C-SETTINGS:59 AUX-MODE to AIRSPEED.
- ✓ Set LIMITS:37 AIRSPEED-MAX to the desired speed in km/h.
- ✓ To use the AIRSPEED-LIMITER switchable on/off from the Radio, connect the Jetronic-input RC2 with the switch-channel at your R/C receiver and activate R/C-SETTINGS:54 RC2-MODE to the value AIRSPEED.

Hints

In order to achieve a precise airspeed measurement, the pitot tube should measure the stagnation pressure possibly free or only on parts that are parallel to the incoming airflow.

- x* Do not mount the tube on conical areas.
- x* Keep a minimum distance of 2.5 cm = 1 inch to a parallel surface.

For a more precise measurement, you can also mount two airspeed sensors, for example on the wing tips, which are connected in parallel using a V-cable.

