



October 21<sup>st</sup>, 2015

# Falcon 9 Launch Vehicle PAYLOAD USER'S GUIDE

Rev 2

**SPACEX**

Approved for Public Release

Cleared for Open Publication by Office of Security Review.

## TABLE OF CONTENTS

---

<b>1. Introduction</b>	<b>5</b>
1.1 User's Guide Purpose	5
1.2 Company Description	5
1.3 Falcon Program Overview	6
1.4 Falcon Launch Vehicle Safety	6
1.5 Falcon Reliability	7
1.6 Pricing	9
<b>2. Vehicles</b>	<b>10</b>
2.1 Falcon 9 Vehicle Overview	10
2.2 Structure and Propulsion	10
2.3 Retention, Release and Separation Systems	12
2.4 Avionics, and Guidance, Navigation and Control	12
2.5 Coordinate Frame	12
<b>3. Performance</b>	<b>14</b>
3.1 Available Injection Orbits	14
3.2 Mass-to-Orbit Capability	14
3.3 Mass Properties	15
3.4 Launch Windows	16
3.5 Flight Attitude	16
3.6 Orbit Insertion Accuracy	16
3.7 Separation Attitude and Accuracy	16
3.8 Multiple Payloads	17
3.9 Secondary Payloads	17
<b>4. Environments</b>	<b>18</b>
4.1 Transportation Environments	18
4.2 Temperature, Humidity and Cleanliness	18
4.3 Flight Environments	19
4.3.1 Loads	19
4.3.2 Sine Vibration	21
4.3.3 Acoustic	23
4.3.4 Shock	26
4.3.5 Radio Frequency	27
4.3.6 Fairing Internal Pressure	30
4.3.7 Payload Temperature Exposure during Flight	31
4.3.8 Free Molecular Heating	32
4.4 Environmental Compatibility Verification	32
<b>5. Interfaces</b>	<b>34</b>
5.1 Mechanical Interfaces	34
5.1.1 Payload Adapters and Separation Systems	34
5.1.2 Payload Fairing	36

5.2	Electrical Interfaces	37
5.2.1	Connectivity during Payload Processing and on Launch Pad	37
5.2.2	Falcon-to-Payload Command Interface	39
5.2.3	Timing Services	40
5.3	Interface Compatibility Verification Requirements	40
<b>6.</b>	<b>Facilities</b>	<b>41</b>
6.1	Cape Canaveral Air Force Station, Florida	41
6.1.1	CCAFS Personnel Accommodations	41
6.2	Vandenberg Air Force Base, California	43
6.2.1	VAFB Personnel Accommodations	44
6.3	Headquarters—Hawthorne, CA	46
6.4	Rocket Development Facility—McGregor, TX	47
6.5	Government Outreach and Legal Affairs—Washington, DC	47
<b>7.</b>	<b>Mission Integration and Services</b>	<b>48</b>
7.1	Contracting	48
7.2	Mission Management	48
7.3	Standard Services	49
7.4	Schedule	50
7.5	Customer Deliverables	51
<b>8.</b>	<b>Operations</b>	<b>53</b>
8.1	Overview and Schedule	53
8.2	Spacecraft Delivery and Transportation	53
8.3	Spacecraft Processing	54
8.4	Joint Operations and Integration	57
8.5	Launch Operations	58
8.5.1	Organization	58
8.5.2	Spacecraft Control Center	59
8.5.3	Launch Control	59
8.5.4	Rollout, Erection and Pad Operations	60
8.5.5	Countdown	60
8.5.6	Recycle and Scrub	60
8.6	Flight Operations	61
8.6.1	Liftoff and Ascent	61
8.6.2	Spacecraft Separation	61
8.6.3	Contamination and Collision Avoidance	61
8.6.4	Post Launch Reports	61
8.6.5	Disposal	61
8.7	Sample Mission Profile	62
<b>9.</b>	<b>Safety</b>	<b>64</b>
9.1	Safety Requirements	64
9.2	Hazardous Systems and Operations	64
9.3	Waivers	64

<b>10. Contact Information</b>	<b>65</b>
<b>11. Quick Reference</b>	<b>66</b>
11.1 List of Figures	66
11.2 List of Tables	67
11.3 List of Acronyms	67

## 1. INTRODUCTION

---

### 1.1 User's Guide Purpose

The Falcon launch vehicle user's guide is a planning document provided for customers of SpaceX (Space Exploration Technologies Corp.). This document is applicable to the Falcon vehicle configurations with a 5.2 m (17-ft) diameter fairing and the related launch service (Section 2.1).

This user's guide is intended for pre-contract mission planning and for understanding SpaceX's standard services. The user's guide is not intended for detailed design use. Data for detailed design purposes will be exchanged directly between a SpaceX customer and a SpaceX mission manager.

SpaceX reserves the right to update this user's guide as required. Future revisions are assumed to always be in process as SpaceX gathers additional data and works to improve its launch vehicle design.

### 1.2 Company Description

SpaceX offers a family of launch vehicles that improve launch reliability and increase access to space. The company was founded on the philosophy that simplicity, reliability and cost effectiveness are closely connected. We approach all elements of launch services with a focus on simplicity to both increase reliability and lower cost. The SpaceX corporate structure is flat and business processes are lean, resulting in fast decision-making and product delivery. SpaceX products are designed to require low-infrastructure facilities with little overhead, while vehicle design teams are co-located with production and quality assurance staff to tighten the critical feedback loop. The result is highly reliable and producible launch vehicles with quality embedded throughout the process.

Established in 2002 by Elon Musk, the founder of Tesla Motors, PayPal and the Zip2 Corporation, SpaceX has developed and flown the Falcon 1 light-lift launch vehicle, the Falcon 9 medium-lift launch vehicle, and Dragon, which is the first commercially produced spacecraft to visit the International Space Station. SpaceX is also developing the Falcon Heavy, a heavy-lift vehicle capable of delivering over 53 metric tons to orbit. Falcon Heavy's first flight is planned for 2016; it will be the most powerful operational rocket in the world by a factor of two.

SpaceX has built a launch manifest that includes a broad array of commercial, government and international customers. In 2008, NASA selected the SpaceX Falcon 9 launch vehicle and Dragon spacecraft for the International Space Station Cargo Resupply Services contract. NASA has also awarded SpaceX multiple contracts to develop the capability to transport astronauts to space.

SpaceX has state-of-the-art production, testing, launch and operations facilities. SpaceX design and manufacturing facilities are conveniently located near the Los Angeles International Airport. This location allows the company to leverage Southern California's rich aerospace talent pool. The company also operates cutting-edge propulsion and structural test facilities in Central Texas, along with launch sites in Florida and California, and the world's first commercial orbital launch site in development in South Texas.

### 1.3 Falcon Program Overview

Drawing on a history of prior launch vehicle and engine programs, SpaceX privately developed the Falcon family of launch vehicles. Component developments include first- and second-stage engines, cryogenic tank structures, avionics, guidance and control software, and ground support equipment.

With the Falcon 9 and Falcon Heavy launch vehicles, SpaceX is able to offer a full spectrum of medium- and heavy-lift launch capabilities to its customers (Figure 1-1). SpaceX operates Falcon launch facilities at Cape Canaveral Air Force Station, Kennedy Space Center, and Vandenberg Air Force Base and can deliver payloads to a wide range of inclinations and altitudes, from low Earth orbit to geosynchronous transfer orbit to escape trajectories for interplanetary missions. Future missions will also be flown from our commercial orbital launch site under development in South Texas.

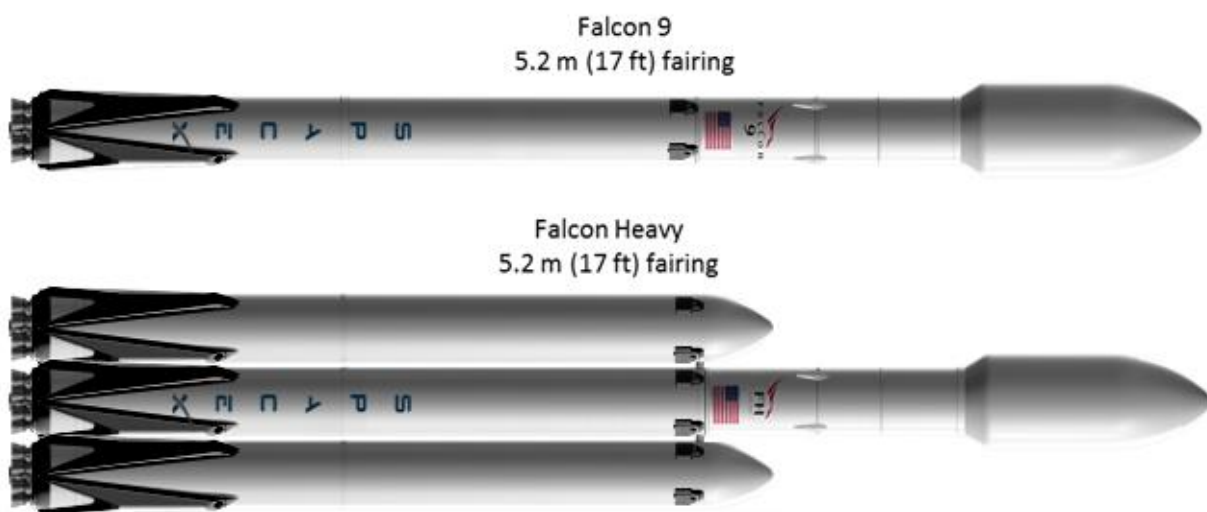

**Figure 1-1: SpaceX vehicles are designed for high cross-platform commonality**

Falcon 9 has conducted successful flights to the International Space Station (ISS), low Earth orbit (LEO), geosynchronous transfer orbit (GTO), and Earth-escape trajectories. A partial flight manifest for the Falcon program can be found at [www.spacex.com/missions](http://www.spacex.com/missions).

### 1.4 Falcon Launch Vehicle Safety

The Falcon launch vehicles were designed from the beginning to meet NASA human-rated safety margins. We continue to push the limits of rocket technology as we design the safest crew transportation system ever flown while simultaneously advancing toward fully reusable launch vehicles. Our emphasis on safety has led to advancements such as increased structural factors of safety (1.4 versus the traditional 1.25 for flight without crew), greater redundancy and rigorous fault mitigation. Because SpaceX produces one Falcon core vehicle, satellite customers benefit from the high design standards required to safely transport crew. The major safety features are listed in more detail in Table 1-1.

**Table 1-1: Falcon 9 safety features**

Design/Operations Feature	Safety Benefit
Designed to NASA human-rating margins and safety requirements	Improves reliability for payloads without crew through increased factors of safety, redundancy and fault mitigation
Horizontal manufacturing, processing and integration	Reduces work at height during numerous manufacturing, processing and integration procedures, and eliminates many overhead operations
All-liquid propulsion architecture; fuel and oxidizer are stored separately on the ground and in the vehicle. Propellant is not loaded into the vehicle until the vehicle is erected for launch	Significantly improves safety by eliminating hazardous ground handling operations required for systems that use solid propellant cores or boosters
Rocket-grade kerosene and liquid oxygen as primary propellants	Reduces health hazards to processing, integration, and recovery personnel compared to systems that use high toxicity primary propellants
Two-stage architecture	Reduced overall complexity reduces risk associated with fueling and operation of additional stages
Non-explosive, pneumatic release and separation systems	Zero-debris separation systems significantly reduce orbital debris signature, can be repeatedly tested during the manufacturing process, and eliminate hazardous pyrotechnic devices
Regular hardware-in-the-loop (HITL) software testing	Complete verification of entire mission profile prior to flight

## 1.5 Falcon Reliability

A study<sup>1</sup> by The Aerospace Corporation found that 91% of known launch vehicle failures in the previous two decades can be attributed to three causes: engine, avionics and stage separation failures. With this in mind, SpaceX incorporated key engine, avionics and staging reliability features for high reliability at the architectural level of Falcon launch vehicles. Significant contributors to reliability include:

- **Engines**

The Merlin engine that powers the Falcon family of launch vehicles is the only new hydrocarbon engine to be successfully developed and flown in the U.S. in the past 40 years. It has the highest thrust-weight of any boost engine ever made. The liquid-propellant Merlin powers the Falcon propulsion system. The engine features a reliable turbopump design with a single shaft for the liquid oxygen pump, the fuel pump and the turbine. The engine uses a gas generator cycle instead of the more complex staged combustion cycle. The regeneratively cooled nozzle and thrust

<sup>1</sup> Chang, I-Shih. "Space Launch Vehicle Reliability," *Aerospace Corporation Publication (2001)*.

chamber use a milled copper alloy liner that provides large heat flux margins. A pintle injector provides inherent combustion stability.

Engine failure modes are minimized by eliminating separate subsystems where appropriate. For example, the first-stage thrust vector control system pulls from the high-pressure rocket-grade kerosene system, rather than using a separate hydraulic fluid and pressurization system. Using fuel as the hydraulic fluid eliminates potential failures associated with a separate hydraulic system and with the depletion of hydraulic fluid.

The high-volume engine production required to fly 10 Merlin engines (Falcon 9) or 28 engines (Falcon Heavy) on every launch results in high product quality and repeatability through process control and continuous production. Flying several engines on each mission also quickly builds substantial engineering data and flight heritage.

During Falcon launch operations, the first stage is held on the ground after engine ignition while automated monitors confirm nominal engine operation. An autonomous safe shutdown is performed if any off-nominal condition is detected. Hold-on-pad operations, enabled by the launch vehicle's all-liquid propulsion architecture and autonomous countdown sequence, significantly reduce risks associated with engine start-up failures and underperformance.

By employing multiple first-stage engines, SpaceX offers the world's first evolved expendable launch vehicle (EELV)-class system with engine-out capability through much of first-stage flight. System-level vehicle management software controls the shutdown of engines in response to off-nominal engine indications. Although the likelihood of catastrophic engine failure is low, and failing engines are designed to be shut down prior to a catastrophic failure, each engine is housed within its own metal bay to isolate it from neighboring engines.

The second-stage Merlin Vacuum engine uses a fixed, non-deploying expansion nozzle, eliminating potential failure modes in nozzle extension.

- **Avionics**

Falcon launch vehicle avionics, and guidance, navigation and control systems use a fault-tolerant architecture that provides full vehicle single-fault tolerance and uses modern computing and networking technology to improve performance and reliability. The fault tolerance is achieved either by isolating compartments within avionics boxes or by using triplicated units of specific components. Both the first and second stages host their own multiple redundant lithium-ion batteries to minimize the complexity of the electrical interface.

- **Staging Architecture and Design**

The two-stage Falcon architecture was selected to minimize the number of stage separation events, eliminating potential failure modes associated with third- and fourth-stage separations, as well as potential engine deployment and ignition failure modes in the third and fourth stages.



The Falcon second-stage restraint, release and separation systems use pneumatic devices that provide low-shock release and positive force separation over a comparatively long stroke. The pneumatic system allows for acceptance and functional testing of the actual flight hardware, which is not possible with a traditional explosives-based separation system.

For each Falcon launch vehicle, SpaceX performs an exhaustive series of tests from the component to the vehicle system level. The test program includes component-level flight acceptance and workmanship testing, structures load and proof testing, flight system and propulsion subsystem-level testing, full first- and second-stage testing up to full system testing (including first- and second-stage static fire testing), as well as a static fire test on the launch pad. In addition to testing environmental extremes (plus margin), all hardware is tested to account for off-nominal conditions. For example, stage separation tests are performed for off-nominal cases with respect to geometrical misalignment, anomalous timing and sequencing.

The Falcon first stage is designed to survive atmospheric entry and to be recovered, handling both the rigors of the ascent portion of the mission and the loads of the recovery portion. Stage recoverability also provides a unique opportunity to examine recovered hardware and assess design and material selection in order to continually improve Falcon 9.

## 1.6 Pricing

The standard price for Falcon 9 launch services can be found at [www.spacex.com/about/capabilities](http://www.spacex.com/about/capabilities). Pricing includes range services, standard payload integration and third-party liability insurance. Please see Section 7.3 for a complete description of standard services. Nonstandard services are also available.

## 2. VEHICLES

### 2.1 Falcon 9 Vehicle Overview

Falcon 9 (Figure 2-1) is a two-stage launch vehicle powered by liquid oxygen (LOX) and rocket-grade kerosene (RP-1). The vehicle is designed, built and operated by SpaceX. Falcon 9 can be flown with a fairing or with a SpaceX Dragon spacecraft. All first- and second-stage vehicle systems are the same in the two configurations; only the payload interface to the second stage changes between the fairing and Dragon configurations.

As of summer 2015, Falcon 9 is upgraded from its previous v1.1 configuration (flown from 2013 – summer 2015). Unused margin on the engines has been released to increase thrust. The airframe and thrust structures have been reinforced to accommodate the additional thrust and increase reliability. The upgraded vehicle also includes first-stage recovery systems, to allow SpaceX to return the first stage to the launch site after completion of primary mission requirements. These systems include four deployable landing legs, which are locked against the first-stage tank during ascent. Excess propellant reserved for Falcon 9 first-stage recovery operations will be diverted for use on the primary mission objective, if required, ensuring sufficient performance margins for successful missions.

Descriptions and performance information in this user's guide are for the Falcon 9 fairing configuration; please contact SpaceX for information about Dragon launch capabilities. Table 2-1 provides additional details on Falcon 9 dimensions and design characteristics.

### 2.2 Structure and Propulsion

The first-stage propellant tank walls of the Falcon vehicles are made from an aluminum lithium alloy. Tanks are manufactured using friction stir welding—the highest strength and most reliable welding technique available.

On the first stage of the Falcon 9, an insulated common dome separates the LOX and RP-1 tanks, and an insulated transfer tube carries LOX through the center of the RP-1 tank to the engine section. Four grid fins near the top of the first stage along with four deployable legs are nominally flown at the base of the first stage to support recovery operations.

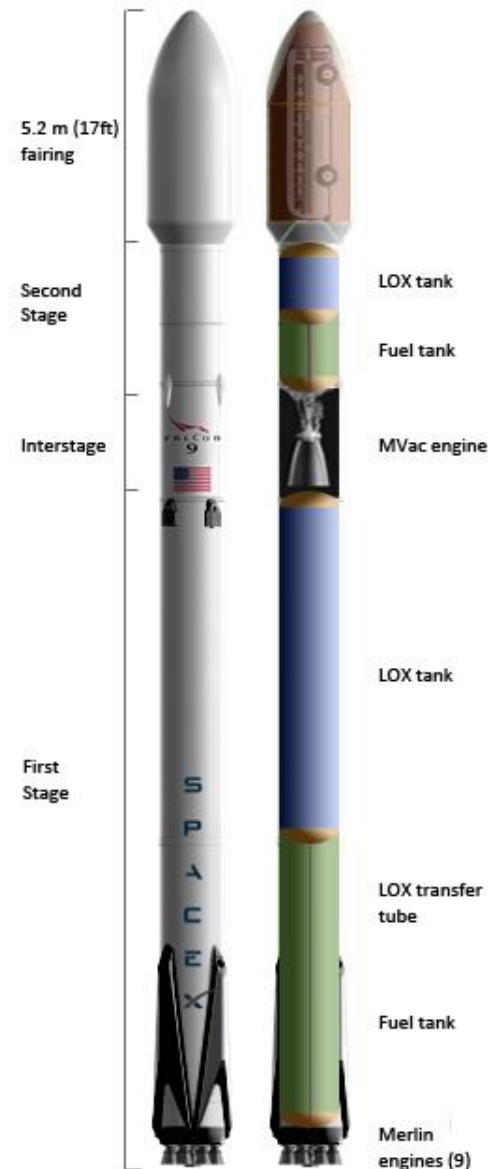

Figure 2-1 Falcon 9 Overview

Nine SpaceX Merlin engines power the Falcon 9 first stage with up to 756 kN (170,000 lbf) thrust per engine at sea level, for a total thrust of 6,804 kN (1.53 million lbf) at liftoff. The first-stage engines are configured in a circular pattern, with eight engines surrounding a center engine.

After engine start, Falcon vehicles are held down until all vehicle systems are verified as functioning normally before release for liftoff.

The Falcon vehicles' interstage, which connects the first and second stages, is a composite structure consisting of an aluminum honeycomb core surrounded by carbon fiber face sheet plies. The interstage is fixed to the forward end of the first-stage tank. The stage separation system is located at the forward end of the interstage and interfaces to the second-stage.

The second-stage tank for Falcon vehicles is a shorter version of the first-stage tank and uses most of the same materials, construction, tooling and manufacturing techniques as the first-stage tank. A single Merlin Vacuum (MVac) engine powers the second stage, using a fixed 165:1 expansion nozzle. For added reliability of restart, the engine contains dual redundant triethylaluminum-triethylborane (TEA-TEB) pyrophoric igniters. In addition, the second stage contains a cold nitrogen gas (GN<sub>2</sub>) attitude control system (ACS) for pointing and roll control. The GN<sub>2</sub> ACS is more reliable and produces less contamination than a propellant-based reaction control system.

**Table 2-1: Falcon 9 dimensions and characteristics**

Characteristic	First Stage	Second Stage
<b>Structure</b>		
Height	70 m (229 ft) (including both stages, interstage and fairing)	
Diameter	3.66 m (12 ft)	3.66 m (12 ft)
Type	LOX tank – monococque; Fuel tank – skin and stringer	LOX tank – monococque Fuel tanks – skin and stringer
Material	Aluminum lithium skin; aluminum domes	
<b>Propulsion</b>		
Engine type	Liquid, gas generator	Liquid, gas generator
Engine designation	Merlin 1D (M1D)	MVac
Engine designer	SpaceX	SpaceX
Engine manufacturer	SpaceX	SpaceX
Number of engines	9	1
Propellant	Liquid oxygen/kerosene (RP-1)	Liquid oxygen/kerosene (RP-1)
Thrust (stage total)	6,804 kN (sea level) (1,530,000 lbf)	934 kN (Vacuum) (210,000 lbf)
Propellant feed system	Turbopump	Turbopump
Throttle capability	Yes (170,000 lbf to 119,000 lbf sea level)	Yes (210,000 lbf to 81,000 lbf)
Restart capability	Yes	Yes
Tank pressurization	Heated helium	Heated helium
<b>Ascent attitude control</b>		
Pitch, yaw	Gimbaled engines	Gimbaled engine/nitrogen gas thrusters

Roll	Gimbaled engines	Nitrogen gas thrusters
Coast attitude control	Nitrogen gas thrusters (recovery only)	Nitrogen gas thrusters
<b>Operations</b>		
Shutdown process	Commanded shutdown	Commanded shutdown
Stage separation system	Pneumatically actuated separation mechanism	N/A

### 2.3 Retention, Release and Separation Systems

The first and second stages are mated by mechanical latches at three points between the top of the interstage and the base of the second-stage fuel tank. After the first-stage engine shut down, a high-pressure helium circuit is used to release the latches via redundant actuators. The helium system also preloads three pneumatic pushers, which provide positive-force stage separation after latch release. For added reliability, a redundant center pusher attached to the first stage is designed to dramatically decrease the probability of re-contact between the stages following separation.

The two halves of the fairing are fastened by mechanical latches along the fairing vertical seam. To deploy the fairing, a high-pressure helium circuit releases the latches, and four pneumatic pushers facilitate positive-force deployment of the two halves. The use of all-pneumatic separation systems provides a benign shock environment, allows acceptance and preflight testing of the actual separation system hardware, and minimizes debris created during the separation event.

### 2.4 Avionics, and Guidance, Navigation and Control

Falcon avionics feature a three-string, fault-tolerant architecture that has been designed to human-rating requirements. Avionics include flight computers, Global Positioning System (GPS) receivers, inertial measurement units, SpaceX-designed and manufactured controllers for vehicle control (propulsion, valve, pressurization, separation and payload interfaces), a network backbone, S-band transmitters and a C-band transponder for range safety tracking. The S-band transmitters are used to transmit telemetry and video to the ground, from both the first and second stages, even after stage separation.

Our launch vehicles are equipped with a flight termination system to limit the potential damage caused by a launch vehicle malfunction. The system terminates the flight of the vehicle either when commanded by the range mission flight control officer or automatically in the case of premature stage separation.

### 2.5 Coordinate Frame

Falcon vehicles use a right-hand X-Y-Z coordinate frame centered 440.69 cm (173.5 in.) aft of the first-stage radial engine gimbal, with +X aligned with the vehicle long axis and +Z opposite the transporter-erector strongback (Figure 2-2). X is the roll axis, Y is the pitch axis, and Z is the yaw axis. Additional coordinate frames may be defined with reference to the payload interface (Section 5.1.1) for specific missions.

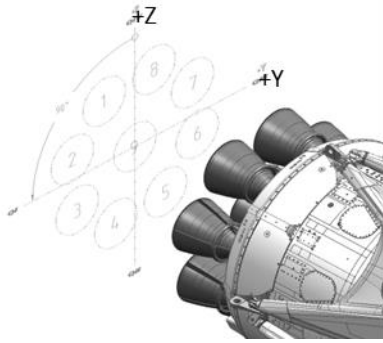

Figure 2-2: Falcon vehicle coordinate frame

### 3. PERFORMANCE

---

#### 3.1 Available Injection Orbits

SpaceX launch services are offered at its Cape Canaveral Air Force Station, Vandenberg Air Force Base and Kennedy Space Center launch sites. An additional launch site is currently under development in South Texas (Section 6).

Table 3-1 describes the typical injection orbits available from our operational launch sites. (As other launch sites are activated, this User's Guide will be updated.)

**Table 3-1: Falcon 9 launch services**

Insertion Orbit	Inclination Range	Vehicle	Launch Site(s)	Mass Capability
LEO	28.5 – 51.6 deg	Falcon 9 or Falcon Heavy	Cape Canaveral	Contact SpaceX for performance details.
LEO polar/sun-sync	66 – 145 deg	Falcon 9 or Falcon Heavy	Vandenberg	
GTO	Up to 28.5 deg	Falcon 9 or Falcon Heavy	Cape Canaveral	
Earth escape	N/A	Falcon 9 or Falcon Heavy	Cape Canaveral, Vandenberg	

Launch services to a range of low Earth orbits are available, including services to low-inclination orbits through high-inclination, sun-synchronous orbits. Falcon 9 can provide either two-burn or direct-inject launch services: two-burn mission profiles optimize vehicle performance, while direct-inject mission profiles offer reduced mission duration and require only a single start of the second-stage engine. LEO missions to a 51.6 deg inclination or lower are flown from Cape Canaveral Air Force Station; LEO missions to higher inclinations are flown from Vandenberg Air Force Base. Launch services to inclinations lower than 28.5 deg are available from Cape Canaveral, but they incur a performance penalty.

Launch services to a range of geosynchronous transfer orbits and other high-altitude orbits are available, including standard GTO, sub-GTO for heavy payloads, and supersynchronous injection. A perigee altitude of 185 km (100 nmi) is baselined for GTO; higher perigee values may be provided with a performance penalty. Currently, all GTO missions are flown from Cape Canaveral.

Launch services to a range of Earth escape orbits are available. Customers may also utilize a customer-supplied kick-stage to achieve higher escape energy (C3) performance, based on mission requirements. Earth escape missions are typically flown from Cape Canaveral.

#### 3.2 Mass-to-Orbit Capability

Mass-to-orbit capabilities for the Falcon 9 fairing configuration are available upon request.

### 3.3 Mass Properties

The payload attach fitting (PAF) converts the diameter of the launch vehicle to the standard 1575-mm (62.01 in.) bolted interface (Figure 3-1). SpaceX uses one of two PAFs on the launch vehicle, based on payload mass. The light PAF can accommodate payloads weighing up to 3,453 kg (7,612 lb), while the heavy PAF can accommodate up to 10,886 kg (24,000 lb). Payloads must comply with the mass properties limitations given in Figure 3-2. Payload mass properties should be assessed for all items forward of the payload attach fitting 1575-mm (62.01 in.) bolted interface (Section 5.1.1), including any mission-unique payload adapters and separation systems. Mass property capabilities may be further constrained by mission-unique payload adapters, dispensers or separation systems.

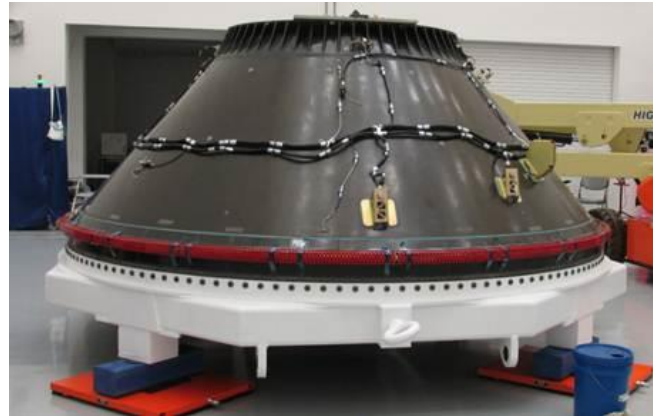

Figure 3-1: SpaceX payload attach fitting

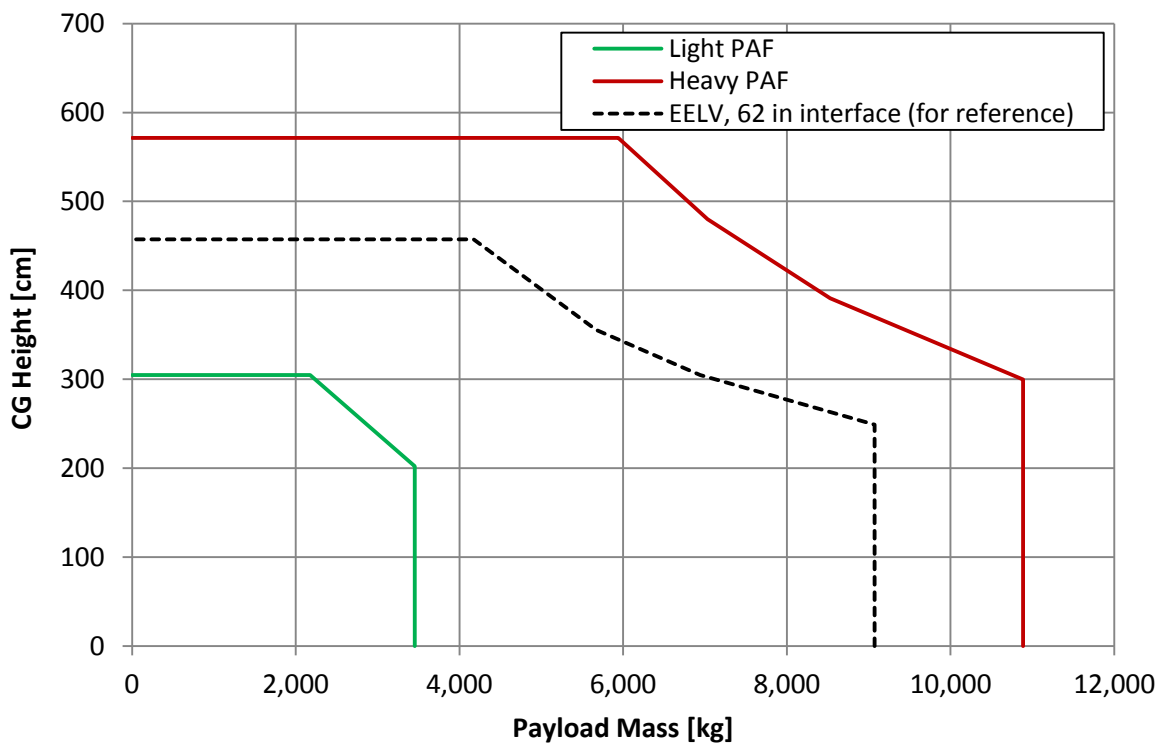

Figure 3-2: Maximum allowable center-of-gravity height above the 1575-mm plane

SpaceX requires that customers verify the mass properties of their system through measurement before shipping it to the launch site, and the company may request insight into relevant analyses and testing performed. Falcon 9 may be able to accommodate payloads with characteristics outside the limitations indicated in this section. Please contact SpaceX with your mission-unique requirements.

### 3.4 Launch Windows

Falcon launch vehicles can launch any day of the year, at any time of day, subject to environmental limitations and constraints as well as range availability and readiness. Launch window times and durations are developed specifically for each mission; accommodating customer requirements for launch windows longer than 4 hours or shorter than 1 hour is considered a nonstandard service. Customers benefit from recycle operations, maximizing launch opportunities within the launch window (Section 8.5.6).

### 3.5 Flight Attitude

Falcon 9 can provide payload pointing and roll control during long-duration coast phases for sun avoidance and thermal control. If requested, the Falcon 9 second stage will point the X-axis of the launch vehicle to a customer-specified attitude and perform a passive thermal control roll of up to  $\pm 1.5$  deg/sec around the launch vehicle X-axis, held to a local vertical/local horizontal (LVLH) roll attitude accuracy of  $\pm 5$  deg.

### 3.6 Orbit Insertion Accuracy

Falcon 9 is designed to achieve the orbit insertion accuracies listed in Table 3-2. Accuracies shown are for osculating elements at orbit insertion. Improved orbit insertion accuracy can be provided as a nonstandard service.

**Table 3-2: Orbit insertion accuracy**

Mission Type	Perigee	Apogee	Inclination	RAAN <sup>2</sup>	Arg. Perigee
LEO direct inject (200 km x 360 km)	$\pm 10$ km $3\sigma$	$\pm 15$ km $3\sigma$	$\pm 0.1$ deg $3\sigma$	$\pm 0.1$ deg $3\sigma$	N/A
Geosynchronous transfer orbit (185 km x 35,786 km)	$\pm 10$ km $3\sigma$	$\pm 500$ km $3\sigma$	$\pm 0.1$ deg $3\sigma$	$\pm 0.1$ deg $3\sigma$	$\pm 0.3$ deg $3\sigma$

### 3.7 Separation Attitude and Accuracy

Falcon 9 offers 3-axis attitude control or spin-stabilized separation as a standard service. For inertial separation, Falcon 9 will point the second stage and payload to the desired LVLH attitude and minimize attitude rates. For spin-stabilized separation, Falcon 9 will point the second stage and payload to the desired LVLH attitude and initiate a spin about the launch vehicle X-axis at a customer-specified rate, up to 30 deg/sec (5 RPM) dependent upon payload mass properties. Standard pre-separation attitude and rate accuracies are developed as a mission-specific standard service. More information about separation attitude and rate accuracy is available from SpaceX upon request.

<sup>2</sup> Right ascension of ascending node (RAAN) accuracy is shown here accounting for launch vehicle insertion accuracy only, and it assumes an instantaneous launch window, which is a nonstandard service. For a standard-service, 1-hour launch window, RAAN accuracy will be dominated by launch time uncertainty within the window, and it will be of order  $\pm 7.5$  degrees (or  $\pm 30$  minutes, if expressed in terms of local time of ascending node (LTAN)).



### 3.8 Multiple Payloads

Falcon 9 can launch multiple satellites on a single mission, with the customer responsible for the integration of the multiple payloads. As a liquid-propellant launch vehicle with restart capability, Falcon 9 also provides the flexibility to deploy each satellite into a different orbit, performance allowing.

Falcon 9 can accommodate a broad range of dispenser systems including multi-payload systems, dual-payload attach fittings and mission-unique adapters. SpaceX can develop and provide such adapters and dispensers if desired, as a nonstandard service, or can integrate third-party systems. Please contact SpaceX with your mission-unique requirements.

### 3.9 Secondary Payloads

SpaceX typically reserves the right to manifest secondary payloads aboard Falcon missions on a non-interference basis. Secondary payloads may be manifested on a variety of secondary payload adapters including an Evolved Expendable Launch Vehicle (EELV) Secondary Payload Adapter (ESPA) ring, a SpaceX-developed Surfboard, or other mission-unique secondary deployment structures.

Please contact SpaceX or a secondary payload broker for information regarding flight opportunities, interface requirements and pricing for secondary payloads.

## 4. ENVIRONMENTS

Falcon 9 has been designed to provide as benign a payload environment as possible, via the use of all-liquid propulsion, a single staging event, deeply throttleable engines and pneumatic separation systems. The environments presented below reflect typical mission levels for a Falcon 9; mission-specific analyses will be performed and documented in an interface control document for each contracted mission.

### 4.1 Transportation Environments

SpaceX recommends using the quasi-static limit load factors provided by NASA-HDBK-7005 (Table 4-1). SpaceX has quantified the maximum predicted environments experienced by the payload during transportation. Transportation will be accomplished by two wheeled vehicles: a payload transporter from the payload processing facility to the hangar, and the launch vehicle transporter-erector from the hangar to the launch pad. It is expected that transportation environments will be enveloped by the flight environments in Section 4.3.

**Table 4-1: Recommended quasi-static load factors for transportation**

Transportation Method	Longitudinal Load (g)	Lateral Load (g)	Vertical Load (g)
Slow-moving dolly (expected ground transport loads)	± 1.0	± 0.75	± 2.0

### 4.2 Temperature, Humidity and Cleanliness

The standard service temperature, humidity and cleanliness environments during various processing phases are provided in Table 4-2. SpaceX can accommodate environments outside the standard service, e.g. ISO Class 7 (Class 10,000) cleanroom cleanliness. Please contact SpaceX for details.

Conditioned air will be disconnected for a short duration during rollout to the pad. Spacecraft environmental temperatures will be maintained above the dew point of the supply air at all times. A nitrogen purge is available as a nonstandard service. The payload attach fitting (PAF) and fairing surface are cleaned to Visibly Clean-Highly Sensitive, achieving a residue level between A/5 and A/2 and particulate between 300-500 micron, per IEST-STD-CC1246D.

**Table 4-2: Temperature and cleanliness environments**

Phase	Control System	Approx. Duration	Temp. °C (°F)	Humidity	Cleanliness (class)	Flow Rate (cfm)
Spacecraft processing	Payload processing facility heating, ventilation and air conditioning (HVAC)	3 weeks	21 ± 3 (70 ± 5)	50% ± 15%	100,000	N/A

Propellant conditioning	Facility heating, ventilation and air conditioning (HVAC)	3 days	21 ± 3 (70 ± 5)	50% ± 15%	100,000 (Class 8)	N/A
Spacecraft propellant loading	Facility heating, ventilation and air conditioning (HVAC)	Mission-Unique	21 ± 3 (70 ± 5)	50% ± 15%	100,000 (Class 8)	N/A
Transport to hangar (CCAFS only)	Transport trailer unit	<2 hrs	21 ± 3 (70 ± 5)	0%-60%	10,000 (Class 7) (supply air cleanliness)	1,000
Encapsulated in hangar	Ducted supply from hangar facility HVAC	1 week	21 ± 3 (70 ± 5)	50% ± 15%	10,000 (Class 7) (supply air cleanliness)	1,000
Encapsulated roll-out to pad	None	30-60 min	N/A	N/A	10,000 (Class 7)	
Encapsulated on pad (vertical or horizontal)	Pad air conditioning	1 day	VAFB: Selectable 15 to 35 (59 to 95) CCAFS: Selectable 16 to 30 (61 to 86)	Selectable: 0% to 65%	10,000 (Class 7) (supply air cleanliness)	1,500

### 4.3 Flight Environments

The maximum predicted environments the payload will experience from liftoff through separation are described in the sections below. Falcon vehicles may be able to accommodate payloads with characteristics outside the limitations indicated in these sections and may also be able to provide environments lower than those indicated in these sections. Please contact SpaceX with your mission-unique requirements.

#### 4.3.1 Loads

During flight, the payload will experience a range of axial and lateral accelerations. Axial acceleration is driven by vehicle thrust and drag profiles; lateral acceleration is primarily driven by wind gusts, engine gimbal maneuvers, first-stage engine shutdown and other short-duration events.

Both the first- and second-stage engines may be throttled to help maintain launch vehicle and payload steady state acceleration limits.

Falcon 9 payload design load factors are shown using the envelopes in Figure 4-1 and Figure 4-2. Two sets of factors are given, one for “standard” payloads with mass of more than 4,000 lb (1,810 kg), and another for “light” payloads with mass of less than 4,000 lb (1,810 kg). A positive axial value indicates a compressive net-center-of-gravity acceleration, while a negative value indicates tension. Actual payload loads, accelerations and deflections are a function of both the launch vehicle and payload structural dynamic properties and can be accurately determined via a coupled loads analysis.

**4.3.1.1 Loads—Standard Payload Mass**

The design load factors provided here are expected to be conservative for payloads with the following basic characteristics: a fundamental bending mode greater than 10 Hz, a fundamental axial mode greater than 25 Hz, a maximum center of gravity (CG) height of 180 in, maximum lateral CG offset of 5 in, and a mass between 4,000 and 20,000 lb (1,810 – 9,070 kg). Payloads outside of this frequency and mass range can be accommodated. Please contact SpaceX for more details.

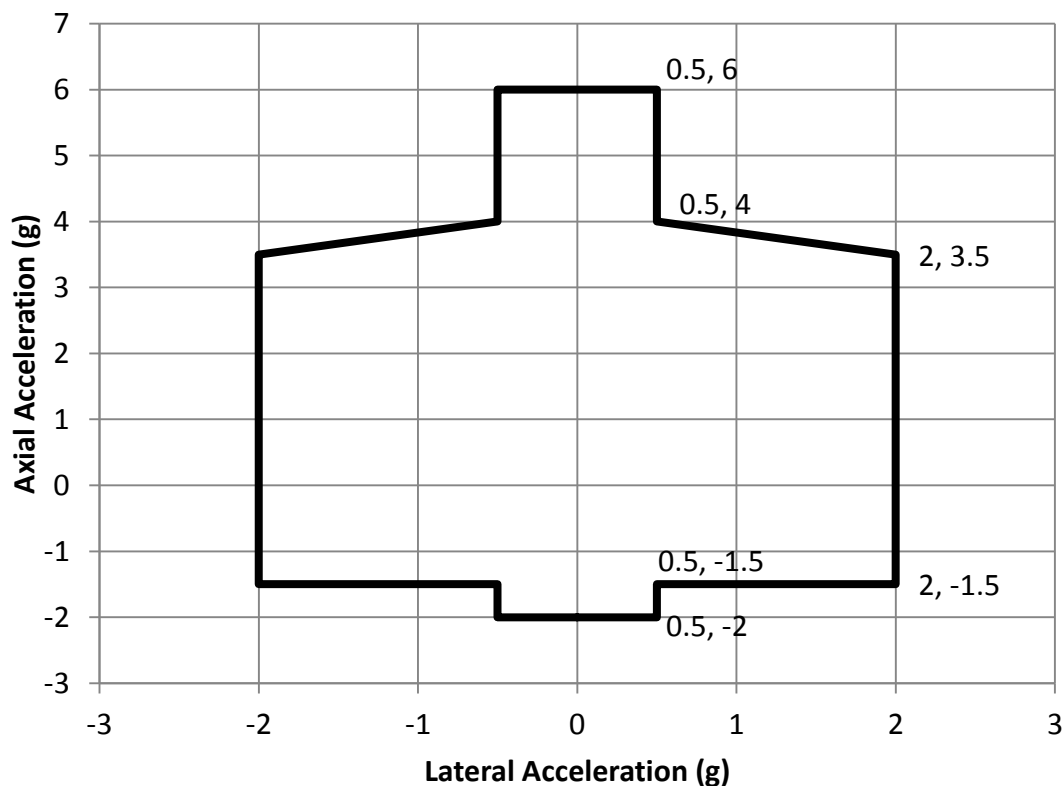

**Figure 4-1: Falcon 9 payload design load factors for “standard” mass (over 4,000 lb)**

**4.3.1.2 Loads—Light Payload Mass**

Figure 4-2 shows the design load factors for lighter payloads (less than 4,000 lb). However, for ultra-light payloads (~2,000 lb or less), coordination with SpaceX mission management is required, since these load factors may not be adequate to design the payload. Actual spacecraft loads, accelerations and deflections are a function of both the launch vehicle and payload structural dynamic properties and can only be accurately determined via a coupled loads analysis.

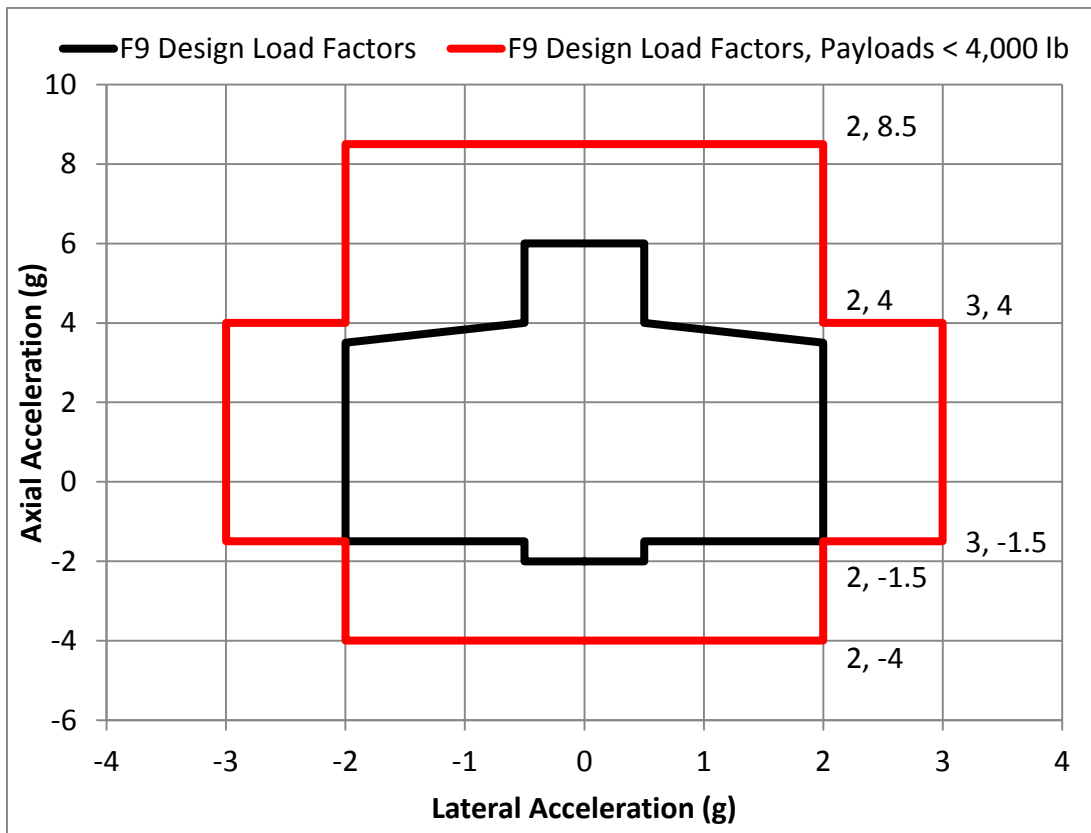

Figure 4-2: Falcon 9 payload design load factors, Light mass (under 4,000 lb)

### 4.3.2 Sine Vibration

Maximum predicted Falcon 9 sinusoidal vibration environments are shown in Figure 4-3 and Figure 4-4. These environments represent the vibration levels at the top of the payload attach fitting for Q=20 through Q=50, and envelope all stages of flight. Since SpaceX accommodates a variety of payloads, results of coupled loads analysis will be used to modify these levels, if necessary, to reflect the levels at the payload interface.

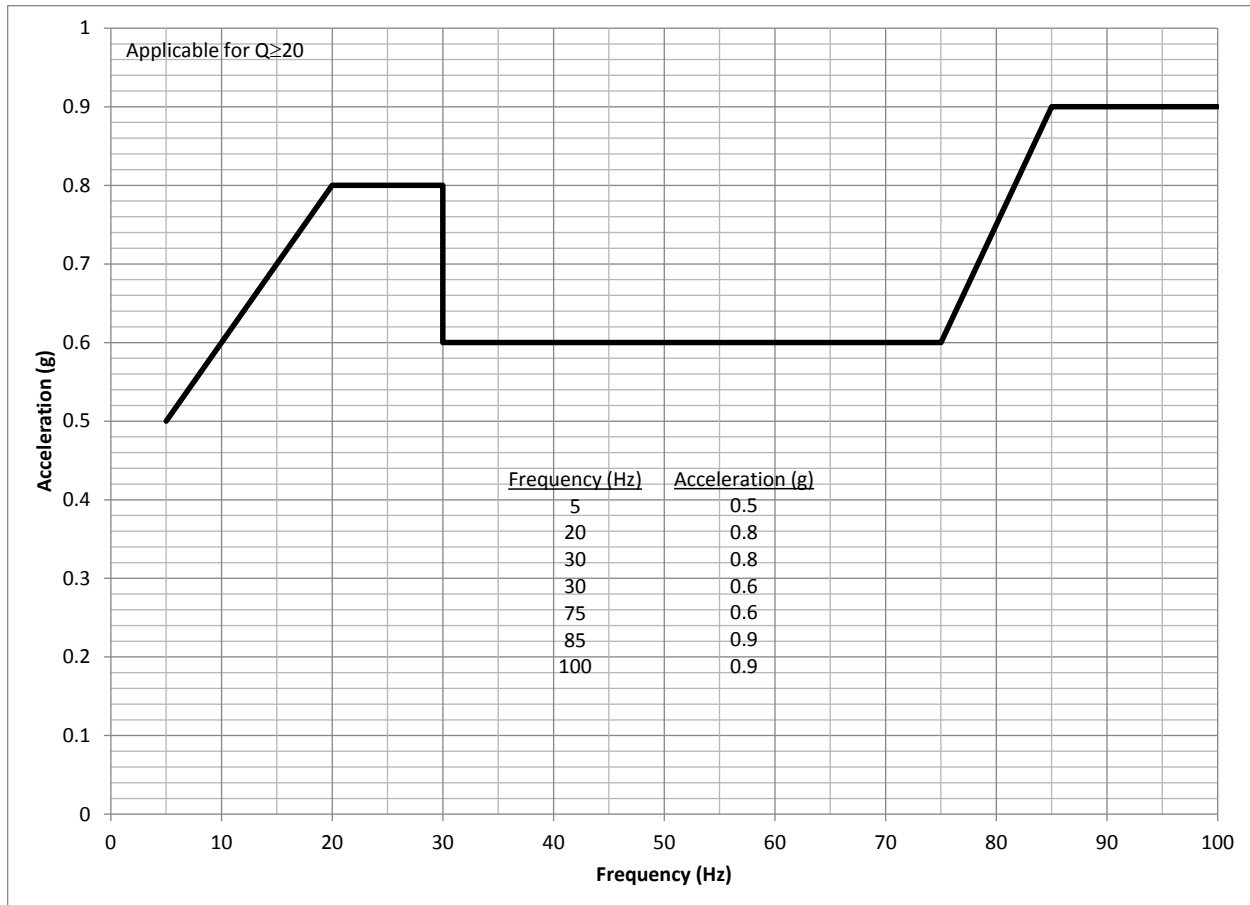
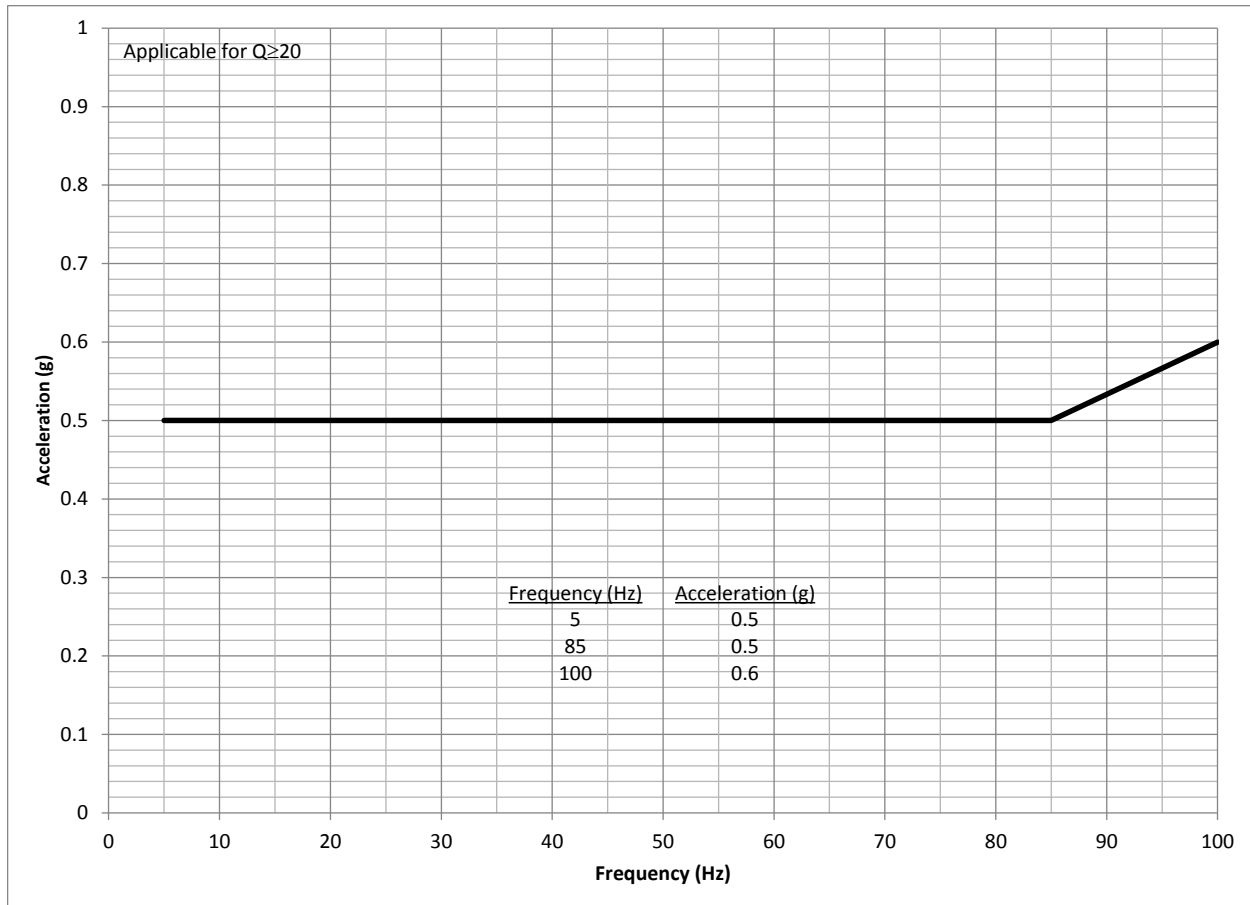

Figure 4-3: Falcon 9 maximum axial equivalent sine environment



**Figure 4-4: Falcon 9 maximum lateral equivalent sine environment**

### 4.3.3 Acoustic

During flight, the payload will be subjected to a varying acoustic environment. Levels are highest near liftoff and during transonic flight, due to aerodynamic excitation. The acoustic environment is shown by both full and third-octave curves. Figure 4-5 and Table 4-3 provide the third-octave maximum predicted acoustic environment for typical payloads, while Figure 4-6 and Table 4-4 provide the full-octave maximum predicted acoustic environment. Predicted acoustic levels for a specific mission will depend on the payload's size and volume with smaller payloads generally having lower acoustic levels. Margin for qualification testing is not included in the curves below.

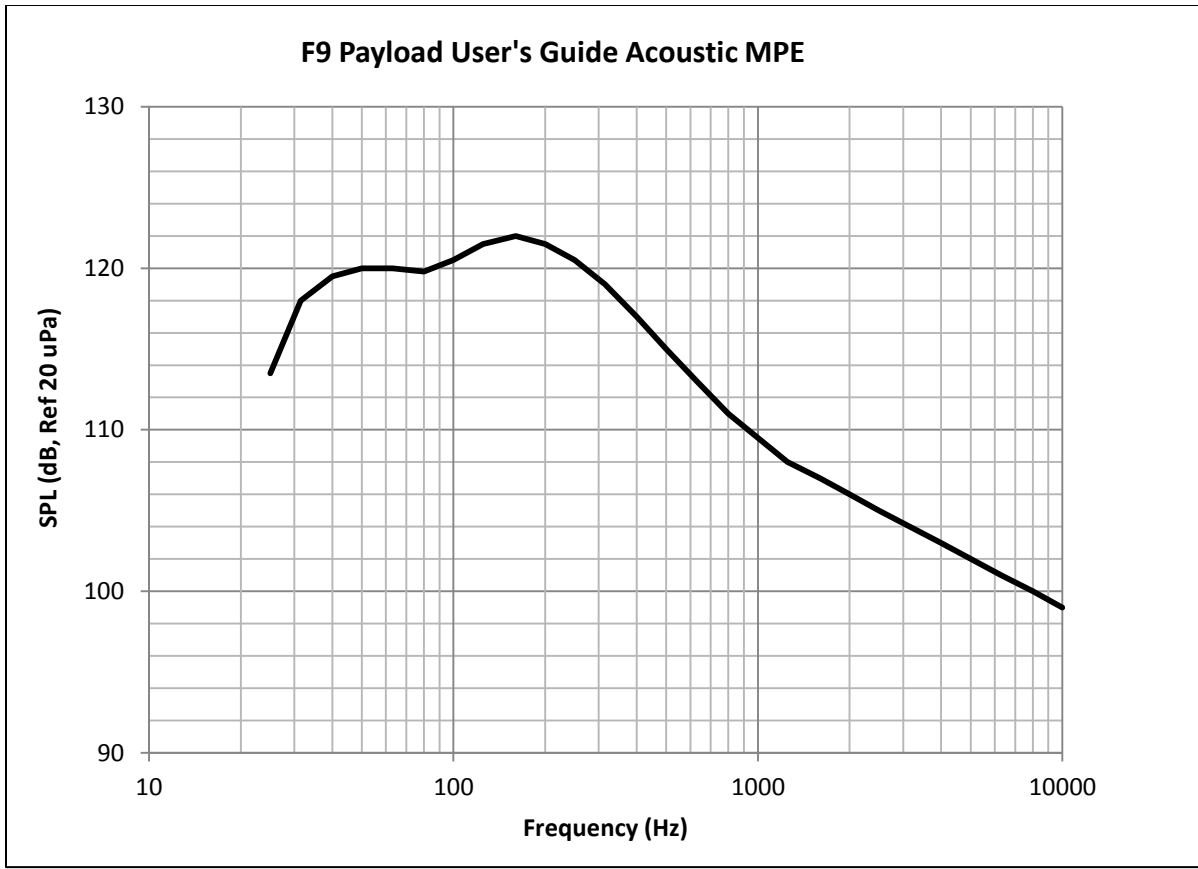

Figure 4-5: Falcon 9 maximum predicted acoustic environment (P95/50), 60% fill-factor, 131.4 dB OASPL (1/3 octave)

Table 4-3: Falcon 9 maximum predicted acoustic environment (P95/50), 60% fill-factor, 131.4 dB OASPL (1/3 octave)

Frequency (Hz)	Acoustic Limit Levels (P95/50), 60% Fill-Factor (1/3 Octave)
25	113.5
31.5	118
40	119.5
50	120
63	120
80	119.8
100	120.5
125	121.5
160	122
200	121.5
250	120.5



315	119
400	117
500	115
630	113
800	111
1000	109.5
1250	108
1600	107
2000	106
2500	105
3150	104
4000	103
5000	102
6300	101
8000	100
10000	99
<b>OASPL (dB)</b>	<b>131.4</b>

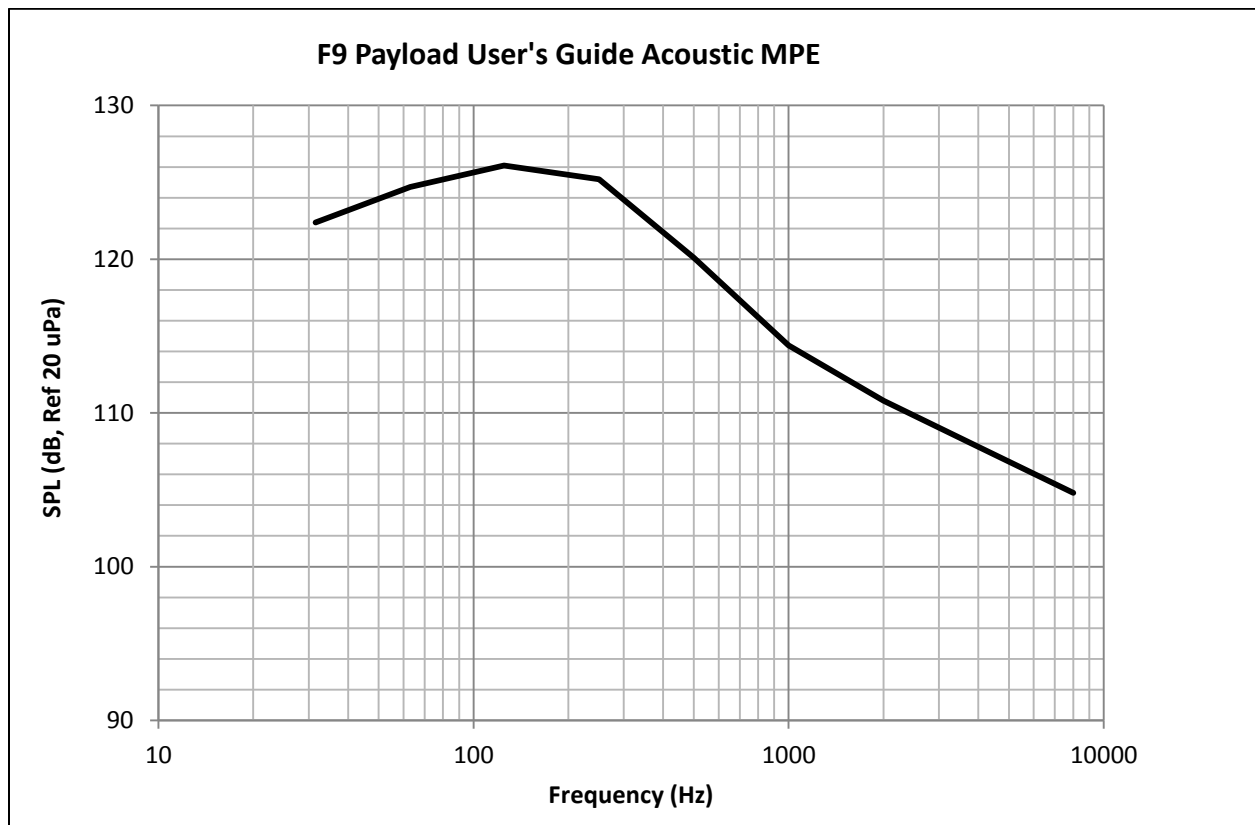

**Figure 4-6: Falcon 9 maximum predicted acoustic environment (P95/50), 60% fill-factor, 131.4 dB OASPL (full octave)**

**Table 4-4: Falcon 9 maximum predicted acoustic environment (P95/50), 60% fill-factor, 131.4 dB OASPL (full octave)**

Frequency (Hz)	Acoustic Limit Levels (P95/50), 60% Fill-Factor, (Full Octave)
31.5	122.4
63	124.7
125	126.1
250	125.2
500	120.1
1000	114.4
2000	110.8
4000	107.8
8000	104.8
<b>OASPL (dB)</b>	<b>131.4</b>

#### 4.3.4 Shock

Four events during flight result in loads that are characterized as shock loads:

- 1) Release of the launch vehicle hold-down at liftoff
- 2) Stage separation
- 3) Fairing deployment
- 4) Spacecraft separation

Of these events, the first two are negligible for the payload relative to fairing deployment and spacecraft separation because of the large distance and number of joints over which the shocks will travel and dissipate. The maximum shock environment predicted at the 1575-mm interface for fairing deployment is enveloped by the shock environment from typical spacecraft separation. Consequently, the shock environment is typically a function of the spacecraft adapter and separation system selected for the mission. Actual shock environments experienced by the payload at the top of the mission-unique payload adapter will be determined following selection of a specific payload adapter and separation system. Table 4-5 shows typical payload adapter-induced shock at the spacecraft separation plane for 937-mm or 1194-mm (36.89 in. or 47.01 in.) clampband separation systems. Please note the actual flight shock levels produced by the payload adapter will be mission-unique.

**Table 4-5: Payload adapter-induced shock at the spacecraft separation plane**

Frequency (Hz)	SRS (g)
100	30
1000	1,000
10000	1,000

### 4.3.5 Radio Frequency

Falcon launch vehicles include seven radio frequency (RF) systems, with a total of eleven channels (Table 4-6).

**Table 4-6: RF systems characteristics**

Part Description	Part Number	TX/RX	Frequency (MHz)	Output Power / De-sense Power (dBm)	99% Bandwidth (MHz)	Modulation	Gain in direction of PL (dBi)
S1TX1 Telemetry Transmitter	00049253-501	TX	2221.5	44.77	3	PCM/FM	4.44
S1TX2 Telemetry Transmitter	00049253-505		2273.5				
S2TX1 Telemetry Transmitter	00049253-503		2213.5				
S2TX2 Telemetry Transmitter	00049253-507		2251.5				
GPS Receiver	00025920-501	RX	1575.42	-100	20	BPSK DSSS	-0.20
UHF Command Receiver	CR-123	RX	421	-109	0.36	FM	-1.00
C-band Transponder		TX	5765	58.45 (peak)	CW	Pulse	5.21
C-band Transponder	SX-MD400-C	RX	5690	-75	CW	Pulse	5.21
Iridium/GPS Tracker		TX	1610 - 1626.5	32	0.042	BPSK/QPSK	-1.00
Iridium/GPS Tracker		RX	1610 - 1626.5	-117	0.042	QPSK	-1.00
Iridium/GPS Tracker	00041014-501	RX	1575.42	-100	20	BPSK DSSS	-1.00
S-Band BPSK Receiver	00103608-503	RX	2090 - 2093	-110	1	BPSK	-1.62
Radar Altimeter		TX	4250 - 4350	30	100	IFMCW	-17.12
Radar Altimeter	4503-1	RX	4250 - 4350	-126	100	IFMCW	-17.12

Note: Transmit for Iridium and Radar Altimeter only active during stage recovery operations

Payload customers must ensure that payload materials or components sensitive to RF environments are compatible with the worst-case Falcon launch vehicle radiated environment (Figure 4-7 and Table 4-7) and the worst-case range radiated environment of 10 V/m at all frequencies and 40 V/m between 5600 and 5900 MHz.

Falcon 9's radiated susceptibility is shown in Figure 4-8 and Table 4-8. Payloads may not emit radiation in excess of Falcon 9 susceptibility at any time during processing, integration or flight, as measured at the top of the payload attach fitting. Standard Falcon 9 services do not permit active payload radiation during the countdown or flight prior to separation from the second stage.

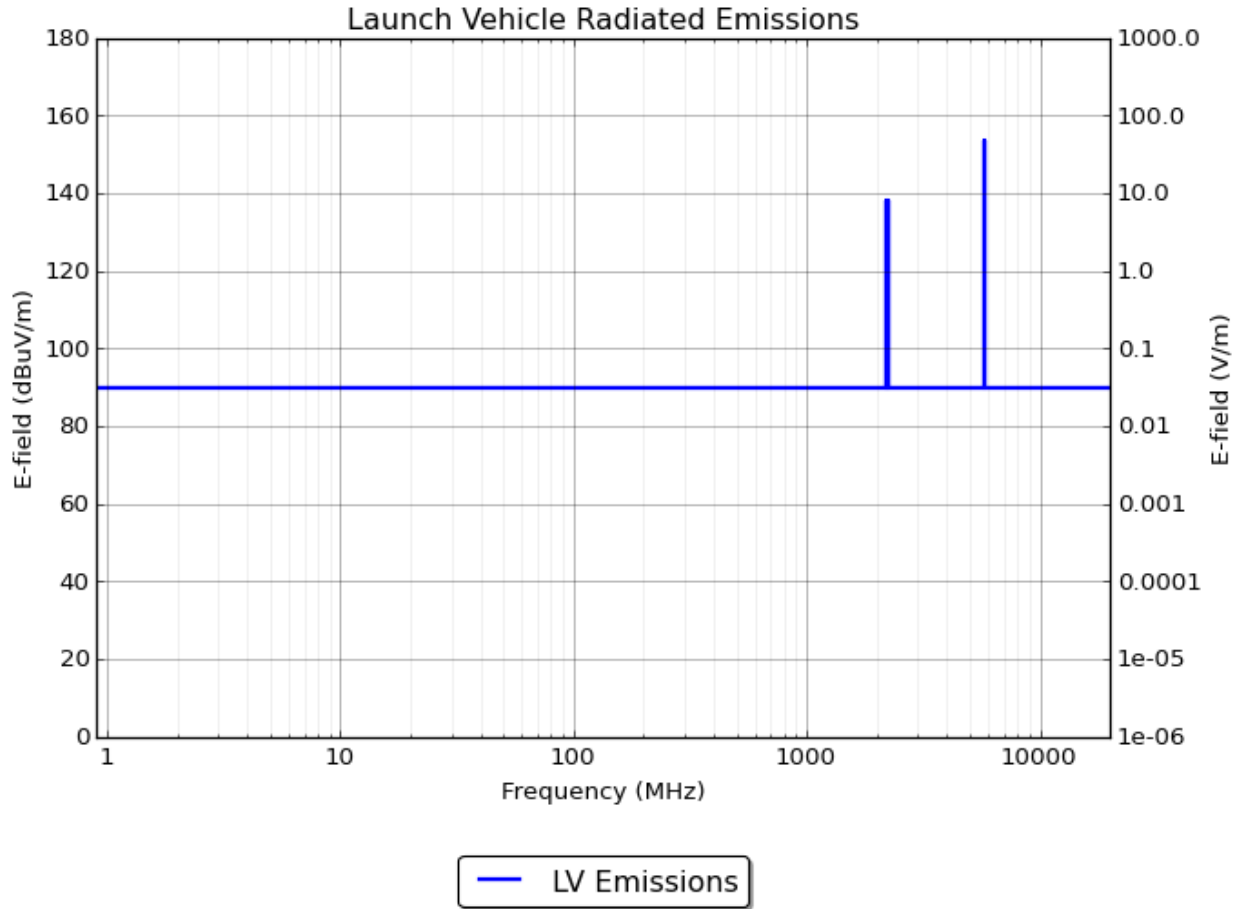

Figure 4-7: Falcon 9 worst-case radiated environment

Table 4-7: Falcon 9 worst-case radiated environment

Frequency Range (MHz)	E Field Limit (dBμV/m)	Launch Vehicle Transmit System
1.00 – 2200.0	90	
2200.0 – 2300.0	140	S-band telemetry and video
2300.0 – 5755.0	90	
5755.0 – 5775.0	154	C-band radar transponder
5775.0 – 18000.0	90	

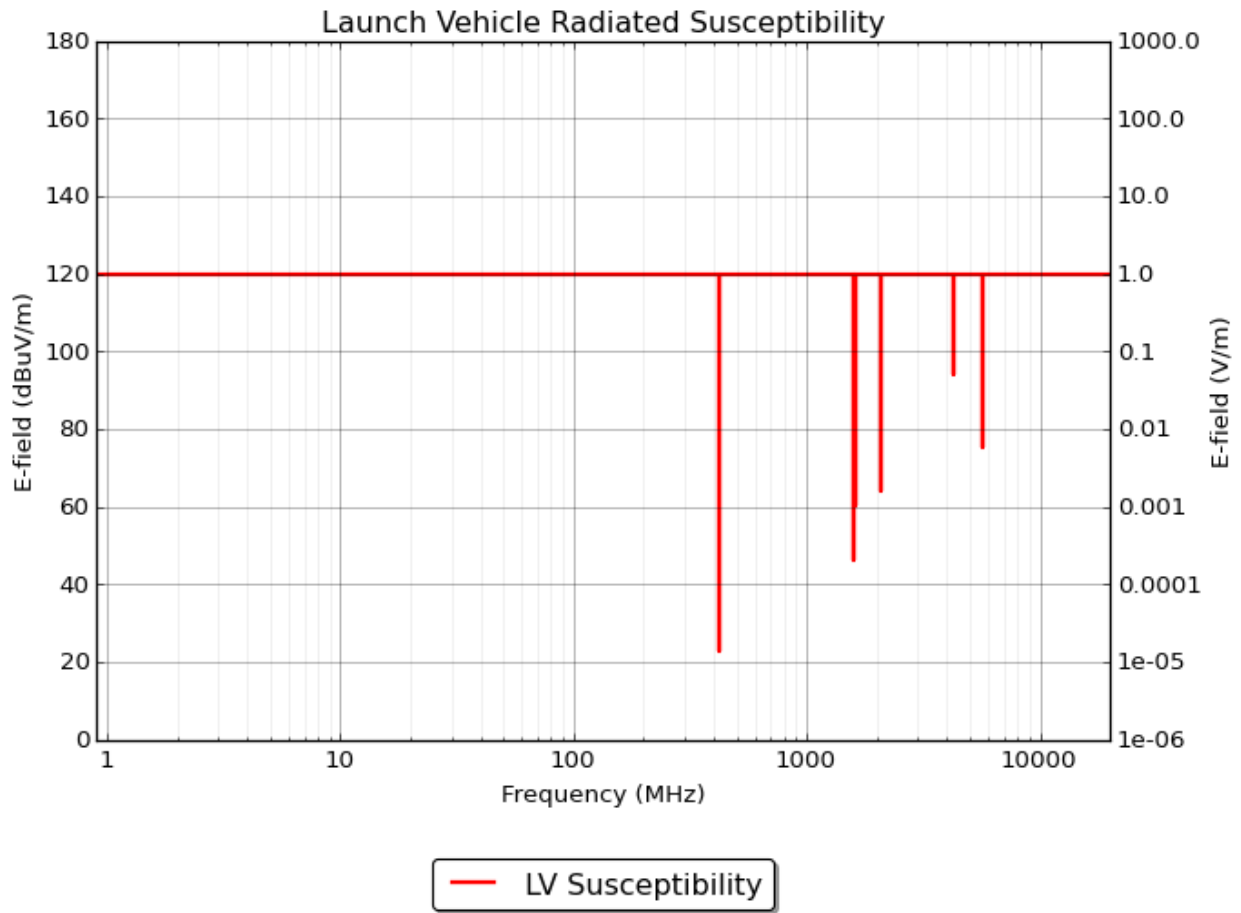

Figure 4-8: Falcon 9 RF susceptibility

Table 4-8: Falcon 9 RF susceptibility

Frequency Range (MHz)	E Field Limit (dBμV/m)	Launch Vehicle Receive System
1.0 – 410.0	120.0	
410.0 – 430.0	22.0	UHF Command Destruct
430.0 – 1565.0	120.0	
1565.0 – 1585.0	46.0	GPS L1
1585.0 – 1610.0	120.0	
1610.0 – 1630.0	60.0	Iridium
1630.0 – 2091.5	120.0	
2091.5 – 2093.0	66.0	Telecommand
2093.0 – 4250.0	120.0	
4250.0 – 4350.0	93.0	Radar Altimeter

4350.0 – 5680.0	120	
5680.0 – 5700.0	75.0	C-band radar transponder
5700.0 – 18000.0	120.0	

### 4.3.6 Fairing Internal Pressure

Inside the Falcon launch vehicle, the payload fairing internal pressure will decay at a rate no higher than 0.35 psi/sec (2.4 kPa/sec) from liftoff through immediately prior to fairing separation, except for a brief period during the transonic spike. The transonic spike will have a time-averaged decay rate that is no higher than 0.65 psi/sec (4.5 kPa/sec), for no more than 5 seconds. Typical pressure profiles and decay rates, expected to bound a broad range of payload fill factors, are shown in Figure 4-9 and Figure 4-10.

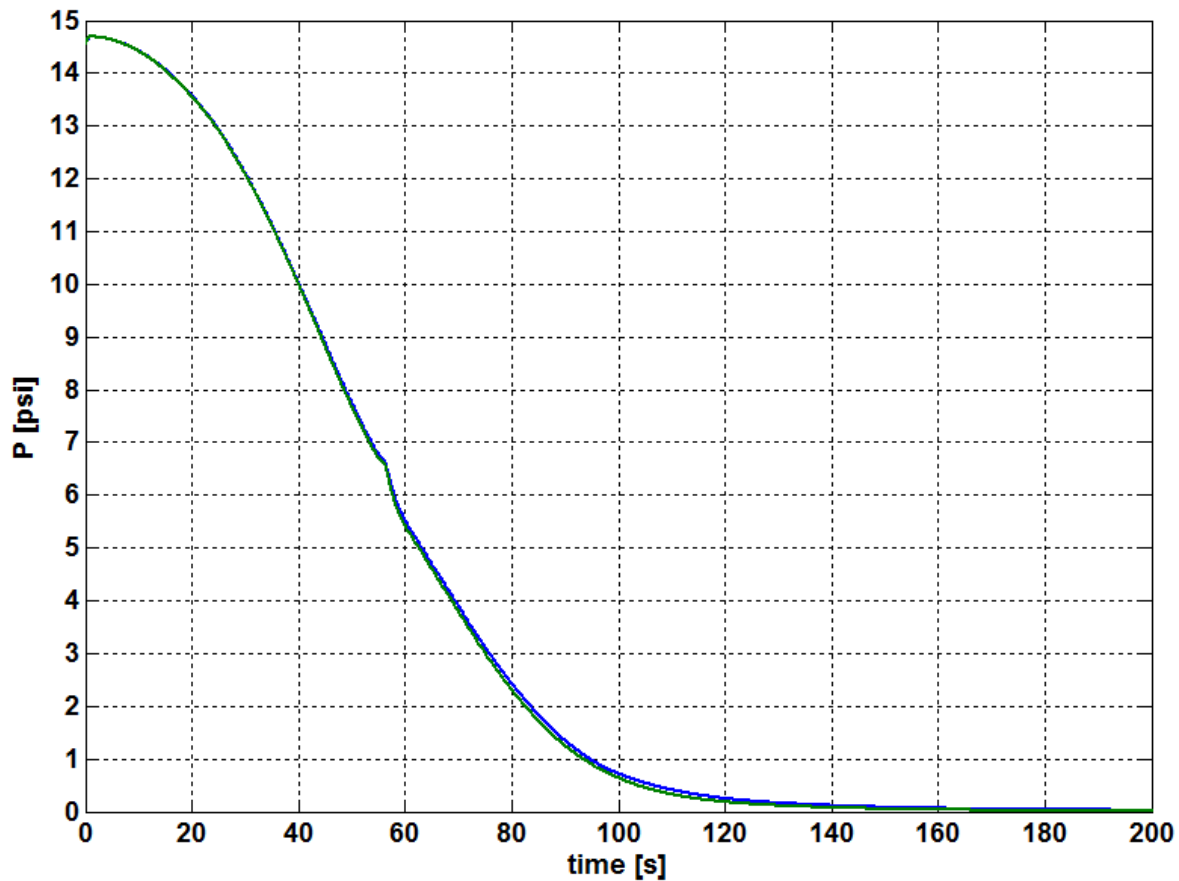

Figure 4-9: Falcon 9 fairing internal pressure and decay rate (representative)

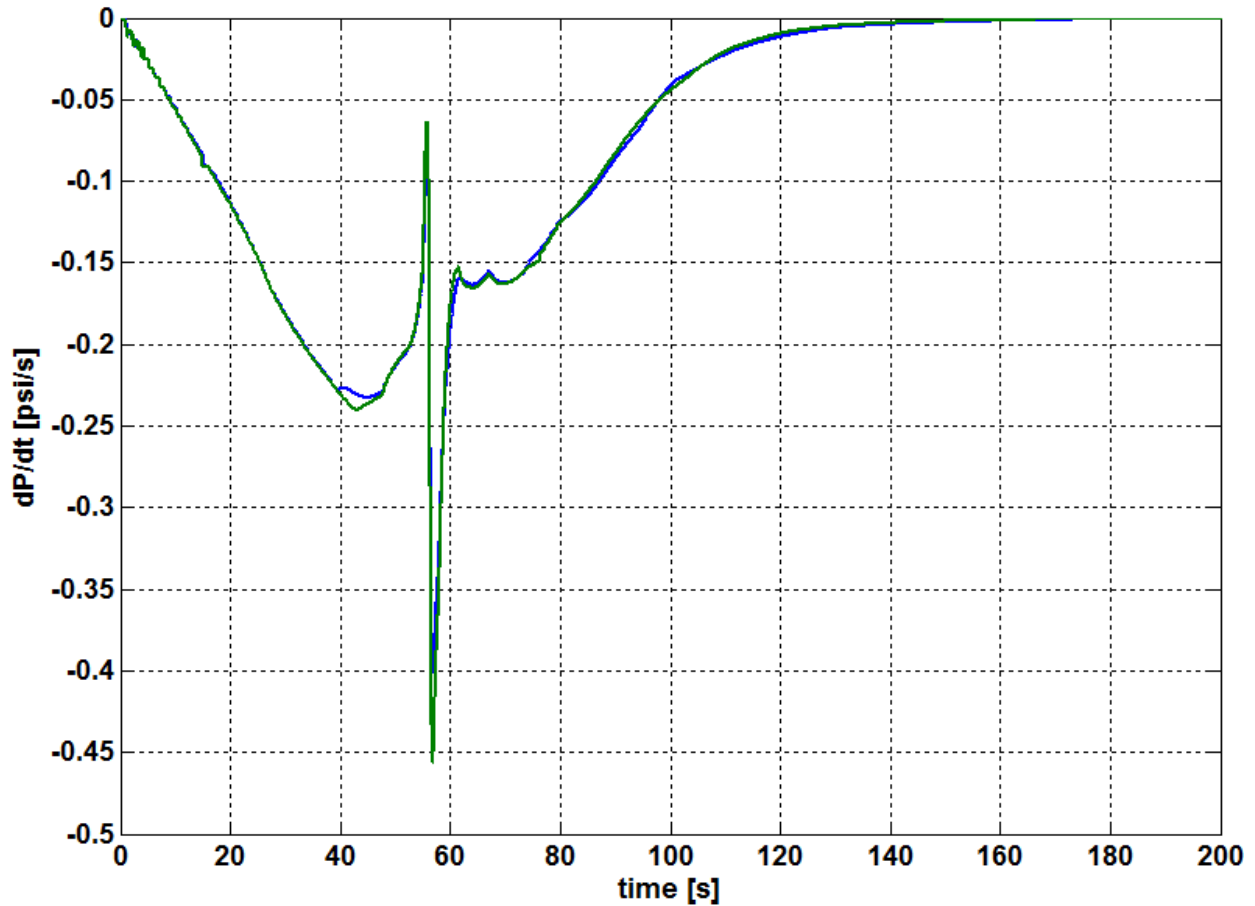

Figure 4-10: Falcon 9 fairing internal pressure change, transonic spike (representative)

#### 4.3.7 Payload Temperature Exposure during Flight

The SpaceX payload fairing is a composite structure consisting of a 2.5 cm (1 in.) thick aluminum honeycomb core surrounded by carbon fiber face sheet plies. The emissivity of the payload fairing is approximately 0.9. The fairing thermal insulation, which is attached to the outside of the fairing composite, is sized such that the composite never exceeds the ‘Boundary Design Temperature’ profile shown in Figure 4-11. The curve is truncated at 240 seconds, although the approximate time of payload fairing jettison for a geosynchronous transfer orbit mission from Cape Canaveral is typically earlier, at around 210 seconds into flight. Payload fairing jettison timing is determined by customer requirements and physical limitations of the system. Figure 4-11 also shows the worst-case fairing spot temperature given maximum ground and flight conditions, and is not representative of the average fairing temperature under maximum conditions.

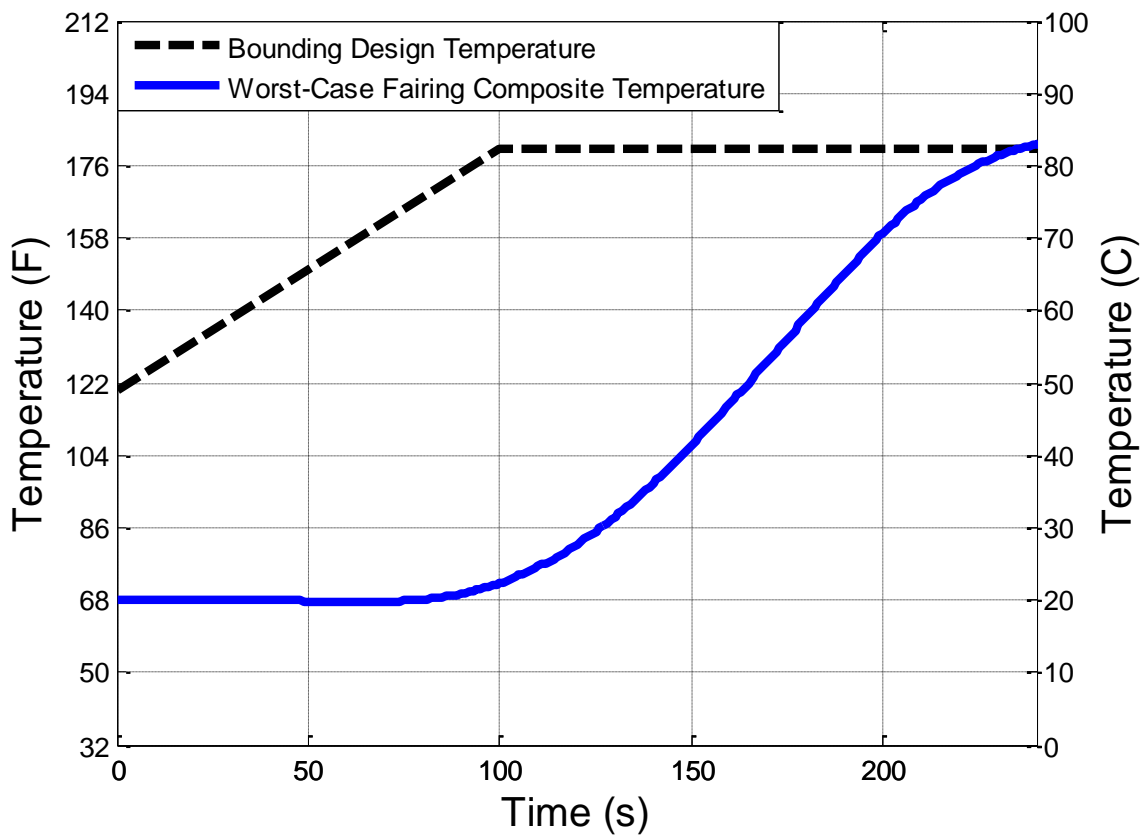

Figure 4-11: Maximum payload fairing spot temperature seen by payload

### 4.3.8 Free Molecular Heating

The payload fairing will nominally be deployed when free molecular aero-thermal heating is less than 1,135 W/m<sup>2</sup>. Other fairing deployment constraints can be accommodated as a standard service, although they may modestly reduce vehicle performance. Please contact SpaceX regarding mission-unique fairing deployment requirements.

### 4.4 Environmental Compatibility Verification

Prior to launch, SpaceX requires that customers verify the compatibility of their systems with the Falcon vehicles' maximum expected flight environments. SpaceX initiates this process by providing the applicable environments. The customer then summarizes its approach to environmental compatibility verification, and the process concludes with the customer providing test data to SpaceX, if necessary (Table 7-2).

Table 4-9 summarizes the typical verification activities performed by the customer and provides test levels based largely on Section 4.3 of this guide. Mission-unique limit levels and coupled loads analysis levels will be developed during the mission integration process and will serve as the basis for the verification activities. Alternate verification approaches may be acceptable, but coordination with SpaceX is required.



**Table 4-9: Spacecraft environmental compatibility verification example**

Environment	Verification Activities and Test Levels
Quasi-Static Loads (Section 4.3.1)	<p><b>Qualification:</b> Limit levels x 1.25</p> <p><b>Protoqualification:</b> Limit levels x 1.25</p> <p><b>Acceptance:</b> Limit levels x 1.0</p>
Sine Vibration (Section 4.3.2)	<p><b>Qualification:</b> Limit levels x 1.25, two octave/minute sweep rate</p> <p><b>Protoqualification:</b> Limit levels x 1.25, two octave/minute sweep rate</p> <p><b>Acceptance:</b> Limit levels x 1.0, four octave/minute sweep rate</p>
Acoustic (Section 4.3.3)	<p><b>Qualification:</b> Limit levels + 6 dB, 2 minutes duration</p> <p><b>Protoqualification:</b> Limit levels + 3 dB, 2 minutes duration</p> <p><b>Acceptance:</b> Limit levels, 1 minute duration</p> <p><i>Note: random vibration testing may be substituted for acoustic testing for spacecraft less than 182 kg (400 lb<sub>m</sub>) if customer analysis shows that the random vibration test is more severe than the acoustic test at all locations on the spacecraft</i></p>
Shock (Section 4.3.4)	<p><b>Qualification:</b> Limit levels + 3 dB at the launch vehicle-to-spacecraft interface, three shocks in all three axes; or three activations of all significant shock-producing events in a flight-like configuration</p> <p><b>Protoqualification:</b> Limit levels + 3 dB at the launch vehicle-to-spacecraft interface, two shocks in all three axes; or two activations of all significant shock-producing events in a flight-like configuration</p> <p><b>Acceptance:</b> Limit levels at the launch vehicle-to-spacecraft interface, one shock in all three axes; or one activation of all significant shock-producing events in a flight-like configuration</p> <p><i>Note: shock tests performed based on "Limit levels." Levels may be applied to all three axes simultaneously, or to each axis individually</i></p>
Radio Frequency (Section 4.3.5)	SpaceX standard service includes an electromagnetic compatibility assessment SpaceX recommends electromagnetic interference/compatibility testing be conducted for RF-sensitive payloads and may request insight into relevant testing performed
Pressure (Section 4.3.6)	SpaceX recommends venting analyses be conducted and may request insight into relevant analyses performed
Thermal (Section 4.3.7)	SpaceX recommends thermal cycle and thermal vacuum testing be conducted and may request insight into relevant testing performed

## 5. INTERFACES

---

### 5.1 Mechanical Interfaces

#### 5.1.1 Payload Adapters and Separation Systems

The standard mechanical interface between SpaceX-provided Falcon launch vehicle hardware and customer-provided hardware is a 1575-mm (62.01 in.) diameter bolted interface, at the forward end of the launch vehicle payload attach fitting (Figure 5-1). This interface is designed to conform to the EELV 1575-mm (62.01 in.) diameter medium payload class mechanical interface defined in the EELV Standard Interface Specification Rev. A July 2012.

For customers with 937-mm or 1194-mm (36.89 in. or 47.01 in.) clampband interface requirements, SpaceX will either provide and integrate a payload adapter and clampband separation system or will integrate an adapter and separation system chosen and provided by the customer, as a standard service. For customers with alternative interface requirements, SpaceX can procure almost any industry-standard adapter system as a nonstandard service. SpaceX has experience integrating numerous commercially available and internally developed adapters and separation systems. Falcon 9 is compatible with adapter and separation system products offered by RUAG, CASA, Planetary Systems Corporation and other industry-leading providers.

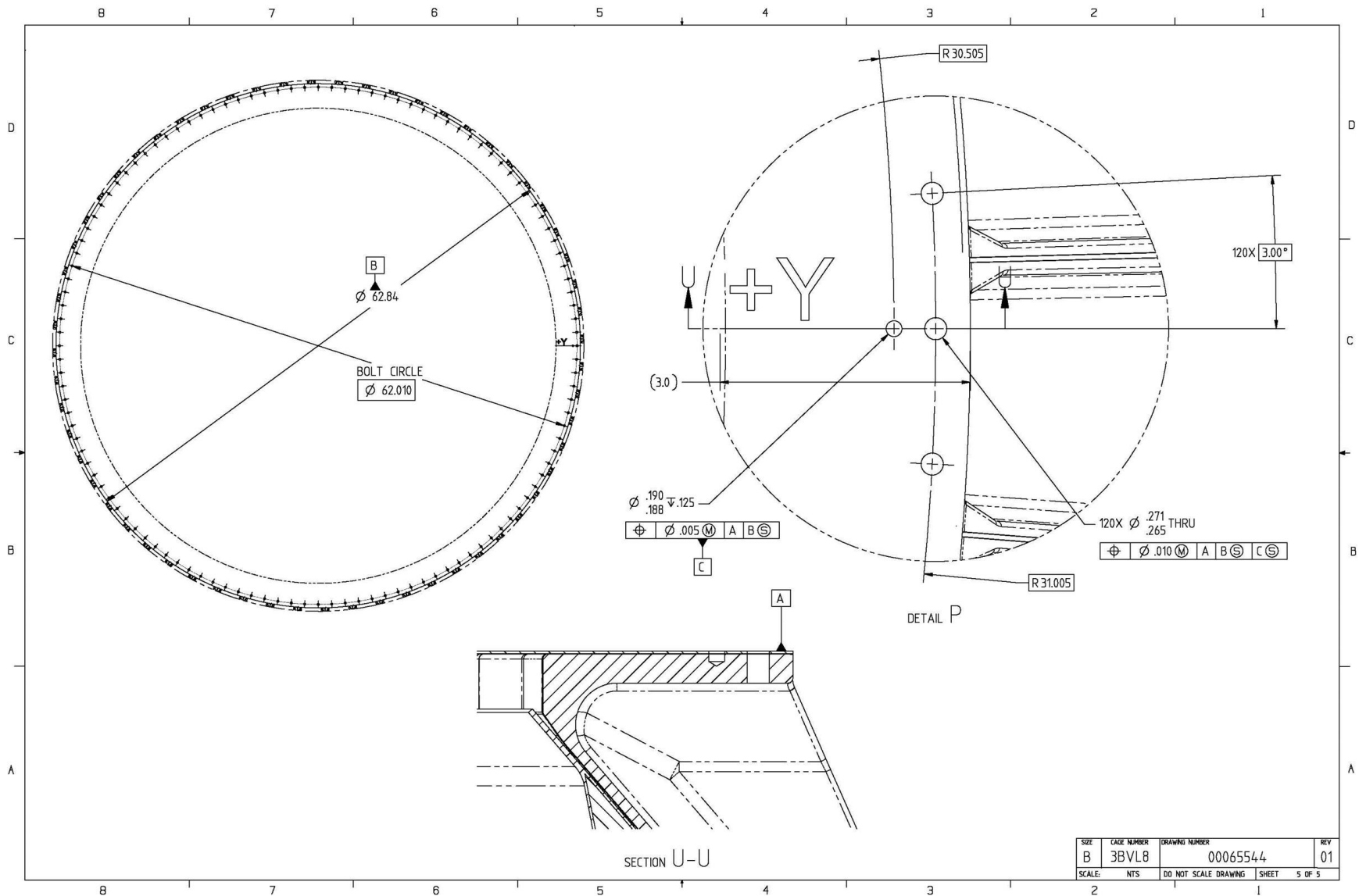

Figure 5-1: Falcon 9 payload interface ring (units are in inches)

### 5.1.2 Payload Fairing

The SpaceX fairing is 5.2 m (17.2 ft) in outer diameter and 13.2 m (43.5 ft) high overall. Fairing structures and dynamics result in a payload dynamic envelope with a maximum diameter of 4.6 m (15.1 ft) and a maximum height of 11 m (36.1 ft). The base of the payload dynamic envelope is defined by the standard 1575-mm interface plane at the forward end of the standard Falcon 9 payload attach fitting (Section 5.1.1); any payload adapters required (e.g., to achieve a 937-mm or 1194-mm (36.89 in. or 47.01 in.) interface) will utilize a portion of the payload dynamic envelope. The bolded dimensions in Figure 5-2 denote the standard payload dynamic interface. The non-bolded dimensions denote potential additional volume as a nonstandard service.

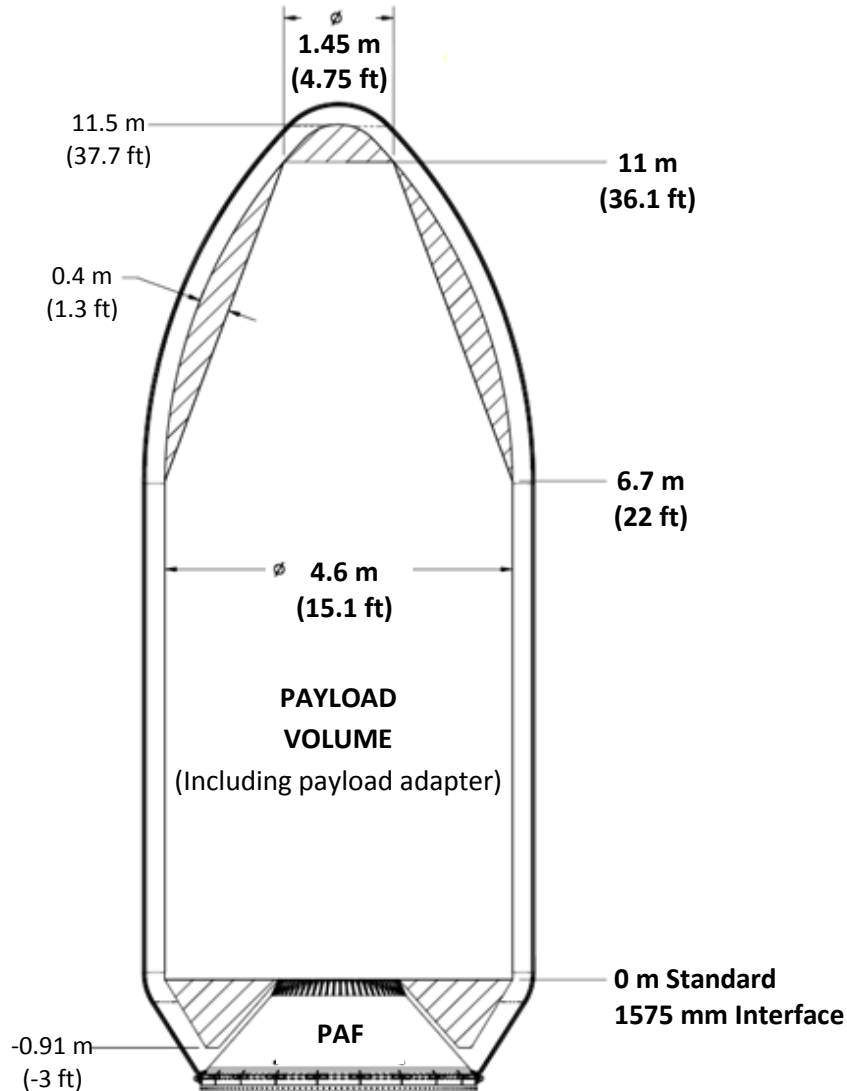

Figure 5-2: Falcon 9 fairing and payload dynamic envelope<sup>3</sup>, meters (feet)

<sup>3</sup> Payload dynamic envelope (shown as “payload volume”) indicates the volume that the spacecraft is allowed to move within, without intrusion by the fairing due to its dynamic motions.

The fairing can accommodate up to two access doors in the cylindrical portion as a standard service. The standard payload fairing door is elliptical, with a maximum size of 450 x 550 mm (17.7 x 21.7 in.).

Through-fairing RF antenna (re-radiation) systems are available as a nonstandard service; they are intended for use during payload antenna testing while on the launch pad, not for use during flight.

Other than remove/install-before-flight items, all processing requiring access to the payload must be completed prior to fairing installation. In the event of a payload anomaly requiring customer access to the payload, the standard concept of operations for Falcon vehicles is to return the launch vehicle to the hangar and remove the fairing. Access doors are not designed for emergency access into the payload fairing once the launch vehicle is on the pad.

Combinations of acoustic surfaces are used inside the payload fairing to help achieve the acoustic environments specified in Section 4.3.3.

## 5.2 Electrical Interfaces

Falcon vehicles provide electrical connectivity between the payload and customer-provided electrical ground support equipment (EGSE) prior to launch, as well as in-flight separation device commanding and separation monitoring. Falcon launch vehicles do not provide either payload command or interleaved telemetry access during flight as a standard service.

As a standard service, Falcon launch vehicles provide two in-flight disconnect electrical interface points located at the payload separation plane. Connector locations and pin designation will be determined during the mission integration process. SpaceX will supply 37- or 61-pin electrical connectors and will provide the payload-side connector halves to the customer. Alternatively, the customer can supply mission-unique electrical connectors and provide the launch vehicle-side connector halves to SpaceX.

### 5.2.1 Connectivity during Payload Processing and on Launch Pad

The Falcon 9 system accommodates electrical connectivity between customer EGSE and the payload during most processing and integration activities. Table 5-1 summarizes the availability of interfaces during standard processing and integration activities. Customers may connect directly between their EGSE and their payload during payload processing operations. Electrical interfaces will not be available during SpaceX adapter mate, encapsulation, launch vehicle integration and rollout operations. However, between these steps the customer will be able to interface with its payload. Customers may supply separate EGSE for payload processing facility (PPF) and pad operations or may relocate EGSE from the PPF to the pad.

**Table 5-1: Payload electrical interface connectivity**

Phase	Interface Connection
In PPF (payload processing)	Customer cables directly to payload
In PPF (adapter mate and encapsulation)	None – SpaceX is connecting the payload to the flight adapter harness, SpaceX will provided payload to PAF connection cables

In PPF (encapsulated)	Customer cables to PPF junction box
Transport to hangar	None – mobile
In hangar (pre-integration)	Customer cables to hangar junction box
In hangar (launch vehicle integration)	None – SpaceX is connecting the flight adapter harness to the second stage flight harness
In hangar (on transporter-erector)	Customer cables to hangar junction box
Rollout	None – mobile
On pad (horizontal and vertical)	6.1-m (20-ft) customer cables (provided by customer) to pad junction box
Flight	None – separation indication only

Pad EGSE provided by the customer will be housed in an instrument bay beneath the launch pad deck (Section 6.1). Payload EGSE is connected to a SpaceX-provided junction box. The payload customer typically provides 6.1-m (20-ft) cables to connect the payload EGSE to the junction box. SpaceX can provide this interface cable and can provide alternative connector interfaces as a nonstandard service.

The junction box is connected to the launch vehicle transporter-erector via a ground harness. A harness then runs along the length of the transporter-erector and connects to the second-stage T+0 quick-disconnect. The flight side of the second-stage quick-disconnect mates to two dedicated payload electrical harnesses that are provided by SpaceX as part of the second stage. The payload harnesses are routed along the exterior of the second-stage propellant tanks, underneath raceway covers that provide protection during ground and flight operations. At the top of the second-stage fuel tank the harnesses are routed across the payload attach fitting (Section 5.1.1) and to the spacecraft separation plane.

The total cable lengths between the payload racks/EGSE and the spacecraft separation plane are listed in Table 5-2 and shown in Figure 5-3.

**Table 5-2: Maximum expected cable lengths between payload racks/EGSE and the separation plane**

Launch Site	PPF	Hangar	Launch Pad
VAFB	25.9 m (85 ft)	204.5 m (671 ft)	167.9 m (551 ft)
CCAFS	18.3 m (60 ft)	200.8 m (659 ft)	175.6 m (576 ft)

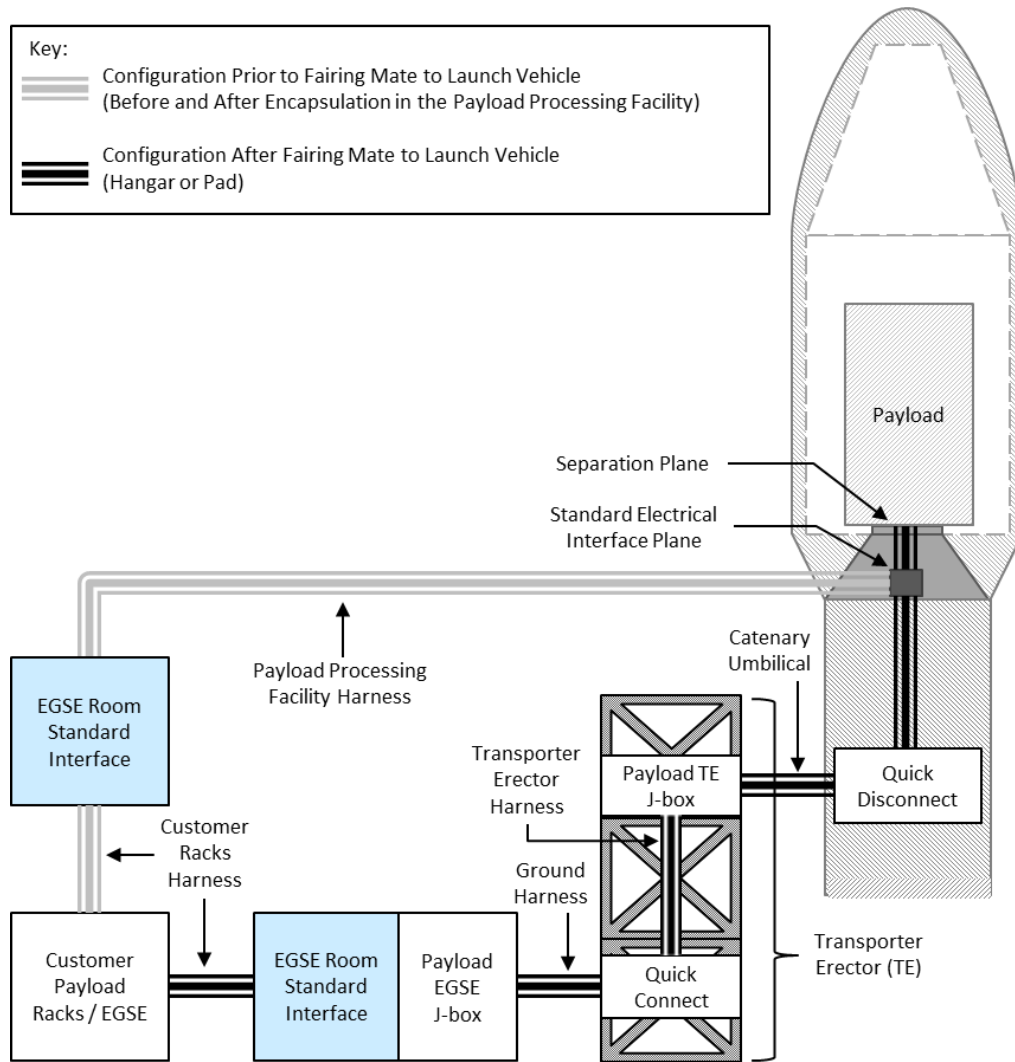

Figure 5-3: On-pad electrical interfaces

### 5.2.2 Falcon-to-Payload Command Interface

Falcon launch vehicles can provide up to 24 separation device commands, typically implemented as up to 12 redundant commands, as a standard service. More commands can be accommodated as a nonstandard service; please contact SpaceX for details. Separation device commands are used to initiate spacecraft separation from the second stage.

Falcon vehicles are capable of detecting up to 12 separation events through breakwire pairs, and a separation indication signal for each will be included in launch vehicle telemetry. SpaceX requires that at least one circuit on each spacecraft electrical connector be looped back on the spacecraft side for breakwire indication of spacecraft separation within launch vehicle telemetry. Customers may request that any number of circuits on the spacecraft electrical connectors be looped back on the launch vehicle side for breakwire indication of spacecraft separation within spacecraft telemetry.

### 5.2.3 Timing Services

SpaceX can supply inter-range instrumentation group IRIG-B000 or IRIG-B120 time from its GPS clocks to customer EGSE at the payload processing facility and/or the launch pad. A launch countdown clock can also be supplied in the IRIG CS-5246 format. These timing services are provided as a standard service; other options are available as nonstandard services.

## 5.3 Interface Compatibility Verification Requirements

SpaceX requires that customers verify the compatibility of their systems with the Falcon mechanical and electrical interfaces before shipment to the launch site. As a standard service, SpaceX will support a payload adapter mechanical fit check, including electrical connector location compatibility, at a facility of the customer's choosing. This interface compatibility verification does not include a shock test or any electrical tests. Second-unit and later flights of similar systems may be subject to reduced pre-ship verification requirements. Nonstandard verification approaches can be developed on a mission-unique basis.



## 6. FACILITIES

### 6.1 Cape Canaveral Air Force Station, Florida

SpaceX operates a Falcon launch site at Space Launch Complex 40 (SLC-40) at Cape Canaveral Air Force Station (CCAFS), Florida. SLC-40 was previously used by the US Air Force for Titan III and Titan IV launches, and it has been extensively modified by SpaceX to accommodate Falcon 9.

The SLC-40 launch pad is [located](#) at 28° 33.72' (28.5620°) N latitude, 80° 34.630' (80.5772°) W longitude. Launch azimuths from SLC-40 support low- to mid-inclination LEO, GTO and Earth escape orbits (Section 3.1).

SpaceX facilities at SLC-40 (Figure 6-1) include a launch vehicle integration hangar, propellant and pressurant storage and supply areas, a launch pad, and lightning towers. A SpaceX administrative facility is located adjacent to the launch complex.

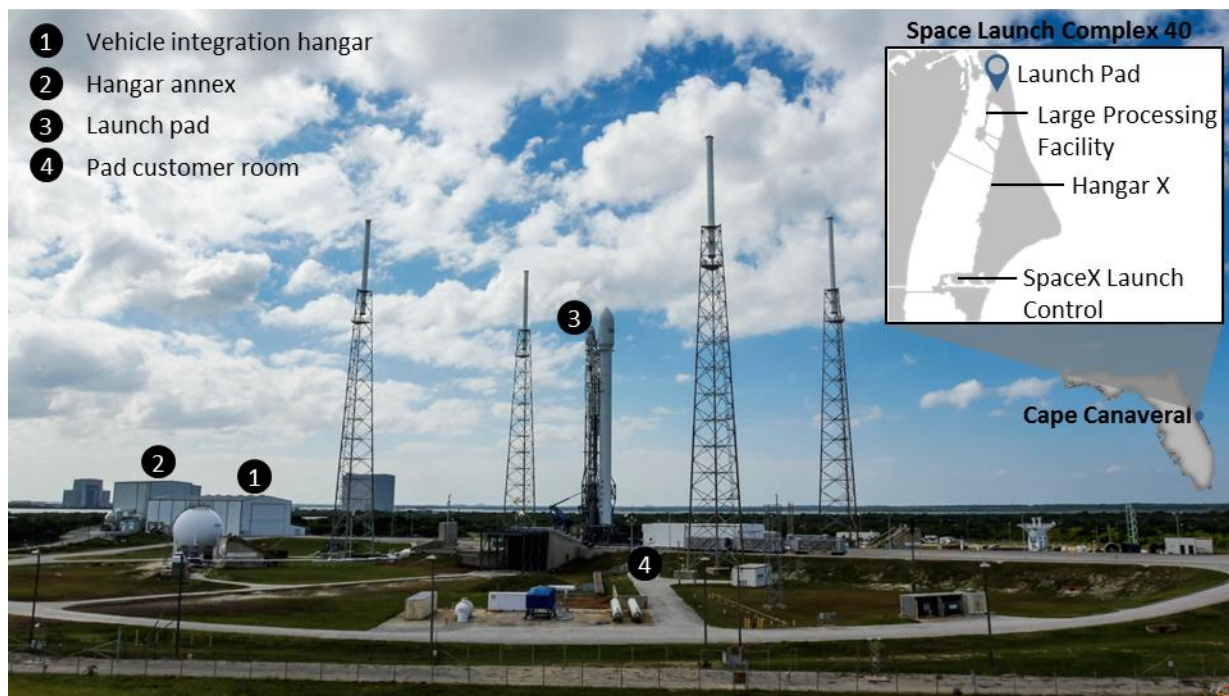

**Figure 6-1: Space Launch Complex 40 at Cape Canaveral Air Force Station, Florida**

SpaceX provides the use of an off-pad PPF as a standard service for CCAFS launch operations. CCAFS processing and launch operations, including PPF services, are described in Section 8.

#### 6.1.1 CCAFS Personnel Accommodations

##### 6.1.1.1 Access and Badges

CCAFS is a US Air Force Range with controlled access. SpaceX will facilitate pre-approval, badging and access for customer personnel requiring access to CCAFS. Once badged, customer personnel will have

access to the appropriate areas of the launch base. Non-US persons are subject to additional pre-approval and escort requirements, which will be facilitated by SpaceX.

**6.1.1.2 Transportation, Lodging and Services**

Customers typically fly commercial transport to Orlando International Airport, rent cars at the airport, and find lodging between Titusville and Cocoa Beach for the duration of their stay in Florida. Customer personnel who are US persons may use their own rental cars for on-base transportation. The area offers a full range of services; your mission manager can provide you with additional detailed recommendations. SpaceX does not provide transportation or lodging for customer personnel during CCAFS launch campaigns.

**6.1.1.3 Available Facilities for Customers**

As a standard service, SpaceX provides desk and office space for customer personnel at CCAFS in Hangar AO (Figure 6-2). These facilities are available from customer arrival through launch + 5 days. Offices are provided with US-standard power (120V, 60 Hz), high-speed Internet service and standard office equipment. The pad customer room is located in a bunker below the launch pad and is used during pad operations.

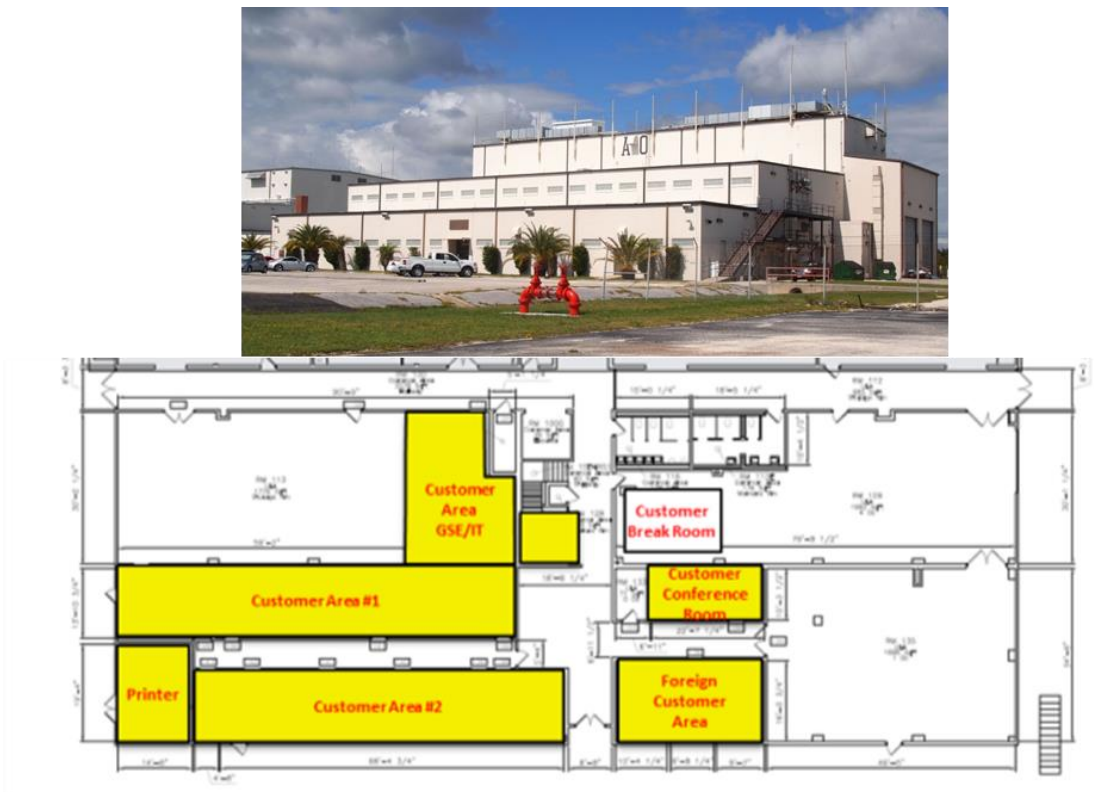

**Figure 6-2: Layout of customer office space in Hangar X**

The SpaceX Launch Control for SpaceX flights is located just outside the south entrance to CCAFS (Figure 6-3), providing easy access to all customers. These facilities are equipped with fiber-optic connections to the launch site and a connection into the launch site's main data system, allowing easy data

transfers between the control facility, the pad and the range, along with required external users and agencies. A customer room that can accommodate eight people is provided within the facility for customer technical management personnel.

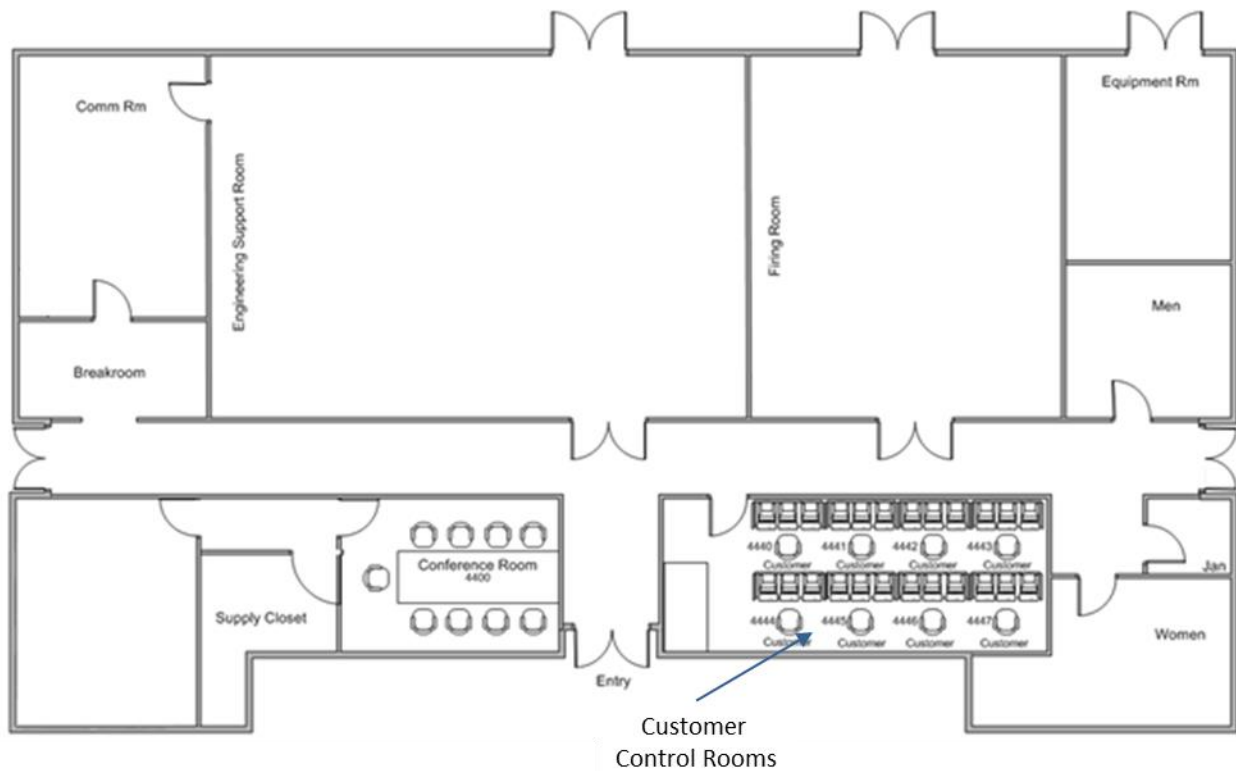

**Figure 6-3: SpaceX Launch Control facility layout**

## 6.2 Vandenberg Air Force Base, California

SpaceX operates a Falcon launch site at Space Launch Complex 4 East (SLC-4E) at Vandenberg Air Force Base (VAFB), California (Figure 6-4). SLC-4E was also previously used by the US Air Force for Titan III and Titan IV launches, and it has been extensively modified by SpaceX to accommodate Falcon 9 and Falcon Heavy. The facilities include the PPF, vehicle integration hangar, customer office area, pad customer room, launch pad, and launch and landing control. The PPF is attached to the north side of the vehicle integration hangar as shown in Figure 6-4. The two facilities share a common door through which an encapsulated payload will pass for integration to the launch vehicle. The customer office area is within walking distance of the PPF and is available to support customer administrative needs. There are multiple offices and conference rooms available in the building and sections of the building can be closed off as necessary to separate working areas between organizations. The pad customer room is located next to the launch pad and equipped to support customer EGSE racks and work stations during payload processing at the pad. The Launch and Landing Control (Bldg 8505) is located on the North Base and is equipped to support customer electrical ground support equipment racks and workstations for activities the day of launch.

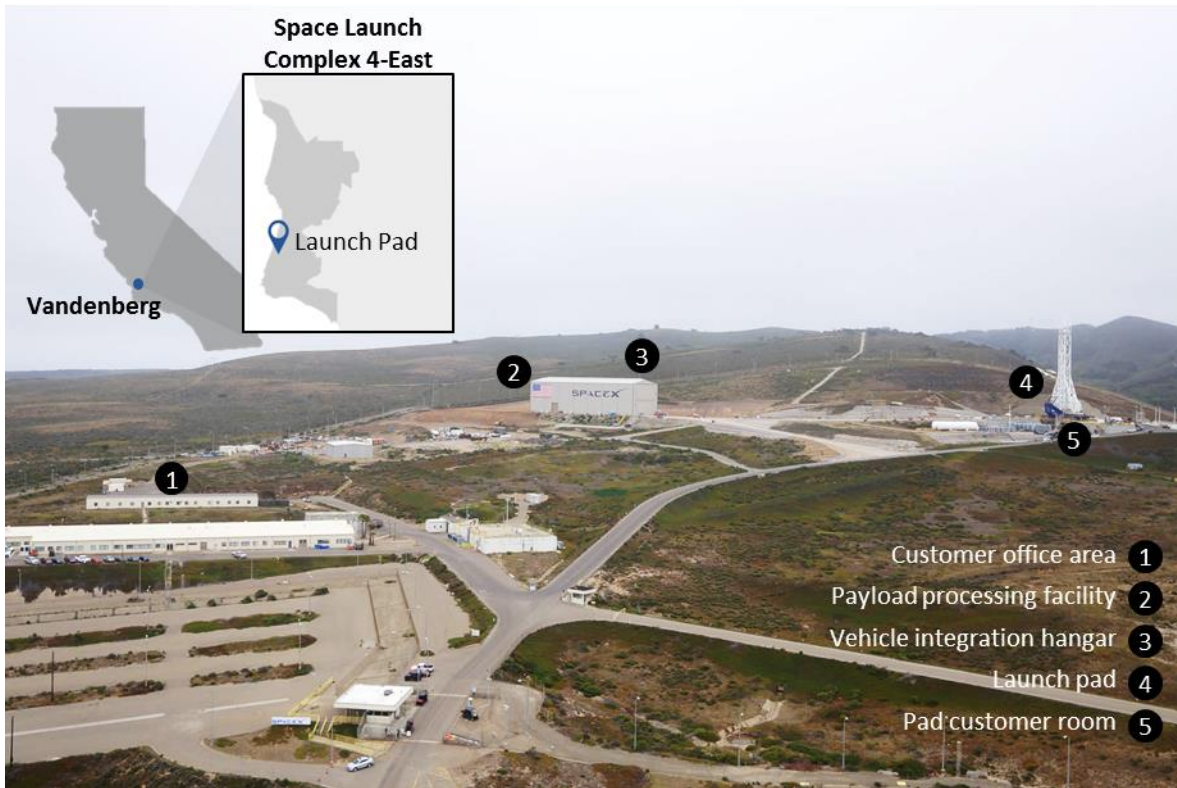

**Figure 6-4: Space Launch Complex 4 East at Vandenberg Air Force Base, California**

The SLC-4E launch pad is [located](#) at 34° 37.92' (34.6320°) N latitude, 120° 36.64' (120.6107°) W longitude. Launch azimuths from SLC-4E support high-inclination LEO orbits, including polar and sun-synchronous orbits (Section 3.1). SLC-4E processing and launch operations are described in Section 8.

## 6.2.1 VAFB Personnel Accommodations

### 6.2.1.1 Access and Badges

VAFB is a US Air Force base with controlled access. SpaceX will facilitate pre-approval, badging and access for customer personnel requiring access to VAFB. Once badged, customer personnel will have access to the appropriate areas of the launch base. Non-US persons are subject to additional pre-approval and escort requirements, which will be facilitated by SpaceX.

### 6.2.1.2 Transportation, Lodging and Services

Customers typically fly commercial transport to Los Angeles International Airport (LAX), rent cars at the airport, and find lodging between Lompoc and Santa Maria for the duration of their stay in California. The drive between LAX and VAFB takes approximately 3 hours. Customers occasionally fly into Santa Barbara Airport (SBA) as well; the drive from SBA to VAFB takes about an hour. Customer personnel who are US persons may use their own rental cars for on-base transportation. SpaceX does not provide transportation or lodging for customer personnel during VAFB launch campaigns. The area offers a full range of services; your mission manager can provide you with additional detailed recommendations.

6.2.1.3 Available Facilities for Customers

As a standard service, SpaceX provides desk and office space (Figure 6-5) for customer personnel. These facilities are available from customer arrival through launch + 5 days. Offices are provided with US-standard power (120 V, 60 Hz), high-speed Internet service and standard office equipment.

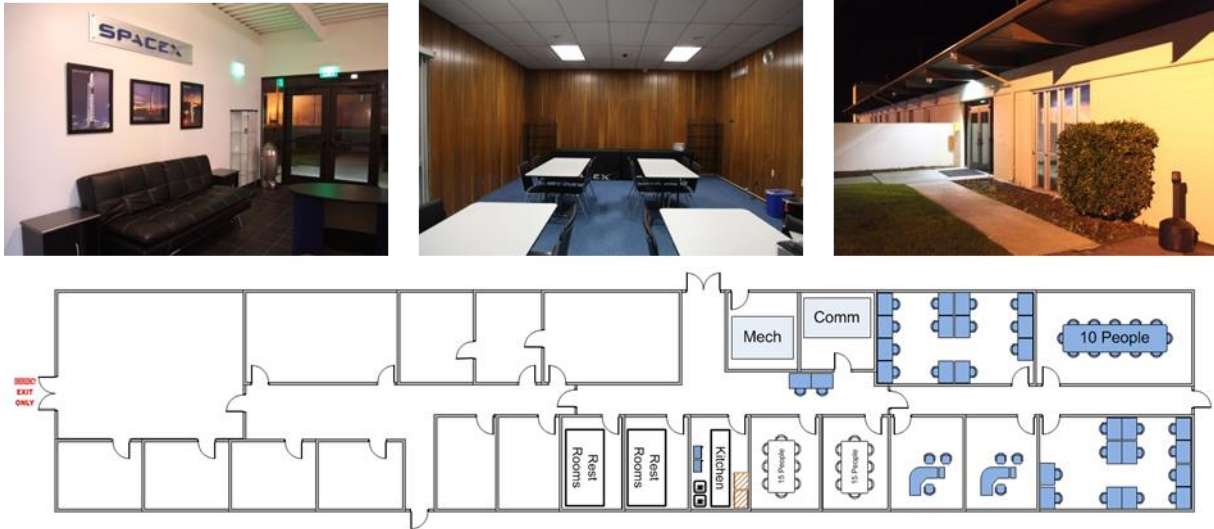

Figure 6-5: Vandenberg customer office space interior (left, center), exterior (right), and layout (bottom)

The pad customer room is located in a bunker below the launch pad and is used during pad operations. Figure 6-6 below shows the size and layout of this facility.

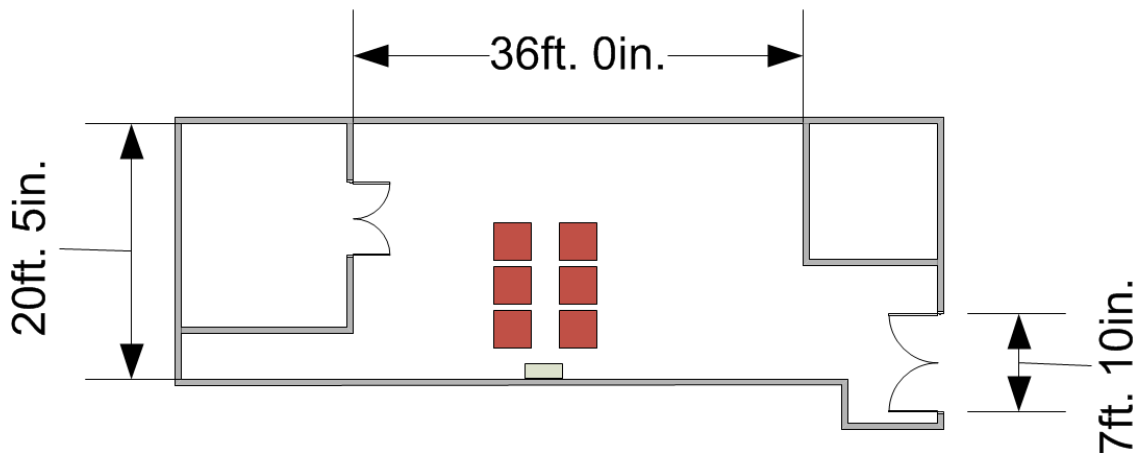

Figure 6-6: Pad customer room

The SpaceX Launch Control is located approximately 11 miles north of the pad. These facilities are equipped with fiber-optic connections to the launch site and a connection into the launch site's main data system, allowing easy data transfers between the control facility, the pad and the range, along with required external users and agencies. A customer room is provided within the facility and can accommodate up to 12 customer technical personnel.

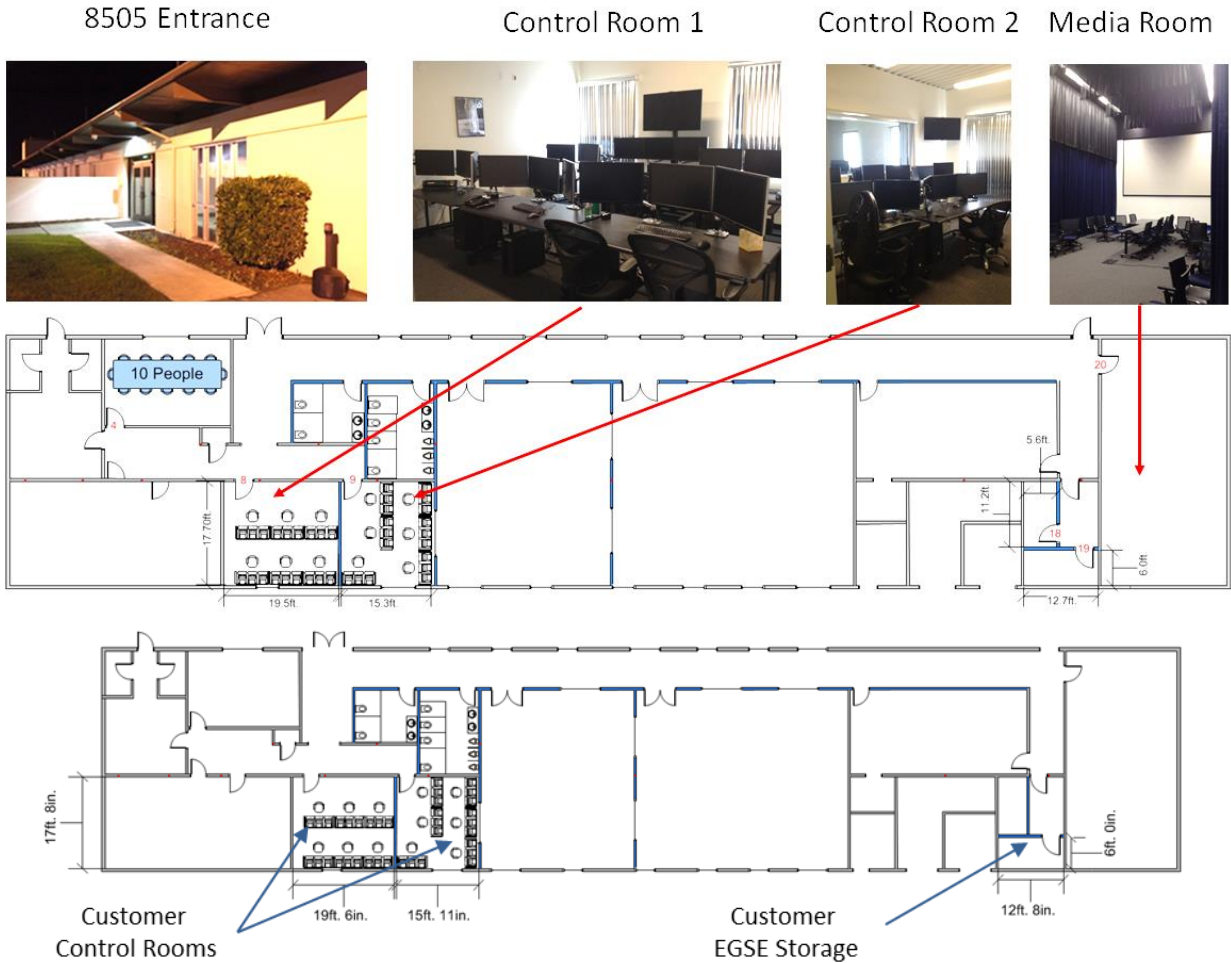

Figure 6-7: Customer control rooms at SpaceX Launch Control

### 6.3 Headquarters—Hawthorne, CA

SpaceX headquarters are conveniently located in [Hawthorne, CA](#), a few miles inland from Los Angeles International Airport (Figure 6-8). The design and manufacturing facility spans more than 1.5 million square feet and ranks among the largest manufacturing facilities in California; two complete Falcon 9s can fit end-to-end along the short length of the building. Facilities include multiple Falcon 9 manufacturing stations, nine stations for final assembly of the Merlin engine, and Dragon spacecraft production areas.



Figure 6-8: Hawthorne, California, headquarters

#### 6.4 Rocket Development Facility—McGregor, TX

Structural and propulsion testing are performed at the SpaceX Rocket Development Facility in McGregor, Texas (Figure 6-9). Conveniently located two hours from both Austin and Dallas, the site is staffed with test engineers, technicians and management personnel.

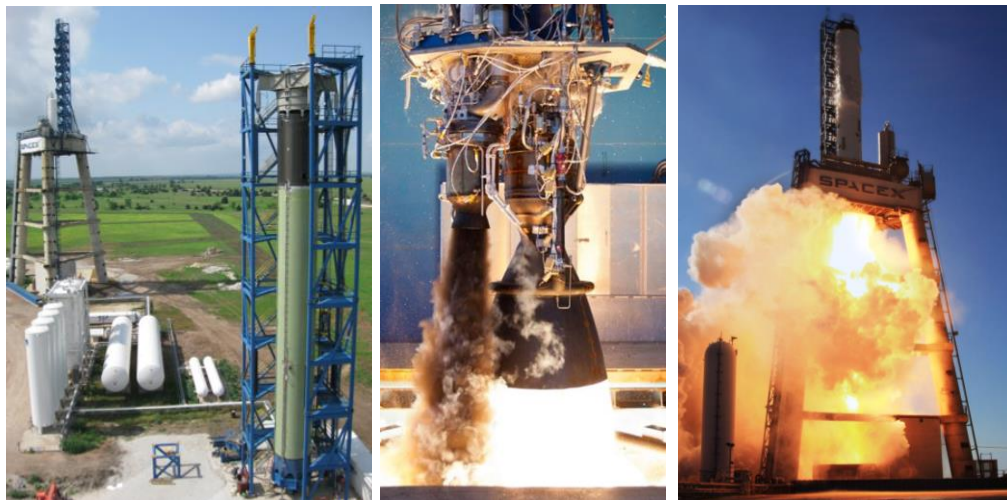

Figure 6-9: SpaceX Texas test facility and test operations

#### 6.5 Government Outreach and Legal Affairs—Washington, DC

SpaceX's government outreach and licensing team is located in Washington, DC.

## 7. MISSION INTEGRATION AND SERVICES

### 7.1 Contracting

Falcon 9 launch services are available via direct contract with SpaceX and through certain managed procurement services. To begin your direct contract relationship with SpaceX, please [contact](#) the SpaceX Sales department. The Sales department will work with you to develop a launch services contract.

### 7.2 Mission Management

To streamline communication and ensure customer satisfaction, SpaceX provides each Falcon launch services customer with a single technical point of contact from contract award through launch (Figure 7-1). Your mission manager will be responsible for coordinating mission integration analysis and documentation deliverables, planning integration meetings and reports, conducting mission-unique design reviews (as required) and coordinating all integration and test activities associated with the mission. The mission manager also coordinates all aspects of launch vehicle production, range and range safety integration, and all mission-required licensing leading up to the launch campaign. The mission manager works closely with the customer, SpaceX technical execution staff and all associated licensing agencies in order to achieve a successful mission.

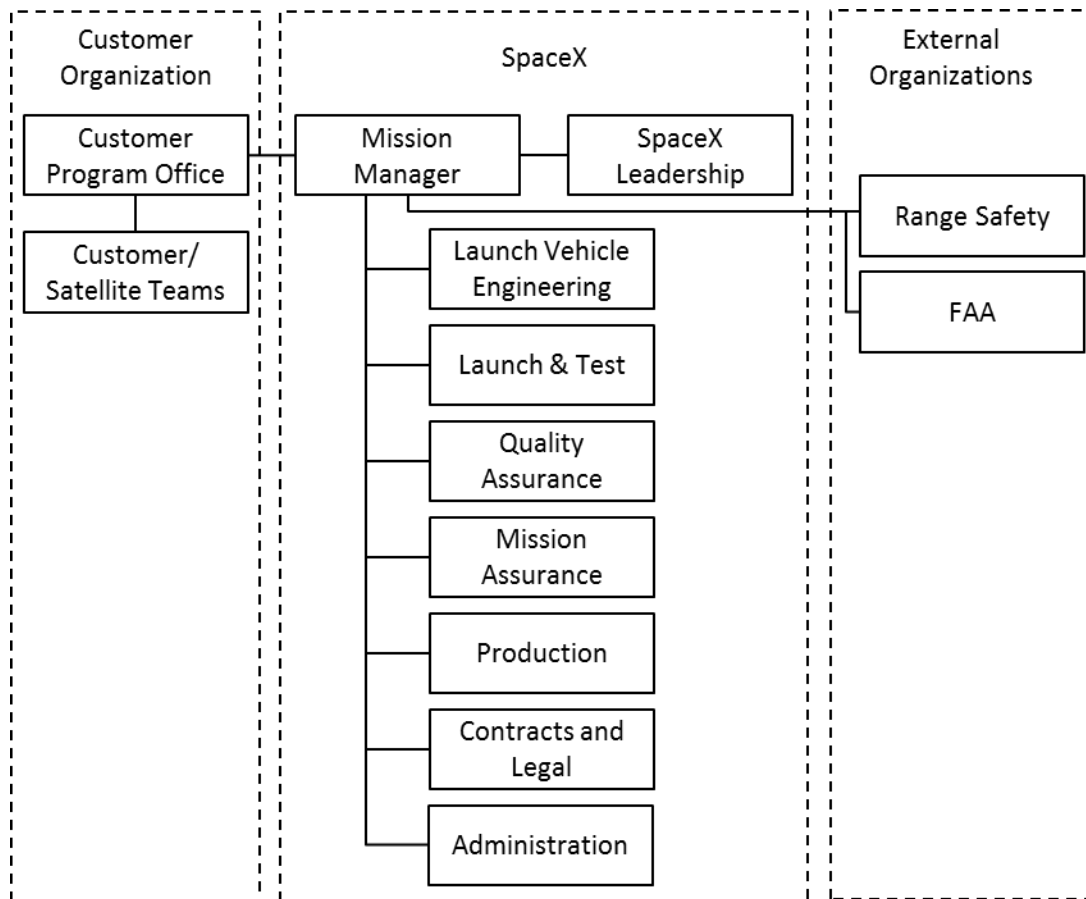

Figure 7-1: Mission management organization



The mission manager will work with the customer to create a spacecraft-to-launch vehicle interface control document (ICD)—the master document for a Falcon 9 mission. Following signature approval of the ICD, SpaceX maintains configuration control of the document.

Once the payload arrives at the launch site, physical accommodation of customer hardware and associated ground support equipment is managed by the payload integration manager—part of the launch operations team. However, the mission manager continues to be the customer's primary SpaceX point of contact at the launch site and coordinates all launch site activities to ensure customer satisfaction during this critical phase.

### 7.3 Standard Services

As part of any Falcon 9 launch service, SpaceX will:

- Provide personnel, services, hardware, equipment, documentation, analyses and facilities to support mission planning, launch vehicle production and acceptance, payload integration, and launch.
- Secure required launch licensing, including Federal Aviation Administration (FAA) and State Department licenses, with input from the payload customer. ( Note: Customers are responsible for any launch licenses specific to payload operation).
- Secure third-party liability insurance for the launch (Note: Customer retains responsibility for satellite insurance at all times).
- Provide all range and safety documents for the payload provider to complete (per AFSPCMAN 91-710 and 14 CFR Part 400).
- Facilitate the range and range safety integration process.
- Provide up to three sets of 37- or 61-pin satellite-to-launch vehicle in-flight disconnect electrical connectors, or integrate customer-provided mission-unique connectors.
- Provide a 1575-mm bolted interface compatible with the 62.01-in. diameter Medium Payload Class mechanical interface defined in the EELV Standard Interface Specification.
- Provide one 937-mm or 1194-mm (36.89-in. or 47.01-in.) adapter and low-shock clampband separation system, or integrate a customer-provided mission-unique separation system.
- Provide an adapter and technical support for a mechanical interface compatibility verification test at a facility of the customer's choosing.
- Provide transportation for the customer's spacecraft container and all ground support equipment (GSE) from the launch site landing location to the spacecraft processing location, if necessary.
- Provide ISO Class 8 (Class 100,000 cleanroom) integration space for the payload and GSE prior to the scheduled launch date, including facilities and support to customer's hazardous operations.
- Provide certified mechanical GSE to support physical mating of the payload to the payload adapter, perform fairing encapsulation, and integrate the encapsulated system with the launch vehicle.
- Process the launch vehicle, integrate and encapsulate the payload within the fairing, and test electrical interfaces with the payload.
- Provide conditioned air into the fairing during encapsulated ground processing.
- Provide two payload access doors in the fairing at pre-designed locations.
- Produce a customer logo and install it on the launch vehicle.

- Conduct a countdown dress rehearsal for customer launch team members supported by SpaceX Mission Management.
- Launch the payload into the specified orbit within the specified environmental constraints.
- Perform 3-axis attitude control or spin-stabilized spacecraft separation.
- Perform a collision avoidance maneuver (as required).
- Verify spacecraft separation from the launch vehicle and provide an orbit injection report.
- Deliver a final post-flight report, which will include payload separation confirmation, ephemeris, payload environment, significant events and any mission-impacting anomalies.

A detailed statement of work and deliverables list, including these standard services, will be developed during contract negotiation.

#### 7.4 Schedule

Table 7-1 provides a standard launch integration schedule, starting at contract signature and proceeding through the post-flight summary. A detailed schedule, including required customer deliverables, is developed during contract negotiation.

**Table 7-1: Standard launch integration schedule**

Estimated Schedule	Title	Purpose
L-24 months	Contract signature	Provides authority to proceed with work
L-22 months	Mission integration kickoff	Presents the project schedule, a summary of mission requirements and proposed preliminary design solutions for any mission-unique requirements
L-12 months	Completion of mission-unique design and analyses	All mission-unique design and analysis results are delivered to the Customer and the ICD is prepared for signature in advance of this milestone
L-3 months	Launch campaign kickoff	Verifies that all people, parts and paper are ready for the shipment of the payload to the launch site and are ready to begin launch site activities
L-1 week	Rollout readiness assessment	Readiness assessment after payload integration to the launch vehicle and prior to launch vehicle rollout to the launch pad. Intended to verify that all systems (ground facilities, launch vehicle and payload) are ready for launch

L-2 days	Launch readiness review	Conducted two days prior to launch to verify readiness to proceed with the countdown and launch, including launch range and FAA concurrence
Separation + TBD minutes	Orbit injection report	Deliver best-estimate state vector, attitude, and attitude rate based on initial data
Launch + 8 weeks	Flight report	Report of the flight, environments, separation state, and a description of all mission-impacting anomalies and progress on their resolution

### 7.5 Customer Deliverables

Table 7-2 and Table 7-3 provide an overview of standard documentation and information required from the customer. Note: these lists are not all-inclusive but, rather, represent minimum requirements. Depending on the specific payload, additional customer requirements may apply.

**Table 7-2: Required documents and data for all payloads**

Payload safety data	Provides detailed payload information to support SpaceX generation of range safety submittals, requirements tailoring and launch operations planning. Includes hazard analyses and reports, vehicle break-up models and detailed design/test information
Finite-element and CAD models	Used in coupled loads analyses and compatibility assessments. Specific format and other requirements are supplied during the mission integration process
Environment analysis inputs	Payload inputs for SpaceX environment analyses. Includes payload thermal model and others, as required
Inputs to ICD	The ICD describes all mission-specific requirements. SpaceX generates and controls the ICD, but input is required from the customer. ICD compliance information is required prior to launch
Environmental test statement and data	Defines the payload provider's approach to qualification and acceptance testing, including general test philosophy, testing to be performed, objectives, test configuration, methods and schedule. Actual test procedures are not required. Specific qualification and acceptance test data may be required prior to launch to demonstrate compatibility with the SpaceX launch service
Customer logo for launch vehicle (optional)	Proposed design should be submitted no later than five months before launch for review and approval. Following approval, SpaceX will have the logo prepared and placed on the launch vehicle
Launch site operations plans and procedures	Describes all aspects of mission activities to be performed at the launch site. Operating procedures must be submitted for all operations that are accomplished at the launch site. Hazardous procedures must be approved by Range Safety
Mission data	Information in support of reviews is required throughout the mission integration

	process
--	---------

**Table 7-3: Additional required documents and data for non-US persons and non-US government payloads**

FAA payload determination information	Non-US government payloads must be reviewed by the Federal Aviation Administration to determine whether their launch would jeopardize public safety and other US interests (Title 14 CFR part 415 subpart D). Payload providers may need to provide additional information to enable SpaceX to submit an application for review
Launch site visitor information	To obtain the appropriate permissions, SpaceX requires information for non-US customer personnel prior to visiting the launch site
Launch site GSE details	Details on ground support equipment (GSE) that a non-US customer plans to bring to the launch site are required for import/export compliance

## 8. OPERATIONS

Falcon launch vehicle operations are described in this section for launches from CCAFS (Section 6.1) and VAFB (Section 6.1.2). SpaceX launch operations are designed for rapid response (targeting less than one hour from vehicle rollout from the hangar to launch). Customers are strongly encouraged to develop launch readiness capabilities and timelines consistent with a rapid prelaunch concept of operations.

### 8.1 Overview and Schedule

The Falcon launch vehicle system and associated operations have been designed for minimal complexity and minimal time at the pad (Figure 8-1). Customer payload processing is performed in a payload processing facility (PPF). After completion of standalone spacecraft operations (typically over a 20-day period) by L-10 days, SpaceX performs the adapter mate and fairing encapsulation at the PPF. The spacecraft is then transported to the integration hangar. The launch vehicle is processed in the integration hangar at the launch complex and then loaded on the transporter-erector. The encapsulated assembly is mated to the launch vehicle at approximately L-5 days, followed by end-to-end system checkouts. Falcon 9 systems are designed for rollout and launch on the same day, but SpaceX can perform an earlier rollout and conduct a longer countdown if required.

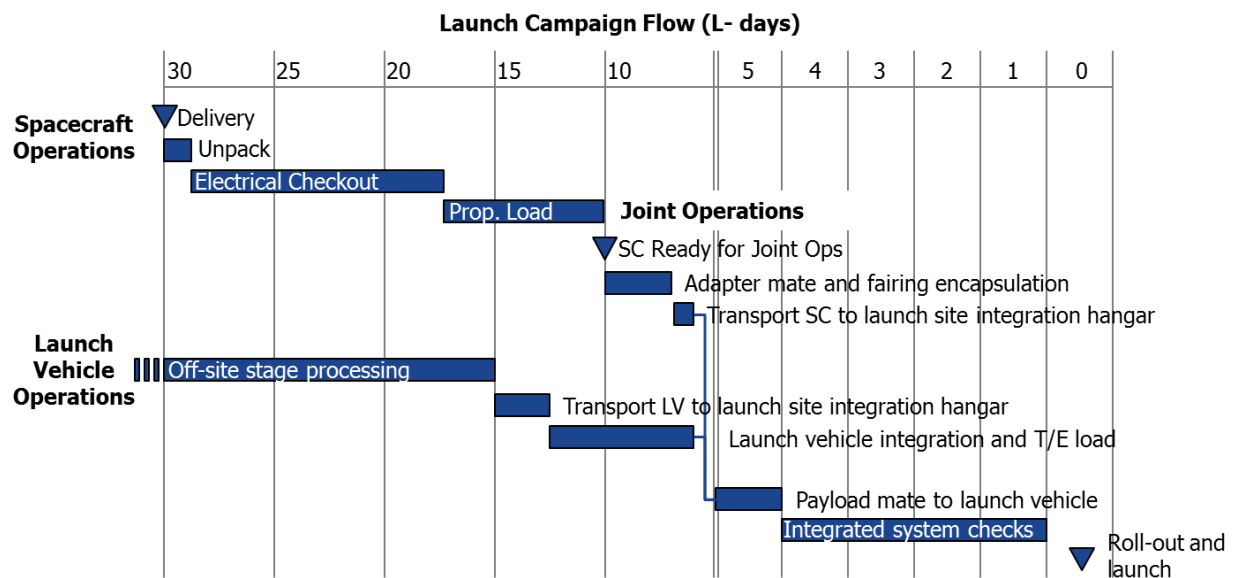

Figure 8-1: Illustrative Falcon 9 processing, integration and launch operations schedule

### 8.2 Spacecraft Delivery and Transportation

For standard service processing and integration, payloads should be delivered to the launch site four weeks prior to launch. Alternative delivery schedules can be arranged as a nonstandard service.

Customers typically deliver their payloads via air or ground transport. Cape Canaveral offers two convenient landing locations for customers delivering their payloads and associated equipment via air transport: the Shuttle Landing Facility and the CCAFS Skid Strip. Vandenberg provides one landing location at the VAFB airfield, approximately 14 miles north of the launch complex. Non-US payloads

coming to VAFB via the airfield must clear customs at LAX or another port of entry prior to arrival at VAFB.

As a standard service, SpaceX will arrange for the customer's spacecraft container and all associated test and support equipment to be offloaded from the plane and transported to the payload processing facility. Ground transport services can also be provided by AstroTech or Spaceport System International; SpaceX can facilitate these as a nonstandard service.

### 8.3 Spacecraft Processing

SpaceX provides an ISO Class 8 (Class 100,000) PPF for processing customer spacecraft, including equipment unloading, unpacking/packing, final assembly, nonhazardous flight preparations, and payload checkout. The payload processing facility is available to customers from four weeks prior to launch, with 16 hours per day standard availability and access during that period. Additional time in the payload processing facility may be available as a nonstandard service. The PPF layouts for VAFB and CCAFS are shown in Figure 8-2 and Figure 8-3, respectively.

Services and equipment provided for satellite processing within the PPF are outlined in Table 8-1. Additional space is provided for customer ground support equipment and operations personnel. A facility HVAC system maintains payload processing facility environments. SpaceX will continuously monitor relative humidity, temperature and cleanliness in the payload processing facility using particle counters. Cleanliness monitoring using witness plates is available as a nonstandard service. After encapsulation and prior to launch vehicle mate, SpaceX will verify purge media source and ducting cleanliness. The customer must supply any necessary cables and converters for its ground support equipment to interface with payload processing facility power. SpaceX can supply alternative power sources as a nonstandard service.

The PPF is also designed to accommodate hazardous operations such as hypergolic propellant loading and ordnance installation. Any required fueling operations will be performed by customer personnel with assistance from SpaceX personnel. All personnel must use certified SCAPE suits, pass a physical and attend SCAPE training classes.

All spacecraft processing operations within the PPF must be completed by L-10 days to allow for mating to the payload adapter, fairing encapsulation and transportation to the launch vehicle integration hangar in preparation for launch.

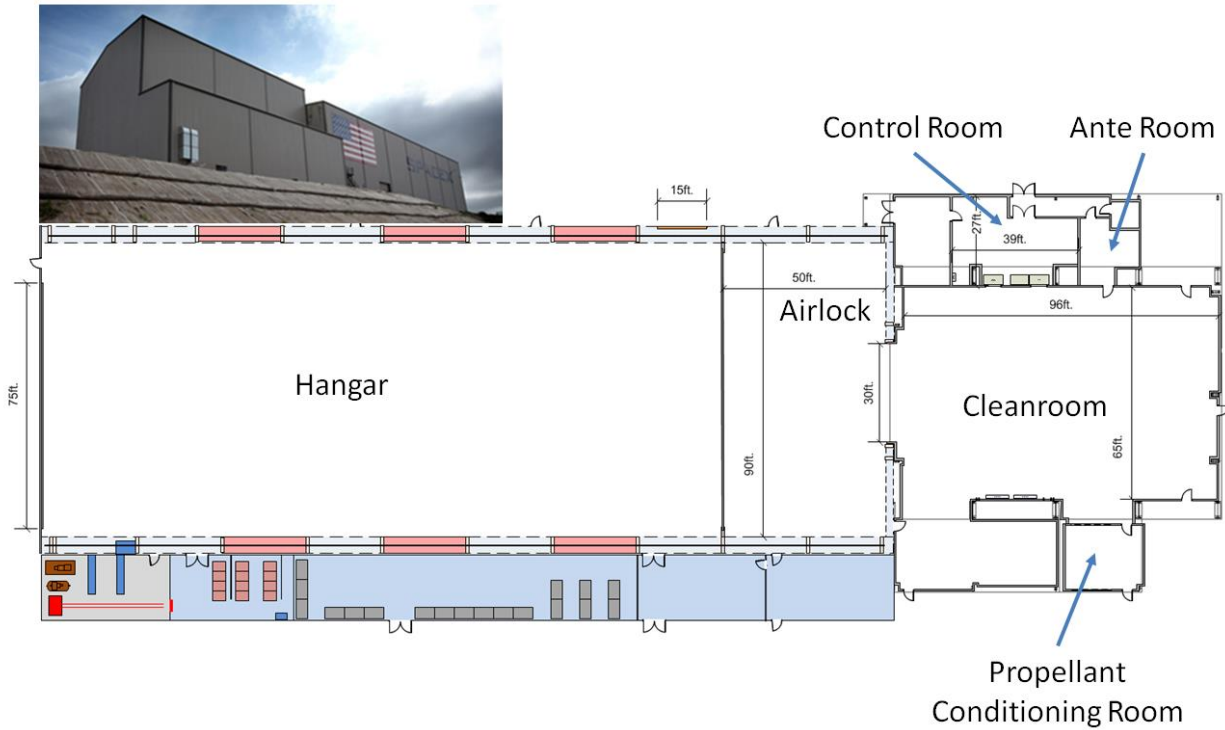

Figure 8-2: VAFB payload processing facility and integration hangar layout

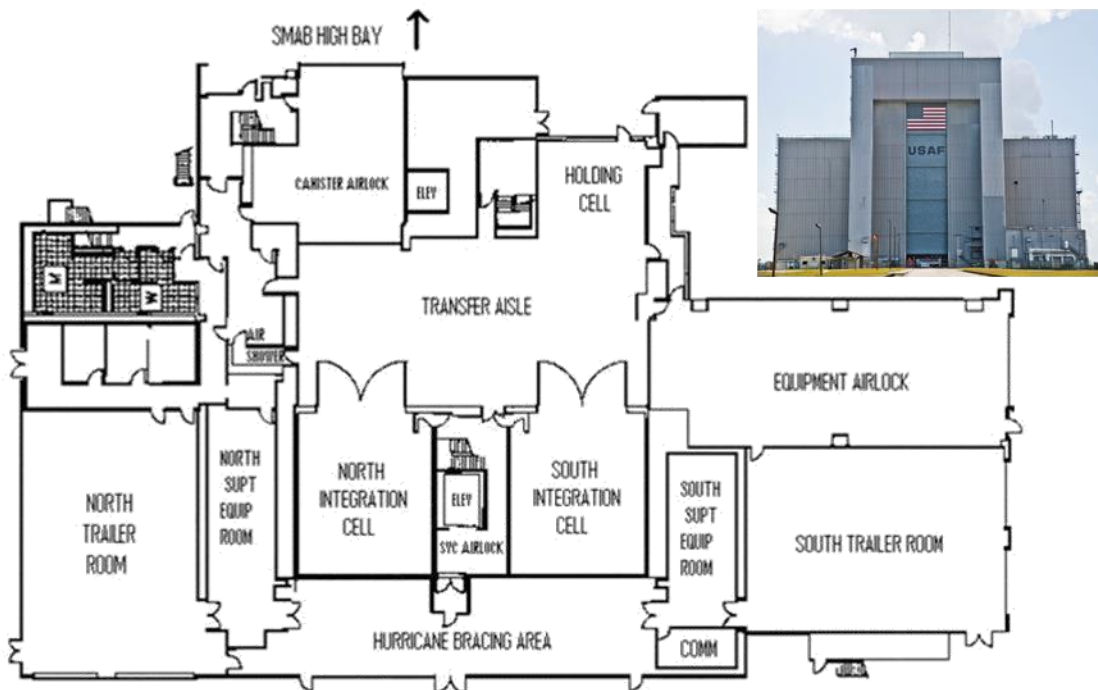

Figure 8-3: CCAFS payload processing facility layout

**Table 8-1: Services and equipment for payload processing**

	CCAFS	VAFB
<b>Clean room</b>		
Dimensions	No less than 29 m x 16.5 m floor size (95 ft x 54 ft)	No less than 29.2 m x 20.7 m floor size (95.8 ft x 67.9 ft)
Exterior door	No less than 7.62 m high x 15.24 m wide (25 ft x 50 ft)	No less than 6.01 m high x 6.01 m wide (20 ft x 20 ft)
Temp/Clean	See Table 4-2 (PPF facility HVAC)	See Table 4-2 (PPF facility HVAC)
<b>Overhead crane</b>		
Quantity	2	2
Hook height	18 m (59 ft)	18.3 m (60 ft)
Capacity	Crane 1: 27,215 kg (30 ton) Crane 2: 13,607 kg (15 ton) both certified for hypergolic lifting	North Crane: 27,215 kg (30 T) South Crane: 18,143 kg (20 T)
Hoist Speed (min/max)	6.1 cm/609 min (0.2 ft /20 min), per crane	6.1 cm/609 min (0.2 ft/20 min), per crane
Operation modes	Independent	Independent or synchronized
<b>Access equipment</b>		
	45-ft boom lifts, pallet jack, lifting hardware, ladders, movable platforms	Pallet jack, lifting hardware, ladders, movable platforms
<b>Electrical</b>		
60 Hz AC	120 V 1-phase, 120/208 V 3-phase, and 480 V 3-phase service	120 V 1-phase and 120/208 V 3-phase service
50 Hz AC	220/380V – WYE, 3-Phase, 5-Wire with UPS back up	220/380V- WYE, 3-Phase, 4-Wire with UPS backup
Grounding	Per MIL-STD-1542	Per MIL-STD-1542
<b>GN<sub>2</sub> supply</b>		
Quality	MIL-PRF-27401, Grade B	MIL-PRF-27401, Grade B
Pressure	34,473 kPa (5,000 psi)	34,473 kPa (5,000 psi)
Flow rate	1699.2 Nm <sup>3</sup> /hr (1,000 scfm)	1699.2 Nm <sup>3</sup> /hr (1,000 scfm)
<b>Helium supply</b>		
Quality	MIL-PRF-27407, Grade A	MIL-PRF-27407B, Type 1, Grade B
Pressure	39,300 kPa (5,700 psi)	41,368 kPa (6,000 psi)
Flow rate	1699.2 Nm <sup>3</sup> /hr (1,000 scfm)	1699.2 Nm <sup>3</sup> /hr(1,000 scfm)
<b>Compressed air supply</b>		
Pressure	758 kPa (110 psi)	862 kPa (125 psi)
<b>Communications</b>		



Administrative phone	VOIP phones	VOIP phones
Paging system	Yes	Yes
Area warning system	Yes	Yes
<b>Security</b>		
Locking facility	Yes	Yes
Launch site badges	Yes	Yes
Video monitoring	Yes	Yes

As an alternative nonstandard service, SpaceX can arrange the use of commercial processing facilities near CCAFS or VAFB for payload processing. If a payload is processed at a facility other than the SpaceX-provided payload processing facility, SpaceX can provide environmentally controlled transportation from that facility to the launch vehicle integration hangar.

### 8.4 Joint Operations and Integration

Joint operations begin ten days before launch. Payload attachment to the payload attach fitting and fairing encapsulation are performed by SpaceX within the payload processing facility (Figure 8-4). Fairing encapsulation is performed in the vertical orientation. Transportation is performed in the vertical orientation, and environmental control is provided throughout the transportation activity. Once at the launch vehicle integration hangar, the encapsulated assembly is rotated to horizontal and mated with the launch vehicle already positioned on its transporter-erector.

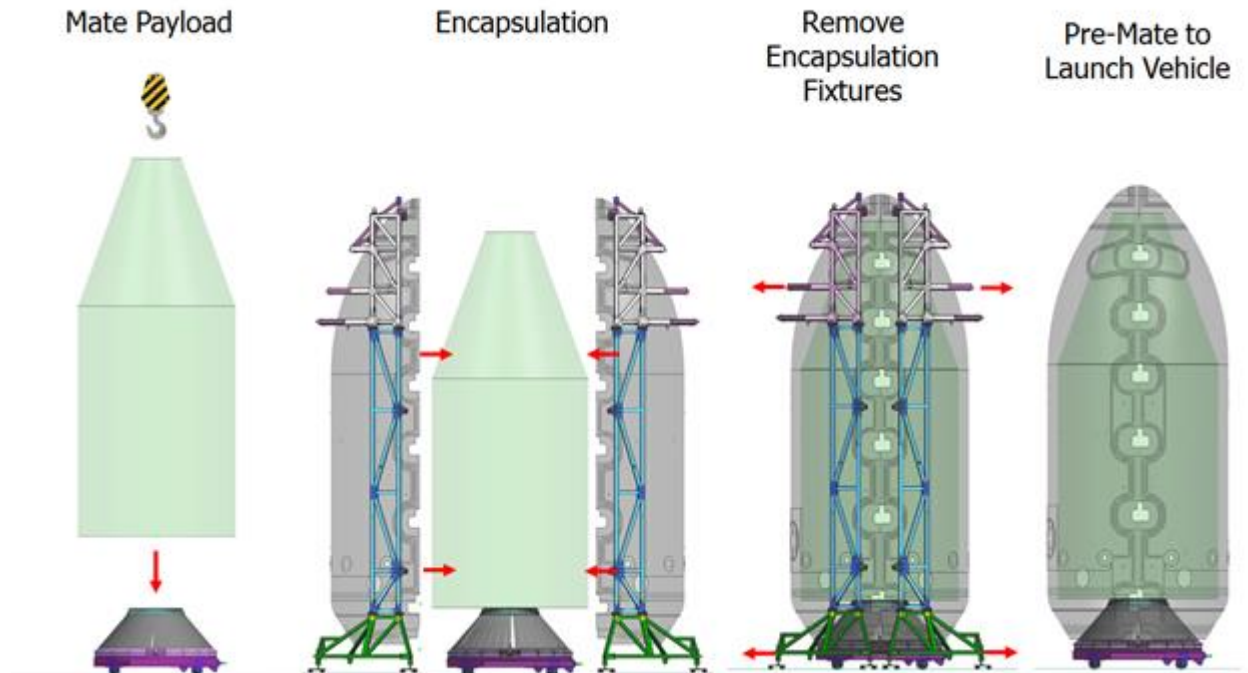

Figure 8-4: Payload encapsulation and integration sequence

Once the encapsulated assembly is mated to the launch vehicle, the hangar facility HVAC system is connected via a fairing air conditioning duct to maintain environmental control inside the fairing. The payload is then reconnected to electrical ground support equipment (if required) and electrical interfaces are verified. At this point, the integrated launch vehicle is ready for rollout and launch (Figure 8-5).

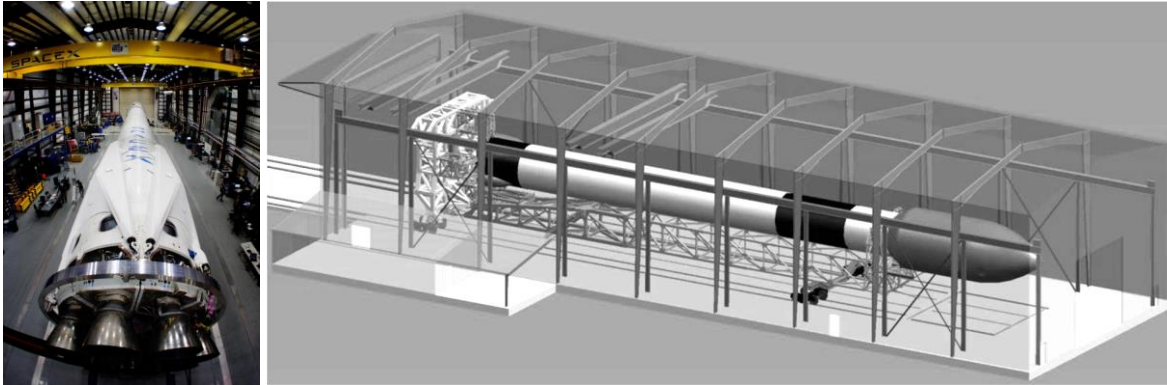

Figure 8-5: Integrated Falcon 9 on the transporter-erector within the integration hangar

## 8.5 Launch Operations

### 8.5.1 Organization

The main decision-making roles and responsibilities for launch operations are shown in Table 8-2. Note that this list is not inclusive of all stations participating in the launch, but, rather, is limited to those that have direct input in the decision-making process.

Table 8-2: Launch control organization

Position	Abbrev.	Organization
Mission director	MD	SpaceX (standard) Customer (nonstandard)
Mission manager	PM	SpaceX (mission manager)
Launch director	LD	SpaceX
Missile flight control officer, or flight safety officer	MFCO, or FSO	Launch Range
Operations safety manager, or ground safety officer	OSM, or GSO	Launch Range

The launch control organization and its lines of decision-making are shown in Figure 8-6. The details of the launch control organization are somewhat dependent on the mission and customer. The payload manager, or a payload manager representative, will sit at the payload station in the SpaceX launch control center alongside the SpaceX mission manager.

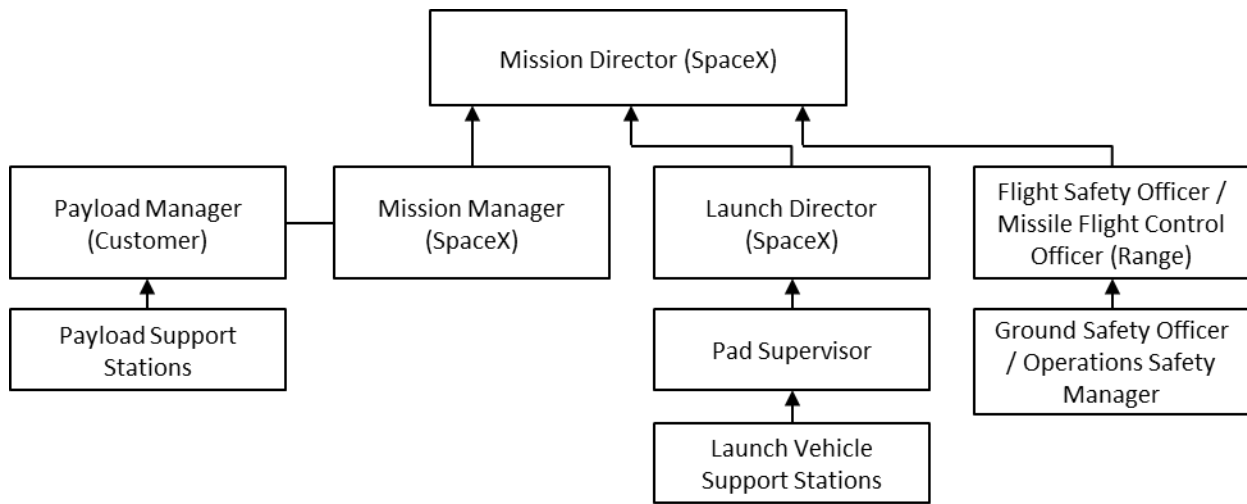

Figure 8-6: Launch control organization

### 8.5.2 Spacecraft Control Center

SpaceX provides a spacecraft control center for remote payload command and control operations during the launch countdown. Customer EGSE and spacecraft personnel will be located within the spacecraft control center during launch. The spacecraft control center includes full fiber-optic voice, video and Internet connectivity to the launch site, SpaceX Launch Control (Section 8.5.3), and other range facilities.

### 8.5.3 Launch Control

The SpaceX console design is modular, expandable and completely modern (Figure 8-7). SpaceX uses standard computer and display systems with software designed for industrial system control. Consoles also include voice communications capabilities, including voice nets, voice-over Internet protocol (IP) integration with remote sites, and IP phones. Video viewing and control are provided using the video-over-IP systems.

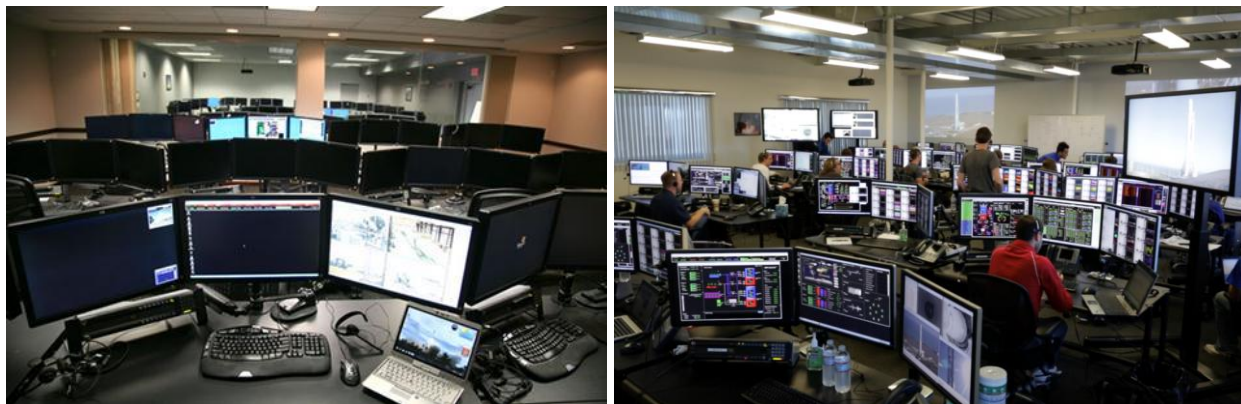

Figure 8-7: SpaceX launch control at CCAFS (left) and VAFB (right)

### 8.5.4 Rollout, Erection and Pad Operations

A rollout readiness assessment is conducted approximately one week prior to launch, in preparation for launch vehicle rollout. After readiness is verified, the integrated Falcon vehicle may be rolled out from the hangar to the pad on its transporter-erector (Figure 8-8). Once the vehicle is at the pad, the payload air conditioning system is reconnected, which helps maintain environmental control through liftoff. Electrical connectivity is provided via ground cables (Section 5.2.1). The vehicle will typically be erected only once, although the capability exists to easily return it to a horizontal orientation if necessary.



**Figure 8-8: Launch vehicle rollout and erection**

Customer access to the payload while the vehicle is outside of the hangar requires special accommodations and is a nonstandard service. Payload access is not available while the launch vehicle is vertical.

### 8.5.5 Countdown

Falcon 9 is designed to support a countdown duration as short as one hour; however, countdown durations as long as six hours may be implemented as a standard service at the customer's request. Early in the countdown, the vehicle performs LOX, RP-1 and pressurant loading, and it executes a series of vehicle and range checkouts. The transporter-erector strongback is retracted at T-6 minutes. Automated software sequencers control all critical Falcon vehicle functions during terminal countdown. Final launch activities include verifying flight termination system status, transferring to internal power, and activating the transmitters. Engine ignition occurs shortly before liftoff, while the vehicle is held down at the base via hydraulic clamps. The flight computer evaluates engine ignition and full-power performance during the prelaunch hold-down, and, if nominal criteria are satisfied, the hydraulic release system is activated at T-0. A safe shutdown is executed should any off-nominal condition be detected.

### 8.5.6 Recycle and Scrub

Falcon launch vehicle systems and operations have been designed to enable recycle operations when appropriate. Although every recycle event and launch window requirement is unique, Falcon vehicles offer the general capability to perform multiple recycles within a given launch window, eliminating unnecessary launch delays.

In the event of a launch scrub, SpaceX anticipates raising the transporter-erector strongback but remaining vertical on the pad. Remaining on the pad provides uninterrupted payload-to-EGSE connectivity through the T-0 umbilical, eliminating the need to relocate EGSE from the instrumentation bay to the hangar after a scrub. However, for any long-duration launch postponements, SpaceX will return the vehicle on the transporter-erector to the hangar.

## 8.6 Flight Operations

### 8.6.1 Liftoff and Ascent

First-stage powered flight lasts approximately three minutes, with commanded shutdown of the nine first-stage engines based on remaining propellant levels. The second stage burns an additional five to six minutes to reach initial orbit, with deployment of the fairing typically taking place early in second-stage powered flight. Subsequent operations are unique to each mission but may include multiple coast-and-restart phases as well as multiple spacecraft separation events.

### 8.6.2 Spacecraft Separation

After reaching the spacecraft injection orbit and attitude, the Falcon vehicle issues a spacecraft separation command, providing the electrical impulses necessary to initiate spacecraft separation. Indication of separation is available in second-stage telemetry.

### 8.6.3 Contamination and Collision Avoidance

If a contamination and collision avoidance maneuver is necessary, the second stage performs the maneuver shortly after separation. A contamination and collision avoidance maneuver is provided as a standard service for individual primary payloads. For multi-manifested and secondary payloads, please contact SpaceX regarding collision avoidance requirements.

### 8.6.4 Post Launch Reports

SpaceX will provide a quick-look orbit injection report to the customer shortly after spacecraft separation, including a best-estimate spacecraft separation state vector. A final, detailed postflight report is provided within eight weeks of launch.

### 8.6.5 Disposal

SpaceX makes every effort to mitigate space debris by responsibly passivating and disposing of hardware on orbit. Customer-specific requirements on disposal may impose modest reductions to the performance specifications indicated in Section 3.2.

### 8.7 Sample Mission Profile

A typical mission profile for a GTO mission is shown in Figure 8-9 and Table 8-3, and a sample timeline for a LEO mission is shown in Table 8-4. Note: each flight profile is unique and will differ from these examples.

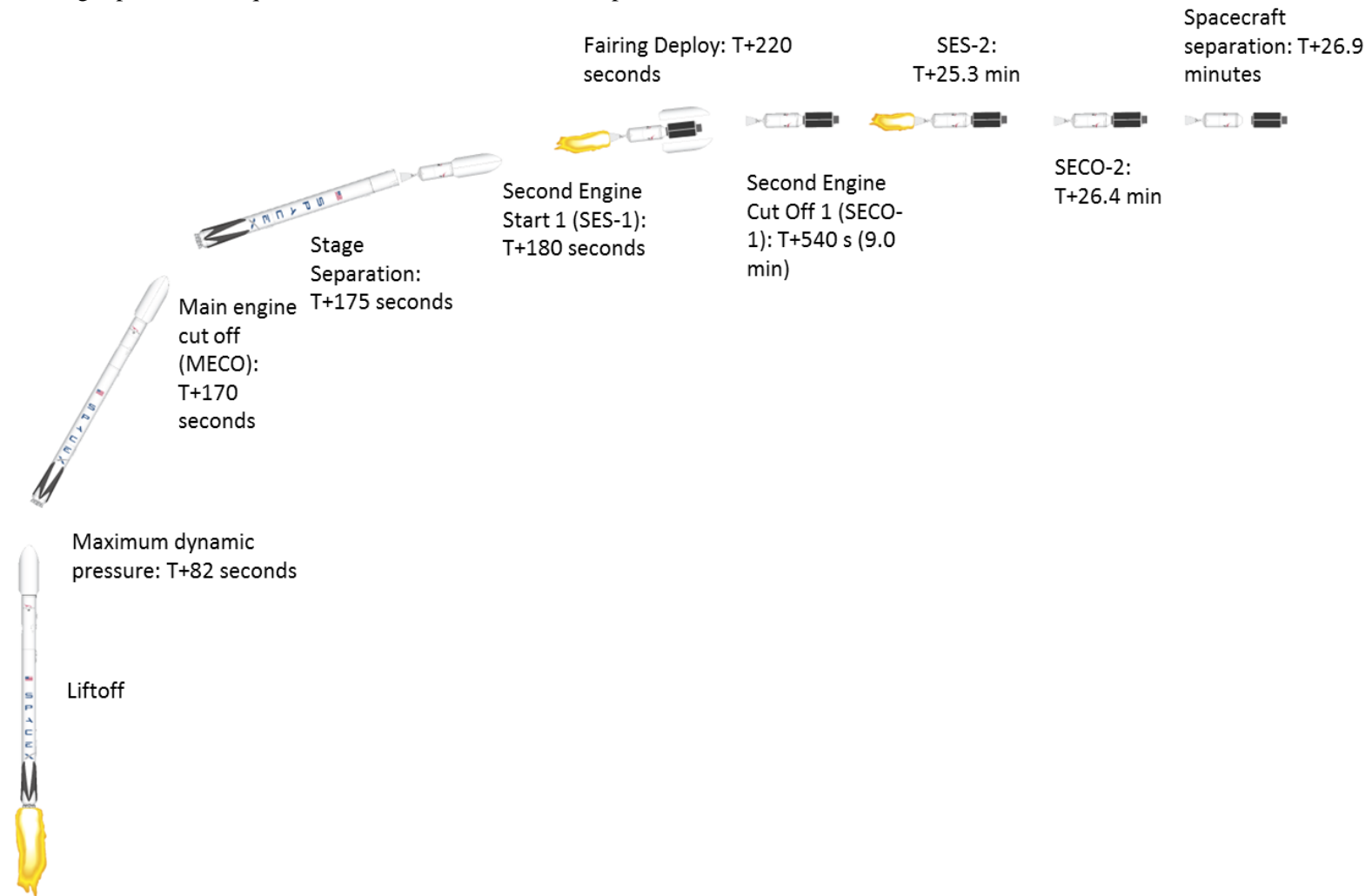

Figure 8-9: Falcon 9 sample mission profile—GTO mission

**Table 8-3: Falcon 9 sample flight timeline—GTO mission**

Mission Elapsed Time	Event
T - 3 s	Engine start sequence
T + 0	Liftoff
T + 82 s	Maximum dynamic pressure (max Q)
T + 170 s	Main engine cutoff
T + 175 s	Stage separation
T + 180 s (3.0 minutes)	Second engine start-1 (SES-1)
T + 220 s (3.7 minutes)	Fairing deploy
T + 540 s (9.0 minutes)	Second engine cutoff 1 (SECO-1)
T + 1,520 s (25.3 minutes)	Second engine start-2 (SES-2)
T + 1,585 s (26.4 minutes)	Second engine cutoff-2 (SECO-2)
T + 1,615 s (26.9 minutes)	Spacecraft separation

**Table 8-4: Falcon 9 sample flight timeline—LEO mission**

Mission Elapsed Time	Event
T - 3 s	Engine start sequence
T + 0	Liftoff
T + 82 s	Maximum dynamic pressure (max Q)
T + 170 s	Main engine cutoff
T + 175 s	Stage separation
T + 180 s (3.0 minutes)	Second-engine start-1 (SES-1)
T + 220 s (3.7 minutes)	Fairing deploy
T + 540 s (9.0 minutes)	Second-engine cutoff-1 (SECO-1)
T + 600 s (10.0 minutes)	Spacecraft separation

## 9. SAFETY

---

### 9.1 Safety Requirements

Falcon customers are required to meet AFSPCMAN 91-710 Range User's Manual and FAA 14 CFR Part 400 requirements in the design and operation of their flight and ground systems. These requirements encompass mechanical design, electrical design, fluid and pressurant systems, lifting and handling systems, ordnance and RF systems, ground support equipment, and other design and operational features. SpaceX will serve as the safety liaison between the customer and the range.

### 9.2 Hazardous Systems and Operations

Most ranges consider hazardous systems and operations to include ordnance operations, pressurized systems that operate below a 4-to-1 safety factor, lifting operations, operations or systems that include toxic or hazardous materials, high-power RF systems and laser systems, and a variety of other systems and operations. The details of the system design and its operation will determine whether the system or related operations are considered hazardous. Typically, additional precautions are required for operating systems that are considered hazardous, such as redundant valving between pressurant and propellant. Additional precautions will be determined during the safety approval process with SpaceX and the launch range. All hazardous operations require procedures that are approved by both SpaceX and the launch range prior to execution. Ordnance operations, in particular, require coordination to provide reduced RF environments, cleared areas, safety support and other requirements.

### 9.3 Waivers

For systems or operations that do not meet safety requirements but are believed to be acceptable for ground operations and launch, a waiver is typically produced for approval by the launch range safety authority. Waivers require considerable coordination and are considered a last resort; they should not be considered a standard practice.



## 10. CONTACT INFORMATION

---

If you are considering SpaceX launch services, please contact the SpaceX Sales department:

SpaceX  
Attention: Sales  
Rocket Rd.  
Hawthorne, CA 90250  
[sales@spacex.com](mailto:sales@spacex.com)

## 11. QUICK REFERENCE

### 11.1 List of Figures

Figure 1-1: SpaceX vehicles are designed for high cross-platform commonality .....	6
Figure 2-1 Falcon 9 Overview .....	10
Figure 2-2: Falcon vehicle coordinate frame .....	13
Figure 3-1: SpaceX payload attach fitting .....	15
Figure 3-2: Maximum allowable center-of-gravity height above the 1575-mm plane .....	15
Figure 4-1: Falcon 9 payload design load factors for “standard” mass (over 4,000 lb).....	20
Figure 4-2: Falcon 9 payload design load factors, Light mass (under 4,000 lb).....	21
Figure 4-3: Falcon 9 maximum axial equivalent sine environment.....	22
Figure 4-4: Falcon 9 maximum lateral equivalent sine environment.....	23
Figure 4-5: Falcon 9 maximum predicted acoustic environment (P95/50), 60% fill- factor, 131.4 dB OASPL (1/3 octave).....	24
Figure 4-6: Falcon 9 maximum predicted acoustic environment (P95/50), 60% fill- factor, 131.4 dB OASPL (full octave).....	25
Figure 4-7: Falcon 9 worst-case radiated environment.....	28
Figure 4-8: Falcon 9 RF susceptibility.....	29
Figure 4-9: Falcon 9 fairing internal pressure and decay rate (representative).....	30
Figure 4-10: Falcon 9 fairing internal pressure change, transonic spike (representative) .....	31
Figure 4-11: Maximum payload fairing spot temperature seen by payload .....	32
Figure 5-1: Falcon 9 payload interface ring (units are in inches) .....	35
Figure 5-2: Falcon 9 fairing and payload dynamic envelope, meters (feet) .....	36
Figure 5-3: On-pad electrical interfaces.....	39
Figure 6-1: Space Launch Complex 40 at Cape Canaveral Air Force Station, Florida .....	41
Figure 6-2: Layout of customer office space in Hangar X.....	42
Figure 6-3: SpaceX Launch Control facility layout.....	43
Figure 6-4: Space Launch Complex 4 East at Vandenberg Air Force Base, California .....	44
Figure 6-5: Vandenberg customer office space interior (left, center), exterior (right), and layout (bottom) .....	45
Figure 6-6: Pad customer room.....	45
Figure 6-7: Customer control rooms at SpaceX Launch Control .....	46
Figure 6-8: Hawthorne, California, headquarters .....	47
Figure 6-9: SpaceX Texas test facility and test operations .....	47
Figure 7-1: Mission management organization .....	48
Figure 8-1: Illustrative Falcon 9 processing, integration and launch operations schedule .....	53
Figure 8-2: VAFB payload processing facility and integration hangar layout .....	55
Figure 8-3: CCAFS payload processing facility layout.....	55
Figure 8-4: Payload encapsulation and integration sequence .....	57
Figure 8-5: Integrated Falcon 9 on the transporter-erector within the integration hangar .....	58
Figure 8-6: Launch control organization .....	59
Figure 8-7: SpaceX launch control at CCAFS (left) and VAFB (right) .....	59
Figure 8-8: Launch vehicle rollout and erection.....	60
Figure 8-9: Falcon 9 sample mission profile—GTO mission.....	62

## 11.2 List of Tables

Table 1-1: Falcon 9 safety features .....	7
Table 2-1: Falcon 9 dimensions and characteristics .....	11
Table 3-1: Falcon 9 launch services.....	14
Table 3-2: Orbit insertion accuracy .....	16
Table 4-1: Recommended quasi-static load factors for transportation .....	18
Table 4-2: Temperature and cleanliness environments.....	18
Table 4-3: Falcon 9 maximum predicted acoustic environment (P95/50), 60% fill- factor, 131.4 dB OASPL (1/3 octave) .....	24
Table 4-4: Falcon 9 maximum predicted acoustic environment (P95/50), 60% fill- factor, 131.4 dB OASPL (full octave).....	26
Table 4-5: Payload adapter-induced shock at the spacecraft separation plan .....	26
Table 4-6: RF systems characteristics.....	27
Table 4-7: Falcon 9 worst-case radiated environment .....	28
Table 4-8: Falcon 9 RF susceptibility .....	29
Table 4-9: Spacecraft environmental compatibility verification example .....	33
Table 5-1: Payload electrical interface connectivity .....	37
Table 5-2: Maximum expected cable lengths between payload racks/EGSE and the separation plane .....	38
Table 7-1: Standard launch integration schedule .....	50
Table 7-2: Required documents and data for all payloads .....	51
Table 7-3: Additional required documents and data for non-US persons and non-US government payloads.....	52
Table 8-1: Services and equipment for payload processing.....	56
Table 8-2: Launch control organization.....	58
Table 8-3: Falcon 9 sample flight timeline—GTO mission.....	63
Table 8-4: Falcon 9 sample flight timeline—LEO mission.....	63

## 11.3 List of Acronyms

AFSPCMAN.....	Air Force Space Command Manual
ATSB .....	Astronautic Technology Sdn Bhd (Malaysia)
AWG.....	American wire gauge
BPSK .....	binary phase shift keying
C3.....	characteristic energy (escape energy)
CAD.....	computer-aided design
CCAFS .....	Cape Canaveral Air Force Station
CDR.....	critical design review
COTS .....	Commercial Orbital Transportation Services
CRS.....	Commercial Resupply Services
DSSS .....	direct-sequence spread spectrum
EELV .....	evolved expendable launch vehicle
EGSE .....	electrical ground support equipment
ESPA.....	EELV secondary payload adapter

FAA .....	Federal Aviation Administration
FM.....	frequency modulation
GN <sub>2</sub> .....	gaseous nitrogen
GPS .....	Global Positioning System
GSE.....	ground support equipment
GTO .....	geosynchronous transfer orbit
HVAC .....	heating, ventilation and air conditioning
ICD.....	interface control document
IMS .....	integrated master schedule
IRIG .....	inter-range instrumentation group
LCC.....	launch control center
LEO.....	low Earth orbit
LOX .....	liquid oxygen
LTAN.....	local time of ascending node
LV .....	launch vehicle
LVLH.....	local vertical/local horizontal
Max-Q.....	maximum dynamic pressure
MECO.....	main engine cut-off
MPE .....	maximum predicted environment
NASA.....	National Aeronautics and Space Administration
OASPL .....	overall sound pressure level
PCM.....	pulse code modulation
PDR.....	preliminary design review
PPF.....	payload processing facility
PM.....	phase modulation
P-POD .....	Poly-Picosatellite Orbital Deployer
PSK .....	phase shift keying
Q.....	dynamic pressure
QD.....	quick-disconnect
RAAN .....	right ascension of the ascending node
RF.....	radio frequency
RH.....	relative humidity
RP-1 .....	rocket propellant-1 (rocket-grade kerosene)
RPM.....	rotations per minute
RTS .....	Reagan Test Site
SC.....	spacecraft
SCAPE.....	self-contained atmospheric protective ensemble
SECO .....	second-engine cut-off
SES.....	second-engine start
SI.....	International System of Units
SLC .....	space launch complex
SpaceX.....	Space Exploration Technologies Corp.
SPL.....	sound pressure level
SRS .....	shock response spectrum

SSO .....sun-synchronous orbit  
T-E .....transporter-erector  
TEA-TEB ..... triethylaluminum-triethylborane  
US ..... United States  
UTC .....Coordinated Universal Time  
VAFB..... Vandenberg Air Force Base